

Factors Affecting Cadmium Uptake and Distribution in Barley

Merrine Thomas

Department of Ecology and Environmental Sciences,
School of Biological Sciences

Submitted for fulfilment of the degree of
Doctor of Philosophy

The University of Adelaide
May 2019

Table of Contents

iv. Abstract

vi. Declaration

vii. Acknowledgements

1. Introduction

- 1.1. Literature Review
- 1.2. Contextual Statement
- 1.3. Research Aims and Objectives
- 1.4. Thesis Structure

2. Factors affecting the uptake of cadmium into barley

- 2.1. Effect of micronutrient deficiency on the influx of Cd
- 2.2. Effect of Fe nutrition on the uptake of Cd and the competition between Cd and FeII
- 2.3. Effect of mild Fe deficiency on the uptake of Cd, and the competition between Cd and FeIII
- 2.4. Effect of Cd on the influx of ⁵⁵FeIII
- 2.5. Effect of micronutrients on the influx of ⁵⁵FeIII
- 2.6. Effect of the presence of micronutrients and micronutrient deficiency on the influx of ⁵⁵FeIII
- 2.7. Cd influx into whole roots under different nutrient conditions
- 2.8. Competition between Cd and micronutrient metals
- 2.9. Effect of deficiencies on long-term accumulation of Cd

3. Factors affecting the uptake of nickel into barley

- 3.1. Effect of Fe nutrition on influx of Ni and the competition between Ni and FeII
- 3.2. Effect of mild Fe deficiency on influx of Ni and the competition between Ni and FeIII
- 3.3. Competition between Ni and micronutrient metals
- 3.4. Effect of different micronutrient deficiencies on influx of Ni
- 3.5. Effect of deficiencies on long-term accumulation of Ni

4. Transport of Cd and Ni in shoot protoplasts

- 1.1. Comparison of Cd and Fe uptake in Fe-sufficient and Fe-starved plants
- 1.2. Comparison of Cd and Fe uptake in non-deficient and Mn, Zn & Cu starved plants
- 1.3. Competition between Cd and micronutrient metals
- 1.4. Competition between Ni and micronutrient metals
- 1.5. Effect of nutrient status on the uptake of Cd into shoot protoplasts
- 1.6. Effect of nutrient status on the uptake of Ni into shoot protoplasts

5. Cd distribution between cytoplasm and vacuole

- 5.1. The effect of ATP with and without GSH on the uptake of Cd into vacuoles
- 5.2. The effect of GSH with and without ATP on the uptake of Cd into vacuoles
- 5.3. Competition with Zn
- 5.4. Competition with Mn
- 5.5. Cd compartmentation in protoplasts – short-term exposure to Cd
- 5.6. Cd compartmentation in protoplasts – long-term exposure to Cd

6. Cd mobility within the plant and Cd efflux from roots

- 6.1 Cd distribution following root uptake
- 6.2 Cd distribution following foliar application
- 6.3 Cd efflux

7. General Discussion

Bibliography

Abstract

Crop plants often accumulate heavy metals to concentrations that exceed recommended food standard guidelines. Cadmium (Cd) is particularly problematic because of its high toxicity and its ability to be accumulated and retained in kidney and bones for decades. In most cases, reduction in the concentration of toxic metals in soil is impractical, so plant-based strategies aimed at restricting Cd accumulation in edible plant parts need to be considered. What follows is a study of the factors that affect the uptake and distribution of Cd within a representative cereal, barley (*Hordeum vulgare* cv. Schooner). Since Cd is a non-essential metal in plants, the transport characteristics were compared with those of an essential micronutrient, Ni in a series of supplementary experiments.

The effects of nutrient status and cation competition on Cd uptake were investigated to analyse the main route for Cd entry into the plants. Cd uptake into whole plants (hydroponically grown) was measured by radiotracer studies and elemental analysis. Fe and Zn were found to have large effect on the uptake of Cd both via deficiencies and by the competition for uptake. This strongly suggests that the main route for Cd uptake is via Fe and Zn transporters. The inhibition of Cd influx only by FeII (but not by FeIII) suggests that Cd uptake into the root occurs through divalent cation transporters. At the same external concentration more than twice as much Cd was absorbed as Ni. Ni translocation to the shoot was also much lower than for Cd. The transport studies on protoplasts showed that transporters in the shoot respond to plant nutrient status but differently to that of the root.

Comparison of the concentrations of ^{109}Cd in whole protoplasts and vacuoles isolated from shoots demonstrated that the majority of the cellular Cd was located in the vacuole. In vacuolar transport assays, the addition of ATP alone significantly increased Cd uptake into the vacuole, but more so when both ATP and GSH were supplied together. This suggests that Cd may be partly sequestered as Cd^{2+} ions via divalent cation transporters, but predominantly as Cd-GSH complexes, most likely via ABC-type transporters.

Cd distribution within the plant was investigated following ^{109}Cd supplied through the roots or applied to individual leaf surfaces. The preferential movement of Cd to the tip of the youngest leaf was noticed in both cases. Following foliar application, a significant amount of Cd was rapidly distributed to roots instead of shoots. Over 48 h, 12% of this root Cd was

effluxed into the external solution. This active excretion may be a detoxification strategy, in addition to sequestration into vacuoles. The bidirectional movement of Cd within the plant indicates that Cd is highly mobile in both xylem and phloem.

This study has provided a detailed picture of the movement of Cd in barley at various levels. Prevention of Fe and Zn deficiencies and higher Fe/Zn nutrition levels should reduce Cd accumulation.

Declaration

I certify that this work contains no material which has been accepted for the award of any other degree or diploma in my name, in any university or other tertiary institution and, to the best of my knowledge and belief, contains no material previously published or written by another person, except where due reference has been made in the text. In addition, I certify that no part of this work will, in the future, be used in a submission in my name, for any other degree or diploma in any university or other tertiary institution without the prior approval of the University of Adelaide and where applicable, any partner institution responsible for the joint-award of this degree.

I acknowledge the support I have received for my research through the provision of an Australian Government Research Training Program Scholarship

I give consent to this copy of my thesis, when deposited in the University Library, being made available for loan and photocopying, subject to the provisions of the Copyright Act 1986.

I give permission for the digital version of my thesis to be made available on the web, via the University's digital research repository, the Library Search and also through web search engines, unless permission has been granted by the University to restrict access for a period of time.

Merrine Thomas

.....

Signed

Acknowledgements

First and foremost, all praise, glory and thanks to God, the Almighty, for providing me with this precious opportunity, and for all His mercies and grace that I experienced enormously throughout in my research and my life. “This also comes from the LORD of hosts, who is wonderful in counsel and excellent in guidance.” Isaiah 28:29

I would like to express my heartfelt thanks, sincere gratitude and a very great appreciation to my Principal supervisor Prof. Rob Reid for his continuous and generous support of my PhD study. I consider it my privilege to have had Prof. Rob Reid as my supervisor. His support has been constant from the start of this research until the final form of this thesis. Without his guidance and mentoring, this work would not have progressed to the current form. He has deeply motivated me by setting an example as a passionate and enthusiastic researcher. I am truly grateful for all his efforts to make my research more productive and vibrant even in the toughest phase of my research.

I would like to thank Prof. Justin Brookes for all his valuable advice, continuous encouragement and support throughout this study. I would also like to thank Dr Steven Delean for his advice and help in keeping my progress on schedule.

My special thanks are extended to all my friends especially Xavier, Antoine and Patrick for their help and support.

A special thanks to my cousin Anita and my friend Helen for their immense moral support and their sincere prayers especially in my difficult times.

I have no words to express how grateful I am to my parents, parents-in-law and my siblings for their great support, constant encouragement and heartfelt prayers. My mother, who was my biology teacher, has kindled the love for science in me. My father has encouraged and challenged me to pursue deeper meanings of life. They are my wonderful teachers. I am particularly thankful to my mother-in-law for her great support in the initial phase of this work.

Finally, this endeavour would not have been possible without the great support and sacrifices of my husband, Bobby and our daughter, Neethi. I am truly indebted to them for putting up with me for all through these years especially when I had to spend very long days in the lab. My very special thanks to them!

Chapter 1

1. Introduction

1.1 Literature Review

1.1.1 Heavy metals and pollution

Heavy metal contamination is a serious environmental problem that can have detrimental impacts on human health. The primary sources which contribute to the present level of metal pollution include burning of fossil fuels, mining and smelting of metalliferous ores, pesticides, downwash from power lines, fertilisers, sewage and the inappropriate disposal of residual waste (Migeon et al., 2010). The impacts of heavy metals on human health can occur due to food intake, long-term exposure and occupational exposure to metals in the environment. The toxic metal accumulation in edible portions of food crops is the major pathway of metal entry into the food chain (Clemens, 2006). Heavy metals can affect human health by causing or exacerbating various types of cancer, myocardial infarction, diminished lung function, diabetes and hypertension (Mendoza-Cózatl et al., 2010).

Iron (Fe), copper (Cu), manganese (Mn), zinc (Zn), nickel (Ni), and cobalt (Co) are heavy metals known to be essential micronutrients for plant metabolism, but they can be highly toxic when present in excess (Williams et al., 2000). Non-essential heavy metals such as lead (Pb), cadmium (Cd) and mercury (Hg) are extremely toxic even if taken in at low concentrations due to their reactivity with S and N atoms in amino acid chains, and they have no biological functions (Clemens, 2001; Schneider et al., 2009). These non-essential elements can alter the functions of essential micronutrients by displacing essential metals from their functional binding sites in proteins, which then alters the biochemical and physiological functions (Verbruggen et al., 2009; Mendoza-Cózatl et al., 2010). Among these metals, Cd is of particular concern to human health because of its high toxicity. Plant roots can readily absorb Cd and it thus gets bio-accumulated in the food chain (Clemens, 2006).

Many heavy metals are highly reactive and their accumulation at high concentrations can damage plant metabolism (Mendoza-Cózatl et al., 2010). This applies

to both non-essential metals as well as essential metals. As a result, the concentrations of these metals within cells need to be controlled effectively, and so living organisms including plants possess a range of metal homeostatic mechanisms, mostly based around membrane transport processes and intracellular complexation (Hall and Williams, 2003).

1.1.2 Heavy metal homeostasis mechanisms in plants

Plants like other organisms have developed various mechanisms to keep the concentration of essential nutrients within physiological limits and to minimise the hazardous impacts of non-essential metals (Clemens, 2001). The different components involved in metal homeostasis mainly involve transport, chelation and sequestration processes (Clemens, 2001). The ability of plants to grow on metal contaminated soil depends on their tolerance to metals at the cellular level, which is based on various detoxification mechanisms such as cell wall binding, chelation by protective ligands and active export from the cytoplasm, either back to the external medium, or more commonly into the vacuole (Hall, 2002; Migeon et al., 2010). Metal transporters have an important role in plant metal homeostasis as they are involved in the uptake and transport of metals to various plant organs and cell types, storage of metals and its remobilisation (Kramer et al., 2007). However, some of these transporters have poor selectivity, so they take up non-essential metals also along with essential metals (Korshunova et al., 1999; Thomine et al., 2000; Clemens et al., 2002; Hall and Williams, 2003; Palmgren et al., 2008). For example, Cd uptake from the soil appears to take place mostly through Ca, Fe, Mn and Zn transporters/channels of low specificity (Clemens, 2006; Herbette et al., 2006; Verbruggen et al., 2009; Clemens and Ma, 2016).

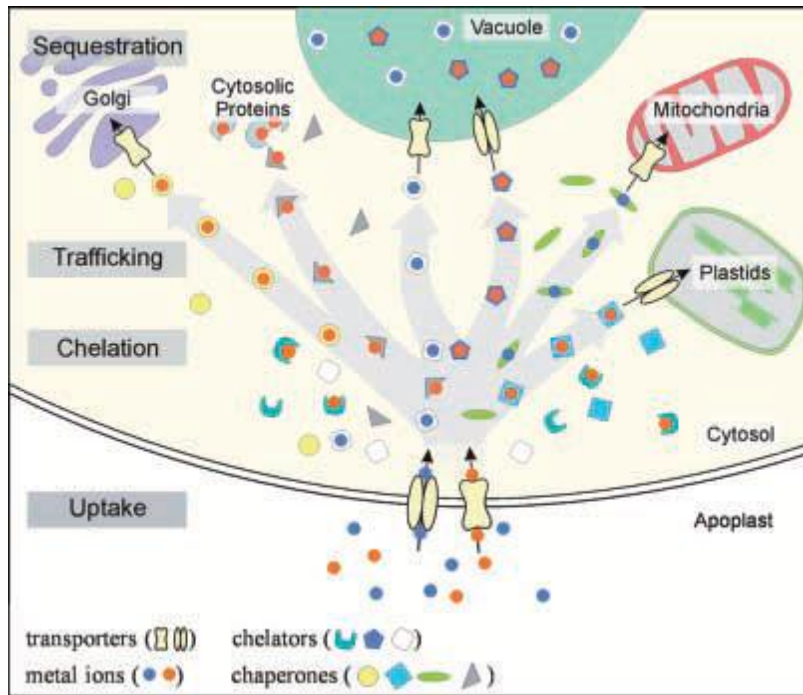

Figure 1.1: Simplified hypothetical scheme of the cellular plant metal homeostasis network (Clemens, 2001).

Steps involved:

1. Uptake through transporters.
2. Chelators and chaperones bound with metal ions
3. Chelators buffer cytosolic metal concentrations and chaperones involves in metal trafficking
4. The delivery of essential metal ions specifically to metal requiring cytosolic proteins and to organelles.
5. Uptake into the organelles is catalysed by metal-ion pumps that directly interact with specific chaperons
6. Detoxification and storage of excess metals through vacuolar sequestration

1.1.3 Uptake and efflux of heavy metals through the plasma membrane

The first step involved in plant metal homeostasis is the uptake of metals through metal transporters on the plasma membrane. A balance between both uptake and efflux is necessary to effectively regulate internal metal concentrations (Colangelo and Guerinot, 2006). The availability of a particular metal for plant uptake (bioavailability) is directed by a multifaceted interaction between the composition and physiochemical properties

of the soil, the chemical properties of the metal cations, microbial activity and plant roots (Palmgren et al., 2008). Plant roots can play a role in making the metal ions more available to the transporters for uptake by acidifying the rhizosphere, or by the secretion of chelating agents. For metals, an important class of chelators are the phyto siderophores (PS) which have varying affinities for both essential and non-essential metals, including Cd (Clemens, 2006). Shenker et al. (2001) have suggested that there is no significant uptake of the Cd-PS complex by the plant roots, even though Cd might be mobilised by PS. According to Kudo et al. (2007), the main function of PS might be the collection of Cd to the rhizosphere, which helps in the enhancement of the concentration of Cd in the rhizosphere.

The uptake of metal ions is a passive process in most cases, through specific transporters. This process is passive mainly because of the membrane potential, which is negative on the inside of the plasma membrane and therefore creates a very powerful driving force for the influx of cations through channel proteins and carrier proteins (Clemens et al., 2002).

1.1.4 Ion Channels

Ion channels in the plasma membrane are used for the uptake of several important nutrient metals, most notably K and Ca. These channels have been shown to also leak other metals such as Na, Cu, Mn, Co, Ba, Ni, Zn and Cd (White et al., 2000). Perfus Barbeoch (2002) showed that Cd competed with Ca for permeation through guard cell cations channels, while Pineros and Kochian (2003) reported that Zn influx could take place through non-selective cation channels in the Zn hyperaccumulator *Noccaea caerulea* (*Thlaspi caerulea*).

1.1.5 Carrier proteins

Carrier proteins or transporters have a significant function in the transport of heavy metals as they mediate the uptake of metal ions (Clemens et al., 2002). During the past decade, numerous families of metal transporters involved in the uptake and transport of essential metals have been identified and characterised, aided by technical advancements in molecular biology. (Clemens et al., 2002; Hall and Williams, 2003;

Colangelo and Guerinot, 2006). Kramer et al. (2007) formulated a list of families of known proteins that mediate the transport of transition metals in plants:

- ZIP (Zinc regulated and Iron regulated transporter Protein)
- CDF (Cation Diffusion Facilitator)
- P-type ATPases
 - Subfamily-P1B-type
- NRAMP (Natural Resistance Associated Macrophage Protein)
- OPT (Oligopeptide Transporter)
 - Subfamily YSL (yellow-stripe-1-like)
- COPT (Copper Transporter)
- CCC1 (Ca²⁺-sensitive Cross Complementer1)
- IREG (Iron Regulated Protein)
- CAX (Cation exchanger)
- ABC (ATP-Binding Cassette transporter) transporters
 - Subfamily 1: MRP (Multidrug Resistance-associated Proteins)
 - Subfamily 2: ATP (ABC Transporters of Mitochondria) transporters
 - Subfamily 3: PDR (Pleiotropic Drug Resistance) transporters

Internal nutrient status and plant development are considered to be the main factors regulating plant membrane transporters. For example, the expression of IRT1, which is known to transport FeII across the plasma membrane of epidermal cells in roots (Korshunova et al., 1999; Vert et al., 2002) is strongly upregulated under Fe deficiency (Eide et al., 1996). However, Fe deficiency induces uptake of other heavy metals including Mn, Zn, Co and Cd for which IRT1 is suspected of being responsible (Cohen et al., 1998; Vert et al., 2002).

The ZIP proteins are ubiquitous and mostly function in the transport of Zn (Grotz and Guerinot, 2006). When expressed in yeast, Zn transport by ZIPs is variously inhibited by Mn, Co and Cd (Grotz et al., 1998), which suggests that ZIPs are capable of the transport of these metals as well. In Arabidopsis, ZIP2 and ZIP4 respond to Cu deficiency, and when expressed in yeast these genes can complement mutants defective in Cu transport (Wintz et al., 2003).

NRAMP proteins are widely distributed and capable of transporting a range of divalent metals including Cd (Gunshin et al., 1997; Chen et al., 1999). YSL proteins are also thought to be responsible for the transport of heavy metals including Fe, Zn, Cu, and Ni (Roberts et al., 2004; Schaaf et al., 2004).

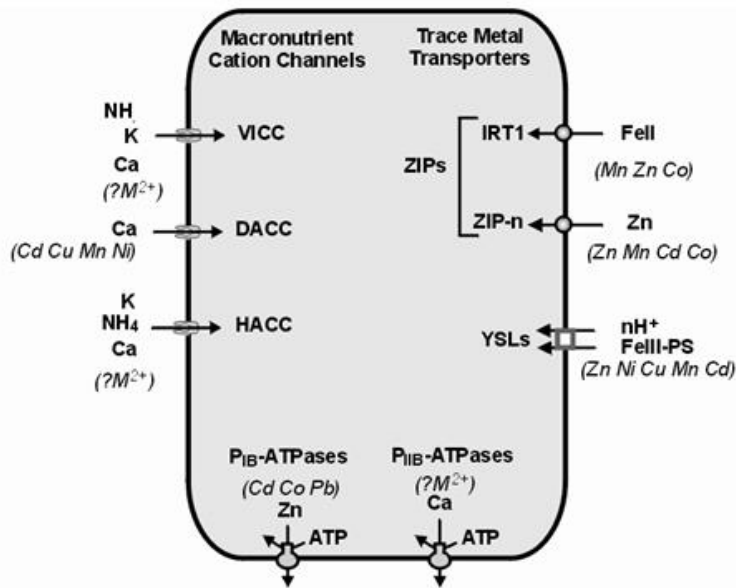

Figure 1.2: Main transporters on the plasma membrane of plant cells with known or suspected roles in heavy metal transport: The likely primary substrates are shown in bold and secondary or unintentional substrates in italics. ‘M’ designates the unidentified divalent cations. VICC- Voltage Insensitive Cation Channel; DACC- Depolarisation Activated Cation Channel; HACC-Hyperpolarisation Activated Cation Channel (Reid, unpublished).

1.1.6 Efflux Pumps

Active pumping of metals out of the cytosol through the plasma membrane is a potential mechanism for heavy metal detoxification in plants. P_{iB} ATPases play a role in Ca homeostasis by pumping Ca out across the plasma membrane (Hetherington and Brownlee, 2004). There is evidence that ABC-type-transporters can also mediate the efflux of Cd (Li et al., 2002; Kim et al., 2008), supported by apparent Cd efflux in wheat (Lindberg et al., 2007; Kim et al., 2008) and cucumber (Burzyński et al., 2005).

1.1.7 Detoxification by chelation in the cytosol

Chelation of metals in the cytoplasm is one of the important mechanisms of heavy metal homeostasis and detoxification. Phytochelatins, glutathione (GSH), metallothioneins, organic acids and amino acids are the main chelating agents, with high-affinity ligands capable of binding to heavy metals (Cobbett and Goldsbrough, 2002; Hall, 2002). For Cd, the most common chelating agents are small peptides comprised of amino acids containing thiol (-SH) groups. The simplest of these peptides is glutathione (Glu-Cys-Gly), which serves as the base for larger phytochelatins containing multiple thiol groups and hence higher affinities for Cd. These peptides are not formed by protein translation but are synthesised enzymically. Glutathione is synthesized by gamma-glutamylcysteine synthetase (γ -GCS) and glutathione synthetase (GS). It can bind to metals and metalloids and has been shown to play a vital role in alleviating Cd-induced oxidative stress (Gill and Tuteja, 2011). Phytochelatins are glutathione-derived peptides and are involved in the detoxification and storage of heavy metals in plants and fungi (Zenk, 1996). Phytochelatins are synthesised by the action of phytochelatin synthase (PCS) via a transpeptidation reaction in the cytoplasm (Grill et al., 1989; Rea et al., 2004; Mendoza-Cózatl et al., 2010). The ability to induce phytochelatin synthesis by exposure to heavy metals appears to be widely distributed in angiosperms. For example, Semane et al., (2007) demonstrated that Cd can induce both GSH and PC synthase genes in *Arabidopsis thaliana*. More generally, it is observed that phytochelatin synthesis is mostly mediated by exposure to Cd and to a lesser extent Cu, and much less by other heavy metals, with the degree of phytochelatin synthesis related to Cd tolerance (Ernst et al., 2008). Once formed, the phytochelatin-metal complexes appear to then be transported into vacuoles, but can also undergo long-distance transport between roots and shoots (Mendoza-Cózatl et al., 2010).

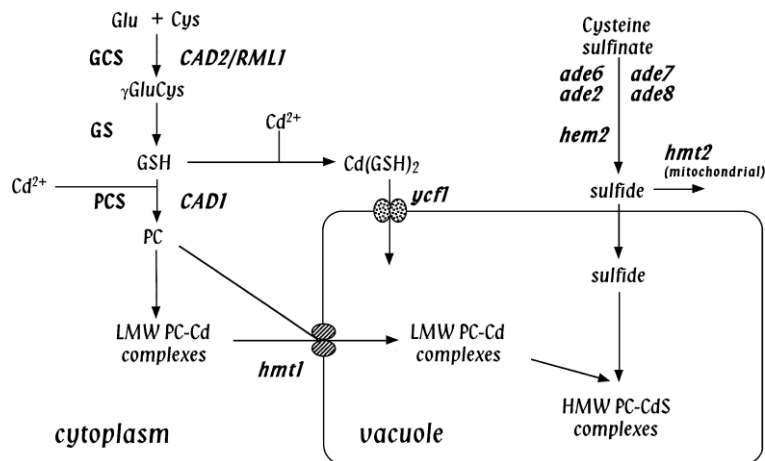

Figure 1.3: Genes and functions which contribute to Cd detoxification in plants and fungi. Many of these functions were identified through the isolation of Cd-sensitive mutants. Gene loci are shown in italics: *CAD1* and *CAD2/RML1* are in *Arabidopsis*; *hmt1*, *hmt2*, *ade2*, *ade6*, *ade7*, and *ade8* are in *S. pombe*; *ycf1* is in *Saccharomyces cerevisiae*, and *hem2* is in *Candida glabrata*. Enzyme abbreviations: GCS, γ -glutamylcysteine synthetase; GS, glutathione synthetase; PCS, phytochelatin synthase (Cobbett and Goldsbrough, 2002).

1.1.8 Detoxification by vacuolar sequestration

Plants have developed different strategies to prevent the flooding of the cytoplasm with toxic metals. While efflux from the cell is an option, it is energetically expensive due to the need to pump positive ions against the large inward electrochemical gradient that exists across the plasma membrane. The alternative is to pump excess metals into the vacuole which is only slightly more positive than the cytoplasm (Martinoia et al., 2007), and therefore the energy required is much less. The transporters on the vacuolar membrane transport these heavy metals either free or conjugated into the vacuole by a process known as vacuolar sequestration (Martinoia et al., 2000; Van Belleghem et al., 2007; Morel et al., 2009; Song et al., 2010; Ueno et al., 2010). In some cases, these metals are initially chelated by thiol compounds such as glutathione and phytochelatin in the cytoplasm, and then the entire metal complex is sequestered into the vacuole (Martinoia et al., 2000; Verbruggen et al., 2009).

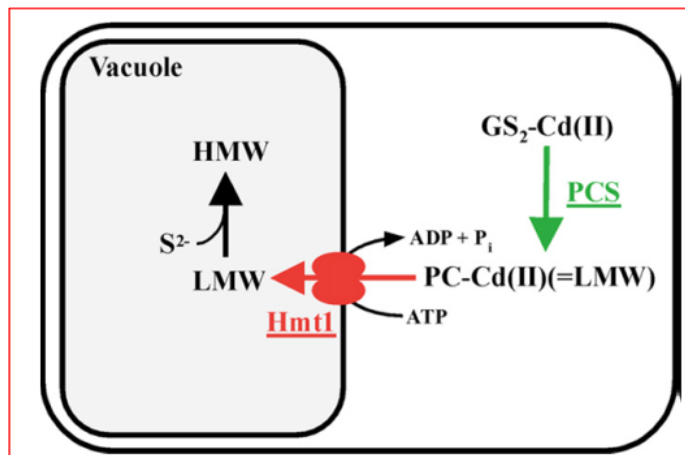

Figure 1.4: A mechanism for the vacuolar sequestration of Cd–PC complexes. Low molecular weight (LMW) PC-Cd complexes are formed in the cytosol which is mediated by the activity of PCS (phytochelatin synthase). The ABC-type transporter (Hmt1) transports these complexes into the vacuole, where more Cd and sulphide are incorporated to make the high molecular weight complexes in *Schizosaccharomyces pombe* (from Clemens, 2006).

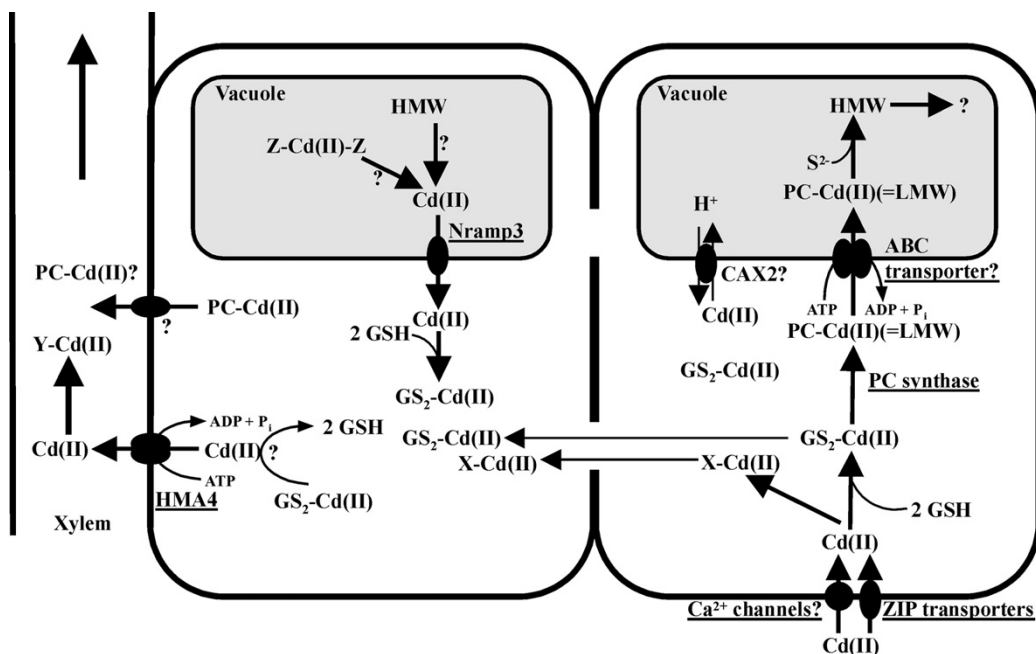

Figure 1.5: Schematic representation of processes involved in the uptake, sequestration and translocation of Cd in plant roots. Two root cells are shown: one is facing the rhizosphere (right), one is adjacent to the xylem (left). These two cells are connected (simplistically) through plasmodesmata. Transporters/channels of essential metal ions

take up Cd^{2+} ions. These ions in the cytosol are most likely chelated by initial ligands (GSH (bisglutathionato–Cd complexes, $\text{GS}_2\text{-Cd (II)}$) and other unknown molecules -X-Cd (II)). Phytochelatin synthase acts upon $\text{GS}_2\text{-Cd (II)}$ to form PC-Cd (II) complexes (low molecular weight complexes), which are sequestered into the vacuole by an ABC-type transporter. High molecular weight complexes are formed by incorporating more Cd^{2+} ions and sulphide in the vacuole. $\text{Cd}^{2+}/\text{H}^+$ antiport may be an alternative way of vacuolar sequestration. CAX2, principally a transporter for Ca, appears to be a possible transporter of Cd. It seems that a fraction of this sequestered Cd gets remobilized back into the cytosol by NRAMP proteins. Translocation of Cd into the xylem is through efflux pumps (HMA4) present in the plasma membrane of surrounding cells (from Clemens, 2006).

1.1.9 Factors that affect the uptake and transport of Cd

A number of heavy metals are essential for plant growth, and their uptake depends on many factors. The relative concentrations of each competing metals and nutrient status of the plant are considered to be the major factors that determine the uptake of both essential and non-essential metals including Cd. There are many instances from the literature where the importance of these two factors has been ignored, most notably in the use of unrealistically high concentrations of heavy metals. The low-specificity of transporters for essential metals is known to be a significant contributor to Cd uptake (Korshunova et al., 1999; Clemens, 2006; Grotz and Guerinot, 2006). Competition between Cd and other cations for uptake has been reported in various studies (e.g. Hart et al., 2002; Chen et al., 2007), and therefore the concentration of Cd relative to these other cations is likely to determine how much Cd is actually absorbed.

Internal nutrient status of the plant, especially nutrient deficiency, is considered to be a governing factor in the regulation of membrane transporters. Under micronutrient deficiency, synthesis of higher affinity transporters for the micronutrient that is deficient appears to be induced. These transporters can mediate the uptake of other cations including Cd as they often have poorer selectivity than those that operate at the normal nutrient conditions. For this reason, the micronutrient status of the plant can also significantly affect the uptake and transport of Cd.

Unfortunately, the majority of transport studies on Cd uptake (e.g. Lombi et al., 2002;; Sharma et al., 2004; Bao et al., 2009; Astolfi et al., 2012; Sghayar et al., 2015) used high concentrations of Cd (25-50 μM) that greatly exceed levels found even in highly contaminated soil. In agricultural soils, it is rare for heavy metals to be found at concentrations that are toxic to plant growth. Cd is generally in the range of 0.01-1.0 mg kg^{-1} (in the nanomolar range) in agricultural soils, which is considered to be a low level (McLaughlin et al., 1999; Dong et al., 2001; Nolan et al., 2003; Zarcinas et al., 2004). Cd concentrations in contaminated soils are usually in the range of 0.1 - 38 mg kg^{-1} (Sauvé et al., 2000). Therefore, the studies that use high concentrations of Cd are likely to give distorted views of the uptake characteristics of the metal.

Several studies have demonstrated that enhanced Cd uptake has been linked to Fe deficiency in several species including rice (Shao et al., 2007; Rodda and Reid, 2013; Su et al., 2013). Studies on rice using mutants have implicated Fe transporters (OsNRAMP1 and OsNRAMP5) in Cd uptake (Takahashi et al., 2011; Ishimaru et al., 2012). Other studies found interactions between Cd and Zn transport (Satoh-Nagasawa et al., 2012; Takahashi et al., 2012; Brennan and Bolland, 2014).

In contrast to the stimulative effect of Fe deficiency on root uptake of Cd, a study has shown that Fe deficiency inhibits Cd translocation in peanut (Su et al., 2013). The response of shoot transporters to various factors is poorly understood, and little is known about the expression of Fe, Mn and Zn transporters (most belonging to the ZIP and NRAMP families), in shoots (Pedas et al., 2008; Pedas et al., 2009).

1.1.10 Factors that affect the uptake and transport of Ni, an essential metal

Ni is an essential micronutrient for plant growth, but plants require only a trace amount of Ni and excess amount can be toxic to plants. The Ni content in soil may vary, normally ranging from 0.2 mg kg^{-1} to 450 mg kg^{-1} (Ahmad and Ashraf, 2012). As a result of environmental pollution due to anthropogenic activities, Ni concentrations in polluted soil can increase by 20 to 30 fold (200-26,000 mg kg^{-1}) higher than normal soil (Sreekanth et al., 2013; Gupta et al., 2017; Rizwan et al., 2018). Excess Ni can be toxic and cause adverse effects on human health affecting the central nervous system and digestive tract; children are more vulnerable to the health risks associated with Ni than adults (Luo et al., 2017). For most populations, the source of Ni is mainly through their dietary

intake (De Brouwere et al., 2012; Chain, 2015; Luo et al., 2017). Food safety problems associated with Ni were recorded in the report of the European Food Safety Authority in 2015 (Benford et al., 2015). A recent survey showed that rice, legumes and root crops contain the highest Ni concentration (Luo et al., 2017).

As Ni is an essential nutrient for plant growth, some physiological mechanisms may be involved in the uptake of Ni and its transport and it is reasonable to speculate that specific Ni transporters are likely to be involved in these transport processes. However, physiological mechanisms underlying the Ni transport in plants are far from being fully understood. Luo et al. (2017) highlighted the importance of plant physiological studies on the uptake and distribution of Ni. The various factors that influence the uptake of Ni in plants include the concentration of Ni, plant metabolism, the acidity of soil or solution, the concentration of other metals, and organic matter composition (Chen et al., 2009).

The relative concentration of competing metal species is an important factor that also affects Ni transport. However, the effect of other micronutrients on the uptake of Ni is not an extensively studied topic. In soybean seedlings, a study reported that Cu and Zn competed with Ni for uptake (Cataldo et al., 1978), suggesting that they share the same transport systems. The nutrient status of the plant, mainly micronutrient deficiency, can also significantly affect the uptake characteristics of Ni. In *Arabidopsis thaliana*, a couple of studies have shown an increase in Ni accumulation in Fe-deficient plants (Schaaf et al., 2006; Nishida et al., 2011), consistent with Ni uptake via Fe transporters. In addition, Nishida et al., (2015) showed that Zn deficiency also induces Ni absorption in roots of *Arabidopsis thaliana* and addition of Zn inhibits Ni uptake. However, these studies used much higher concentrations of Ni (25-30 μM), which gives an unrealistic picture of the uptake characteristics of the metal.

1.1.11 The vacuole and its role in heavy metal homeostasis

The central vacuole is the largest organelle in a plant cell, and it can occupy more than 80% of the cell volume in a mature plant cell. It is separated from the cytoplasm by a single semi-permeable membrane, which is otherwise known as the tonoplast (Martinoia et al., 2007; Neuhaus, 2007). Some studies have indicated the presence of small vacuoles in addition to the large central one (Schnell Ramos et al., 2011). The plant

cell vacuole has multifaceted roles such as regulation of turgor pressure, cellular energy management, recycling of cell components and cytosolic homeostasis, storage of essential nutrients and reserves and ecological interaction and detoxification (Neuhaus, 2007). It plays a critical role in plant nutrition as a reservoir for essential inorganic nutrients such as K, Ca, Mg, Cl, P, S and N, as well as a range of organic molecules including soluble carbohydrates, amino acids, organic acids, secondary compounds, hydrolytic and biosynthetic enzymes (Blumwald and Gelli, 1997; Martinoia and Ratajczak, 1997; Ratajczak and Wilkins, 2000; Schnell Ramos et al., 2011). The vacuole can store nutrients and release nutrients when required for various needs. Additionally, it has an important role in heavy metal homeostasis and defence responses by accumulating unwanted metals and defence molecules in plant cells (Vögeli-Lange and Wagner, 1990; Clemens, 2001; Schnell Ramos et al., 2011). Various proteins in the tonoplast support the multifaceted functions of vacuoles.

1.1.12 Functioning of the Vacuole

The vacuolar membrane is a very organised membrane functionally, with proton pumps, ion channels and numerous H⁺/X antiporters (Maeshima, 2001). The concentration of substances in the vacuole is generally several fold higher than corresponding concentrations in the cytoplasm, so this accumulation of compounds requires chemical and electrical gradients to be established (Martinoia et al., 2007). Energy is required for this process, and proton pumps help to generate driving forces for uptake by creating a transmembrane H⁺ electrochemical gradient for active transport of solutes (Martinoia et al., 2000).

Ion channels on the vacuolar membrane also use the membrane potential generated by proton pumps. These different transport systems work together to control the vacuole luminal pH, vacuolar volume and the amount of stored materials (Maeshima, 2001). V-type ATPase and a V-PPase are two proton pumps which are responsible for generating and maintaining the ionic gradients that act directly or indirectly as the driving forces for uptake into the vacuole (Rea and Sanders, 1987; Sze et al., 1999; Maeshima, 2001; Kluge et al., 2003). It has been reported that all vacuoles have both types of these pumps (Hedrich and Schroeder, 1989). The main vacuolar transporters are shown in Fig. 1.6.

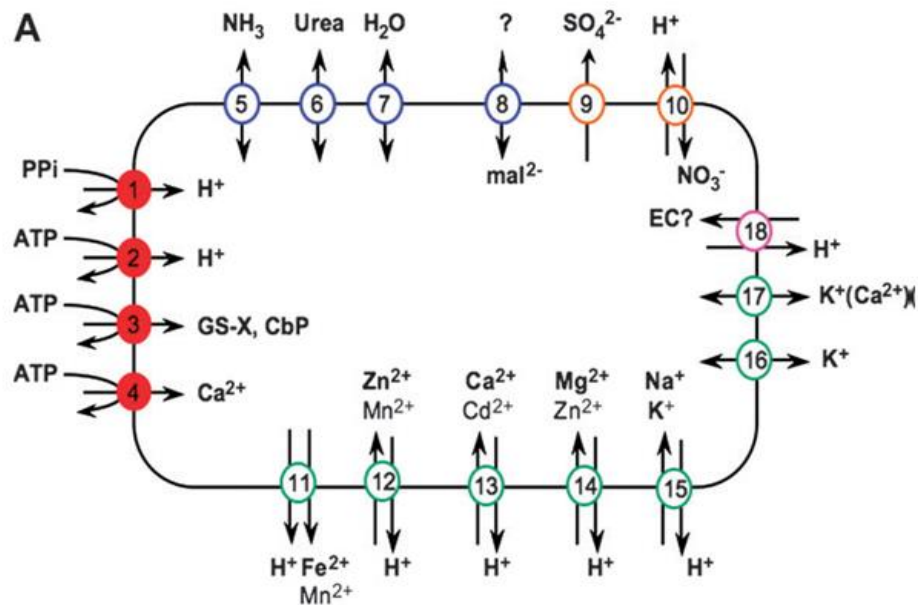

Figure 1.6: Principal ion transporters on the vacuolar membrane:

Red colour: directly energized transporters (1-4)

1, V-PPase; 2, V-ATPase; 3, ABC Transporter; 4, P-type Ca^{2+} pump;

Blue: transporters (tonoplasmic intrinsic protein) for water, ammonia and organic solutes (5-7), malate transporter (8);

Orange: inorganic anion channels and transporters (9-10)

9, sulphate exporter; 10, nitrate proton antiporter;

Green: cation transporters/channels (11-17)

11, iron transporter (NRAMPs); 12, zinc transporter (MTPs); 13, calcium transporter (CAX proteins); 14, magnesium transporter; 15, NHX transporter; 16, TPKI cation channel; 17, SV channel;

Pink: secondary metabolite transporter (EC: Epicatechin transporter) (18)

(from Martinoia et al., 2007)

V-ATPases and V-PPases pump protons from the cytoplasm into the vacuole, generating a pH difference of around 2-3 units and a small electrical potential difference. The membrane potential difference ($\Delta\Psi$) between the cytosol and the vacuolar lumen is found to be low ($\sim 30\text{mV}$) (Martinoia et al., 2007). The V-ATPase and V-PPase generate ΔpH and $\Delta\Psi$, which helps in the transportation of compounds against their

concentration or electrochemical potential gradients (Martinoia et al., 2007). The electrochemical gradient produced by the proton pumps can be utilised to collect cations by a proton antiport mechanism or through ion channels (Martinoia et al., 2000). It has been shown that more than one transporter/channel exists at the vacuolar membrane for the majority of ions (Martinoia et al., 2000).

1.1.13. Vacuolar membrane transporters

Progress in the identification and characterisation of vacuolar transporters has been much slower than that of plasma membrane transporters (Endler et al., 2009), in part due to the difficulties in accessing the vacuole or obtaining extracted tonoplast of high enough purity. However, significant progress has been made in the recent decades, and numerous tonoplast proteins have been identified and characterised as a result of the full sequencing of the Arabidopsis genome (Martinoia et al., 2007; Endler et al., 2009; Martinoia et al., 2012; Sharma et al., 2016; Martinoia 2018; Zhang et al., 2018). A number of vacuolar proteomic investigations have been carried out in Arabidopsis, cauliflower and barley (Endler et al., 2009). These studies have revealed the different roles of tonoplast proteins in various processes including heavy metal homeostasis (Martinoia et al., 2007). According to the direction of transport, these proteins can be broadly classified as importers and exporters (Saurin et al., 1999; Dassa and Bouige, 2001). The broad categories of membrane transporters are illustrated in Fig. 1.7.

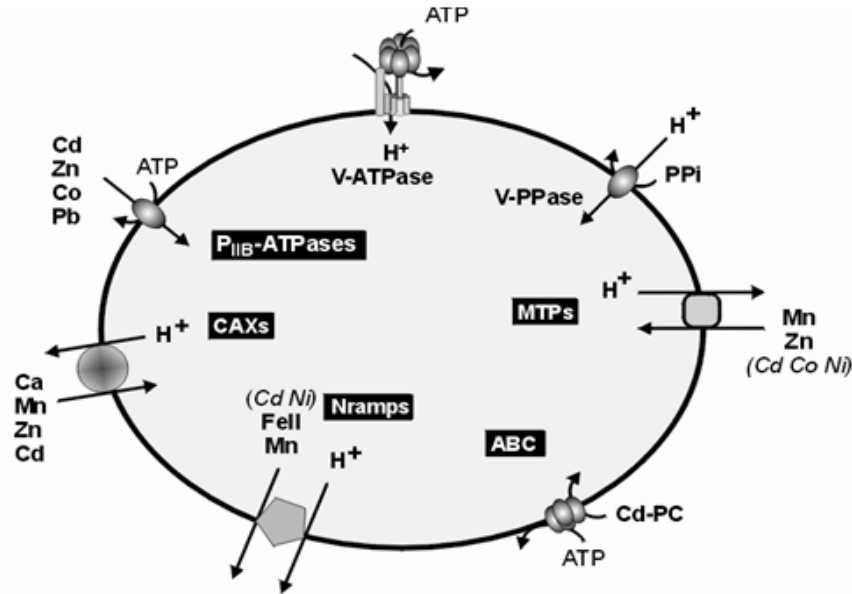

Figure 1.7: Principal membrane transporters involved in the vacuolar sequestration and remobilisation of heavy metal in plant vacuoles: The likely primary substrates are shown in bold and secondary or unintentional substrates in italics (Reid, unpublished).

Transporters such as NRAMP3 and NRAMP4 have been shown to be capable of transport of Cd and Mn in yeast (Thomine et al., 2000; Pittman, 2005). CAX proteins that belong to the Ca/ H^+ cation exchange family are thought to be responsible for the transport of Ca, Mn, Zn and Cd. CAX2 and CAX4 showed high transport activity for Cd in root tonoplast vesicles (Korenkov et al., 2007). Berezin et al. (2008) have shown that MHX is a vacuolar transporter encoded by a single gene in Arabidopsis, which can transport Cd, Mg and Zn. Persans et al. (2001) have provided evidence for the role of MTPs in the transport of Ni, Cd, Co and Zn into vacuoles in *Thlaspi geosingense* (Ni hyperaccumulator).

Salt and Rauser (1995) found evidence for the uptake of Cd-phytochelatin complexes across the tonoplast of oat roots, and the uptake of thiol conjugates into vacuoles was shown by Martinoia et al. (1993), but the transporter responsible was not identified. Several studies suggest that vacuolar-localised ABC Transporters may have an important role in Cd detoxification. These transporters are known to be involved in vacuolar Cd sequestration in yeast (Ortiz et al., 1992; Ortiz et al., 1995). Related ABC transporters, Multidrug Resistant Proteins (MRPs), have been shown to be widely expressed in plant roots in the presence of Cd (Bovet et al., 2003). HMT 1, another ABC

transporter, has been shown to transport GSH/ PC- Cd complexes (Prévéral et al., 2009) or Cd (Sooksa-nguan et al., 2009) in *Schizosaccharomyces pombe*. In addition to HMT 1, ABC2 has also been shown to be involved in vacuolar Cd sequestration (Mendoza-Cózatl et al., 2010). Two ABC transporters, ABCC1 and ABCC2, were implicated in vacuolar PC-As sequestration in *Arabidopsis thaliana* (Song et al., 2010). However, the vacuolar transporters for the sequestration of GS-metal(loid) remain to be discovered (Song et al., 2010). Vacuolar sequestration of PC-Cd was reported in barley (Song et al., 2014) who suggested that an ABC-type transporter may be responsible. In addition to ABCC1 and ABCC2, ABCC3 was also shown to have a role in the transport of PC-Cd to the vacuole in *Arabidopsis thaliana* (Brunetti et al., 2015).

HMA3 (Heavy Metal Associated 3), a member of P_{1B}-ATPase transporter family, is thought to be involved in vacuolar sequestration of Cd, Zn, Co, and Pb in *Arabidopsis thaliana* (Morel et al., 2009). Additionally, various studies provided evidence that OsHMA3 may be a potential candidate for the vacuolar sequestration of Cd in roots as the expression of OsHMA3 in root tonoplast was linked to enhanced Cd tolerance in rice (Ueno et al., 2010; Miyadate et al., 2011; Sasaki et al., 2014). Several other studies reported the potential role of HMA3 in the PC-Cd transport to the vacuole in various Cd hyperaccumulators [*Sedum plumbizincicola*: (Liu et al., 2017); *Sedum alfredii* Hance (Zhang et al., 2016) and *Noccaea caerulescens* (Ueno et al., 2011)].

1.1.14 Partitioning of Cd between vacuole and cytoplasm

Chelation of heavy metals in the cytoplasm by high-affinity ligands and vacuolar sequestration are two main components of plant metal homeostasis, which helps the plants to keep the concentration of essential nutrients within the physiological limits and to minimise the toxic effects of non-essential metals. Therefore, the two possibilities of the localising of heavy metals in a plant cell are either to be retained in the cytoplasm following chelation with peptides and other organic compounds, or to be transported to the vacuole. The exact partitioning of Cd between vacuole and cytoplasm is still a vague area of research. In higher plants, several studies have suggested that Cd accumulates mostly in the vacuoles (Vögeli-Lange and Wagner, 1990; Ramos et al., 2002; Wójcik et al., 2005). In *Agrostis* and maize roots, Cd appeared as electron-dense granules in the cytoplasm, vacuoles and nuclei when exposed to 3 µM Cd (Rauser and Ackerley,

1987). In *Phaseolus vulgaris*, a similar finding was reported in roots when exposed to 0.5 μM Cd (Vázquez et al., 1992). At present, there are no quantitative measurements of the distribution of Cd between cytoplasm and vacuoles.

1.1.15 Root to shoot translocation of Cd

Higher plants have a well-developed vascular system for the transport of water, minerals and products of photosynthesis. Xylem transports water and solutes from roots to shoots whereas phloem transports photosynthates from source (leaves) to sink (roots, seeds and developing young leaves). Within a plant, the distribution of an element can also occur via exchange between xylem and phloem. It is known that Cd is mobile in both xylem and phloem (Reid et al., 2003; Riesen and Feller, 2005; Mendoza-Cózatl et al., 2008; Uraguchi et al., 2009). Additionally, thiol-Cd complexes have been identified in both xylem (Gong et al., 2003) and phloem (Raab et al., 2005; Chen et al., 2006; Mendoza-Cózatl et al., 2008). Therefore, it is likely that thiol complexes have a significant role in the long-distance transport of Cd in plants.

Root to shoot transport of Cd has been studied in many plant species including crop plants. Three key processes that determine how much metal is translocated via the xylem are 1: the extent of sequestration of the metal into the root vacuoles, 2: the symplastic movement of metals across the root and into the stele and 3: the discharge of the metal into the xylem. Several studies from different plants have shown that the capacity for Cd translocation from the roots through xylem is the main factor in shoot Cd accumulation (Hart et al., 2006; Mori et al., 2009; Uraguchi et al., 2009; Li et al., 2017). Wu et al. (2015) showed that transport of Cd from root to shoot is the more influential process than root uptake in determining shoot Cd accumulation, which is supported by several studies showing that grain Cd accumulation is more closely related to the proportion of root Cd that is mobilised, rather than the root Cd content itself (Uraguchi et al., 2009; Ishikawa et al., 2012; Clemens et al., 2013). Various studies suggest that xylem loading of a range of heavy metals is mediated by P_{1B} -type ATPases. In *Arabidopsis thaliana*, the translocation of Zn from root to shoot is regulated by AtHMA2 and AtHMA4 and these transporters also appear to be involved in Cd detoxification (Hussain et al., 2004; Verret et al., 2004; Wong and Cobbett, 2009). In *Arabidopsis halleri*, AhHMA4, a homolog of AtHMA4, was identified for its key role in the transport of Cd and Zn into

shoots (Hanikenne et al., 2008). A couple of studies also demonstrated that OsHMA2 is involved in root to shoot translocation of Cd and Zn in rice (Satoh-Nagasawa et al., 2012; Takahashi et al., 2012).

1.1.16 Involvement of phloem in Cd distribution

Many studies have shown the involvement of phloem as a major pathway for the long-distance transport of Cd from source to sink (Cakmak et al., 2000; Dunbar et al., 2003; Reid et al., 2003; Yada, 2004; Van Belleghem et al., 2007; Mendoza-Cózatl et al., 2008). Kobayashi et al., (2013) provided evidence on the loading of Cd into phloem at the stem soon after Cd was transported from the root, with preferential movement of Cd towards the newest leaf.

The pathways of Cd movement to the developing grain through phloem are possibly either through remobilisation from leaves or directly from xylem to phloem transfer (Tanaka et al., 2007; Yoneyama et al., 2010; Rodda et al., 2011; Clemens et al., 2013). Tanaka et al. (2007) demonstrated that phloem mediates nearly 100% of the Cd deposition into grains. Mendoza-Cózatl et al. (2011) suggested that phloem has a major contribution in the transport of metals to the developing seeds since low transpiration rates in reproductive parts would limit the ability for the xylem to contribute significantly to seed transfer. In some crops like rice, there is the possibility of transport through xylem directly into the grain as xylem is continued into the caryopsis (Zee, 1972; Oparka and Gates, 1984; Krishnan and Dayanandan, 2003), but this would still depend on the transpiration rate in the developing seed or in the glumes (Rodda et al., 2011).

Some studies have suggested that transport into grains through phloem is linked with the involvement of transporters at nodes. OsLCT1 has been identified as a transporter gene involved in the transport of Cd through phloem (Uraguchi et al., 2011), which is expressed highly in nodes and leaf blades during reproductive phases. This is a rice homolog of the wheat Low-affinity Cation Transporter 1 (Clemens et al., 1998), which was the first Cd transporter for phloem identified in plants. Uraguchi and Fujiwara et al. (2012) suggest that the function of OsLCT1 in leaf blades is Cd remobilisation by phloem.

Various studies have demonstrated that Cd is transferred from xylem to phloem at nodes, which is a crucial process for the transport of Cd into the grain. Fujimaki et al.

(2010) showed that the base of the rice stem accumulated the greatest Cd concentration in the shoot and that the Cd concentration then decreased towards the upper parts. The presence of more Cd in the stem node and the discriminatory region at the base of the stem shows their important role in the distribution of Cd (Fujimaki et al., 2010; Ishikawa et al., 2011). In rice Cd is firstly accumulated in the nodes and then distributed preferentially to the developing new leaves and grain, which is similar to the distribution of Zn (Yamaji and Ma, 2014). Yamaji & Ma (2014) outlined various mechanisms for xylem to phloem transfer in nodes, and considered a 'phloem trophic' process involving OsHMA2 by which Cd and Zn follow the same preferential distribution mode at the nodes, could best explain the accumulation of these metals in rice grain.

1.1.17 Exclusion/release of Cd through the phloem

Movement of phloem from shoots to roots is important for transferring photosynthate from the leaves to fuel the functioning of the root. Increased downward transport of Cd from shoot to root has been reported in a low grain Cd-accumulating variety of wheat (Chan and Hale, 2004). In *Arabidopsis thaliana*, the role of phloem in the downward Cd transport to the roots from the leaves has been proposed as a plant strategy to detoxify/release Cd from the shoots (Van Belleghem et al., 2007). Mendoza-Cozatl et al. (2008) suggest that the phloem has a key role in the redistribution of Cd to younger leaves and roots as thiol-Cd complexes. There is also evidence that the Cd is transported to crown root tips from the basal nodes at the vegetative stage in rice plant (Fujimaki et al., 2010). In addition, the release of Cd to the soil through phloem has been reported in wheat (Page et al., 2006).

1.2 Contextual Statement

Heavy metal contamination is a serious concern for human health as the food crops often accumulate heavy metals above the recommended limits in their edible parts. For this reason, reducing heavy metals in the food crops is an urgent need for the better human health. In most cases, reduction in the concentration of toxic metals in soil is impractical, so plant-based strategies to limit heavy metal concentrations in the edible parts of plants need to be considered. However, poor understanding of how heavy metals transported into and out of plant cell is a hindrance for developing strategies aimed at minimising the uptake of toxic metals into the plants or restricting the accumulation in edible parts once they have entered into the roots. Among the heavy metals, Cd is particularly problematic because of its high toxicity and its ability to be accumulated and retained in kidney and bones for decades. Therefore, this study mainly focused on the various factors and mechanisms that affect the transport of Cd in barley. Since Cd is a non-essential metal in plants, the transport characteristics of Cd were compared with those of Ni, an essential micronutrient that occurs in soils at similarly low levels. In agricultural soils, it is rare for heavy metals to be found at concentrations that are toxic to plant growth. However, the majority of transport studies have used much higher concentrations of metals, which may give an unrealistic picture of the uptake characteristics of the metal. The concentrations of Cd and Ni used in the experiments were low and environmentally relevant, all throughout this study. No other studies have integrated the different aspects of the transport of Cd in a plant system including the uptake, translocation, chelation, compartmentalisation and exclusion to the external medium.

1.3 Research Aims and Objectives

The aim of the work presented in this thesis is to study the various factors that affect the uptake, translocation and compartmentalisation of heavy metals, with a focus on Cd, and also the mechanisms that determine the distribution of metals within the plant and its exclusion from the plants.

The research objectives of this thesis are:

1. To analyse the influence of various factors that affect the uptake and transport of Cd and Ni in plants.
2. To investigate the uptake of Cd and Ni directly into cells using isolated shoot protoplasts.
3. To examine the various factors and mechanisms related to the compartmentalisation of Cd into the vacuole including a quantitative assessment of the partitioning of Cd between the vacuole and the cytoplasm in a shoot protoplast.
4. To determine the various mechanisms in the distribution and mobility of Cd within the plant and efflux of Cd from the roots to the external medium.

1.4 Thesis Structure and chapters

There are five experimental chapters.

Chapter 2: Factors affecting the uptake of Cd in barley

Chapter 3: Factors affecting the uptake of Ni barley

Chapter 4: Transport of Cd and Ni into shoot protoplasts

Chapter 5: Cd distribution between cytoplasm and vacuole

Chapter 6: Cd mobility within the plant and efflux of Cd from the roots

Chapter 7: General Discussion

Chapter 2

2. Factors affecting the uptake of cadmium in barley

2.1 Introduction

Crop plants often accumulate heavy metals to concentrations that exceed recommended food standard guidelines. Heavy metal ions such as copper (Cu), zinc (Zn), manganese (Mn), iron (Fe), nickel (Ni) and cobalt (Co) are essential micronutrients for plant metabolism but when present in excess, they can become extremely toxic (Williams et al., 2000). Additionally, non-essential heavy metals like cadmium (Cd), lead (Pb) and mercury (Hg) have no biological functions and are potentially toxic even if taken up at low concentrations, due to their reactivity with S and N atoms in amino acid chains (Clemens, 2001; Schneider et al., 2009). Among these metals, Cd is particularly problematic because of its high toxicity and its ability to be accumulated and retained in kidney and bone for decades (Clemens et al., 2013).

In most cases, reduction in the concentration of Cd in soil is impractical, so plant-based strategies to limit heavy metal concentrations in the edible parts of plants need to be considered. The two main issues are 1, how to minimise uptake into the plant, and 2, how to restrict accumulation in edible parts once Cd has entered the roots. The capacity to manage these two issues is currently inhibited by our poor understanding of how heavy metals that are not needed by the plant are able to cross biological membranes, both into and out of cells. A number of heavy metals are essential for plant growth, and for these, a range of transport proteins has been identified. It is known that some of these transporters have poor selectivity that allows binding and transfer of various other metals (Korshunova et al., 1999; Grotz and Guerinot, 2006). This transport will almost certainly be affected by the relative concentrations of the competing metal species, and it is therefore important to examine this competition at concentrations that would realistically be found in the relevant environment.

In agricultural soils, it is rare for heavy metals to be found at concentrations that are toxic to plant growth, so studies involving high concentrations are likely to give distorted views of the uptake characteristics of the metal. Unfortunately, many of the studies on uptake of Cd fall into this category (Sharma et al., 2004; Bao et al., 2009; Astolfi et al., 2012; Sghayar et al., 2015).

In addition to the relative concentrations of essential and non-essential heavy metals, it is now apparent that the nutrient status of the plant, particularly micronutrient deficiency, can significantly affect uptake. This appears to be mediated by the induction under nutrient deficiency of the synthesis of higher affinity transporters, often with poorer selectivity than those that operate at normal nutrient concentrations. For example, in several species, particularly rice, enhanced Cd uptake has been linked to Fe deficiency (Shao et al., 2007; Rodda and Reid, 2013; Su et al., 2013).

There is considerable variation in accumulation characteristics between different plant species, and even between cultivars of the same species. Most of the work so far has come from studies on rice whose principal method of cultivation (flooded) is quite different to that of the other cereals, and availability of Fe and Cd is strongly linked to the redox status of the soil. Very little is known about the characteristics of Cd uptake in aerobic soils for other cereal crops.

In this chapter, I examined various factors that affect the uptake of Cd in barley. The competition for uptake between Cd and essential micronutrient metals under nutrient-sufficient conditions was investigated to try to identify which transporters are responsible for the leakage of Cd into roots. The competition between Cd and Fe for uptake was also examined by measuring the uptake of $^{55}\text{FeIII}$. I then examined the effects of micronutrient deficiencies on unidirectional influx and net accumulation of Cd in roots to try to understand whether the transporters induced by the deficiencies allowed for increased uptake of Cd.

2.2 Materials and Methods

2.2.1 Solutions

Plants were grown in 0.2 Hoagland's solution. The composition of this solution is shown in Table 2.1. This solution was also used for radiotracer uptake experiments except where modifications are mentioned.

Table 2.1. Composition of 0.2 Hoagland's solution used in this study

Nutrient	Concentration in 0.2 Hoagland's
K	1.2 mM
Ca	1 mM
Mg	0.4 mM
P	0.2 mM
S	0.4 mM
NO ₃	3 mM
FeIII-EDTA	20 µM
B	9.2 µM
Mn	1.8 µM
Zn	0.15 µM
Cu	0.06 µM
Mo	0.02 µM

2.2.2 Plant material

Barley (*Hordeum vulgare* var. Schooner) seeds were germinated on paper towel moistened with deionised water (dH₂O) for three days, then transferred to nutrient solutions and cultured in a controlled environment room on a 14 h/10 h and 26°C/22°C light/dark cycle.

2.2.3 Deficiency treatments for short-term radiotracer experiments

Following germination, seedlings were grown in 3 L tubs containing 0.2 Hoagland' solution for one week. These seedlings were then transferred directly to 4 L pots containing nutrient solutions with different nutrient conditions, based on each experiment. The duration of plant culture in different nutrient conditions was altered

according to the requirements of each treatment. The radio tracer experiments were conducted in 4 L containers (aerated solutions).

2.2.3 Deficiency treatments for net accumulation experiment

The germinated seedlings were grown in 3 L tubs containing 0.2 Hoagland's solution for four days. The seedlings were then rinsed with deionised water to remove surface nutrients, and transferred to 4 L pots (4 seedlings per pot) for a further 24 d, the final 14 d with 1 μM Cd. Solutions lacking Mn or Zn were substituted one week prior to Cd treatment to initiate deficiency (1 week starvation). From trial experiments, Fe deficiency was found to be more rapid, so Fe was only removed from the nutrient solution four days before the beginning of Cd treatment. In these solutions, FeNaEDTA was replaced by daily additions of FeSO_4 to prevent chelation of Cd by EDTA. Nutrient solutions in all four treatments were replaced every second day for two weeks until the day of harvest.

2.2.4 Deficiency treatments for short-term influx experiments

Plants were cultured almost the same as that for the long-term Cd accumulation experiment with a few differences. Firstly, these plants were not exposed to Cd prior to the influx measurements. Secondly, the Zn and Fe deficiencies were initiated later than those in net accumulation experiment to avoid the huge variation in the biomasses between the treatments. Therefore, the plants were more deficient in each treatment than those for the net accumulation experiment before exposing to Cd during the short term influxes (19 days total in Mn deficient treatment 17 days total in Zn deficient treatment and 11 days total in Fe deficient treatment). The radiotracer experiments examined the effects of each micronutrient deficiency separately and also the competitive effect of each on Cd or Ni uptake. Four seedlings from each of the different nutrient conditions (nutrient-sufficient, Mn-deficient, Zn-deficient and Fe-deficient) were placed together in a 20 L container for the 4 hour uptake experiments to provide uniform uptake conditions for all the plants from different nutrient conditions. Due to the short uptake period and the large volume of solutions used for the uptake experiment, it would be unlikely that exudates from the different plants would significantly influence ^{109}Cd uptake.

2.2.5 Radioisotopic tracer influx experiments

For measurement of influx, plants were incubated in aerated solution containing ^{109}Cd or ^{63}Ni or ^{55}Fe for 4 h, then rinsed briefly in RO water to remove the bulk of the surface radioactivity, then desorbed three times for 10 mins in a solution containing 5 mM CaCl_2 , 10 μM CdCl_2 , 0.5 mM citric acid pH 3.5 (desorption solution). Previous studies (R.J. Reid unpublished) showed that this procedure removes approximately 90% of bound Cd following a 4 h uptake period. Following desorption, the roots were cut from the plants, dried in an oven, and then extracted in 10 mM HCl and 1 mM CaCl_2 in a boiling water bath for 30 min. Radioactivity in aliquots of the extracts was determined by liquid scintillation counting (Packard Tri-Carb 2100 TR).

During the influx period, small aliquots of the uptake solution were counted to check for depletion. The concentrations of Cd and Ni were found to remain relatively constant during the uptake period, and no adjustments were needed. However, the concentration of Fe declined, most likely through a combination of root uptake and surface binding in the cell wall, and was therefore adjusted periodically.

2.2.6 Long term Cd accumulation

Plants were cultured as for the short-term radio-tracer influx experiments in 20 L containers except that plants were exposed to 1 μM Cd in the final 2 weeks. At the end of the treatment period, excess apoplastic metals were removed by desorption, as in the radioactive influx experiment. The roots and shoots were separated and blotted with paper towel, weighed then dried at 70°C for three days. The very bottom part of shoot samples was discarded after weighing to avoid any contamination, as these plant parts may have come in contact with the nutrient solution during the plant culture. The roots were digested in strong acid and elemental concentrations were analysed by ICP-OES.

2.2.7 Competition experiments

In the whole root experiments in which competition between Cd and other metals was examined, 5 μM Zn, Mn, FeII, or FeIII were added to the various uptake solutions.

Fell and FeIII solutions were freshly prepared prior to the start of uptake experiments and used immediately for the uptake experiments to prevent/minimise oxidation/reduction.

2.2.8 Statistics

For data analysis, t-test was used to compare mean values from different samples/treatments. The significant differences between different treatments were compared based on the P-value ($p < 0.05$).

2.3. Results

2.3.1 Effect of micronutrient deficiency on the influx of Cd

In this experiment, Cd influx into whole roots was measured. Cd influx was greatly increased by removal of Fell from the uptake solution (Fig. 2.1) and also by combined deficiencies of Mn, Zn and Cu. However, the effect of combined deficiencies of Mn, Zn & Cu on Cd influx was masked by the presence of Fe (Fig. 2.1).

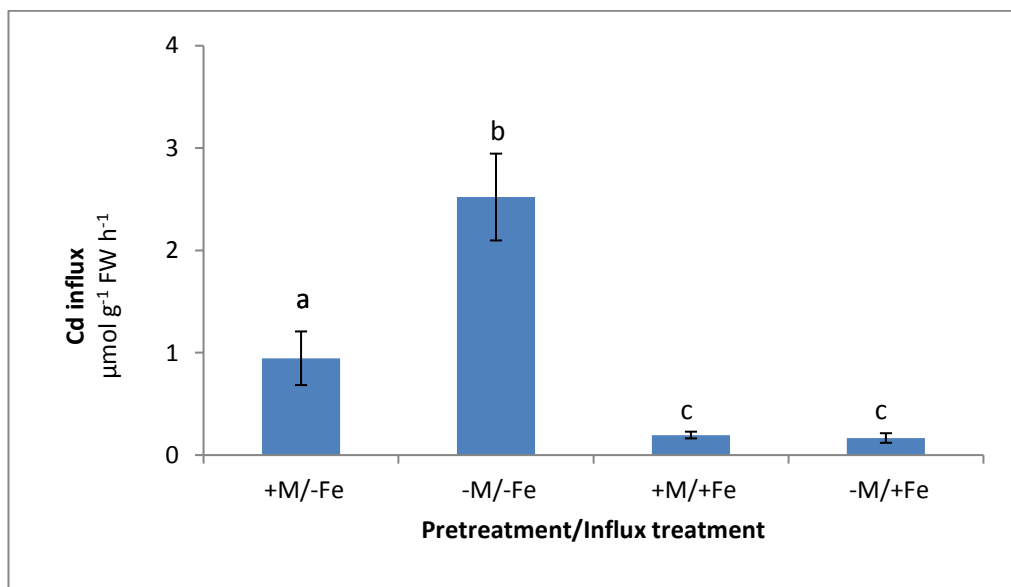

Figure 2.1 Effect of combined micronutrient (Mn, Zn and Cu) deficiency conditions on the uptake of ¹⁰⁹Cd into roots of barley and also the effect of Fell (FeSO₄: 10 µM) on the influx of ¹⁰⁹Cd into roots of both non-deficient (+M) and Mn, Zn and Cu starved (-M)

plants (two weeks in deficient medium), with a concentration of 1 μM Cd in the uptake solution. Influx time = 4 h, followed by 0.5 h desorption. The results show the mean \pm s.e. of 4 replicates. Different letters above columns designate means that are significantly different ($P < 0.05$).

2.3.2 Effect of Fe nutrition on the uptake of Cd and the competition between Cd and Fell

In the experiment shown in Fig. 2.1, all plants were Fe-sufficient and Fe was either absent or present in the influx solution. In this next experiment, the influence of Fe nutrition status was examined. Fe starvation increased Cd influx more than 9-fold when Fe was also absent from the influx solution and nearly 8-fold when Fe was present in the influx solution (Fig. 2.2).

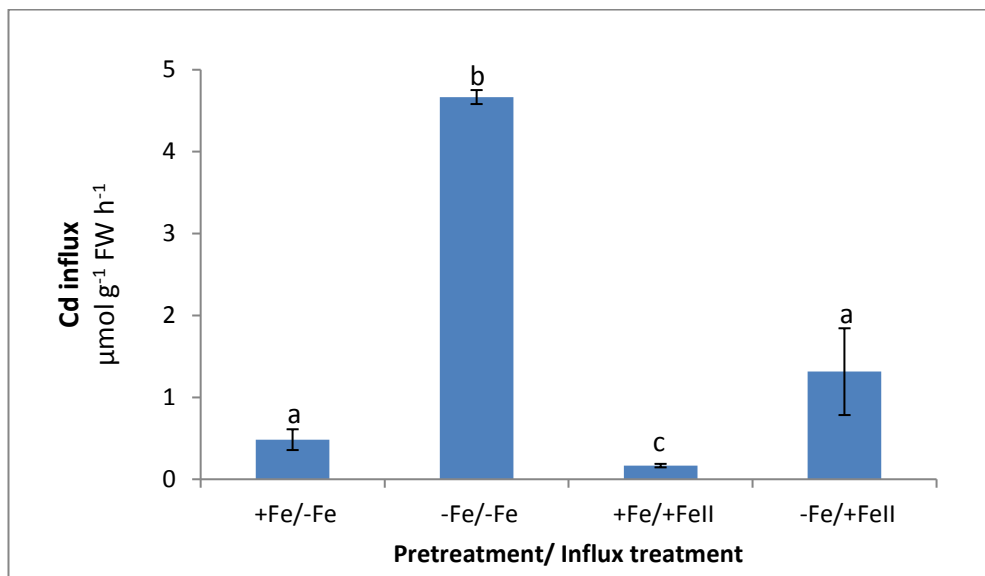

Figure 2.2 Effect of Fe nutrition and the effect of Fell (FeSO_4 : 10 μM) on the influx of ^{109}Cd into roots of both Fe-sufficient (+Fe) and Fe-starved (-Fe) plants (two weeks in deficient medium), with a concentration of 1 μM Cd in the uptake solution. Influx time = 4 h, followed by 0.5 h desorption. The results show the mean \pm s.e. of 4 replicates. Different letters above columns designate means that are significantly different ($P < 0.05$).

2.3.3. Effect of mild Fe deficiency on the uptake of Cd and the competition between Cd and FeIII

The previous experiment examined the effects of Fe nutrition on Cd influx, and the presence or absence of FeII in the influx solution. A similar experiment was conducted but with FeIII replacing FeII during the influx period. Again there was a significant but lesser increase in Cd influx in Fe-deficient plants but the effect of FeIII on influx (Fig. 2.3) was much less than that of FeII (Fig. 2.2). In Fe-sufficient plants, FeIII in the influx solution had no significant effect on Cd influx (Fig. 2.3). In this experiment, plant growth in the deficient medium was reduced to one week to observe any effects on influx during the onset of deficiency. Despite the short period of Fe withdrawal, Fe deficiency resulted in large stimulations of Cd influx.

Cd is known to form complexes with Cl, and in these experiments Fe was added as the Cl salt. However, at the concentrations used (μM), geochemical speciation modelling (GEOCHEM-PC) showed that the level of chloro complexes would be very low.

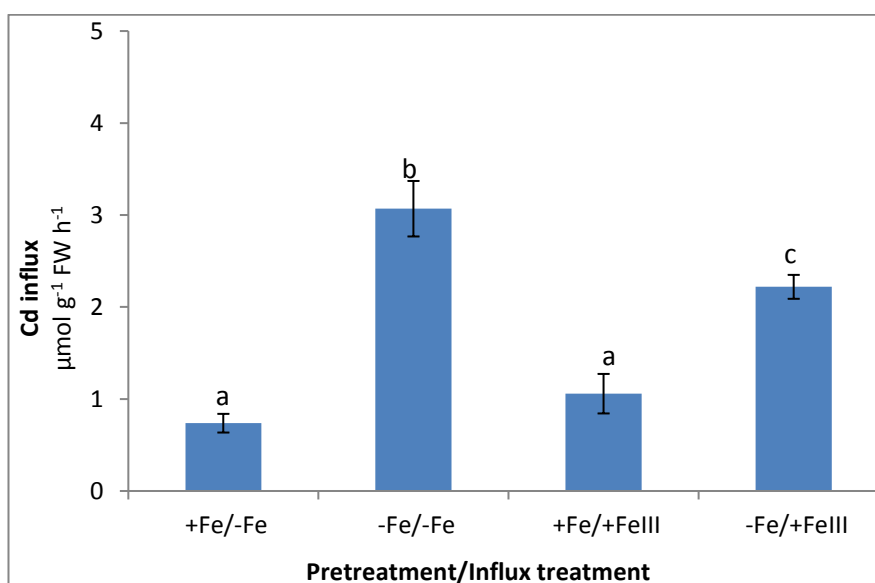

Figure 2.3 Effect of mild Fe deficiency on the uptake of ^{109}Cd into roots of barley and also the effect of FeIII (FeCl_3 : $10 \mu\text{M}$) on the influx of ^{109}Cd into roots of both Fe-sufficient (+Fe) and Fe-starved (-Fe) plants (only one week in the deficient conditions), with a concentration of $1 \mu\text{M}$ Cd in the uptake solution. Influx time = 4 h, followed by 0.5 h

desorption. The results show the mean \pm s.e. of 4 replicates. Different letters above columns designate means that are significantly different ($P < 0.05$).

2.3.4 Effect of Cd on the influx of $^{55}\text{FeIII}$

The competition between Cd and Fe for uptake was further examined by measuring the uptake of $^{55}\text{FeIII}$. The removal of Cd from the uptake solution increased Fe uptake in Fe-starved plants but in Fe-sufficient plants influx was unaffected by the presence or absence of Cd (Fig. 2.4).

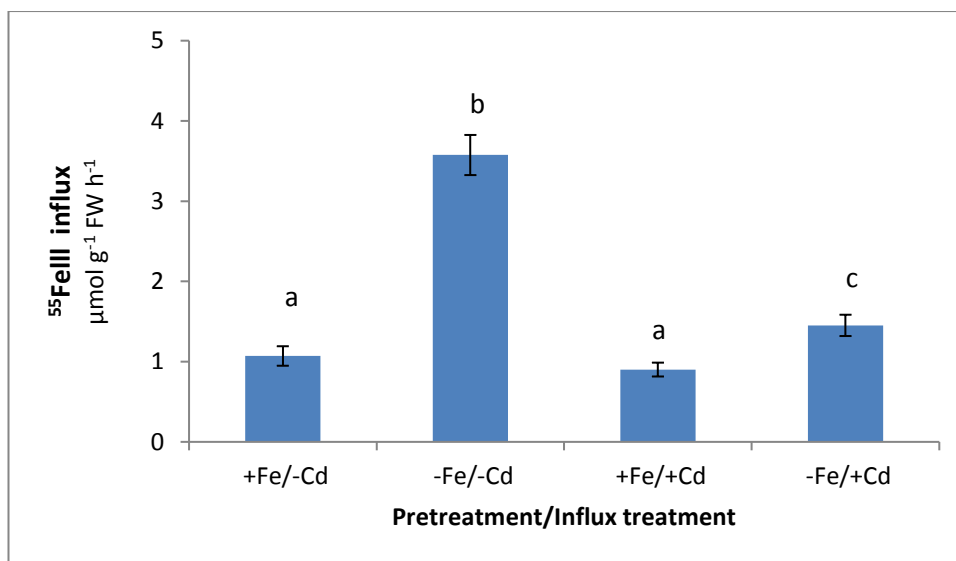

Figure 2.4 Effect of Cd ($1 \mu\text{M}$) on the uptake of $^{55}\text{FeIII}$ ($10 \mu\text{M}$) into roots of both Fe-sufficient (+Fe) and Fe-starved (-Fe) barley plants. Influx time = 4 h, followed by 0.5 h desorption. The results show the mean \pm s.e. of 4 replicates. Different letters above columns designate means that are significantly different ($P < 0.05$).

2.3.5 Effect of micronutrients on the influx of ^{55}Fe

Addition of the micronutrient metals Mn, Zn and Cu to the uptake medium of Fe-sufficient and Fe-deficient plants had no significant impact on the uptake of $^{55}\text{FeIII}$ (Fig. 2.5), consistent with the results shown in Fig 2.4. The only notable variation was a stimulation of FeIII influx in Fe-deficient plants.

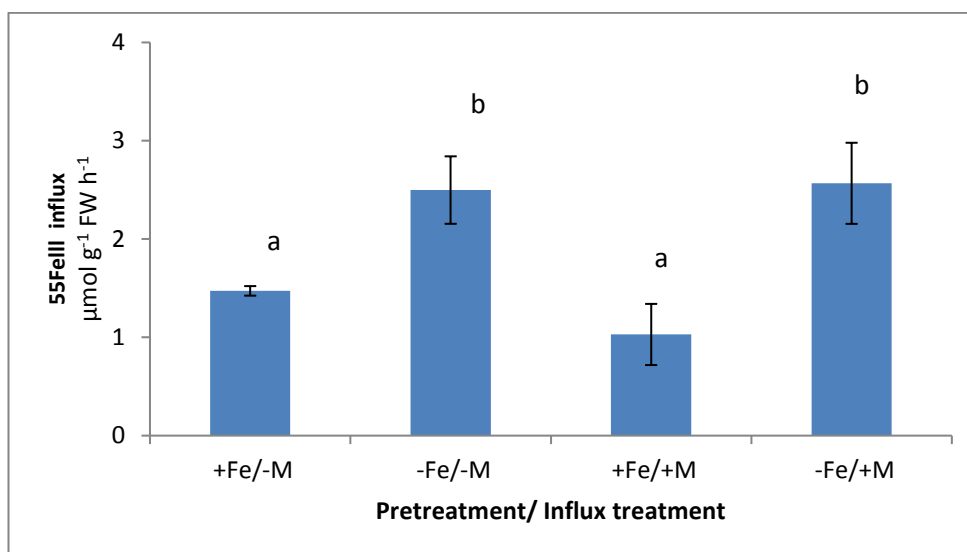

Figure 2.5 Effect of micronutrients on the uptake of $^{55}\text{FeIII}$ into roots of both Fe-sufficient (+Fe) and Fe-starved (-Fe) plants. Influx time = 4 h, followed by 0.5 h desorption. The results show the mean \pm s.e. of 4 replicates. Different letters above columns designate means that are significantly different ($P < 0.05$).

2.3.6 Effect of the presence of micronutrients and micronutrient deficiency on the influx of $^{55}\text{FeIII}$

FeIII influx was stimulated 2.6-fold by combined micronutrient (Mn, Zn, Cu) starvation (Fig. 2.6). There was a similar stimulation in non-starved plants when competing micronutrients were removed from the influx solution. However, in micronutrient-starved plants, FeIII influx was not affected by the presence or absence of micronutrients in the influx solution (Fig. 2.6).

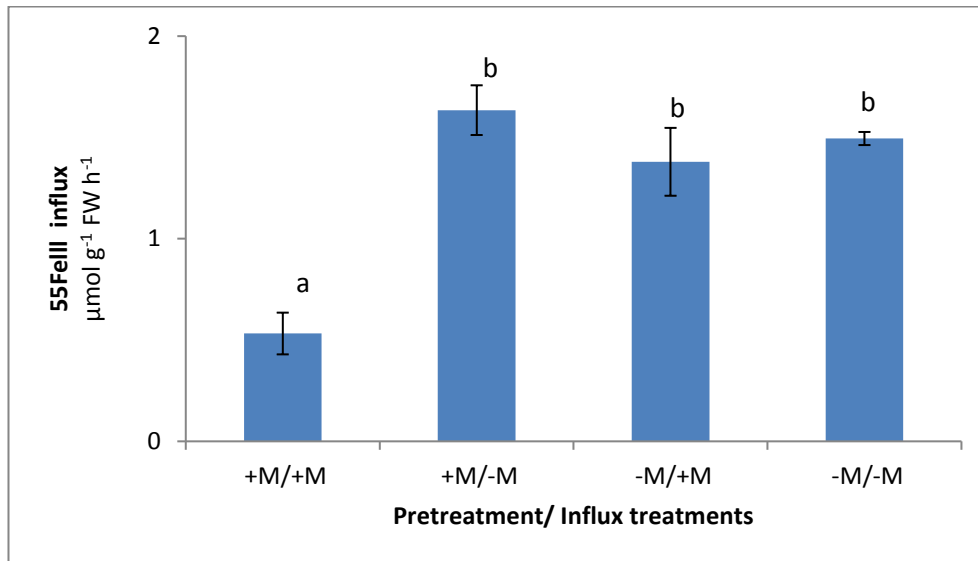

Figure 2.6: Effect of combined micronutrient deficiency (-Mn, -Zn,-Cu) on the influx of ⁵⁵FeIII into roots of barley and also the effect of micronutrients (+Mn+Cu+Zn) in the uptake medium on the influx of ⁵⁵FeIII (10 μM) into roots of both non-deficient (+M) and Mn, Zn and Cu starved (-M) plants. Influx time = 4 h, followed by 0.5 h desorption. The results show the mean ± s.e. of 4 replicates. Different letters above columns designate means that are significantly different (P<0.05).

2.3.7. Cd influx into whole roots under different nutrient conditions

The experiments above have shown that micronutrient status of barley plants can have a large impact on influx of Cd. With the exception of Fe deficiency, the experiments involved the simultaneous removal of Mn, Zn, and Cu. Based on competitive interactions revealed by in vitro gene expression studies, the most likely micronutrients to affect Cd uptake apart from Fe were Mn and Zn. A series of experiments was therefore conducted to investigate the effects of deficiencies of each micronutrient separately, and the competitive effect of each on Cd uptake. Although already previously investigated, Fe deficiency was also included for comparison.

The micronutrient status of the plants was altered by growing them in solutions deficient in either Mn, Zn or Fe. The influx solution only contained macronutrients; micronutrients were omitted to try to reveal the effects of different deficiencies on Cd influx, in the absence of competitive interactions with other micronutrient metals. Influx of ¹⁰⁹Cd over 4 hours was 2.6-fold higher in roots of plants

deficient in Zn, but unaffected by Mn-deficiency (Fig. 2.7). The effect of Zn deficiency was even greater than that resulting from Fe deficiency.

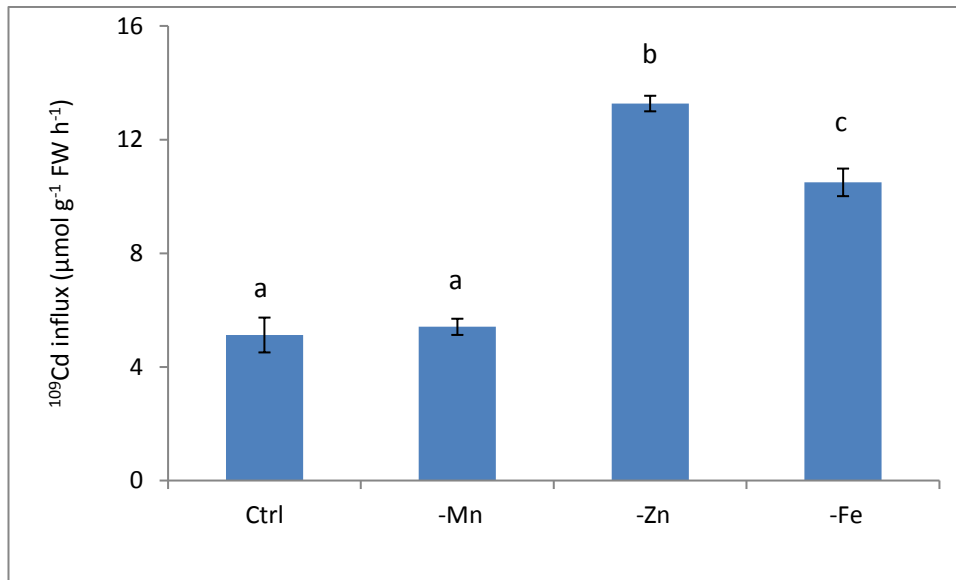

Figure 2.7 Effect of different deficiency conditions on the uptake of ^{109}Cd into roots of barley. For each of the different nutrient conditions, plants were cultured in the respective treatment (full nutrient, Mn-deficient, Zn deficient and Fe deficient conditions). Influx time = 4 h, followed by 0.5 h desorption. The results show the mean \pm s.e. of 4 replicates. Different letters above columns designate means that are significantly different ($P < 0.05$).

2.3.8. Competition between Cd and micronutrient metals

The effect of increasing the concentration of potential competing cations on Cd influx was examined by adding elevated concentrations of Mn, Zn, FeII and FeIII (all 5 μM). Higher concentrations of FeII and Zn inhibited influx into roots, but supplemental Mn had no effect (Fig 2.8).

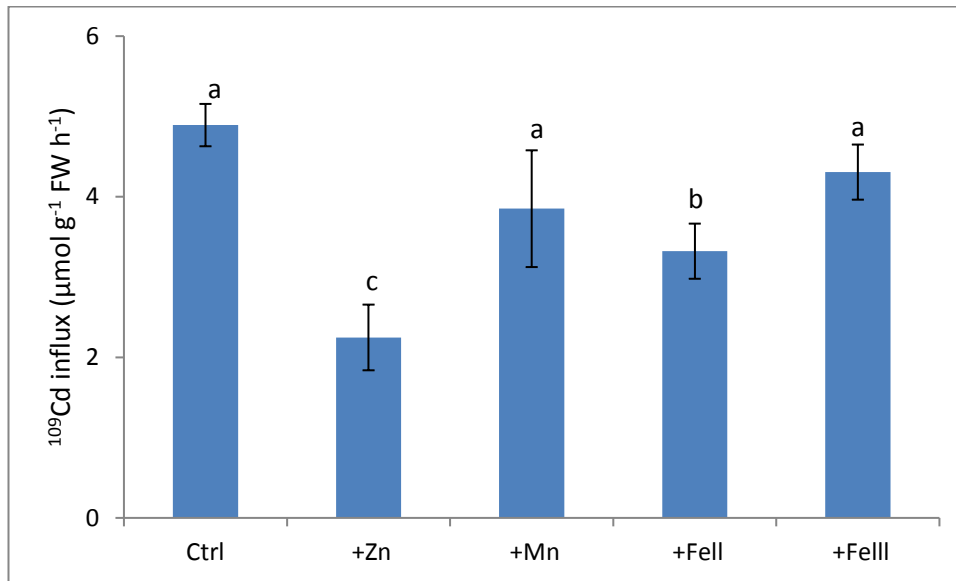

Figure 2.8 Effect on the influx of ^{109}Cd into roots of the addition of higher micronutrient concentrations (FeSO_4 : 5 μM , FeCl_3 : 5 μM , MnCl_2 : 5 μM , and ZnSO_4 : 5 μM) in the nutrient solutions, with a concentration of 1 μM Cd in the uptake solution. Uptake time = 4 hours. Values are the mean \pm s.e. ($n=4$). Different letters above columns designate means which are significantly different.

2.3.9. Effect of deficiencies on long-term accumulation of Cd

Long-term accumulation of Cd was measured by elemental analysis of root and shoot material after four weeks growth, the latter two weeks in the presence of 1 μM Cd. For each of these studies, the micronutrient status of the plants was altered by growing them in solutions deficient in either Mn, Zn or Fe.

Each of the deficiency treatments caused the root concentrations of the deficient element to decline by at least 50% (Table 2.1). The effects on growth were found to be more variable (Fig. 2.11). No difference in growth was observed under Mn deficiency despite the much lower root Mn concentration. Zn deficiency caused a moderate reduction in growth, while Fe deficiency reduced growth by approximately 60% (Fig. 2.11). Roots and shoots were equally affected with little change in the root: shoot ratios.

Table 2.2. Concentrations of Fe, Mn, Zn and Cd in roots and shoots of barley grown under nutrient-deficient conditions. Values are means \pm s.e (n=4). Values in bold type are significantly different from the control values (P<0.05). Translocation factor is the ratio of shoot: root concentrations.

	Root elemental concentration (mg/kg DW)			
Deficiency	Fe	Mn	Zn	Cd
None	8425 \pm 357	152 \pm 3	75 \pm 9	444 \pm 6
-Fe	54 \pm 1	220 \pm 7	57 \pm 5	1125 \pm 27
-Mn	8675 \pm 232	53 \pm 2	54 \pm 5	425 \pm 12
-Zn	10200 \pm 471	96 \pm 3	39 \pm 2	528 \pm 8
	Shoot elemental concentration (mg/kg DW)			
None	98 \pm 8	63 \pm 5	36 \pm 2	28 \pm 2
-Fe	30 \pm 1	455 \pm 7	173 \pm 13	83 \pm 2
-Mn	121 \pm 4	50 \pm 2	52 \pm 9	30 \pm 1
-Zn	403 \pm 10	117 \pm 2	19 \pm 3	42 \pm 1
	Translocation Factor			
None	0.012 \pm 0.001	0.414 \pm 0.036	0.495 \pm 0.054	0.063 \pm 0.003
-Fe	0.556 \pm 0.018	2.075 \pm 0.109	3.155 \pm 0.575	0.074 \pm 0.002
-Mn	0.014 \pm 0.001	0.959 \pm 0.097	0.949 \pm 0.152	0.071 \pm 0.003
-Zn	0.040 \pm 0.002	1.217 \pm 0.033	0.480 \pm 0.041	0.080 \pm 0.003

Deficiency in Fe increased the concentration of Cd in roots 2.5-fold and in shoots 3-fold (Table 2.2). The concentration of Mn also increased under Fe deficiency, especially in shoots where a 7-fold increase was observed (Table 2.1). Cd concentrations were unaffected by Mn deficiency in both roots and shoots and slightly elevated under Zn deficiency. However, although nutrient deficiencies may have altered tissue Cd concentrations, they did not affect the total amounts of Cd in the plants (Fig. 2.12). Remarkably, the percentage of Cd in shoots was virtually constant at $10 \pm 1\%$ across all

treatments. Effectively, the increase in tissue Cd concentration induced by the deficiencies was offset by the lower biomasses.

Translocation factors for Cd showed only minor deviations across the deficiency treatments, indicating that changes in concentrations in shoots reflected changes in root concentrations (Table 1).

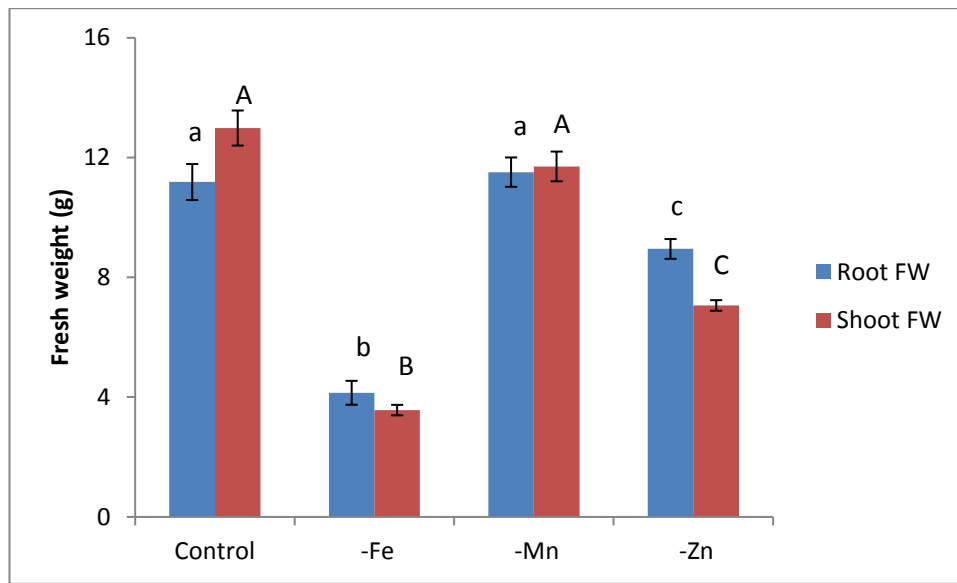

Figure 2.11 Root and shoot fresh weight for barley cultured in full nutrient, Mn-deficient, Zn-deficient or Fe-deficient conditions. Plants were grown for 4 weeks, the final 2 weeks with 1 μ M Cd. Mean values are shown \pm s.e. (n=4). Statistical analysis was done separately for roots and shoots. Roots were compared with roots (blue bars), and shoots were compared with shoots (red bars). Significant differences between samples are designated by different letters ($P < 0.05$), lower case letters for roots and capital letters for shoots.

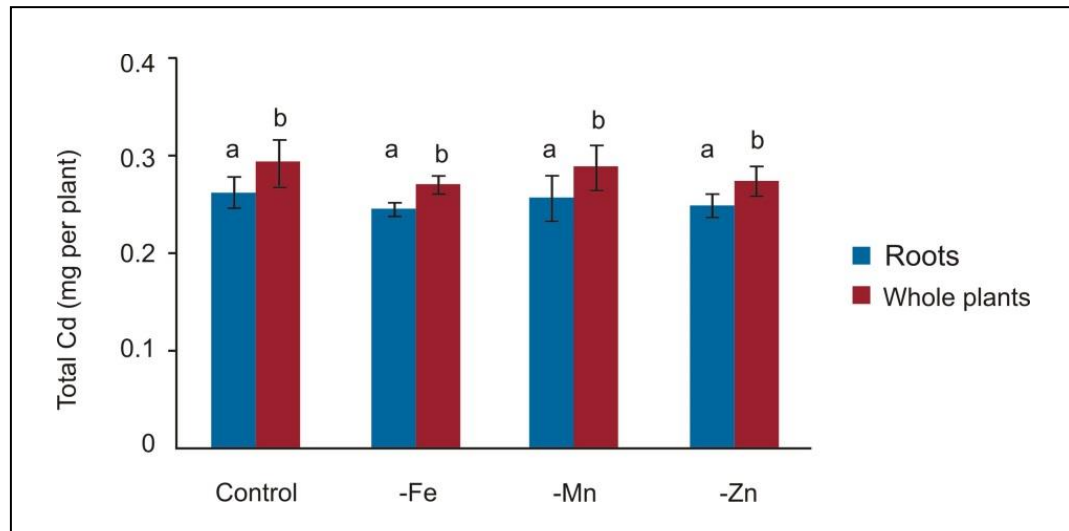

Figure 2.12 Total Cd in roots and whole plants of barley grown under different nutrient deficiency conditions. Statistical analysis was completed separately for roots and whole plants. Roots were compared with roots (blue bars), and whole plants were compared with whole plants (red bars). Significant differences between samples are designated by different letters ($P < 0.05$).

2.4 Discussion

Addition of $1 \mu\text{M}$ Cd to the growth medium resulted in quite high concentrations of Cd in both roots and shoots (Table 2.2), indicating that pathways must be present for the easy penetration into roots and subsequent redistribution of Cd within the plant. The results of these experiments have demonstrated that the uptake of Cd can be greatly influenced by other micronutrient cations, both via nutrient deficiencies and by the competition for uptake. Results obtained in the short term influx experiments demonstrate that Fe (Fig. 2.2, Fig 2.3) and combined micronutrient (Mn, Zn and Cu) deficiencies (Fig.2.1) have a major impact on Cd uptake. Another follow-up short radiotracer experiment was done to illustrate the specific effect of each micronutrient (Fe, Mn and Zn) on the uptake of Cd.

Both long term accumulation and short term radiotracer experiments provided evidence that Fe and Zn have major effects on Cd uptake. The effect of Zn on Cd uptake

was observed in treatments in which the plant Zn status or the concentration of Zn in the uptake medium were manipulated. In both long-term accumulation (Table 2.2) and short-term influx experiments (Fig. 2.7), the absence of Zn stimulated uptake of Cd. Based on the results from short-term influxes, there appear to be two separate interactions between Cd and Zn, one related to the increased capacity for Zn uptake induced by Zn deficiency (Fig. 2.7), and the other to competition between Zn and Cd for uptake (Fig. 2.8). It is important to note that the Cd influxes showed in Fig 2.7 were measured in the absence of competing micronutrient ions, so as to make it possible to distinguish between the effect of deficiency *per se* on Cd transport, from the competition between cations for uptake. Hence, it can be concluded that the 2.5-fold stimulation of Cd influx (Fig. 2.7) is directly related to the lower internal Zn concentration in Zn-deficient plants. On the other hand, the results in Fig. 2.8 show that when Zn is added to the uptake medium for Zn-sufficient plants, Cd influx is inhibited. The values for Cd influx were 13.3, 5.3 and 2.2 $\mu\text{mol g}^{-1}\text{h}^{-1}$ for Zn-deficient (no Zn in uptake solution), Zn-sufficient (no Zn in uptake solution) and Zn-sufficient (Zn in uptake solution) respectively. This result is consistent with the reduction in accumulation of Cd in lupin following soil supplementation of Zn (Brennan and Bolland, 2014). Interestingly, the increase in Cd uptake by Zn deficiency was relatively small in the long-term accumulation experiment (Table 2.2) when compared to the huge increase of Cd influx when measured over 4 h (Fig. 2.7). A likely explanation for this is that in the long term experiment, competing micronutrient cations that can suppress the Cd uptake were present in the culture medium, but were absent in the influx measurements. Results obtained in the long term experiment demonstrated that Zn-deficient plants have a much higher Fe concentration in roots when compared to the Zn-sufficient plants (Table 2.2). Fe was shown to strongly inhibit Cd influx (Fig. 2.8 & Fig. 2.2), which may lower the long term uptake of Cd in Zn deficient plants. Altogether, these results suggest that Zn transporters have a significant role in the uptake of Cd.

The long term effect of Fe on Cd uptake (Table 2.2) was similar to the short term influxes (Fig 2.7, Fig. 2.2 & Fig. 2.3). The results showed that Fe-starved plants took up much more Cd. In addition, removal of Fe from the uptake solution greatly increased Cd uptake (Fig. 2.2), and the removal of Cd from the uptake solution increased Fe uptake, but only in Fe-starved plants (Fig.2.4). These results also strongly suggest that the main

route for Cd uptake is via Fe transporters that are induced by Fe deficiency. In the competition experiments (Fig. 2.2, Fig. 2.3 & Fig. 2.8), Cd influx was unaffected by FeIII but was inhibited by FeII, which would seem to indicate that Cd uptake into the root occurs through divalent cation transporters rather than being mediated by phytosiderophores.

Other studies have demonstrated an increase in Cd uptake in Fe-deficient plants [e.g. barley: (Sharma et al., 2004); rice: (Nakanishi et al., 2006); peanut: (Su et al., 2013)]. Various studies on rice using mutants have implicated Fe transporters (OsNRAMP1 and OsNRAMP5) in Cd uptake (Takahashi et al., 2011; Ishimaru et al., 2012) while others found interactions between Cd and Zn transport (Sato-Nagasawa et al., 2012; Takahashi et al., 2012). Uptake of Cd via these transporters is almost certainly by competition between metals for binding to the transporter. There are two important elements to this: the relative affinity for the different metals, and their respective concentrations. Experiments using high concentrations of Cd are unlikely to predict Cd fluxes at concentrations applicable to even highly contaminated agricultural soils, which are at least an order of magnitude lower than the Cd concentration at which toxicity to plant growth is observed. Comparison between soil solution Cd concentrations and those in nutrient solutions is complicated by the myriad of factors that determine availability in different soils. The concentration of Cd used in the current experiments, 1 μM , is likely to be at the higher end of the agricultural spectrum (Sauvé et al., 2000) but still below the concentration at which plant growth is affected. At lower Cd concentrations, the competitive effects of other trace metals are expected to be even greater than shown here. It is known that the expression of FeII transporter, IRT1, is strongly up-regulated as a result of Fe deficiency (Nakanishi et al., 2006; Takahashi et al., 2011; Ishimaru et al., 2012). ZIP1, a Zinc transporter, has been shown to transport Cd also in rice (Ramesh et al., 2003). Based on current results, the most likely candidates for the transport of Cd across plasma membrane would be IRT1, NRAMPs and ZIP1

The results showed neither the plant Mn status nor the presence or absence of Mn in the uptake solution affected Cd uptake into the plants. The effect of Mn deficiency on Cd influx measured in the short-term tracer experiments was found to be consistent with the longer term accumulation experiment. This finding is in line with the

result in Fig. 2.8 which showed that Cd influx was unaffected when Mn was added to the uptake medium for Mn-sufficient plants.

Both Fe and Zn deficiencies increased net shoot accumulation of Cd, but huge increase in the case of Fe may simply be the consequence of a comparable increase in root Cd under these conditions (Table 2.2,). Bao et al. (2009) have shown that Fe deficiency increases Cd translocation efficiency. In contrast, another study reported that Fe deficiency inhibits Cd translocation in peanut (Su et al., 2013). However, our results support that Fe deficiency increases Cd translocation to the shoot. A more curious result was the 4-fold increase in shoot Fe concentration in Zn-deficient plants (Table 2.2); we can only speculate that this may be related to competition between Fe and Zn for loading into the xylem.

The results point to two strategies for reducing the uptake of Cd into barley plants. The strong effect of Fe and Zn deficiency on Cd uptake shows that proper Fe and Zn nutrition is very important for reducing Cd uptake into the plant. Cd uptake also appears to depend on the ratio of Cd: Zn and Cd: Fe in the soil solution, so supplementation with Zn and Fe above the level required for normal nutrition is likely to inhibit Cd uptake.

The barley cultivar used throughout this study was Schooner. Oliver et al. (1996) suggested that Schooner was likely to be a medium to high Cd accumulator in relation to other barley cultivars. Since the accumulation characteristics of Cd vary between cultivars, the Cd accumulation seen in this study may not be the same with other cultivars. Further work is required to establish the transport characteristics of Cd with a wider range of cultivars of barley.

Chapter 3

3. Factors affecting the uptake of nickel into barley

3.1 Introduction

Unlike Cd, Ni is an essential micronutrient for plant growth. Brown et al (1987) identified Ni as an essential micronutrient for all higher plants. It was originally shown to be a key part of the active site of the enzyme urease, which is responsible for breaking down urea in plants (Eskew et al., 1983). However, more recently it has been implicated in reducing oxidative stress through activation of glyoxalase I which breaks down methylglyoxal, a toxic compound that is formed naturally in small amounts during glycolysis and photosynthesis (Fabiano et al., 2015). However, plants require only a trace amount of Ni and excess can be toxic to plants. The Ni content in soil may vary, normally ranging from 0.2 mg kg⁻¹ to 450 mg kg⁻¹ (Ahmad and Ashraf, 2012). Except in cases of anthropogenic pollution, the higher concentrations are usually associated in serpentine soils, and plants growing on these soils are often Ni hyperaccumulators (Goolsby and Mason, 2015).

As discussed in the previous chapter, various transporters with poor selectivity are involved in the uptake and transport of essential metals including Ni. Since Ni is essential for plant growth, it is reasonable to speculate that specific Ni transporters are likely to be involved in the transport processes. However, physiological mechanisms underlying Ni transport in plants are far from being fully understood. A recent survey of Ni contents of food crops has highlighted the importance of plant physiological studies on the uptake and distribution of Ni (Luo et al., 2017).

As with Cd, Ni transport will almost certainly be affected by the relative concentrations of competing metal species, and it is therefore important to examine this competition at concentrations that would realistically be found in the normal agricultural soil. In most cases, agricultural soils contain only minute quantities of Ni, and as such; it will not normally cause any toxicity to plant growth. However, most of the studies on uptake of Ni have used a much higher concentration of Ni (Schaaf et al., 2006; Nishida et al., 2011; Nishida et al., 2015), which give unrealistic pictures of the uptake characteristics of the metal. As discussed in the previous chapter, the nutrient

status of the plant, mainly micronutrient deficiency, can also significantly affect the uptake characteristics of trace metals. A recent survey showed that rice, legumes and root crops contain the highest Ni concentration (Luo et al., 2017) but there is little information on the accumulation of Ni in cereal crops like barley.

In this chapter, I examined various factors that affect the uptake and internal distribution of Ni in barley, and compared the results with those obtained for Cd. The competition between Ni and essential micronutrients was investigated to try to identify which transporters are responsible for the uptake of Ni into roots. I then examined the effects of micronutrient deficiencies on unidirectional influx and net accumulation of Ni in roots to try to understand whether the transporters induced by the deficiencies allowed for increased uptake of Ni.

3.2 Materials and Methods

The methodologies for all the experiments were similar to the methodology in Chapter 2, but Cd was replaced with Ni.

3.3 Results

3.3.1 Effect of Fe nutrition on influx of Ni and the competition between Ni and FeII

Ni influx was influenced both by the Fe nutrition status of the plants and by the presence or absence of Fe in the influx medium. There was a strong effect of Fe starvation which stimulated Ni influx, more so when FeII was also absent from the influx solution. Inclusion of FeII in the influx solution resulted in large reductions in Ni influx in both Fe-deficient and Fe-sufficient plants (Fig. 3.1).

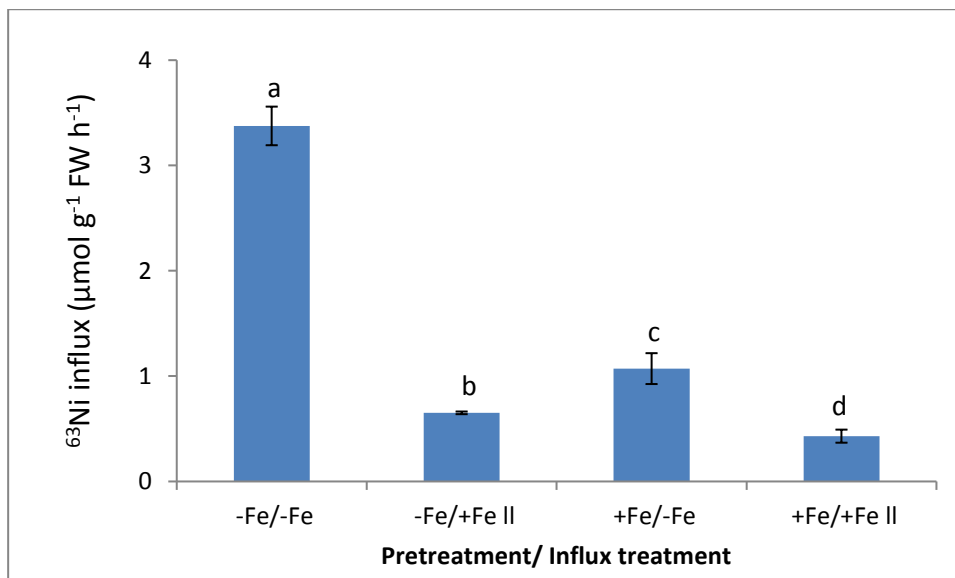

Fig 3.1: Effect of Fe nutrition and the effect of FeII (FeSO_4 : 10 μM) on the influx of ^{63}Ni into roots of both Fe-sufficient (+Fe) and Fe-starved (-Fe) plants (two and a half weeks in deficient medium), with a concentration of 1 μM Ni in the uptake solution. Influx time = 4 h, followed by 0.5 h desorption. The results show the mean \pm s.e. of 4 replicates. Different letters above columns designate means that are significantly different ($P < 0.05$).

3.3.2. Effect Fe deficiency on influx of Ni and the competition between Ni and FeIII

In this experiment, the effect of the presence or absence in the influx solution of FeIII rather than FeII was examined. For this experiment the starvation time was reduced to 1 week but the large stimulation of Ni influx in the Fe-deficient plant remained the same. However unlike FeII, Fe III had no significant effect on Ni influx in Fe-deficient plants, and only a small effect in Fe-sufficient plants (Fig. 3.5).

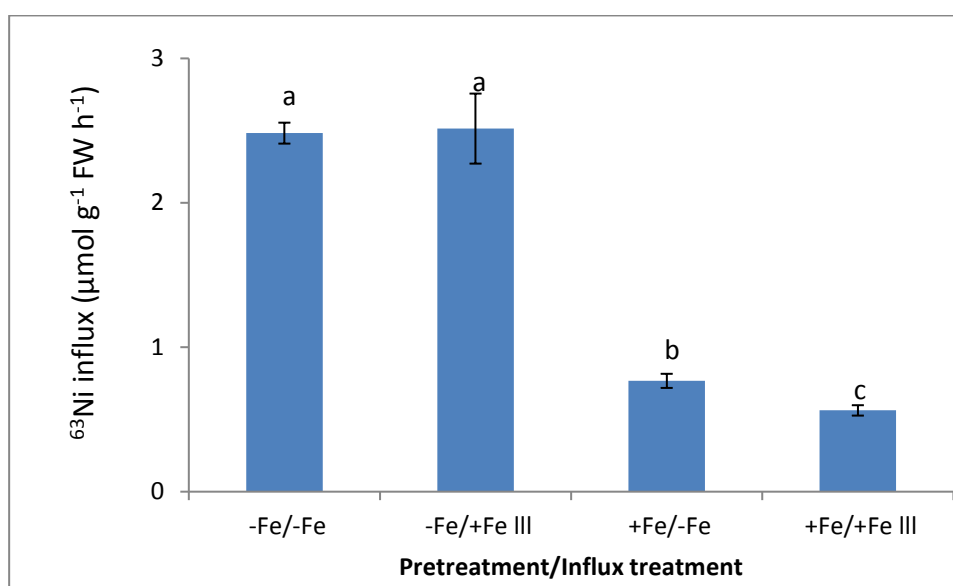

Figure 3.2 Effect of Fe deficiency on the uptake of ⁶³Ni into roots of barley and also the effect of FeIII (FeCl₃: 10 µM) on the influx of ⁶³Ni into roots of both Fe-sufficient (+Fe) and Fe-starved (-Fe) plants (only one week in the deficient conditions), with a concentration of 1 µM Ni in the uptake solution. Influx time = 4 h, followed by 0.5 h desorption. The results show the mean ± s.e. of 4 replicates. Different letters above columns designate means that are significantly different (P<0.05).

3.3.3. Competition between Ni and micronutrient metals

In this experiment, plants grown under full nutrient conditions were used to examine the effect of increasing the concentration of potential competing cations on Ni influx. FeIII, FeII, Zn and Mn all inhibited Ni influx into roots by more than 50%, with FeIII being less inhibitory than FeII, Zn and Mn (Fig 3.3).

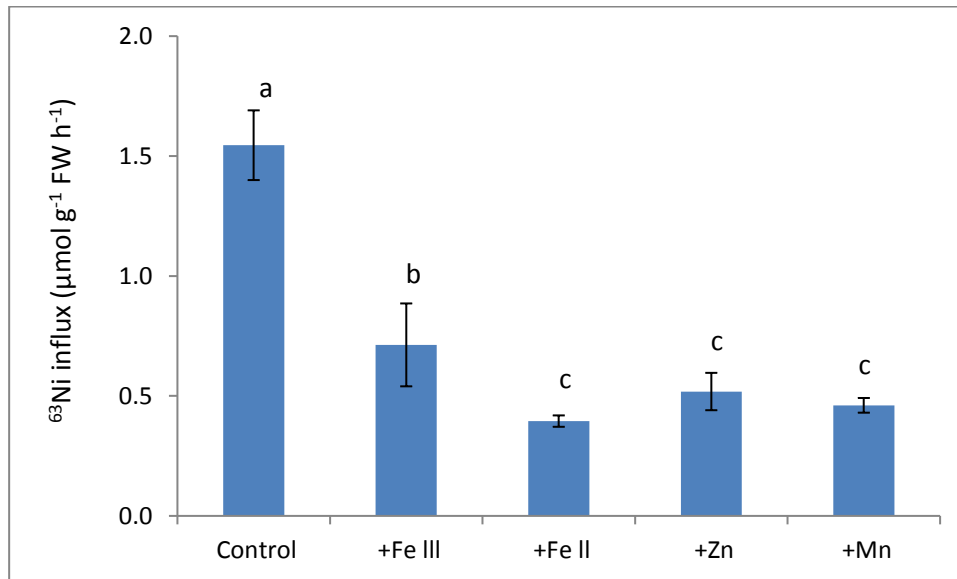

Figure 3.3 Effect on the influx of ^{63}Ni into roots of the addition of micronutrients (FeSO_4 : 5 μM , FeCl_3 : 5 μM , MnCl_2 : 5 μM , and ZnSO_4 : 5 μM) in the nutrient solutions, with a concentration of 1 μM Ni in the uptake solution. All micronutrients were omitted from the uptake solutions except as indicated by each treatment. Uptake time= 4 hours. Values are the mean \pm s.e. (n=4). Different letters above columns designate means which are significantly different.

3.3.4 Effect of different micronutrient deficiencies on influx of Ni

In this experiment, Ni uptake was investigated using short-term radiotracer flux measurements into whole roots. The micronutrient status of the plants was modified by growing them in different treatments, deficient in Mn, Zn or Fe for each of these studies. In the influx solution, only macronutrients were included and not micronutrients with an aim to distinguish the individual effect of different deficiencies on Ni influx while avoiding the competitive interaction with other micronutrient metals that was observed in Fig. 3.3.

The influx of ^{63}Ni over 4 hours was significantly higher in roots of plants deficient in Zn or Fe, but was unaffected by Mn deficiency (Fig. 3.4). ^{63}Ni influx was unaffected by the Ni status of the plants; the influx was the same whether 1 μM Ni (NiCl_2) was included in the growth medium or was omitted (Fig 3.4).

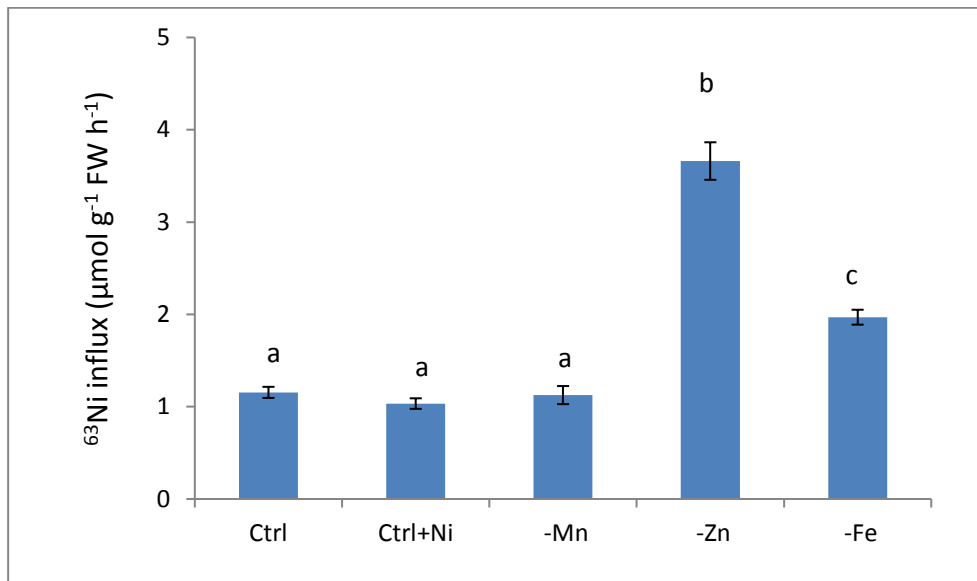

Figure 3.4 Effect of different deficiency conditions on the uptake of ^{63}Ni into roots of barley. For each of the different nutrient conditions, plants were cultured in the respective treatment (full nutrient, Mn-deficient, Zn deficient and Fe deficient conditions). Influx time = 4 h, followed by 0.5 h desorption. The results show the mean \pm s.e. of 4 replicates. Different letters above columns designate means that are significantly different ($P < 0.05$).

3.3.5 Effect of deficiencies on long-term accumulation of Ni

In plants grown for 3 weeks, deficiencies of Fe, Mn and Zn all altered Ni concentrations in both roots and shoots (Fig. 3.5). In roots, there was a 3.5-fold increase in Ni concentration in Fe-deficient roots, but much smaller increases under Zn and Mn deficiencies (Fig 3.5). Ni starvation did not increase Ni influx. Compared to the roots, the Ni concentrations in the shoot were very low, and the effects of nutrient deficiencies more or less opposite to those observed in roots (Fig 3.5).

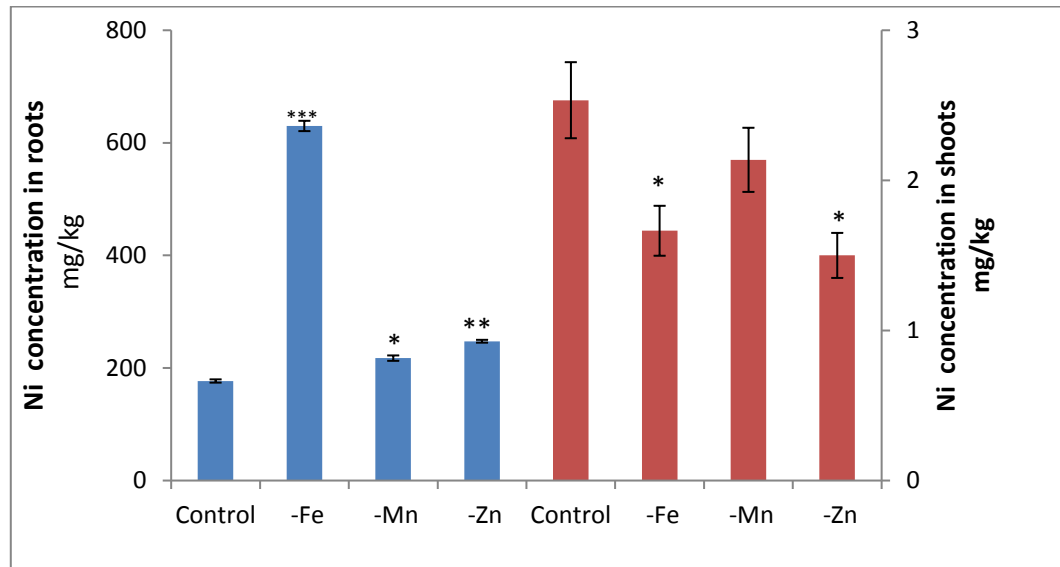

Figure 3.5 Ni concentrations in the roots and shoots of barley cultured in different nutrient conditions for 3 weeks. The first four bars represent roots and the other four shoots. Ni (1 μ M) was added for the final 2 weeks. Values are means \pm SE (n=4). Significant differences are denoted by asterisks: *P< 0.001, **P<0.0001, *** P<0.000001 (t-test) for the values on relevant Y axis.

3.4 Discussion

The results show that the status of other micronutrient cations can affect the uptake of Ni greatly, either through nutrient deficiencies or by the competition for uptake. Fe deficiency strongly stimulated influx (4 h uptake) (Figs 3.2 & 3.4) and long term accumulation (2 week uptake) (Fig. 3.5). Ni influx in unstarved plants was also strongly inhibited by FeIII and FeII in the uptake medium. Zn deficiency had an even greater effect than Fe deficiency on Ni influx (Fig. 3.4) but only a small effect on net tissue concentration (Fig. 3.5). A likely explanation for this is that in the long term experiment, competing micronutrient cations were present in the culture medium, but were absent in the influx measurements in order to see the effect of deficiencies without the complicating effects of competition between micronutrients for uptake. It was shown that Zn, Fe and Mn all strongly suppressed Ni influx (Fig. 3.3), which may lower the long term uptake.

The stimulation of influx by Fe starvation strongly suggests that a main route for Ni uptake is via Fe transporters that are induced by Fe deficiency. The suppression of Ni

uptake by Fe in the uptake medium in both starved and non-starved plants seems to indicate a high degree of discrimination of these transporters between Fe and Ni. This was confirmed in the long uptake experiment where there was a very large increase in Ni uptake when Fe was absent. In *Arabidopsis thaliana*, several studies have also demonstrated an increase in Ni accumulation in Fe-deficient plants (Schaaf et al., 2006; Nishida et al., 2011).

Ni influx was also strongly stimulated by Zn starvation but long term accumulation was only slightly enhanced, possibly because the transporters induced by Zn starvation had greater affinities for Fe or Mn.

Mn deficiency slightly elevated the Ni concentration in the long-term accumulation experiment, but no such stimulation was found in the influx of Ni in the short-term influx experiment of Mn-starved plants. This was likely the result of the very slow and gradual accumulation of Ni in Mn-deficient plants over a period. However, Ni influx was greatly inhibited when Mn was added to the uptake medium of Mn sufficient plants, which indicates that there is strong competition between Ni and Mn.

Ni was not normally added to the growth solutions, and the lack of any significant difference in Ni uptake when Ni was included suggests that perhaps the plants were not deficient and had derived sufficient Ni from seed reserves. Brown et al. (1987) grew plants for three generations in solution culture prepared with highly purified nutrients in order to observe Ni deficiency symptoms.

Comparison of the root concentrations of Ni (Fig. 3.5) and Cd (Table 2.2) show that at the same concentration in the nutrient solution (1 μ M), more than twice as much Cd is absorbed as Ni, despite plants not needing Cd for growth. The data on Ni in shoots show that almost none of the Ni absorbed by the roots was transported to the shoots. Transfer factors were between 0.002 and 0.014 (i.e. 0.2 – 1.4% of root Ni was translocated to the shoots). This finding agrees with the studies on other plants [eg. Soy bean (Cataldo et al., 1978), cabbage (Pandey and Sharma, 2002), wheat (Wang et al., 2009), Maize (Marwa et al., 2012) and field crops (Lavado, 2006)]. Nishida et al. (2015) observed a slight increase in shoot Ni concentration under Zn-deficient conditions, but they had used a much higher Ni concentration in their uptake solution. By comparison, the proportion of Cd transferred to shoots was much higher, with transfer factors around 0.07 (Table 2.2).

Chapter 4

4. Transport of Cd and Ni into shoot protoplasts

4.1 Introduction

Most of the work on divalent metal transporters in barley has focussed on roots, and little is known about the transporters in shoots (Pedas et al., 2008; Pedas et al., 2009). It is known that uptake of heavy metals into roots is affected by the relative concentrations of the competing metal species and also the nutrient status of the plant. However, there is little information about how the transporters in the shoot respond to factors like nutrient status and cation competition, mainly because of the difficulty in observing the transport of metals across the plasma membrane of shoot cells directly inside a plant system. Therefore, in this section, I examined the different factors affecting the plasma membrane transport processes of heavy metals in the shoot using isolated protoplasts. Protoplasts are living cells bounded by only the plasma membrane, ideal for transport studies to investigate metal ion transport through the plasma membrane of shoot/leaf cells. Several studies have analysed the uptake of Cd into the protoplasts isolated from both shoots and roots using heavy metal/Cd-specific fluorescent dye in wheat (Lindberg et al., 2004, 2007; Greger et al., 2016) and *Noccaea caerulea* (Leitenmaier and Kupper, 2011).

For this chapter, fluxes of ^{109}Cd and ^{63}Ni were measured in protoplasts isolated from barley leaf tissue. The effect of nutrient status on the uptake of Cd and Ni into protoplasts was examined using protoplasts isolated from the plants grown in different nutrient conditions. The effect of cation competition on Cd and Ni influx was investigated using protoplasts isolated from plants grown under full nutrient conditions.

4.2 Materials and Methods

4.2.1 Plant material and culture

Plant culture was exactly the same as that for the radiotracer Cd influx experiment (20 L container) into whole roots.

4.2.2 Isolation of protoplasts

The procedure for isolation of protoplasts is described in Mimura et al. (1990). Briefly, the lower surface of barley leaves was abraded to partially remove the epidermis; then leaves were floated on a digestion medium containing 2 % (w/v) cellulase RS (Yakult), 1% (w/v) pectinase (Sigma), 0.6 M sorbitol, 1 mM CaCl₂ and 10 mM MES/Na pH 5.6 for 3 h at 32°C. The protoplasts released were then purified by density gradient centrifugation. The suspension of protoplasts was transferred into 50 ml tubes. The bottom of the tube was layered with P_{SUC} (0.6 M sucrose, 1 mM CaCl₂ and 10 mM MES/Na pH 5.6) below the protoplast suspension with a Pasteur pipette and overlaid with 0.5 ml of P_{GB} (0.6 M glycine-betaine, 1 mM CaCl₂ and 10 mM MES/Na pH 5.6) on top of the protoplast suspension, and centrifuged at 190 g for 10 min. After centrifugation, the top layers were aspirated away to remove epidermal protoplasts, the enzyme solution and P_{GB}. The green layers of mesophyll protoplasts obtained near the bottom of the 50 ml tubes were resuspended with equal volumes of P_{SUC} (~3 ml) in 10 ml tubes. This was mixed by gentle inversion using parafilm strips, and overlaid with 2 ml of a mixture of equal volumes of P_{SOR} (0.6 M sorbitol, 1 mM CaCl₂ and 10 mM MES/Na pH 5.6) and P_{SUC}, and overlaid with 0.5 ml of P_{GB} on top of the tube and centrifuged at 190 g for 10 min. The protoplast layers formed below P_{GB} were collected and kept on ice until used for influx experiments. The protoplasts were counted using a haemocytometer under a microscope. Protoplast density was calculated based on the counts of protoplasts per ml. Experiments were conducted with viable protoplasts at room temperature for up to an uptake period of 40 min.

4.2.3 Uptake of ¹⁰⁹Cd/⁶³Ni into protoplasts

In the absence of any data on relevant apoplastic Cd concentrations in shoot tissues, uptake experiments with protoplasts used either 1 µM or 5 µM Cd. In most experiments,

the uptake of ^{109}Cd into the protoplasts was initiated by the addition of 75 μl of the protoplast solution to 25 μl of ^{109}Cd (4 μM) in an incubation medium containing 0.6 M sorbitol, 1 mM CaCl_2 and 20 mM MES adjusted to pH 5.6 (Psor), giving a final concentration of Cd of 1 μM . However, the final concentration in the incubation media for the first two experiments (Figs 4.1 & 4.2) was 5 μM which was equivalent to ^{55}Fe concentration that used in the comparative study. The influx was terminated by addition of 1 ml of cold incubation medium in which sorbitol was replaced by the less dense glycine betaine solution at the same concentration (Pgb). Rinsing was achieved by injecting cold Psor into the bottom of the tube then centrifuging the protoplasts through this layer. The pellet formed by the protoplasts was rinsed a further four times with Psor, and ^{109}Cd determined by liquid scintillation counting. The methodology for the uptake of ^{63}Ni into protoplasts was similar to the ^{109}Cd uptake experiments, but ^{109}Cd was replaced with ^{63}Ni .

4.2.4 Competition experiments

Plants that were grown in 0.2 Hoagland's nutrient solution for two weeks were used for protoplast isolation in this experiment. In the competition experiments, competition between Cd/Ni and other metals was examined. Zn (5 μM), Mn (5 μM) and Fe (20 μM) were added to the uptake solutions. The uptake of $^{109}\text{Cd}/^{63}\text{Ni}$ into the protoplasts was initiated by the addition of 75 μl of the protoplast solution to 25 μl of ^{109}Cd (4 μM) in an incubation medium containing 0.6 M sorbitol, 1 mM CaCl_2 and 20 mM MES adjusted to pH 5.6 (Psor), giving a final concentration of Cd/Ni of 1 μM .

4.3 Results

4.3.1 Comparison of Cd and Fe uptake in Fe sufficient and Fe deficient plants

Cd and Fe uptake was examined using short-term radiotracer flux measurements into protoplasts isolated from shoots. For this study, the nutrient status of the plants was altered by growing them in either in Fe-sufficient or Fe-deficient culture media. Fe deficiency strongly stimulated both the influx of ^{109}Cd and the influx of ^{55}Fe in shoot protoplasts. The influx of ^{55}Fe was 77.3 pmol/ 10^5 protoplasts $^{-1}$, and ^{109}Cd was 37.4 pmol/ 10^5 protoplasts $^{-1}$ in Fe-deficient plants. In Fe-sufficient plants, the influx of ^{109}Cd decreased to 20.2 pmol/ 10^5 protoplasts $^{-1}$ and influx of ^{55}Fe decreased to 12.9 pmol/ 10^5 protoplasts $^{-1}$ (Fig. 4.1).

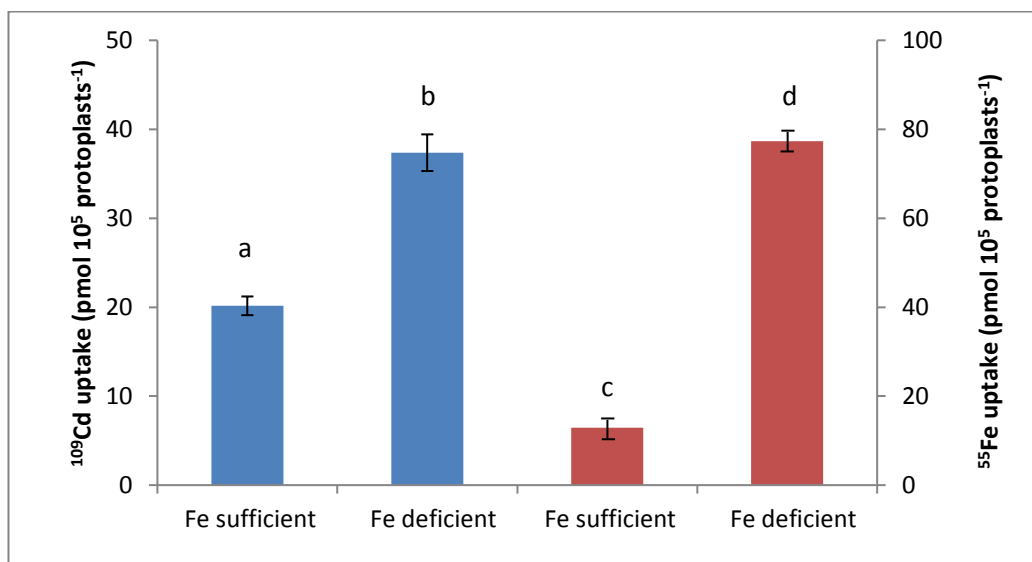

Figure 4.1 Effect of Fe nutrition on the uptake of ¹⁰⁹Cd (5 μM) and ⁵⁵Fe (5 μM) into protoplasts isolated from leaves of barley plants grown under Fe deficiency and sufficiency conditions. Influx time = 20 min. Values are the mean ± s.e. (n=4). Different letters above columns designate means that are significantly different (P<0.05).

4.3.2 Comparison of Cd and Fe uptake in non-deficient and Mn, Zn & Cu deficient plants

For this study, the nutrient status of the plants was altered by growing them in either in non-deficient or Mn, Zn & Cu starved but Fe-sufficient culture medium. The influx of ¹⁰⁹Cd was strongly stimulated into shoot protoplasts in plants that were Fe-sufficient but deficient of other micronutrient metals (Zn, Mn and Cu) (Fig. 4.2).

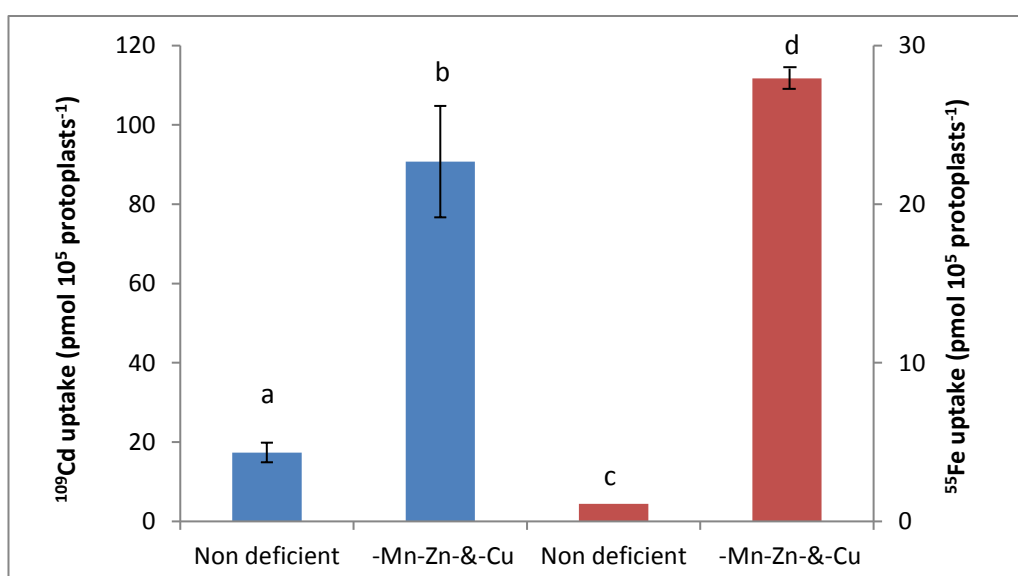

Figure 4.2 Effect of nutrient status on the uptake of ^{109}Cd ($5\ \mu\text{M}$) and ^{55}Fe ($5\ \mu\text{M}$) into protoplasts isolated from leaves of barley plants grown under Mn, Zn and Cu deficiency (-Mn,-Zn & -Cu) and sufficiency conditions (Non-deficient). Influx time = 20 min. Values are the mean \pm s.e. ($n=4$). Different letters above columns designate means that are significantly different ($P<0.05$).

4.3.3 Competition between metals and Cd for uptake

The effect of elevated concentrations of potential competing cations on Cd influx was examined using plants grown under nutrient-sufficient conditions. This showed that Cd influx was significantly inhibited when Zn was added to the uptake solution, while Mn had no effect on the influx. Perhaps significantly, FeI significantly increased rather than decreased the flux of Cd, albeit at a relatively high concentration (Fig. 4.3).

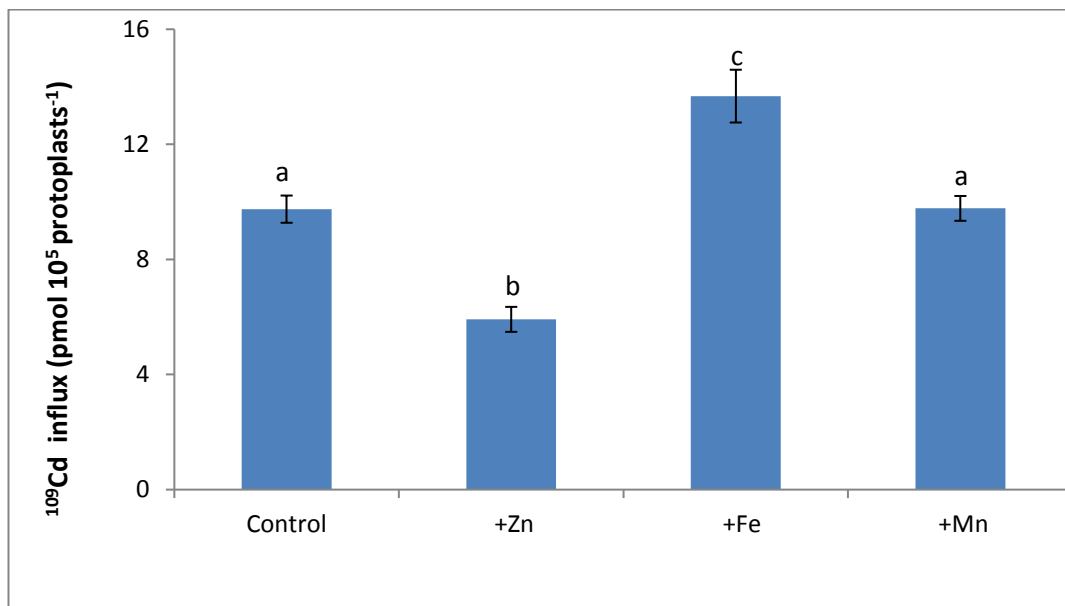

Figure 4.3 Effect on the influx of ^{109}Cd into shoot protoplasts of the addition of elevated micronutrient concentrations (FeSO_4 : $20\ \mu\text{M}$, MnCl_2 : $5\ \mu\text{M}$, and ZnSO_4 : $5\ \mu\text{M}$). Cd in the uptake solution was $1\ \mu\text{M}$. Protoplasts were isolated from plants grown in complete nutrient for two weeks. Uptake time = 20 min. Values are the mean \pm s.e. ($n=4$). Different letters above columns designate means that are significantly different.

4.3.4 Competition between metals and Ni for uptake

The effect of increasing concentrations of potential competing cations on Ni influx was examined using protoplasts isolated from the plants grown under complete nutrient conditions. Ni was much less sensitive than Cd to the presence or absence of other metal cations in the uptake solution. Higher concentrations of Zn, Mn and Cd had no effect on influx but additional FeII caused a slight increase in the influx of Ni. The influx of Ni into shoot protoplasts was much lower than that of Cd at the same concentration. This agrees with the lower shoot Ni concentration in the nutrient analysis experiment in all of the treatments (Table 2.2, Fig. 3.3).

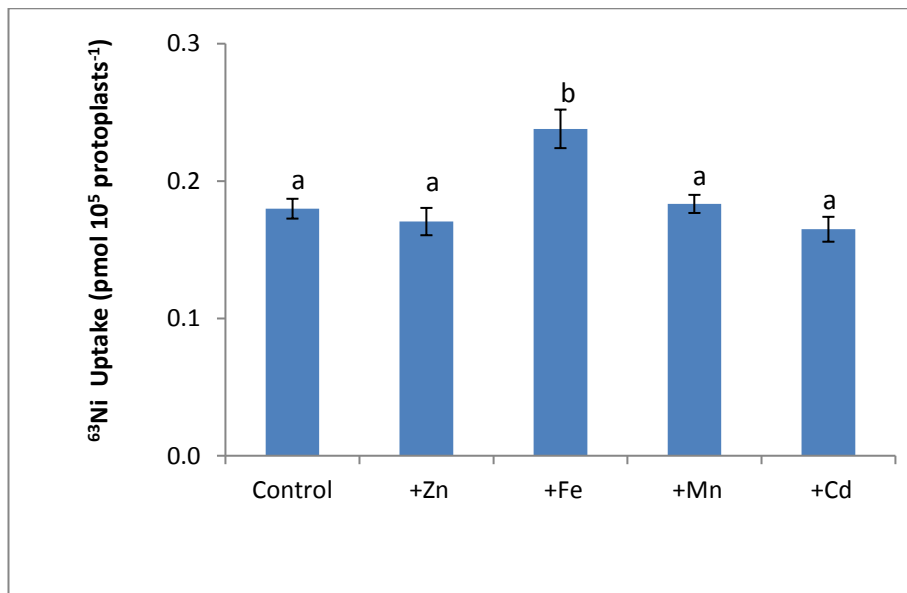

Figure 4.4 Effect on the influx of ⁶³Ni into shoot protoplasts of the addition of elevated micronutrient concentrations (FeSO₄: 20 μM, MnCl₂: 5 μM, ZnSO₄: 5 μM and CdCl₂: 5 μM). Ni in the uptake solution was 1 μM. Protoplasts were isolated from plants grown in complete nutrient solution for two weeks. Uptake time = 20 min. Values are the mean ± s.e. (n=4). Different letters above columns designate means which are significantly different.

4.3.5 Effect of nutrient status on the uptake of Cd into shoot protoplasts

The influx of ^{109}Cd was strongly stimulated by Mn deficiency in shoot protoplasts, moderately stimulated by Fe deficiency but inhibited by Zn deficiency (Fig.4.5).

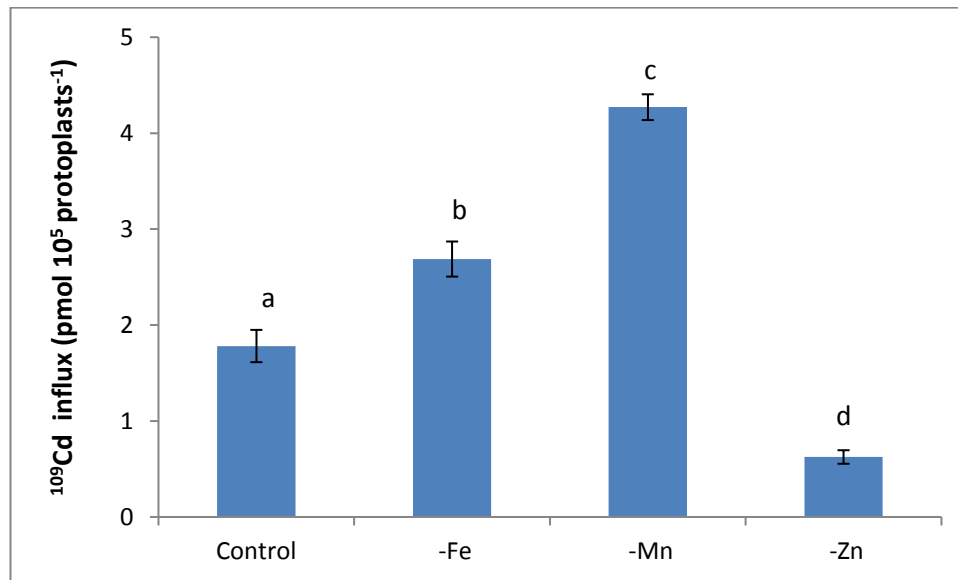

Figure 4.5 Effect of nutrient conditions on the uptake of ^{109}Cd into protoplasts isolated from leaves of barley plants grown under deficiency conditions. Influx time = 20 min. Values are the mean \pm s.e. (n = 4). Different letters above columns designate means which are significantly different ($P < 0.05$).

4.3.6 Effect of nutrient status on the uptake of Ni into shoot protoplasts

The influx of ^{63}Ni was strongly stimulated by Fe and Mn deficiency in shoot protoplasts but slightly inhibited by Zn deficiency. Inclusion of Ni in the growth solution did not affect ^{63}Ni influx into protoplasts (Fig. 4.6).

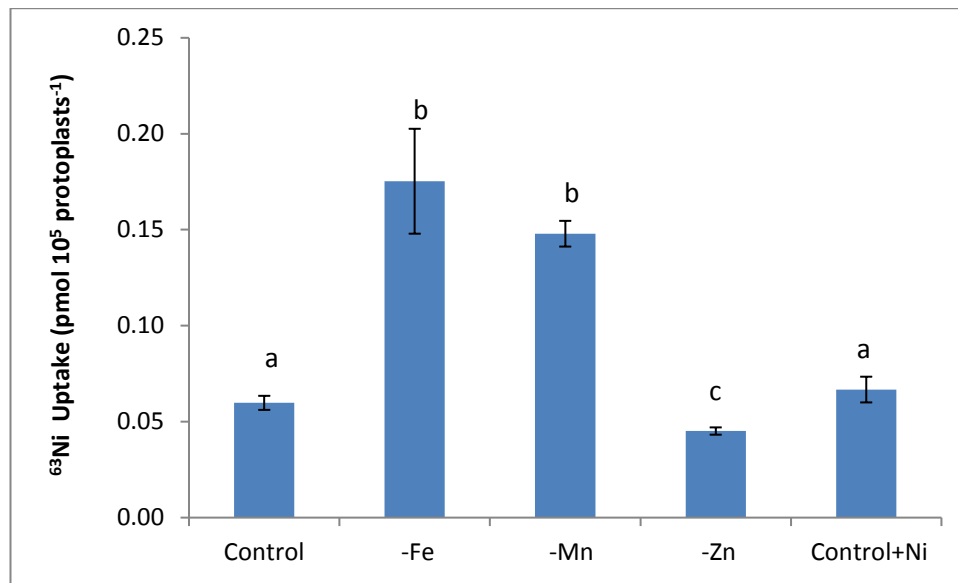

Figure 4.6 Effect of nutrient conditions on the uptake of ^{63}Ni into protoplasts isolated from leaves of barley plants grown under deficiency conditions. Influx time = 20 min. Values are the mean \pm s.e. (n =4). Different letters above columns designate means which are significantly different (P<0.05).

4.4 Discussion

The results show that micronutrient status has a major impact on the uptake of ^{109}Cd into the shoot protoplasts (Figs 4.1 and 4.2). The strongest effect on Cd uptake was observed in treatments in the plants that were deficient in Zn, Mn and Cu; in fact, the Cd influx was three-fold higher than Fe influx in those plants. On the other hand, the Fe influx was two-fold higher than Cd influx in Fe-deficient plants.

The follow-up experiments focused on the specific effect of each micronutrient on the uptake of Cd (1 μM), similar to the root uptake experiment conditions in Chapter 2. It is clear from the protoplast results that transporters in the shoot do in fact respond to plant nutrient status, but not in a way that can be predicted from root uptake. Unlike in roots, the Cd influx into shoot protoplasts was inhibited by Zn deficiency but strongly stimulated by Mn deficiency and moderately stimulated by Fe deficiency (Fig. 4.5). In contrast, Zn in the influx solution inhibited Cd influx while Fe caused a slight increase, and there was no effect of Mn (Fig. 4.3). The reason for this diverging result is not clear. However, it is important to note that the effect of increasing the concentration of potential competing cations on Cd influx was examined using protoplasts isolated from the plants grown only under full nutrient conditions. This is the first study reporting the effect of nutrient status and cation competition on Cd uptake into leaf protoplasts. Further investigations are necessary to unfold the reasons for the inhibitory effect of Zn deficiency on the uptake of Cd into shoot protoplasts.

It is likely that the interaction of different transport systems could be possible in the transport of Cd from the root to shoot in barley. Fontanili et al. (2016) suggested the possible involvement of Zn-insensitive transport system in the root to shoot translocation of Cd in addition to the potential role of a Zn transporter (OsHMA2) in rice. These findings further support the possible involvement of transporters other than a Zn transporter since Mn and Fe deficiencies stimulated the Cd influx into shoot protoplasts.

Although the influx of Ni into the leaf protoplasts was found to be much lower than Cd influx in all of the different nutrient conditions, the Ni influx shows a similar pattern to Cd to some extent, where both Fe and Mn deficiency strongly stimulated Ni influx but influx was slightly inhibited by Zn deficiency (Fig. 4.6). On the other hand, the inclusion in the uptake solution of Zn, Mn or Cd did not affect Ni influx, while Fe caused

a slight increase (Fig. 4.4). This study has specifically examined, for the first time, the effect of nutrient status and cation competition on Ni uptake into leaf protoplasts.

Chapter 5

5. Cd distribution between cytoplasm and vacuole

5.1 Introduction

Non-essential metals like Cd, and also essential metals in excess, can disturb intracellular processes due to their high reactivity in the cytoplasm (Clemens, 2006; Schneider et al., 2009). Plants have developed different strategies to deal with the accumulation of metal ions in the cytoplasm, to detoxify non-essential metals and also to maintain the concentration of essential metals within the optimal functional range (Clemens, 2001). One such mechanism is to move these metals into the vacuole to isolate them from the metabolic compartments in the cytoplasm (Martinoia et al., 2007; Conte and Walker, 2011). Vacuolar compartmentalization/sequestration is an important mechanism in plants for maintaining heavy metal homeostasis, by acting as a temporary or permanent store of metal ions.

Two proton pumps on the vacuolar membrane (tonoplast), an ATPase and a PPase play a crucial role in the removal of non-essential and excess essential metals from the cytoplasm to the vacuole by energising the vacuolar membrane (Maeshima, 2001). These pumps generate electrochemical gradients that can be utilised to drive movement of cations by proton antiport mechanisms, or movement of anions due to the membrane potential difference (vacuole more positive than the cytoplasm). The uptake of ions is mediated by transporters and channels on the vacuolar membrane. Certain transporters, for example ABC transporters, can be directly energised by MgATP (Martinoia et al., 2000).

The vacuolar membrane contains a range of metal ion transporters that coordinate heavy metal homeostasis in plants (Martinoia et al., 2007; Sharma et al., 2016; Zhang et al., 2018). Over the past two decades, much progress has been made in the identification and characterisation of tonoplast heavy metal transporters. However, the mode of action and underlying mechanisms of these fundamental processes is still

mostly unknown and continues to be a challenging area of study and research (Martinoia et al., 2012). It is known that for most ions, more than one transporter exists at the vacuolar membrane (Martinoia et al., 2000). The lack of specificity of these transporters allows for competitive transport of a diversity of non-essential heavy metal ions (Sharma et al., 2016). The metals might be transported into the vacuole either free or conjugated with thiol compounds. The thiol compounds are produced in plants as a protective mechanism to complex toxic metal (loid)s such as Cd and As that enter cells (Cobbett, 2000). The main thiol compounds involved in metal chelation in the cytosol are based on glutathione, a tripeptide containing cysteine whose thiol side group has high affinity for a range of heavy metals. Oligomers of glutathione, phytochelatins, bind Cd more strongly. These metal-thiol complexes may be transported into the vacuole intact (Martinoia et al., 2000; Verbruggen et al., 2009).

Different studies have shown that thiol compounds (GSH and PCs) are required for heavy metal (loid) tolerance (Guo et al., 2008; Xu et al., 2017;). Several studies have highlighted the role of phytochelatins in the chelation and sequestration of Cd into vacuoles (Gupta et al., 2004; Semane et al., 2007; Prévéral et al., 2009; Mendoza-Cózatl et al., 2010; Brunetti et al., 2015). However, most of the work so far has come from a genomic background, and only a few studies have made direct measurements PC-heavy metal (loid) vacuolar transport study using isolated vacuoles. Song et al. (2014) showed that barley vacuoles incubated with PC₂ readily accumulated Cd. The transport was sensitive to vanadate, an inhibitor of ABC-type transporters. They concluded that at least some of the transport of Cd to the vacuole occurred as PC₂-Cd complexes mediated by ABC transporters. Although a stimulatory effect of ATP on PC₂-Cd transport to the vacuole was demonstrated (Song et al., 2014), it is not clear whether the chelation of Cd is essential for transport to the vacuole or whether Cd can be transported through the tonoplast as free ions.

As noted above, compartmentation of Cd in vacuoles may be an effective strategy to isolate Cd from enzymes and other metabolites within the cytoplasm. In higher plants, several studies have suggested that most of the cellular Cd is located in vacuoles (Vögeli-Lange and Wagner, 1990; Ramos et al., 2002; Wójcik et al., 2005). Other studies have provided evidence that Cd is distributed in several cellular compartments. In *Agrostis* and maize roots, Cd was associated with electron-dense granules in the

cytoplasm, vacuoles and nuclei when exposed to 3 μM Cd (Rauser and Ackerley, 1987). In *Phaseolus vulgaris*, a similar finding was reported in roots when exposed to 0.5 μM Cd (Vázquez et al., 1992).

In this chapter, I investigated the roles of ATP and GSH in the uptake of Cd into vacuoles. I then examined whether there was competition for uptake into the vacuole between Cd and Zn or Mn. Finally, I conducted experiments to try to determine how much cellular Cd was actually sequestered into vacuoles.

5.2 Materials and Methods

5.2.1 Plant culture

Barley (*Hordeum vulgare* var. Schooner) seeds were germinated on paper towel moistened with deionised water for three days, and then seedlings were transferred to 3 L tubs containing 0.2 Hoagland's solution for 10 days.

5.2.2 Protoplast isolation

Protoplasts were isolated as described in the previous chapter. Briefly, the lower surface of barley leaves was peeled or abraded to partially remove the epidermis; then leaves were floated on a digestion medium containing 2 % (w/v) cellulase RS (Yakult), 1% (w/v) pectinase (Sigma), 0.6 M sorbitol, 1 mM CaCl_2 and 10 mM MES/Na pH 5.6 for 3 h at 32°C. The protoplasts released were purified by density gradient centrifugation.

5.2.3 Vacuole isolation

The procedure for isolation of vacuoles by Mimura et al. (1990) was slightly modified to remove sucrose from the medium because sucrose is known to make the vacuoles heavier with increasing time, presumably by penetration across the tonoplast. This can make it difficult to isolate the vacuoles by floatation in transport assays.

To obtain vacuoles for transport studies, purified protoplasts were first resuspended with an equal volume of medium A [0.5 M sorbitol, 30 mM HEPES (pH 7.4), 2 mM EGTA, 30 mM potassium gluconate, 2 mM MgCl_2 with 40% of percoll], and overlaid

with 3 ml of medium B [0.5 M sorbitol, 30 mM HEPES, 2 mM EGTA, 30 mM potassium gluconate, 2 mM MgCl₂] and overlaid with 0.5 ml of medium C [0.5 M glycine betaine, 30 mM HEPES, 2 mM EGTA, 30 mM potassium gluconate, 2 mM MgCl₂] and centrifuged at 190 g for 1-2 min, then at 1680 g for 8 min in order to remove the protoplasts of the same density as the vacuoles. The intact protoplasts that accumulated at the interface between the layers of medium A and medium B were collected and lysed mechanically by pipetting the suspension up and down several times with an uncut blue pipette tip. Neutral red, which accumulates in vacuoles due to their low pH, was used to stain the vacuoles so that they could be visualised easily. To purify vacuoles released from the protoplasts, the lysate was mixed with an equal volume of medium A and the suspension mixed by inversion, overlaid with medium B and top-layered with medium C and centrifuged once again. Most of the vacuoles formed a layer below medium C, and the heavier vacuoles were distributed within the medium B layer. The unlysed protoplasts formed a layer just below the B layer. The entire fraction below medium C and above unlysed protoplasts was taken into a clean tube and kept on ice. The unlysed protoplasts were re-pipetted to try to increase lysis and the purification steps repeated. The vacuoles released from these steps were resuspended in medium A, overlaid with 0.5 ml of medium C and centrifuged to concentrate the vacuole preparation. The vacuoles that settled as a layer after centrifugation just below medium C were used for transport assays. Some images illustrating the various stages of vacuole isolation are shown in Fig. 5.1.

The vacuoles were counted under a microscope using a haemocytometer. Vacuole density was calculated based on the counts of vacuoles per ml. Majority of the vacuoles were strongly stained with a large accumulation of neutral red. The purified vacuoles after the isolation procedure were used straight away for the transport assays without any delay. The uptake time (15 min) for the vacuolar transport assays was determined by various trial experiments based on the viability of vacuoles at room temperature.

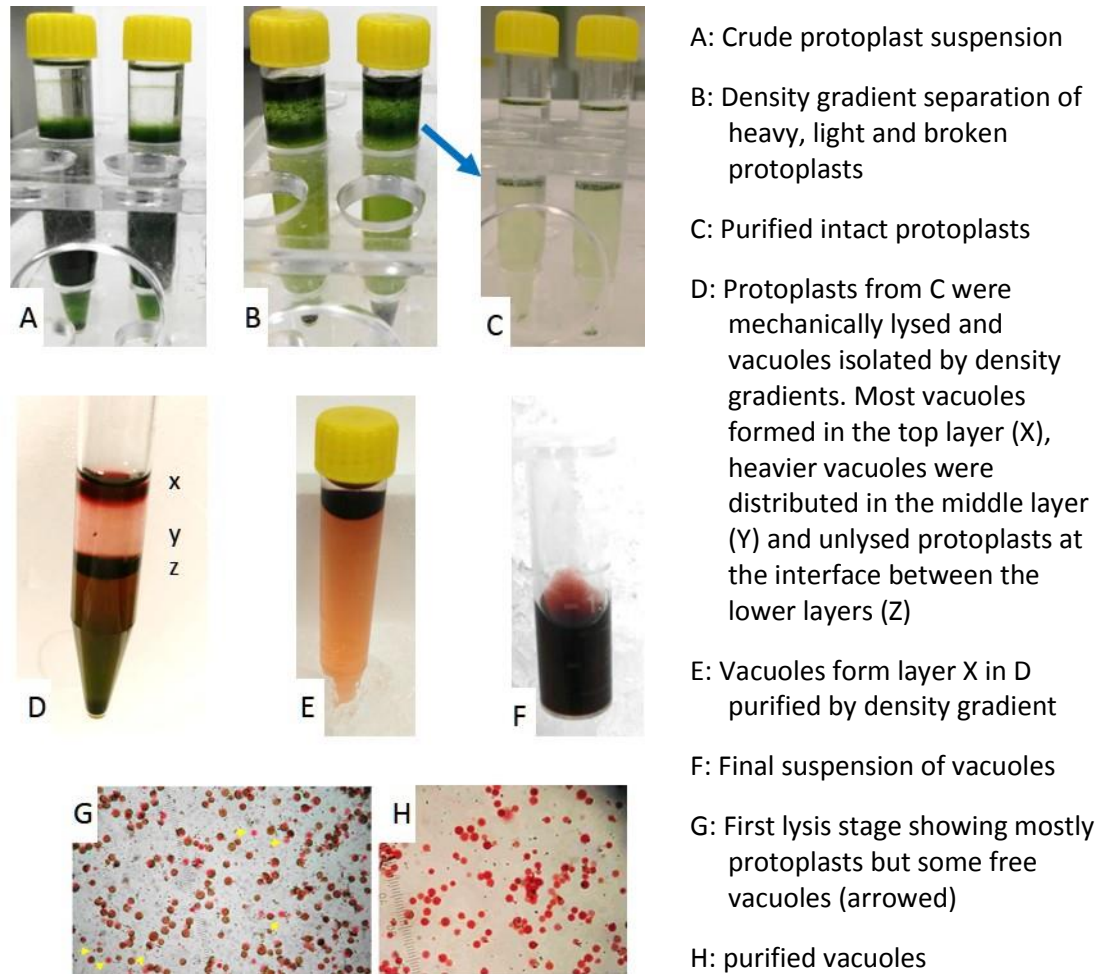

Figure 5.1. Stages in the isolation of vacuoles.

5.2.4 Measurement of ^{109}Cd uptake into vacuoles

Uptake of ^{109}Cd was assayed using the method described by Martinoia et al. (1993). For each condition and time point, four 400 μL polyethylene microcentrifuge tubes were firstly loaded with 70 μL of transport buffer [22% (v/v) Percoll, 500 mM sorbitol, 30 mM KCl, 20 mM HEPES-KOH (pH 7.4), 0.1% BSA, ± 4 mM ATP, 4 mM MgSO_4 ± 3 mM GSH, 1 mM DTT containing 1 μM ^{109}Cd]. The assays were started by adding 30 μL of vacuole suspension, then 200 μL of silicone oil (AR 200) and 60 μL of deionised water were rapidly overlaid on the mixture. After incubation, vacuoles were floated from the radioactive layer up through the silicone layer and into the water phase by centrifugation at 8040 g for 40 s. Radioactivity released from the vacuoles in the aqueous phase was measured using a liquid scintillation analyser.

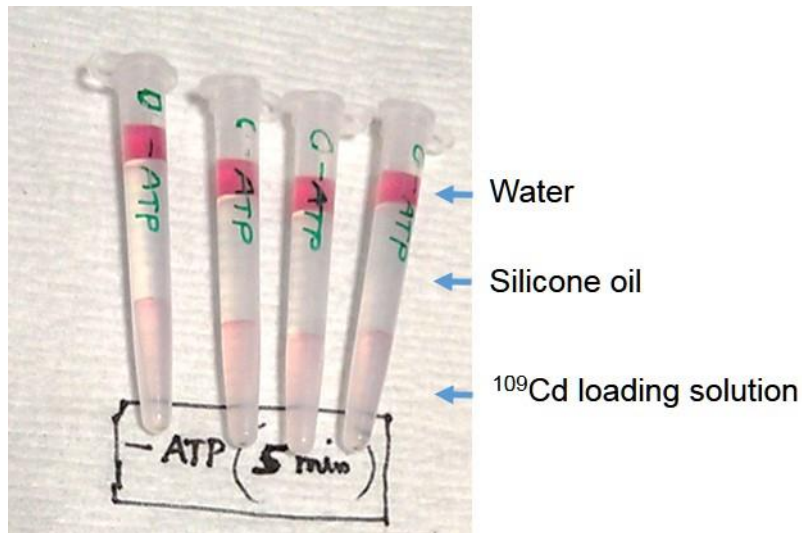

Figure 5.2 Arrangement for measuring ^{109}Cd uptake into vacuoles. The image shows the release of neutral red-stained vacuole contents in the upper aqueous phase following floatation through the silicone layer during centrifugation.

5.2.5 Distribution of Cd between cytoplasm and vacuole

To examine the compartmentation of Cd within cells, the concentration of Cd in whole protoplasts and isolated vacuoles was measured. In the first experiment, protoplasts were incubated in a medium containing ^{109}Cd for 40 mins prior to isolation of the vacuoles. In the second experiment, plants were grown for 1 week in ^{109}Cd before isolation of protoplasts and vacuoles.

5.3 Results

5.3.1. The effect of ATP and GSH on the uptake of Cd into vacuoles

A significant stimulation of Cd uptake was observed when ATP was added. On the other hand, addition of GSH, either with or without ATP, markedly increased Cd influx (Figs 5.3 & 5.4), but more so when ATP was present (Fig. 5.4).

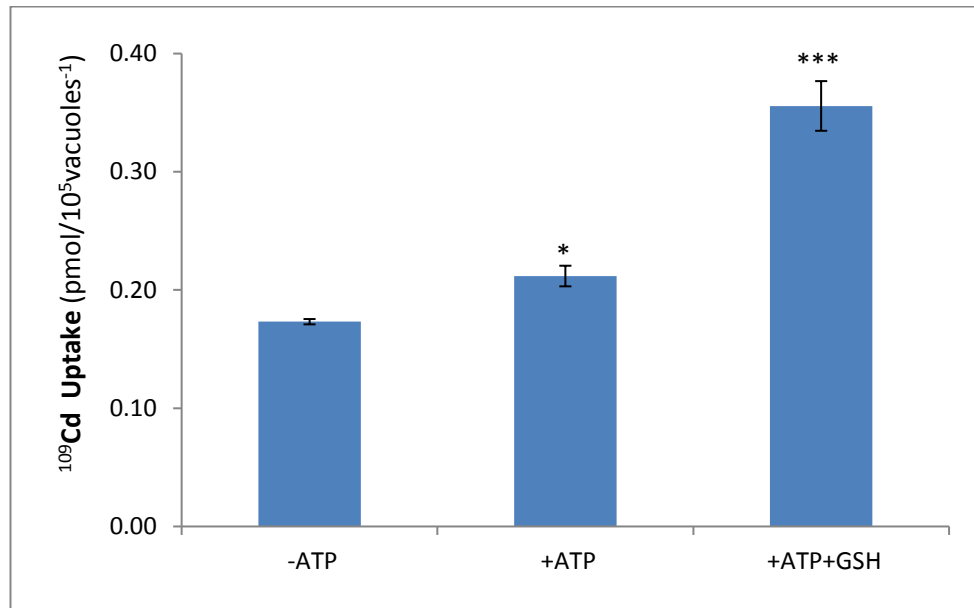

Figure 5.3 Cd concentrations in barley vacuoles after an incubation period of 15 minutes in the absence of Mg-ATP, in the presence of Mg-ATP and also in the presence of Mg-ATP with GSH. Cd was added to a final concentration of 1 μM in the assay buffer. Values are the mean \pm s.e. (n=4). *P<0.05, *** P<0.01 (t-test).

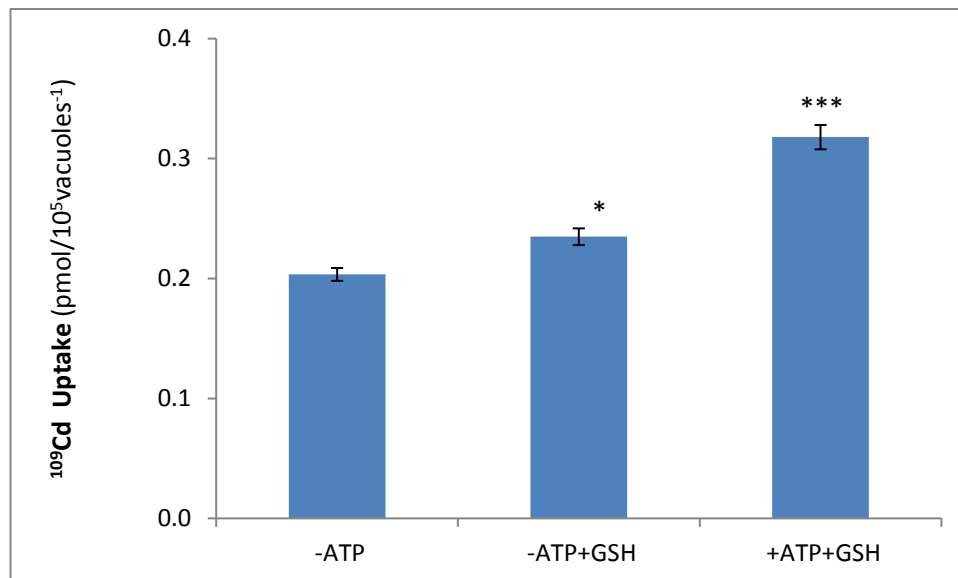

Figure 5.4: Effect on Cd uptake into vacuoles of the addition of GSH with or without MgATP. Cd was added to a final concentration of 1 μM in the assay buffer. Values are the mean \pm s.e. (n=4).*P<0.05, *** P<0.01 (t-test)

5.3.2. Competition with Zn and Mn

The addition of Zn or Mn to the influx medium slightly reduced Cd influx, but the differences were not significant (P-value 0.1) (Figs 5.5 and 5.6).

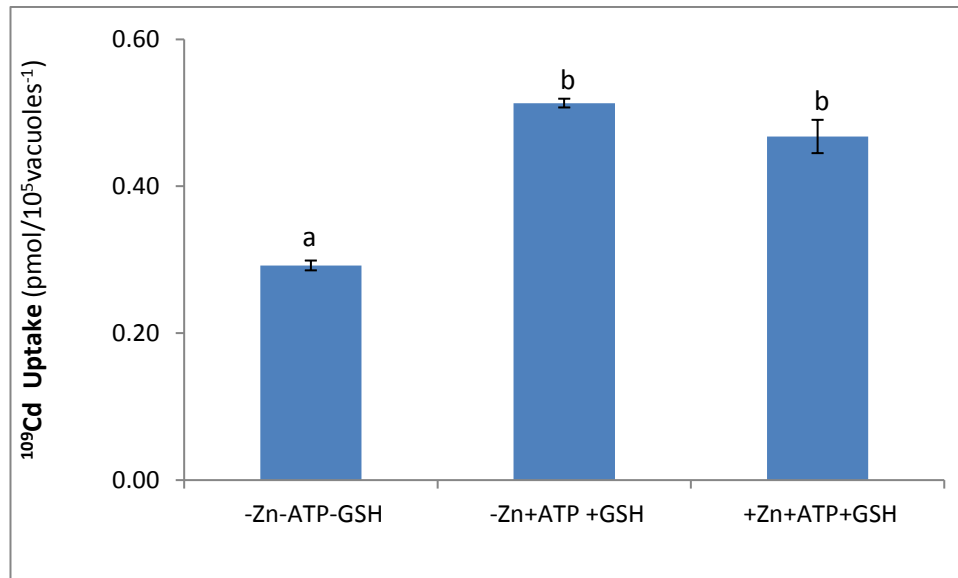

Figure 5.5 Effect on the influx of ^{109}Cd into shoot vacuoles with the addition of Zn concentration (ZnSO_4 : 5 μM). GSH was also supplied with ATP treatments. Cd in the uptake solution was 1 μM . Vacuoles were isolated from plants grown in full nutrient for 10 days. Uptake time = 15 min. Values are the mean \pm s.e. (n=4). Different letters above columns designate significant difference between treatments (P<0.05).

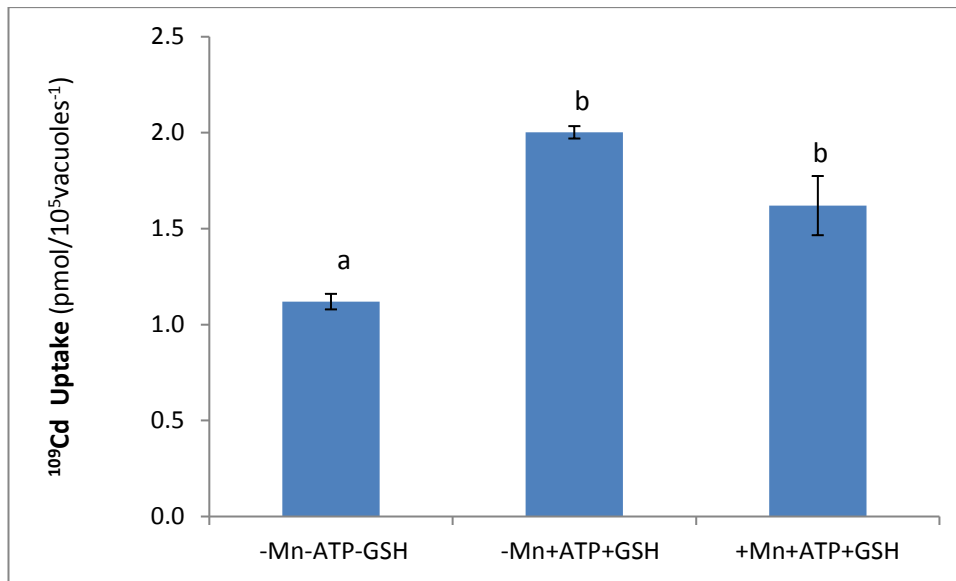

Figure 5.6 Effect on the influx of ^{109}Cd into shoot vacuoles with the addition of Mn concentration (MnSO_4 : 5 μM). GSH was also supplied with ATP treatments. Cd in the uptake solution was 1 μM . Vacuoles were isolated from plants grown in full nutrient for 10 days. Uptake time = 15 min. Values are the mean \pm s.e. ($n=4$). Different letters above columns designate means which are significantly different.

5.3.4 Cd distribution between cytoplasm and vacuoles

Attempts to quantify the concentrations of Cd in vacuole and cytoplasm were complicated by the fact that slight variations in growth conditions and isolation conditions produced vacuoles and protoplasts with different size distributions. There was also uncertainty as to whether lysis of protoplasts was uniform across the range of protoplast sizes, potentially leading to an over representation of vacuoles from smaller or larger protoplasts. For the experiment in which isolated protoplasts were incubated in ^{109}Cd for 40 mins before isolation of the vacuoles, the average volume of vacuoles was 52% of the average volume of protoplasts (50 measurements). To obtain an estimate of the relative volume of vacuoles, protoplasts were stained with neutral red which preferentially accumulates in vacuoles due to their higher acidity than the cytoplasm. The relative vacuolar volume measured in intact protoplasts was 56%, which is similar to that measured in the short-term ^{109}Cd uptake experiment. However, in the experiment in which intact plants were exposed to ^{109}Cd for one week before isolation

of protoplasts, the relative vacuolar volume was only 35%. Sizes of protoplasts and vacuoles can be reduced if the bathing medium is hyperosmotic. Kutsuna and Hasezawa (2005) found the volumes of protoplasts, and of vacuoles contained in them, shrunk by similar amounts (i.e. the ratio of vacuole to protoplast remained constant as the external osmolarity increased). However, when vacuoles are isolated and bathed in different media, their volumes may change according to the osmolarity of the medium, which may be higher or lower than the protoplast medium. This phenomenon may explain the differences in vacuolar volume between the short-term and long-term Cd uptake experiments. An assumption could be made that the correct *relative* volumes of vacuoles and protoplast are those recorded in intact protoplasts, even if these are different to the *actual* volumes in the intact leaf. If this assumption is valid, then the *proportions* of Cd in vacuoles and protoplasts can be accurately calculated using the relative volumes before vacuoles were released. However, the true concentrations, as opposed to the relative concentrations, may be affected by the degree of shrinkage experienced during protoplast isolation.

Comparisons for the distributions of vacuole sizes in intact protoplasts and following isolation, are shown in Fig. 5.7.

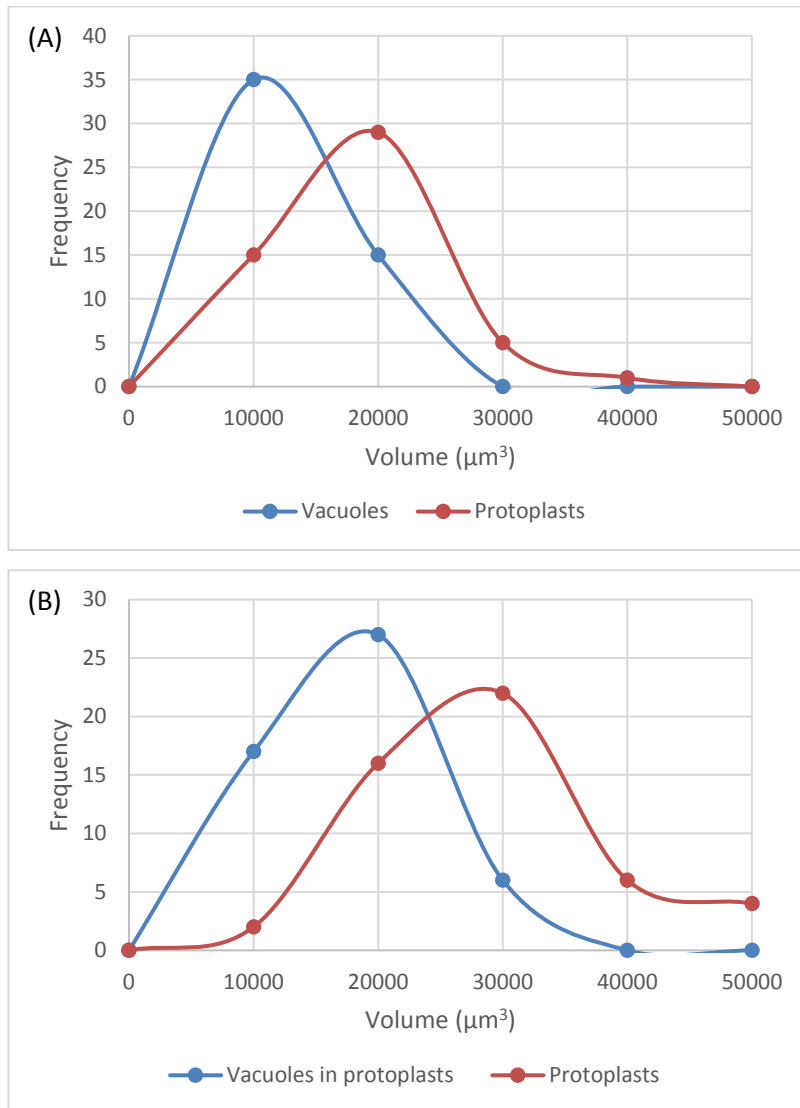

Figure 5.7 Volume distribution of vacuoles used in the measurement of ^{109}Cd content of protoplasts and vacuoles used in the short term uptake experiment (A), and average volumes of vacuoles measured in intact protoplasts (B).

In the protoplast loading experiment, where the uptake period of protoplasts was 40 minutes, the concentration of Cd in the protoplasts reached $0.60 \mu\text{M}$. The concentration in the vacuole would therefore be $0.12 \mu\text{M}$ if the vacuoles occupied 52% of the protoplast volume, or $0.11 \mu\text{M}$ if the volume was 56%. The concentration of Cd in the cytoplasm would be $1.12 \mu\text{M}$ (52% vacuole), or $1.22 \mu\text{M}$ (56% vacuoles).

In the root loading experiment in which plants were grown in ^{109}Cd for 7 days, the concentration of Cd in the isolated protoplasts was $85.7 \pm 0.5 \mu\text{M}$. If the vacuoles occupied 56% of the protoplasts (pre-isolation values) the concentration of Cd in

vacuoles would be $140 \pm 4 \mu\text{M}$, and $14 \pm 2 \mu\text{M}$ in the cytoplasm. The data are summarised in Table 5.1 and Fig. 5.8.

Table 5.1 Concentration of Cd in protoplasts and vacuoles, and calculated concentration of Cd in the cytoplasm, based on the measured volumes of the protoplasts and the relative volume of vacuoles in intact protoplasts (56%).

Uptake time	Cd concentration (μM)			% in cytoplasm
	Protoplasts	Vacuoles	Cytoplasm	
40 mins	0.60	0.11	1.22	89.5
7 days	85.7	142.0	14.2	16.5

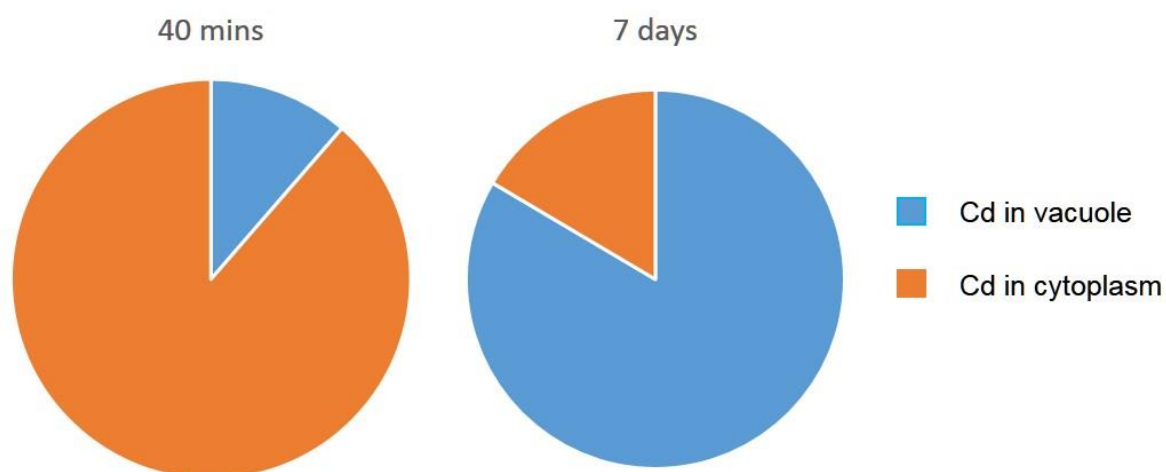

Figure 5.8: Partitioning of Cd in cytoplasm and vacuole in barley leaf mesophyll cells. Protoplasts were either incubated in $1 \mu\text{M}^{109}\text{Cd}$ for 40 minutes prior to isolation of vacuoles, or ^{109}Cd was supplied to roots in the growth medium for 1 week before isolation of vacuoles from the leaves.

5.4 Discussion

Various factors and mechanisms related to the compartmentalisation of Cd into the vacuole were analysed in this chapter and it was found that both ATP and GSH have a role in the vacuolar transport of Cd. The results give more clarity to the dominant form of Cd transport to the vacuole, whether it is transported as free ions or complexed with thiol compounds, and also its energy dependency. The addition of ATP increased Cd uptake significantly in the absence of GSH (Fig. 5.3). On the other hand, the inclusion of GSH in the absence of ATP also markedly increased Cd uptake (Fig 5.4). The highest Cd influx was observed when GSH and ATP were presented simultaneously (Fig. 5.4). These results show that Cd may be transported either as Cd²⁺ ions or as Cd-GSH complexes. However, the large stimulation with GSH suggests that a major proportion of Cd is transported in the complexed form. This is in agreement with the results of Song et al. (2014) on the transport of PC-Cd to barley vacuole, which is also Mg-ATP-dependent. Additionally, these results predict that vacuolar Cd transport could be most likely through an ABC-type transporter, as suggested by other studies (Song et al., 2010; Park et al., 2012; Song et al., 2014). I am unaware of any other studies that specifically examined the effect of GSH in the transport of Cd into the vacuole using isolated vacuoles.

There was significant uptake of Cd into vacuoles even in the absence of ATP. Given that the inside of the vacuole is likely to be positive with respect to the outside (normally cytoplasm), passive uptake of Cd seems unlikely. An alternative explanation for the apparent uptake in the absence of ATP, is that it is due to non-specific ¹⁰⁹Cd binding on the outside of the vacuoles, which was not removed during the passage through the silicone layer. If this can be considered background, and subtracted from all treatments, then the stimulations due to ATP and GSH are much larger.

The only micronutrient that inhibited Cd influx into shoot protoplasts was Zn (Fig. 4.3). Similar to that experiment, the competition for transport into the vacuole between Cd and Zn was also investigated, but Cd transport to the vacuole was not affected by the addition of Zn (Fig. 5.5) nor by Mn (Fig 5.6). Hence these results demonstrate that there is no competition between Cd and either Zn or Mn for transport to the vacuole. Song et

al. (2014) reported enhanced uptake of PC_2 into vacuoles when Zn, Cu or Mn were added to the uptake medium, but they did not specifically measure transport of these metals.

Finally, the partitioning studies have demonstrated how much cellular Cd was actually sequestered into vacuoles. With short influx times, most of the Cd was found in the cytoplasm. After one week, the Cd concentration in the vacuole was 10-fold higher than in the cytoplasm (Table 5.1 & Fig.5.8). For this to happen, Cd would have to be actively transported against its electrochemical gradient into the vacuole, which may explain the stimulatory effects of ATP and GSH in the previous experiments (Figs. 5.3 & 5.4). Whether there is also active efflux of Cd across the plasma membrane is briefly investigated in Chapter 6.

Several studies have suggested that cellular Cd accumulates mostly in the vacuoles (Vögeli-Lange and Wagner, 1990; Ramos et al., 2002; Wójcik et al., 2005), but they were not based on quantitative measurement of the partitioning of Cd between the cytoplasm and vacuole. In *Noccaea caerulea* (hyperaccumulator), Ma et al. (2005) reported that the entire Cd in the protoplast was located in the vacuoles, based on the measurement of the concentration of Cd in the isolated protoplast and vacuoles using atomic absorption spectrometry. However, the plants used for the isolation of protoplasts and vacuoles were exposed to a toxic range of Cd concentration (50 μ M) for a longer period (two months). For this partitioning study, the plants used for the isolation of protoplasts and vacuoles were exposed to a low and environmentally relevant concentration of Cd (1 μ M). In accordance with the present results, the initial accumulation of Cd in the cytoplasm and subsequent slow sequestration of Cd into the vacuole was demonstrated in a study that used Cd-specific fluorescent dye in *Noccaea caerulea* (Leitenmaier and Kupper, 2011).

The current study has quantified cytoplasmic and vacuolar Cd concentrations and gradients in a cereal crop using flux measurements, for the first time. However, the results presented here are only the studies on shoot vacuoles. Investigation of root vacuoles will be much more interesting for future research to unfold the detoxification mechanisms in plants.

Chapter 6

6. Cd mobility within the plant and Cd efflux from roots

6.1 Introduction

In Chapter 2, it was demonstrated that a significant fraction of Cd absorbed by the root was transferred to the shoot. This was in contrast to the Ni results shown in Chapter 3 where very little Ni was transferred. Previous studies on wheat have indicated that Cd is moderately mobile in the phloem. Riesen and Feller (2005) used steam girdling to distinguish between Cd movement in phloem and xylem in wheat ears. They found that steam girdling to block phloem just below the ear reduced grain accumulation by 40% but had no effect on Cd accumulation in vegetative tissues. Uraguchi et al (2009) concluded that Cd is predominantly transferred from root to shoot in the xylem. A related study by Fujimaki et al. (2010) traced Cd movement between xylem and phloem in the shoot nodes, while Uraguchi et al. (2011) characterised a low-affinity transporter that they believed was responsible for the loading of Cd from phloem into the grain. Reid et al. (2003) reported that very little of the Cd that was accumulated by potato tubers came directly from the soil. Instead, Cd absorbed by roots was transported to the shoots, presumably via xylem, and then redirected via the phloem back down to the tubers along with leaf carbohydrates.

In this chapter, I have replicated with ^{109}Cd , the experiment published by Haslett et al. (2001) in which the distribution of ^{65}Zn applied to a single leaf was closely followed over 24 h to gain insight into the main pathways that are involved. This was then compared with the longer term distribution of Cd applied to roots in the nutrient solution.

In Chapter 2, it was established that approximately 10% of Cd absorbed by roots was exported to the shoots. The extent to which Cd can be pumped back out of the root is unknown. In an attempt to quantify efflux, roots were loaded with ^{109}Cd by foliar application, then the appearance of Cd in the solution bathing the roots was quantified.

6.2 Materials and Methods

6.2.1 Cd distribution following uptake through roots

Barley (*Hordeum vulgare* var. Schooner) seeds were germinated on paper towel moistened with deionised water for three days. Following germination, seedlings were grown in 3 L tubs containing 0.2 Hoagland's solution. After one week, two barley seedlings were selected and transferred into 4 L pots containing 0.2 Hoagland's solution with 1 μM ^{109}Cd . These two seedlings were harvested after ten days. The roots were desorbed before harvest in a solution containing 5 mM CaCl_2 and 0.5 mM citric acid adjusted to pH 3.5 with NaOH to remove excess apoplastic metals. The plant parts harvested were: the first leaf (L1), the second leaf (L2), third leaf (L3), Internode (I), and root (R). The leaves of these seedlings were then cut into small segments of 2 cm length and each segment weighed then dried. Each root was cut into four segments and extracted in 10 mM HCl. The radioactivity in the root extracts and shoot samples was determined by liquid scintillation counting.

6.2.2 ^{109}Cd distribution following foliar application

Barley (*Hordeum vulgare* var. Schooner) seeds were germinated on paper towel moistened with deionised water for three days. Following germination, seedlings were grown in 3 L tubs containing 0.2 Hoagland's solution.

After one week, two barley seedlings were selected and transferred into 4 L pots containing only 0.2 Hoagland's solution. After nine days, the second leaf of two plants was selected for the foliar application. The terminal part of the second leaf was encased in a fold of filter paper (approximately 5 cm long), which was then inserted into a 10 ml tube containing 1 μM ^{109}Cd in 0.5 mM CaCl_2 and left for 24 hours. During harvesting, the terminal part of the second leaf was rinsed three times. The plant parts harvested were: the first leaf (L1), the second leaf (L2), third leaf (L3), internode (I), and root (R). The leaves of these seedlings were then cut into small segments of 2 cm length, weighed then placed in labelled scintillation vials and dried for two days. Each root was cut into four segments and extracted in 10 mM HCl. The radioactivity in root and shoot samples was determined by liquid scintillation counting.

6.2.3 Cd efflux from roots

The plant material and plant growth were similar to the foliar application experiment. Four plant seedlings were selected, and each one was transferred to a 500 ml tube with 0.2 Hoagland's nutrient solution. The method of application of ^{109}Cd was the same as that for the foliar distribution experiment described above except that both second and third leaves were used for radio-labelling. After 48 hours, a couple of roots were taken for counting to estimate the starting Cd content of the roots, then the remaining roots, still attached to the plants, were transferred to smaller tubes containing 50 ml of 0.2 Hoagland's solution for the collection of ^{109}Cd that effluxed from the roots over the following 48 hours. Radioactivity in the roots and in the bathing solution was then determined.

6.3 Results

6.3.1 Cd distribution following root uptake

A heatmap showing concentrations of ^{109}Cd in various parts of the barley plant is shown in Fig. 6.1. There was a decreasing trend in the Cd concentration from roots to shoot. The roots accumulated most of the Cd, especially the upper part of the roots. Each root was divided into four segments for analysing the distribution of Cd concentration in the roots. The Cd concentration in the first three upper segments of root was in the range of 1000 - 2000 nmol g⁻¹ FW and Cd concentration then decreased towards the apical portion of the root. The Cd concentration in the root tip portion was in the range of 500 - 1000 nmol g⁻¹. A significant fraction of the root Cd is likely to be due to tightly bound Cd fractions that are not easily removed by desorption.

The translocation of Cd from root to shoot was very low when compared to the root Cd concentration. In shoots, Cd was distributed more to the internode (especially the basal part) and the tip of the youngest leaf, whereas the lowest distribution of Cd was in the first leaf.

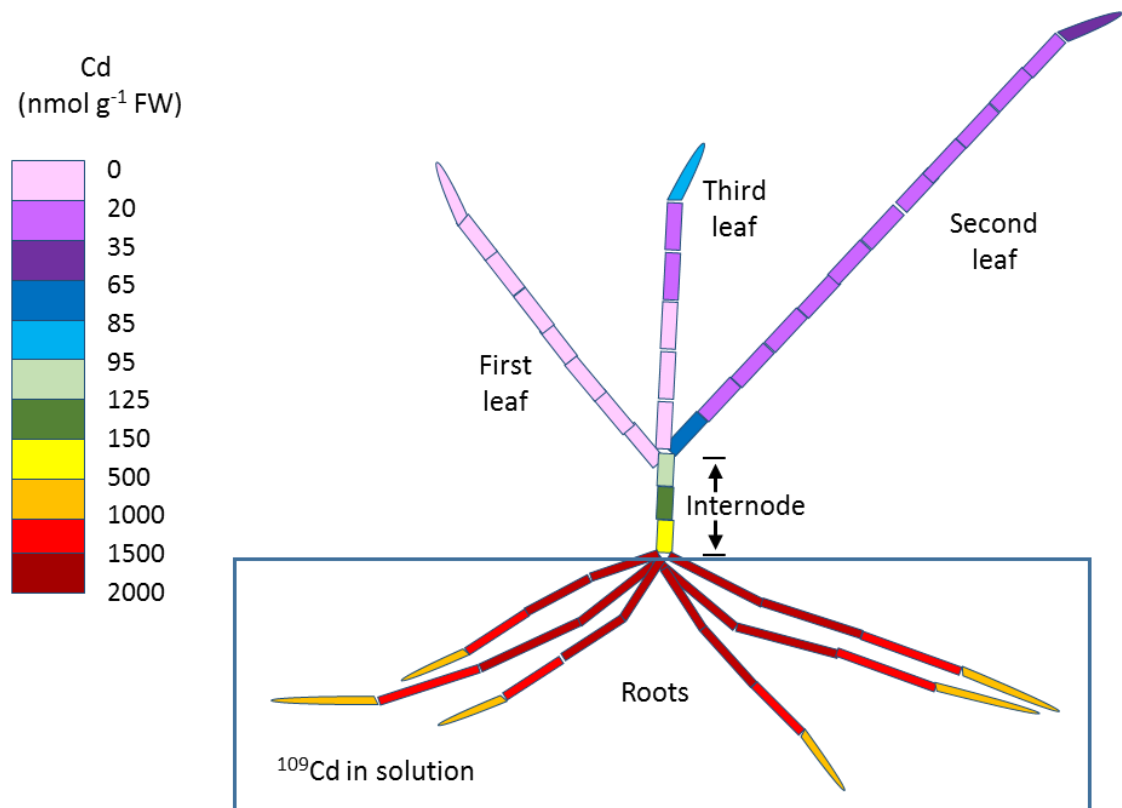

Figure 6.1: Heatmap of the distribution of ¹⁰⁹Cd in 20 d barley seedling, exposed to 1 μ M ¹⁰⁹Cd for the final ten days. The roots were desorbed before harvest.

6.3.2. Cd distribution following foliar application

When applied directly to a leaf tip, Cd was widely distributed over 24 hours. Surprisingly, a large proportion of Cd was distributed to roots instead of shoots. In shoots, Cd was distributed more to the internode and tip of the youngest leaf whereas almost none appeared in the first leaf (Fig. 6.2).

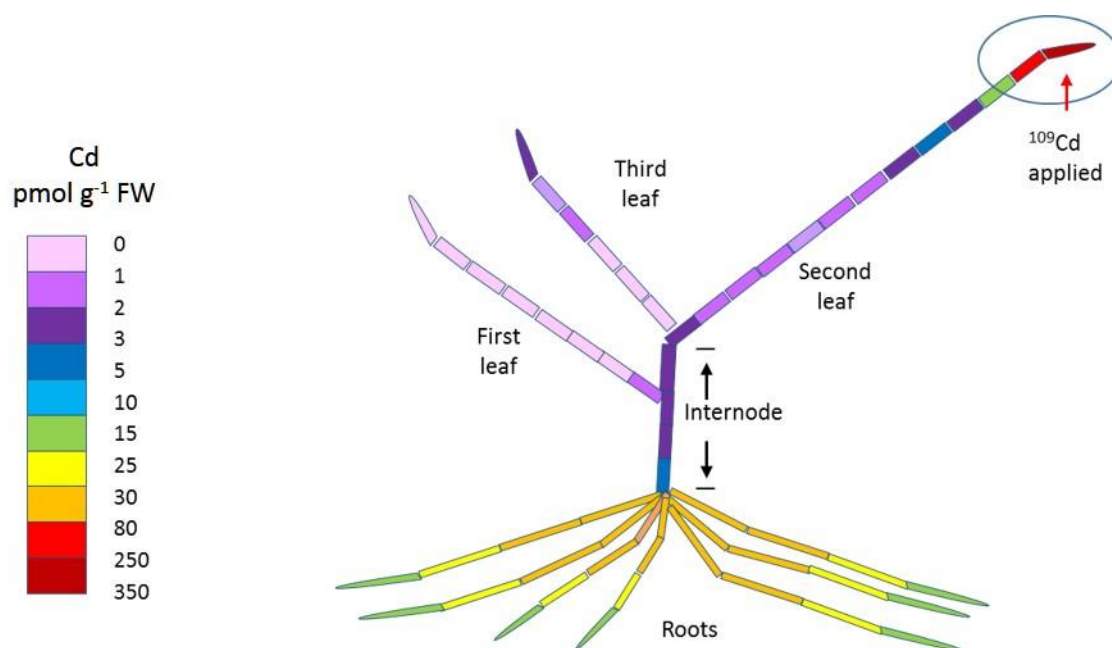

Figure 6.2: Heat map of the distribution of ^{109}Cd in 20 d barley seedling; ^{109}Cd was applied to the surface of the second leaf for 24 hours.

6.3.3 Efflux of Cd from barley roots

The Cd content in roots after 48 hours was 13.2 pmoles per gram FW of root. Coincidentally, the Cd content in the root after 96 h was exactly the same. The total amount of Cd collected in the efflux solution was 1.66 pmoles g^{-1} during the final 48 hours, which represents approximately 12.6% of root Cd (Table 6.2).

Table 6.2 Cd efflux from roots loaded with ^{109}Cd by foliar application

Uptake time	Root Cd content	Total efflux	% efflux	Cd efflux	% efflux/h
h	pmoles g^{-1} FW	pmoles g^{-1} FW		pmol $\text{g}^{-1}\text{h}^{-1}$	
		48 - 96 h	48 - 96 h		
48	13.2 ± 4.5			0.046	
96	13.2 ± 3.3	1.66	12.6	0.035	0.26

6.4 Discussion

The focus of the Cd distribution experiment following foliar application was to understand more about the main pathways that are involved in the distribution of Cd all around the plant. The result of this experiment was compared with longer-term Cd distribution following root uptake. Interestingly, the results reveal that a large proportion of Cd was distributed to roots instead of shoots following foliar application over a short period (24 hours). On the other hand, long-term distribution of Cd applied to roots resulted in a small proportion of Cd in the shoots when compared to the large proportion of Cd in the roots. The movement of ions through xylem is unidirectional, towards the shoot in the transpiration stream. Therefore, the only possibility of downward movement of Cd from the labelled leaf to the roots must be via phloem as Cd is going in the opposite direction to the xylem flow.

In shoots, the results from both types of distribution experiments demonstrated that Cd was distributed more to the internode and tip of the youngest leaf whereas the lowest distribution of Cd was in the first leaf. However, it is rather difficult to find out whether the transfer from the base of the labelled leaf to the upper aerial parts is via xylem or phloem. Similarly, it is quite difficult to determine whether the distribution of Cd in the shoot following root uptake is via xylem or phloem since Cd may be transferred to the phloem at the stem soon after it arrives from the root, or redistributed from leaves, as evidenced by the foliar loading experiment. However, the preferential movement of Cd to the tip of the newest leaf in both cases (Cd distribution following foliar application and Cd distribution following root uptake) implies the involvement of phloem in the distribution of Cd. Some other studies have also suggested the role of phloem in the preferential distribution of Cd towards the newest leaf (Mendoza-Cózatl et al., 2008; Ishikawa et al., 2011; Kobayashi et al., 2013). These findings further support other studies that have shown the involvement of phloem as a major pathway for the long-distance transport of Cd (Cakmak et al., 2000; Dunbar et al., 2003; Reid et al., 2003; Yada, 2004; Mendoza-Cózatl et al., 2008).

The rapid shoot to root transfer of Cd supports the proposal by Van Belleghem et al. (2007) for a role of phloem in the downward transport of Cd from the leaves to the roots as a plant strategy to release Cd from the shoots in *Arabidopsis thaliana*. Other

studies have also suggested the role of phloem in the redistribution of Cd to roots in a low grain Cd-accumulating variety of wheat (Chan and Hale, 2004) and *Brassica lupus* (Mendoza-Cózatl et al., 2008). More research is required to examine whether phloem acts as a pathway for the detoxification of Cd by the transfer of Cd from the shoot to the roots and then back to the soil.

Efflux of Cd from roots and the role of phloem in an excluder strategy

Very little is known about efflux of Cd across the plasma membrane, but presumably this must occur as part of Cd release from root cells, and as part of loading into both phloem and xylem. By loading the roots via application of Cd to leaves, it was possible to gauge the extent of efflux from the roots to the external solution. The results demonstrate that 12.6 % of the amount in the roots was effluxed into the external nutrient solution over 48 hours. A gradual release of 0.26% of Cd from roots per hour seems to be a significant efflux. Some authors have found evidence for Cd efflux and Cd efflux transporters in wheat (Lindberg et al., 2007; Kim et al., 2008) and cucumber (Burzyński et al., 2005). Though exclusion of Cd to the soil was demonstrated in wheat (Page et al., 2006), the present study has provided additional evidence with respect to the efflux rate of Cd from the roots to the soil.

The result of the efflux experiment suggests that Cd that reached the shoot could be returned to the roots via phloem and effluxed back into the soil, as proposed by Page et al. (2006) on the basis of measured root efflux. This could be considered as a tolerance strategy for plants, in addition to complexation in the cytoplasm and compartmentalisation in the vacuole. The current study has only examined the efflux of Cd in barley. Future research should therefore concentrate on the investigation of efflux mechanisms in other plant species to understand more about the different heavy metal tolerance strategies in plants.

It is well known that plant cells walls have a large capacity for binding divalent cations. The presence of a potentially large apoplastic reservoir of Cd in cells of both roots and shoots needs to be considered further in terms of its importance relative to internal compartmentation in cytoplasm and vacuoles.

Chapter 7

7. General Discussion

This dissertation examined the various factors and mechanisms that affect cadmium (Cd) transport in barley (*Hordeum vulgare* cv. Schooner). As Cd is a non-essential metal in plants, the uptake and transport characteristics were compared with those of an essential micronutrient Ni.

It was found that Cd is readily absorbed by roots of barley, and then distributed to aerial parts of the plant. A range of experimental approaches were employed to form an overall picture of how Cd is transported, including cellular uptake and efflux in roots, the potential roles of xylem and phloem in the directional movement into and from various tissues, and the compartmentation of Cd between cytoplasm and vacuoles.

7.1 Uptake and efflux of Cd in roots

Various factors that affect the Cd uptake were investigated in this study and it was found that uptake of Cd can be greatly influenced by other micronutrient cations, both via plant nutrient status and by the competition for uptake. Firstly, Cd uptake was greatly stimulated when plants were deficient in either Fe or Zn. This may occur by the induction of transporters for these metals under deficiency conditions that can also mediate the uptake of Cd. The effects of Fe and Zn deficiencies were seen in both short-term influx and net accumulation but Mn deficiency was found to have no effect on either influx or net accumulation. Secondly, Cd uptake was suppressed by increasing Zn and Fe in the influx solution in nutrient-sufficient plants which indicates that there is competition between these metals for uptake by the transporters that operate under non-deficient conditions. Interestingly, Cd influx was unaffected by FeIII but was inhibited by FeII. Higher concentrations of Mn had no effect on Cd uptake, consistent with the influx and accumulation results at lower concentrations.

Since Cd is a non-essential metal in plants, the transport characteristics of Cd were compared with those of Ni, an essential micronutrient that occurs in soils at

similarly low levels (Chapter 3). Comparison of the root concentrations of Ni and Cd showed that at the same concentration in the nutrient solution (1 μM), more than twice as much Cd was absorbed as Ni, despite plants not needing Cd for growth. The status of other micronutrient cations was found to have a large effect on the uptake of Ni as well, either through nutrient deficiencies or by the competition for uptake. However, Cd influx and Cd net accumulation was approximately two-fold higher than that of Ni in all of the different nutrient conditions.

The finding of a large effect of Fe on the uptake of Ni is quite similar to that of Cd uptake except for the possible interaction between both FeII and FeIII with Ni uptake.

Zn was found to have a strong effect on Ni for uptake, similar to that on Cd uptake. Ni influx was strongly stimulated by Zn starvation, but there was only a small effect on net accumulation. This observation was the exact repetition of what was found in Cd uptake. A likely explanation for this is that in the long term experiment, other micronutrient cations that can suppress Ni or Cd uptake were present in the culture medium, but were absent in the influx measurements in order to see the effect of deficiencies without the complicating effects of competition between micronutrients for uptake. It was shown that FeII, FeIII and Mn strongly suppressed Ni influx, and FeII suppressed Cd uptake, which may lower the long-term uptake of Ni and Cd in Zn-deficient plants.

In contrast to the lack of effect of Mn on the uptake of Cd, Mn was found to have a small effect on the net accumulation of Ni via Mn deficiency but a large effect by competition between Mn and Ni for uptake.

On the whole, the findings of the different hydroponics experiments strongly suggest that the main route for Cd uptake is via Fe and Zn transporters. However, Fe transporters appear to have a greater role in the uptake of Cd than Zn transporters based on the net accumulation results. The inhibition of Cd influx only by FeII (but not by FeIII) would seem to indicate that Cd uptake into the root occurs through divalent cation transporters rather than being mediated by phyto siderophores. Based on current results, the most likely candidates for the transport of Cd across plasma membrane would be IRT1 and NRAMPs. Additionally, the findings also strongly propose that the major route for Ni uptake is also via Fe and Zn transporters; however, the role of Mn transporters in Ni uptake also needs to be considered further.

Uptake of Cd via these transporters is almost certainly by competition between metals for binding to the transporter. There are two important elements to this: the relative affinity for the different metals, and their respective concentrations. Experiments using high concentrations of Cd are unlikely to predict Cd fluxes at concentrations applicable to even highly contaminated agricultural soils, which are at least an order of magnitude lower than the Cd concentration at which toxicity to plant growth is observed. The concentration of Cd used in the current experiments is likely to be at the higher end of the agricultural spectrum (Sauvé et al., 2000) but still below the concentration at which plant growth is affected. However, the comparison between soil solution Cd concentrations and those in nutrient solutions is complicated by the myriad of factors that determine availability in different soils. If the plants were grown under lower Cd concentration in the soil than the amount of Cd used in the current experiments, the competitive effects of these metals are expected to be even greater than shown here.

In addition to the uptake of Cd into the roots, efflux of Cd from roots was also demonstrated in the experiment that examined the root efflux of Cd by loading the roots via application of Cd to leaves (Chapter 6). It was shown that a significant percentage of Cd was effluxed into the external nutrient solution. This must be an active efflux of Cd across the plasma membrane as the Cd ions need to get pumped out against a large inward electrochemical gradient that across the plasma membrane.

7.2 Transfer of Cd to and from the shoot

Nutrient status was found to affect Cd shoot accumulation as well (Chapter 2). Fe deficiency greatly increased net shoot accumulation of Cd, and Zn deficiency elevated shoot Cd, but this large increase may be related to the higher root Cd concentration in the Fe-deficient and Zn-deficient plants.

The transport of Cd to the shoot could be possible through an export into the root xylem. For this export, there must be efflux transporters on the vacuolar membrane and the plasma membrane that can mediate the Cd discharge to the root xylem. It was established in this study that 10% of Cd absorbed by roots was exported to the shoots (Chapter 2). In contrast, the data on Ni in shoots show that almost none of the Ni absorbed by the roots was transported to the shoots (Chapter 3). By comparison, the

proportion of Cd transferred to shoots was much higher. These findings suggest that the Ni absorbed into the roots could be retained in the root vacuoles and the regulation of the transfer of Ni to the shoot could rely on the efflux transporters on the tonoplast. It is likely that the efflux transporters on the tonoplast may not be as discriminative to Cd as to Ni to retain it in the vacuole, which could explain the transfer of a higher proportion of Cd to the shoot when compared to Ni. However, future research is required to unveil more about the mechanisms that restrict the transfer of Ni to the shoot but not Cd at a similar level.

The results presented in Chapter 6 describe a complex pattern of Cd distribution within the plant. The rapid transfer of Cd to shoots seen only 24 hours after addition of Cd to the nutrient solution, appears to suggest that Cd entering the root cytoplasm may be transferred symplastically to the vascular tissue, in parallel with sequestration into root vacuoles. Fujimaki et al.(2010) also demonstrated that Cd was transferred to shoots in a short time after root uptake. However, the results presented here do not provide conclusive evidence that once Cd is transferred into the vacuole, that it can be remobilised. The alternative is that shoot transfer is primarily from the root symplast directly following uptake into the roots.

The rapid downward distribution following foliar application confirms the high mobility of Cd in phloem. The fact that Cd was found to be distributed more to the internode and tip of the youngest leaf and least to the first leaf in both foliar and root application experiments points to a ready exchange between xylem and phloem. It is also difficult to know whether the transfer from the base of the labelled leaf to the upper aerial parts is via xylem or phloem. Similarly, it is quite difficult to determine whether the distribution of Cd in the shoot following root uptake is via xylem or phloem since Cd may be transferred to the phloem at the stem soon after it arrives from the root, or redistributed from leaves, as evidenced by the foliar loading experiment. However, the preferential movement of Cd to the tip of the newest leaf in both cases implies the involvement of phloem in the distribution of Cd. Therefore, this work suggests that Cd that reached in the shoot could be remobilised easily from there and transported to the sink tissues through the phloem. The bidirectional movement of Cd within the plant indicates that Cd is highly mobile in both xylem and phloem.

The findings from the experiment that examined the root efflux of Cd by loading the roots via application of Cd to leaves suggests that Cd that reached the shoot could be returned to the roots via phloem and effluxed back into the soil (Chapter 6). Thus phloem may be an important component in a pathway that excretes Cd from the plant via root efflux. This could be considered as a tolerance strategy for plants, in addition to complexation in the cytoplasm and compartmentalisation in the vacuole. However, the current study has only examined the efflux of Cd in barley. Future research should therefore concentrate on the investigation of efflux mechanisms in other plant species to understand more about the different heavy metal tolerance strategies in plants.

7.3 Uptake of Cd directly into a shoot cell

The response of shoot transporters to factors like nutrient status and cation competition is not clearly understood, mainly because of the difficulty in observing the transport of metals across the plasma membrane of shoot cells directly inside a plant system. Therefore, the different factors affecting the plasma membrane transport processes of Cd and Ni in the shoot were examined directly using protoplasts isolated from the shoot (Chapter 4). The micronutrient status was found to have a significant impact on the uptake of Cd into the shoot protoplasts. However, the findings of the transport studies on protoplasts showed that transporters in the shoot do respond to plant nutrient status but differently to that of the root. Unlike in roots, the Cd influx into shoot protoplasts was inhibited by Zn deficiency but strongly stimulated by Mn deficiency and moderately stimulated by Fe deficiency. On the other hand, only additional Zn inhibited Cd influx into shoot protoplasts in nutrient sufficient plants.

The reason for the inhibitory effect of Zn deficiency on the uptake of Cd in shoot protoplasts is not clear. A curious observation from the shoot net accumulation data (Chapter 2) was that Zn-deficient plants had a 4-fold increase in shoot Fe concentration. However, this cannot be predicted as a hidden reason for the inhibition of the Cd uptake by Zn-deficient plants at this stage. Further research should be done to investigate the reasons for the inhibitory effect of Zn deficiency on the uptake of Cd into the shoot protoplasts.

7.4 Compartmentation of Cd between cytoplasm and vacuoles

The different hydroponic experiments showed that majority of the Cd that entered the plant was located in the roots. This is possible mainly through the retention of Cd in root vacuoles, and partly to apoplastic binding to root cell walls. This research extends our knowledge of the partitioning of cellular Cd between the cytoplasm and the vacuole. In the partitioning studies, it was observed that Cd initially entered the cytoplasm of shoot cells where its concentration gradually increased around 10-fold over the period of one week. The bulk of the cellular Cd was eventually found in the vacuole; after one week, the Cd concentration in the vacuole was 10-fold higher than in the cytoplasm. For this to happen, Cd would have to be actively transported against its electrochemical gradient into the vacuole, which may explain the stimulatory effect of ATP in vacuolar Cd transport. Interestingly, this work has found evidence that Cd is transported both as Cd²⁺ ions and as Cd-GSH complexes. The transport of uncomplexed Cd²⁺ ions into the vacuole must be through divalent cation transporters. Cd influx into vacuoles was stimulated by ATP alone but more strongly stimulated when both ATP and GSH were supplied together. This suggests that Cd entry into vacuoles is mainly as a complex with GSH most likely via ABC-type transporters. Other studies have shown Cd uptake by higher PCs, notably PC2 (Song et al., 2014). However, the results presented here are only studies on shoot vacuoles. Investigation on root vacuoles will be much more interesting for future research to unfold the detoxification mechanisms in plants. Unfortunately, root vacuoles are much more difficult to isolate, especially in quantities needed for transport experiments.

To conclude, the findings of this research point to two strategies for reducing the uptake of Cd into barley plants. The strong effects of Fe and Zn deficiencies on Cd uptake show that proper Fe and Zn nutrition is very important for reducing Cd uptake into the plant. Cd uptake appears to depend on the ratio of Cd: Zn and Cd: Fe in the soil solution, so supplementation with Zn and Fe above the level required for normal nutrition is likely to inhibit Cd uptake. Therefore, these findings recommend that avoidance of Fe and Zn deficiencies and higher Fe/Zn nutrition levels should reduce Cd accumulation.

Bibliography

- Ahmad MSA, Ashraf M** (2012) Essential roles and hazardous effects of nickel in plants. *In* Reviews of environmental contamination and toxicology. Springer, pp 125-167
- Astolfi S, Zuchi S, Neumann G, Cesco S, di Toppi LS, Pinton R** (2012) Response of barley plants to Fe deficiency and Cd contamination as affected by S starvation. *Journal of Experimental Botany* **63**: 1241-1250
- Bao T, Sun L, Sun T, Zhang P, Niu Z** (2009) Iron-deficiency induces cadmium uptake and accumulation in *Solanum nigrum* L. *Bulletin of environmental contamination and toxicology* **82**: 338-342
- Benford D, Ceccatelli S, Cottrill B, DiNovi M, Dogliotti E, Edler L, Farmer P, Fuerst P, Hoogenboom L, Knutsen HK** (2015) Scientific opinion on the risks to public health related to the presence of nickel in food and drinking water. *EFSA Journal* **13**
- Berezin I, Mizrachy-Dagry T, Brook E, Mizrahi K, Elazar M, Zhuo S, Saul-Tcherkas V, Shaul O** (2008) Overexpression of AtMHX in tobacco causes increased sensitivity to Mg, Zn, and Cd ions, induction of V-ATPase expression, and a reduction in plant size. *Plant Cell Reports* **27**: 939-949
- Blumwald E, Gelli A** (1997) Secondary inorganic ion transport at the tonoplast. *Advances in Botanical Research* **25**: 401-417
- Bovet L, Eggmann T, Meylan-Bettex M, Polier J, Kammer P, Marin E, Feller U, Martinoia E** (2003) Transcript levels of AtMRPs after cadmium treatment: induction of AtMRP3. *Plant, Cell & Environment* **26**: 371-381
- Brennan RF, Bolland MDA** (2014) Application of increasing levels of zinc to soil reduced accumulation of cadmium in lupin grain. *Journal of Plant Nutrition* **37**: 147-160
- Brunetti P, Zanella L, De Paolis A, Di Litta D, Cecchetti V, Falasca G, Barbieri M, Altamura MM, Costantino P, Cardarelli M** (2015) Cadmium-inducible expression of the ABC-type transporter AtABCC3 increases phytochelatin-mediated cadmium tolerance in Arabidopsis. *Journal of Experimental Botany* **66**: 3815-3829
- Brown PH, Welch RM, Cary EE** (1987) Nickel: A micronutrient essential for higher plants. *Plant physiology* **85**: 801-803
- Burzyński M, Migocka M, Kłobus G** (2005) Cu and Cd transport in cucumber (*Cucumis sativus* L.) root plasma membranes. *Plant Science* **168**: 1609-1614

- Cakmak I, Welch RM, Erenoglu B, Römheld V, Norvell WA, Kochian LV** (2000) Influence of varied zinc supply on re-translocation of cadmium (^{109}Cd) and rubidium (^{86}Rb) applied on mature leaf of durum wheat seedlings. *Plant and Soil* **219**: 279-284
- Cataldo DA, Garland TR, Wildung RE** (1978) Nickel in plants I. Uptake kinetics using intact soybean seedlings. *Plant physiology* **62**: 563-565
- Chain EPOCitF** (2015) Scientific opinion on the risks to public health related to the presence of nickel in food and drinking water. *EFSA Journal* **13**: 4002
- Chan DY, Hale BA** (2004) Differential accumulation of Cd in durum wheat cultivars: uptake and retranslocation as sources of variation. *Journal of Experimental Botany* **55**: 2571-2579
- Chen A, Komives EA, Schroeder JI** (2006) An improved grafting technique for mature Arabidopsis plants demonstrates long-distance shoot-to-root transport of phytochelatins in Arabidopsis. *Plant physiology* **141**: 108-120
- Chen C, Huang D, Liu J** (2009) Functions and toxicity of nickel in plants: recent advances and future prospects. *CLEAN – Soil, Air, Water* **37**: 304-313
- Chen F, Wu F, Dong J, Vincze E, Zhang G, Wang F, Huang Y, Wei K** (2007) Cadmium translocation and accumulation in developing barley grains. *Planta* **227**
- Chen X-Z, Peng J-B, Cohen A, Nelson H, Nelson N, Hediger MA** (1999) Yeast SMF1 mediates H^+ -coupled iron uptake with concomitant uncoupled cation currents. *Journal of Biological Chemistry* **274**: 35089-35094
- Clemens S** (2001) Molecular mechanisms of plant metal tolerance and homeostasis. *Planta* **212**: 475-486
- Clemens S** (2006) Toxic metal accumulation, responses to exposure and mechanisms of tolerance in plants. *Biochimie* **88**: 1707-1719
- Clemens S, Aarts MG, Thomine S, Verbruggen N** (2013) Plant science: the key to preventing slow cadmium poisoning. *Trends in Plant Science* **18**: 92-99
- Clemens S, Antosiewicz DM, Ward JM, Schachtman DP, Schroeder JI** (1998) The plant cDNA LCT1 mediates the uptake of calcium and cadmium in yeast. *Proceedings of the National Academy of Sciences* **95**: 12043-12048
- Clemens S, Ma JF** (2016) Toxic heavy metal and metalloid accumulation in crop plants and foods. *Annual Review of Plant Biology* **67**: 489-512
- Clemens S, Palmgren MG, Krämer U** (2002) A long way ahead: understanding and engineering plant metal accumulation. *Trends in Plant Science* **7**: 309-315

- Cobbett C, Goldsbrough P** (2002) Phytochelatins and metallothioneins: roles in heavy metal detoxification and homeostasis. *Annual Review of Plant Biology* **53**: 159-182
- Cobbett CS** (2000) Phytochelatins and their roles in heavy metal detoxification. *Plant physiology* **123**: 825-832
- Cohen CK, Fox TC, Garvin DF, Kochian LV** (1998) The role of iron-deficiency stress responses in stimulating heavy-metal transport in plants. *Plant physiology* **116**: 1063-1072
- Colangelo EP, Guerinot ML** (2006) Put the metal to the petal: metal uptake and transport throughout plants. *Current Opinion in Plant Biology* **9**: 322-330
- Conte SS, Walker EL** (2011) Transporters contributing to iron trafficking in plants. *Molecular Plant* **4**: 464-476
- Dassa E, Bouige P** (2001) The ABC of ABCs: a phylogenetic and functional classification of ABC systems in living organisms. *Research in microbiology* **152**: 211-229
- De Brouwere K, Buekers J, Cornelis C, Schlekot CE, Oller AR** (2012) Assessment of indirect human exposure to environmental sources of nickel: oral exposure and risk characterization for systemic effects. *Science of the Total Environment* **419**: 25-36
- Dong WQY, Cui Y, Liu X** (2001) Instances of soil and crop heavy metal contamination in China. *Soil and Sediment Contamination* **10**: 497-510
- Dunbar KR, McLaughlin MJ, Reid RJ** (2003) The uptake and partitioning of cadmium in two cultivars of potato (*Solanum tuberosum* L.). *Journal of Experimental Botany* **54**: 349-354
- Eide D, Broderius M, Fett J, Guerinot ML** (1996) A novel iron-regulated metal transporter from plants identified by functional expression in yeast. *Proceedings of the National Academy of Sciences* **93**: 5624-5628
- Endler A, Reiland S, Gerrits B, Schmidt UG, Baginsky S, Martinoia E** (2009) In vivo phosphorylation sites of barley tonoplast proteins identified by a phosphoproteomic approach. *PROTEOMICS* **9**: 310-321
- Ernst WHO, Krauss G-J, Verkleij JAC, Wesenberg D** (2008) Interaction of heavy metals with the sulphur metabolism in angiosperms from an ecological point of view. *Plant, Cell & Environment* **31**: 123-143
- Eskew DL, Welch RM, Cary EE** (1983) Nickel: an essential micronutrient for legumes and possibly all higher plants. *Science* **222**: 621-623

- Fabiano C, Tezotto T, Favarin JL, Polacco JC, Mazzafera P** (2015) Essentiality of nickel in plants: a role in plant stresses. *Frontiers in plant science* **6**: 754
- Fontanili L, Lancilli C, Suzui N, Dendena B, Yin Y-G, Ferri A, Ishii S, Kawachi N, Lucchini G, Fujimaki S, Sacchi GA, Nocito FF** (2016) Kinetic analysis of zinc/cadmium reciprocal competitions suggests a possible Zn-insensitive pathway for root-to-shoot cadmium translocation in rice. *Rice* **9**: 16
- Fujimaki S, Suzui N, Ishioka NS, Kawachi N, Ito S, Chino M, Nakamura S-i** (2010) Tracing cadmium from culture to spikelet: noninvasive imaging and quantitative characterization of absorption, transport, and accumulation of cadmium in an intact rice plant. *Plant physiology* **152**: 1796-1806
- Gill SS, Tuteja N** (2011) Cadmium stress tolerance in crop plants: probing the role of sulfur. *Plant Signaling & Behavior* **6**: 215
- Gong J-M, Lee DA, Schroeder JI** (2003) Long-distance root-to-shoot transport of phytochelatins and cadmium in Arabidopsis. *Proceedings of the National Academy of Sciences* **100**: 10118-10123
- Goolsby EW, Mason CM** (2015) Toward a more physiologically and evolutionarily relevant definition of metal hyperaccumulation in plants. *Frontiers in plant science* **6**: 33
- Greger M, Kabir AH, Landberg T, Maity PJ, Lindberg S** (2016) Silicate reduces cadmium uptake into cells of wheat. *Environmental Pollution* **211**: 90-97
- Grill E, Löffler S, Winnacker EL, Zenk MH** (1989) Phytochelatins, the heavy-metal-binding peptides of plants, are synthesized from glutathione by a specific γ -glutamylcysteine dipeptidyl transpeptidase (phytochelatin synthase). *Proceedings of the National Academy of Sciences* **86**: 6838
- Grotz N, Fox T, Connolly E, Park W, Guerinot ML, Eide D** (1998) Identification of a family of zinc transporter genes from Arabidopsis that respond to zinc deficiency. *Proceedings of the National Academy of Sciences* **95**: 7220
- Grotz N, Guerinot ML** (2006) Molecular aspects of Cu, Fe and Zn homeostasis in plants. *Biochimica et Biophysica Acta (BBA) - Molecular Cell Research* **1763**: 595-608
- Gunshin H, Mackenzie B, Berger UV, Gunshin Y, Romero MF, Boron WF, Nussberger S, Gollan JL, Hediger MA** (1997) Cloning and characterization of a mammalian proton-coupled metal-ion transporter. *Nature* **388**: 482-488
- Guo J, Dai X, Xu W, Ma M** (2008) Overexpressing GSH1 and AsPCS1 simultaneously increases the tolerance and accumulation of cadmium and arsenic in *Arabidopsis thaliana*. *Chemosphere* **72**: 1020-1026

- Gupta DK, Tohoyama H, Joho M, Inouhe M** (2004) Changes in the levels of phytochelatins and related metal-binding peptides in chickpea seedlings exposed to arsenic and different heavy metal ions. *Journal of plant research* **117**: 253-256
- Gupta V, Jatav PK, Verma R, Kothari SL, Kachhwaha S** (2017) Nickel accumulation and its effect on growth, physiological and biochemical parameters in millets and oats. *Environmental Science and Pollution Research* **24**: 23915-23925
- Hall J** (2002) Cellular mechanisms for heavy metal detoxification and tolerance. *Journal of Experimental Botany* **53**: 1
- Hall J, Williams LE** (2003) Transition metal transporters in plants. *Journal of Experimental Botany* **54**: 2601
- Hanikenne M, Talke IN, Haydon MJ, Lanz C, Nolte A, Motte P, Kroymann J, Weigel D, Krämer U** (2008) Evolution of metal hyperaccumulation required cis-regulatory changes and triplication of HMA4. *Nature* **453**: 391-395
- Hart JJ, Welch RM, Norvell WA, Kochian LV** (2002) Transport interactions between cadmium and zinc in roots of bread and durum wheat seedlings. *Physiologia Plantarum* **116**: 73-78
- Hart JJ, Welch RM, Norvell WA, Kochian LV** (2006) Characterization of cadmium uptake, translocation and storage in near-isogenic lines of durum wheat that differ in grain cadmium concentration. *New Phytologist* **172**: 261-271
- Haslett B, Reid R, Rengel Z** (2001) Zinc mobility in wheat: uptake and distribution of zinc applied to leaves or roots. *Annals of Botany* **87**: 379-386
- Hedrich R, Schroeder JI** (1989) The physiology of ion channels and electrogenic pumps in higher plants. *Annual Review of Plant Biology* **40**: 539-569
- Herbette S, Taconnat L, Hugouvieux V, Piette L, Magniette MLM, Cuine S, Auroy P, Richaud P, Forestier C, Bourguignon J, Renou JP, Vavasseur A, Leonhardt N** (2006) Genome-wide transcriptome profiling of the early cadmium response of Arabidopsis roots and shoots. *Biochimie* **88**: 1751-1765
- Hetherington AM, Brownlee C** (2004) The generation of Ca²⁺ signals in plants. *Annu. Rev. Plant Biol.* **55**: 401-427
- Hussain D, Haydon MJ, Wang Y, Wong E, Sherson SM, Young J, Camakaris J, Harper JF, Cobbett CS** (2004) P-Type ATPase heavy metal transporters with roles in essential zinc homeostasis in Arabidopsis. *The Plant Cell Online* **16**: 1327-1339
- Ishikawa S, Ishimaru Y, Igura M, Kuramata M, Abe T, Senoura T, Hase Y, Arao T, Nishizawa NK, Nakanishi H** (2012) Ion-beam irradiation, gene identification, and

marker-assisted breeding in the development of low-cadmium rice. Proceedings of the National Academy of Sciences **109**: 19166-19171

Ishikawa S, Suzui N, Ito-Tanabata S, Ishii S, Igura M, Abe T, Kuramata M, Kawachi N, Fujimaki S (2011) Real-time imaging and analysis of differences in cadmium dynamics in rice cultivars (*Oryza sativa*) using positron-emitting ¹⁰⁷Cd tracer. BMC Plant Biology **11**: 172

Ishimaru Y, Takahashi R, Bashir K, Shimo H, Senoura T, Sugimoto K, Ono K, Yano M, Ishikawa S, Arai T (2012) Characterizing the role of rice NRAMP5 in manganese, iron and cadmium transport. Scientific reports **2**

Kim Y-Y, Kim D-Y, Shim D, Song W-Y, Lee J, Schroeder JI, Kim S, Moran N, Lee Y (2008) Expression of the novel wheat gene TM20 confers enhanced cadmium tolerance to bakers' yeast. Journal of Biological Chemistry **283**: 15893-15902

Kluge C, Lahr J, Hanitzsch M, Bolte S, Gollack D, Dietz K-J (2003) New insight into the structure and regulation of the plant vacuolar ATPase. Journal of Bioenergetics and Biomembranes **35**: 377-388

Kobayashi NI, Tanoi K, Hirose A, Nakanishi TM (2013) Characterization of rapid intervascular transport of cadmium in rice stem by radioisotope imaging. Journal of Experimental Botany **64**: 507-517

Korenkov V, Hirschi K, Crutchfield J, Wagner G (2007) Enhancing tonoplast Cd/H antiport activity increases Cd, Zn, and Mn tolerance, and impacts root/shoot Cd partitioning *Nicotiana tabacum*; L. Planta **226**: 1379-1387

Korshunova YO, Eide D, Gregg Clark W, Lou Guerinot M, Pakrasi HB (1999) The IRT1 protein from *Arabidopsis thaliana* is a metal transporter with a broad substrate range. Plant Molecular Biology **40**: 37-44

Kramer U, Talke IN, Hanikenne M (2007) Transition metal transport. FEBS letters **581**: 2263-2272

Krishnan S, Dayanandan P (2003) Structural and histochemical studies on grain-filling in the caryopsis of rice (*Oryza sativa* L.). Journal of Biosciences **28**: 455-469

Kudo K, Kudo H, Kawai S (2007) Cadmium uptake in barley affected by iron concentration of the medium: role of phytosiderophores. Soil Science and Plant Nutrition **53**: 259-266

Kutsuna N, Hasezawa S (2005) Morphometrical study of plant vacuolar dynamics in single cells using three-dimensional reconstruction from optical sections. Microscopy Research and Technique **68**: 296-306

- Lavado RS** (2006) Concentration of potentially toxic elements in field crops grown near and far from cities of the Pampas (Argentina). *Journal of environmental management* **80**: 116-119
- Leitenmaier B, Kupper H** (2011) Cadmium uptake and sequestration kinetics in individual leaf cell protoplasts of the Cd/Zn hyperaccumulator *Thlaspi caerulescens*. *Plant, Cell & Environment* **34**: 208-219
- Li H, Luo N, Li YW, Cai QY, Li HY, Mo CH, Wong MH** (2017) Cadmium in rice: transport mechanisms, influencing factors, and minimizing measures. *Environmental Pollution* **224**: 622-630
- Li L, He Z, Pandey GK, Tsuchiya T, Luan S** (2002) Functional cloning and characterization of a plant efflux carrier for multidrug and heavy metal detoxification. *Journal of Biological Chemistry* **277**: 5360-5368
- Lindberg S, Landberg T, Greger M** (2004) A new method to detect cadmium uptake in protoplasts. *Planta* **219**: 526-532
- Lindberg S, Landberg T, Greger M** (2007) Cadmium uptake and interaction with phytochelatins in wheat protoplasts. *Plant Physiology and Biochemistry* **45**: 47-53
- Liu H, Zhao H, Wu L, Liu A, Zhao F-J, Xu W** (2017) Heavy metal ATPase 3 (HMA3) confers cadmium hypertolerance on the cadmium/zinc hyperaccumulator *Sedum plumbizincicola*. *New Phytologist* **215**: 687-698
- Lombi E, Tearall KL, Howarth JR, Zhao F-J, Hawkesford MJ, McGrath SP** (2002) Influence of iron status on cadmium and zinc uptake by different ecotypes of the hyperaccumulator *Thlaspi caerulescens*. *Plant physiology* **128**: 1359-1367
- Luo D, Zheng H, Chen Y, Deleporte P, Xie T, Staunton S, Wang G** (2017) Influence of soil properties on Ni accumulation in food crops and corresponding dietary health risk with a typical Chinese diet. *Soil Use and Management* **33**: 653-662
- Ma JF, Ueno D, Zhao F-J, McGrath SP** (2005) Subcellular localisation of Cd and Zn in the leaves of a Cd-hyperaccumulating ecotype of *Thlaspi caerulescens*. *Planta* **220**: 731-736
- Maeshima M** (2001) Tonoplast transporters: Organization and function. *Annual Review of Plant Physiology and Plant Molecular Biology* **52**: 469-497
- Martinoia E** (2018) Vacuolar transporters—companions on a longtime Journey. *Plant physiology* **176**: 1384-1407
- Martinoia E, Grill E, Tommasini R, Kreuz K, Amrhein N** (1993) ATP-dependent glutathione S-conjugate 'export' pump in the vacuolar membrane of plants. *Nature* **364**: 247-249

- Martinoia E, Maeshima M, Neuhaus HE** (2007) Vacuolar transporters and their essential role in plant metabolism. *Journal of Experimental Botany* **58**: 83-102
- Martinoia E, Massonneau A, Frangne N** (2000) Transport processes of solutes across the vacuolar membrane of higher plants. *Plant and Cell Physiology* **41**: 1175-1186
- Martinoia E, Meyer S, De Angeli A, Nagy R** (2012) Vacuolar transporters in their physiological context. *Annual Review of Plant Biology* **63**: 183-213
- Martinoia E, Ratajczak R** (1997) Transport of organic molecules across the tonoplast. *Advances in Botanical Research* **25**: 365-400
- Marwa EM, Meharg AA, Rice CM** (2012) Risk assessment of potentially toxic elements in agricultural soils and maize tissues from selected districts in Tanzania. *Science of the Total Environment* **416**: 180-186
- McLaughlin MJ, Parker D, Clarke J** (1999) Metals and micronutrients—food safety issues. *Field Crops Research* **60**: 143-163
- Mendoza-Cózatl DG, Butko E, Springer F, Torpey JW, Komives EA, Kehr J, Schroeder JI** (2008) Identification of high levels of phytochelatin, glutathione and cadmium in the phloem sap of *Brassica napus*. A role for thiol-peptides in the long-distance transport of cadmium and the effect of cadmium on iron translocation. *The Plant Journal* **54**: 249-259
- Mendoza-Cózatl DG, Jobe TO, Hauser F, Schroeder JI** (2011) Long-distance transport, vacuolar sequestration, tolerance, and transcriptional responses induced by cadmium and arsenic. *Current Opinion in Plant Biology* **14**: 554-562
- Mendoza-Cózatl DG, Zhai Z, Jobe TO, Akmakjian GZ, Song W-Y, Limbo O, Russell MR, Kozlovskyy VI, Martinoia E, Vatamaniuk OK, Russell P, Schroeder JI** (2010) Tonoplast-localized ABC2 transporter mediates phytochelatin accumulation in vacuoles and confers cadmium tolerance. *Journal of Biological Chemistry* **285**: 40416-40426
- Migeon A, Blaudez D, Wilkins O, Montanini B, Campbell M, Richaud P, Thomine S, Chalot M** (2010) Genome-wide analysis of plant metal transporters, with an emphasis on poplar. *Cellular and Molecular Life Sciences* **67**: 3763-3784
- Mimura T, Dietz KJ, Kaiser W, Schramm MJ, Kaiser G, Heber U** (1990) Phosphate transport across biomembranes and cytosolic phosphate homeostasis in barley leaves. *Planta* **180**: 139-146
- Miyadate H, Adachi S, Hiraizumi A, Tezuka K, Nakazawa N, Kawamoto T, Katou K, Kodama I, Sakurai K, Takahashi H, Satoh-Nagasawa N, Watanabe A, Fujimura T, Akagi H** (2011) OshMA3, a P1B-type of ATPase affects root-to-shoot cadmium

translocation in rice by mediating efflux into vacuoles. *New Phytologist* **189**: 190-199

Morel M, Crouzet J, Gravot A, Auroy P, Leonhardt N, Vavasseur A, Richaud P (2009) AtHMA3, a P1B-ATPase allowing Cd/Zn/Co/Pb vacuolar storage in *Arabidopsis*. *Plant Physiology* **149**: 894

Mori S, Uruguchi S, Ishikawa S, Arao T (2009) Xylem loading process is a critical factor in determining Cd accumulation in the shoots of *Solanum melongena* and *Solanum torvum*. *Environmental and Experimental Botany* **67**: 127-132

Nakanishi H, Ogawa I, Ishimaru Y, Mori S, Nishizawa NK (2006) Iron deficiency enhances cadmium uptake and translocation mediated by the Fe²⁺ transporters OsIRT1 and OsIRT2 in rice. *Soil Science and Plant Nutrition* **52**: 464-469

Nakanishi H, Ogawa I, Ishimaru Y, Mori S, Nishizawa NK (2006) Iron deficiency enhances cadmium uptake and translocation mediated by the Fe²⁺ transporters OsIRT1 and OsIRT2 in rice. *Soil Science and Plant Nutrition* **52**

Neuhaus HE (2007) Transport of primary metabolites across the plant vacuolar membrane. *FEBS letters* **581**: 2223-2226

Nishida S, Kato A, Tsuzuki C, Yoshida J, Mizuno T (2015) Induction of nickel accumulation in response to zinc deficiency in *Arabidopsis thaliana*. *International journal of molecular sciences* **16**: 9420-9430

Nishida S, Tsuzuki C, Kato A, Aisu A, Yoshida J, Mizuno T (2011) AtIRT1, the primary iron uptake transporter in the root, mediates excess nickel accumulation in *Arabidopsis thaliana*. *Plant and Cell Physiology* **52**: 1433-1442

Nolan AL, McLaughlin MJ, Mason SD (2003) Chemical speciation of Zn, Cd, Cu, and Pb in pore waters of agricultural and contaminated soils using Donnan dialysis. *Environmental Science & Technology* **37**: 90-98

Oliver D, Tiller K, Conyers M, Slattery W, Alston A, Merry R (1996) Effectiveness of liming to minimise uptake of cadmium by wheat and barley grain grown in the field. *Australian Journal of Agricultural Research* **47**: 1181-1193

Oparka KJ, Gates P (1984) Sink anatomy in relation to solute movement in rice (*Oryza sativa* L.): A summary of findings. *Plant Growth Regulation* **2**: 297-307

Ortiz D, Kreppel L, Speiser D, Scheel G, McDonald G, Ow DW (1992) Heavy metal tolerance in the fission yeast requires an ATP-binding cassette-type vacuolar membrane transporter. *The EMBO Journal* **11**: 3491

- Ortiz DF, Ruscitti T, McCue KF, Ow DW** (1995) Transport of metal-binding peptides by HMT1, a fission yeast ABC-type vacuolar membrane protein. *Journal of Biological Chemistry* **270**: 4721-4728
- Page V, Bayon R-CL, Feller U** (2006) Partitioning of zinc, cadmium, manganese and cobalt in wheat (*Triticum aestivum*) and lupin (*Lupinus albus*) and further release into the soil. *Environmental and Experimental Botany* **58**: 269-278
- Palmgren MG, Clemens S, Williams LE, Kramer U, Borg S, Schjorring JK, Sanders D** (2008) Zinc biofortification of cereals: problems and solutions. *Trends in Plant Science* **13**: 464-473
- Pandey N, Sharma CP** (2002) Effect of heavy metals Co^{2+} , Ni^{2+} and Cd^{2+} on growth and metabolism of cabbage. *Plant Science* **163**: 753-758
- Park J, Song WY, Ko D, Eom Y, Hansen TH, Schiller M, Lee TG, Martinoia E, Lee Y** (2012) The phytochelatin transporters AtABCC1 and AtABCC2 mediate tolerance to cadmium and mercury. *The Plant Journal* **69**: 278-288
- Pedas P, Schjoerring JK, Husted S** (2009) Identification and characterization of zinc-starvation-induced ZIP transporters from barley roots. *Plant Physiology and Biochemistry* **47**: 377-383
- Pedas P, Ytting CK, Fuglsang AT, Jahn TP, Schjoerring JK, Husted S** (2008) Manganese efficiency in barley: identification and characterization of the metal ion transporter HvIRT1. *Plant physiology* **148**: 455-466
- Perfus Barbeoch L, Leonhardt N, Vavasseur A, Forestier C** (2002) Heavy metal toxicity: cadmium permeates through calcium channels and disturbs the plant water status. *The Plant Journal* **32**: 539-548
- Persans MW, Nieman K, Salt DE** (2001) Functional activity and role of cation-efflux family members in Ni hyperaccumulation in *Thlaspi goesingense*. *Proceedings of the National Academy of Sciences of the United States of America* **98**: 9995-10000
- Pineros MA, Kochian LV** (2003) Differences in whole-cell and single-channel ion currents across the plasma membrane of mesophyll cells from two closely related *Thlaspi* species. *Plant physiology* **131**: 583-594
- Pittman JK** (2005) Managing the manganese: molecular mechanisms of manganese transport and homeostasis. *New Phytologist* **167**: 733-742
- Prévéral S, Gayet L, Moldes C, Hoffmann J, Mounicou S, Gruet A, Reynaud F, Lobinski R, Verbavatz J-M, Vavasseur A** (2009) A common highly conserved cadmium detoxification mechanism from bacteria to humans heavy metal tolerance conferred by the ATP-binding cassette (ABC) transporter SpHMT1 requires

glutathione but not metal-chelating phytochelatin peptides. *Journal of Biological Chemistry* **284**: 4936-4943

Prévéral S, Gayet L, Moldes C, Hoffmann J, Mounicou S, Gruet A, Reynaud F, Lobinski R, Verbavatz J-M, Vavasseur A, Forestier C (2009) A common highly conserved cadmium detoxification mechanism from bacteria to humans. *Journal of Biological Chemistry* **284**: 4936-4943

Raab A, Schat H, Meharg AA, Feldmann J (2005) Uptake, translocation and transformation of arsenate and arsenite in sunflower (*Helianthus annuus*): formation of arsenic-phytochelatin complexes during exposure to high arsenic concentrations. *New Phytologist* **168**: 551-558

Ramesh SA, Shin R, Eide DJ, Schachtman DP (2003) Differential metal selectivity and gene expression of two zinc Transporters from Rice. *Plant Physiology* **133**: 126-134

Ramos I, Esteban E, Lucena JJ, Gárate An (2002) Cadmium uptake and subcellular distribution in plants of *Lactuca* sp. Cd-Mn interaction. *Plant Science* **162**: 761-767

Ratajczak R, Wilkins TA (2000) 7 Energizing the tonoplast. *Vacuolar compartments* **5**: 133

Rauser W, Ackerley C (1987) Localization of cadmium in granules within differentiating and mature root cells. *Canadian Journal of Botany* **65**: 643-646

Rea PA, Sanders D (1987) Tonoplast energization: two H⁺ pumps, one membrane. *Physiologia Plantarum* **71**: 131-141

Rea PA, Vatamaniuk OK, Rigden DJ (2004) Weeds, worms, and more. Papain's long-lost cousin, phytochelatin synthase. *Plant Physiology* **136**: 2463-2474

Reid RJ, Dunbar KR, McLaughlin MJ (2003) Cadmium loading into potato tubers: the roles of the periderm, xylem and phloem. *Plant, Cell & Environment* **26**: 201-206

Riesen O, Feller U (2005) Redistribution of nickel, cobalt, manganese, zinc, and cadmium via the phloem in young and maturing wheat. *Journal of Plant Nutrition* **28**: 421-430

Rizwan M, Mostofa MG, Ahmad MZ, Imtiaz M, Mehmood S, Adeel M, Dai Z, Li Z, Aziz O, Zhang Y (2018) Nitric oxide induces rice tolerance to excessive nickel by regulating nickel uptake, reactive oxygen species detoxification and defense-related gene expression. *Chemosphere* **191**: 23-35

Roberts LA, Pierson AJ, Panaviene Z, Walker EL (2004) Yellow stripe1. Expanded roles for the maize iron-phytosiderophore transporter. *Plant Physiology* **135**: 112

- Rodda MS, Li G, Reid RJ** (2011) The timing of grain Cd accumulation in rice plants: the relative importance of remobilisation within the plant and root Cd uptake post-flowering. *Plant and Soil* **347**: 105-114
- Rodda MS, Reid RJ** (2013) Examination of the role of iron deficiency response in the accumulation of Cd by rice grown in paddy soil with variable irrigation regimes. *Plant and Soil*: **371**: 219-236
- Salt DE, Rauser WE** (1995) MgATP-dependent transport of phytochelatins across the tonoplast of oat roots. *Plant Physiology* **107**: 1293-1301
- Sasaki A, Yamaji N, Ma JF** (2014) Overexpression of OsHMA3 enhances Cd tolerance and expression of Zn transporter genes in rice. *Journal of Experimental Botany* **65**: 6013-6021
- Satoh-Nagasawa N, Mori M, Nakazawa N, Kawamoto T, Nagato Y, Sakurai K, Takahashi H, Watanabe A, Akagi H** (2012) Mutations in rice (*Oryza sativa*) heavy metal ATPase2 (OsHMA2) restrict the translocation of zinc and cadmium. *Plant and Cell Physiology* **53**: 213-224
- Saurin W, Hofnung M, Dassa E** (1999) Getting in or out: early segregation between importers and exporters in the evolution of ATP-binding cassette (ABC) transporters. *Journal of Molecular Evolution* **48**: 22-41
- Sauvé S, Norvell WA, McBride M, Hendershot W** (2000) Speciation and complexation of cadmium in extracted soil solutions. *Environmental Science & Technology* **34**: 291-296
- Schaaf G, Honsbein A, Meda AR, Kirchner S, Wipf D, von Wirén N** (2006) AtIREG2 encodes a tonoplast transport protein involved in iron-dependent nickel detoxification in *Arabidopsis thaliana* roots. *Journal of Biological Chemistry* **281**: 25532-25540
- Schaaf G, Ludewig U, Erenoglu BE, Mori S, Kitahara T, von Wirén N** (2004) ZmYS1 functions as a proton-coupled symporter for phytosiderophore- and nicotianamine-chelated metals. *Journal of Biological Chemistry* **279**: 9091
- Schneider T, Schellenberg M, Meyer S, Keller F, Gehrig P, Riedel K, Lee Y, Eberl L, Martinoia E** (2009) Quantitative detection of changes in the leaf-mesophyll tonoplast proteome in dependency of a cadmium exposure of barley (*Hordeum vulgare* L.) plants. *Proteomics* **9**: 2668-2677
- Schnell Ramos M, Abele R, Nagy R, Suter Grotemeyer M, Tampé R, Rentsch D, Martinoia E** (2011) Characterization of a transport activity for long-chain peptides in barley mesophyll vacuoles. *Journal of Experimental Botany* **62**: 2403

- Semane B, Cuypers A, Smeets K, Van Belleghem F, Horemans N, Schat H, Vangronsveld J** (2007) Cadmium responses in *Arabidopsis thaliana*: glutathione metabolism and antioxidative defence system. *Physiologia Plantarum* **129**: 519-528
- Sghayar S, Ferri A, Lancilli C, Lucchini G, Abruzzese A, Porrini M, Ghnaya T, Nocito FF, Abdelly C, Sacchi GA** (2015) Analysis of cadmium translocation, partitioning and tolerance in six barley (*Hordeum vulgare* L.) cultivars as a function of thiol metabolism. *Biology and Fertility of Soils* **51**: 311-320
- Shao G, Chen M, Wang W, Mou R, Zhang G** (2007) Iron nutrition affects cadmium accumulation and toxicity in rice plants. *Plant Growth Regulation* **53**: 33-42
- Sharma SS, Dietz K-J, Mimura T** (2016) Vacuolar compartmentalization as indispensable component of heavy metal detoxification in plants. *Plant, Cell & Environment* **39**: 1112-1126
- Sharma SS, Kaul S, Metwally A, Goyal KC, Finkemeier I, Dietz K-J** (2004) Cadmium toxicity to barley (*Hordeum vulgare*) as affected by varying Fe nutritional status. *Plant Science* **166**: 1287-1295
- Shenker M, Fan T, Crowley D** (2001) Phytosiderophores influence on cadmium mobilization and uptake by wheat and barley plants. *Journal of Environmental Quality* **30**: 2091-2098
- Song W-Y, Mendoza-CÓZatl DG, Lee Y, Schroeder JI, Ahn S-N, Lee H-S, Wicker T, Martinoia E** (2014) Phytochelatin–metal(loid) transport into vacuoles shows different substrate preferences in barley and *Arabidopsis*. *Plant, Cell & Environment* **37**: 1192-1201
- Song W-Y, Park J, Mendoza-CÓZatl DG, Suter-Grotemeyer M, Shim D, Hörtensteiner S, Geisler M, Weder B, Rea PA, Rentsch D** (2010) Arsenic tolerance in *Arabidopsis* is mediated by two ABCC-type phytochelatin transporters. *Proceedings of the National Academy of Sciences* **107**: 21187-21192
- Sooksa-nguan T, Yakubov B, Kozlovskyy VI, Barkume CM, Howe KJ, Thannhauser TW, Rutzke MA, Hart JJ, Kochian LV, Rea PA, Vatamaniuk OK** (2009) *Drosophila* ABC transporter, DmHMT-1, confers tolerance to cadmium. *Journal of Biological Chemistry* **284**: 354-362
- Srekanth T, Nagajyothi P, Lee K, Prasad T** (2013) Occurrence, physiological responses and toxicity of nickel in plants. *International Journal of Environmental Science and Technology* **10**: 1129-1140
- Su Y, Wang X, Liu C, Shi G** (2013) Variation in cadmium accumulation and translocation among peanut cultivars as affected by iron deficiency. *Plant and Soil* **363**: 201-213

- Sze H, Li X, Palmgren MG** (1999) Energization of plant cell membranes by H⁺-Pumping ATPases: regulation and biosynthesis. *The Plant Cell Online* **11**: 677-690
- Takahashi R, Ishimaru Y, Senoura T, Shimo H, Ishikawa S, Arao T, Nakanishi H, Nishizawa NK** (2011) The OsNRAMP1 iron transporter is involved in Cd accumulation in rice. *Journal of Experimental Botany* **62**: 4843-4850
- Takahashi R, Ishimaru Y, Shimo H, Ogo Y, Senoura T, Nishizawa NK, Nakanishi H** (2012) The OsHMA2 transporter is involved in root-to-shoot translocation of Zn and Cd in rice. *Plant, Cell & Environment* **35**: 1948-1957
- Tanaka K, Fujimaki S, Fujiwara T, Yoneyama T, Hayashi H** (2007) Quantitative estimation of the contribution of the phloem in cadmium transport to grains in rice plants (*Oryza sativa* L.). *Soil Science and Plant Nutrition* **53**: 72-77
- Tavakoli N, Kluge C, Gollack D, Mimura T, Dietz K-J** (2001) Reversible redox control of plant vacuolar H⁺-ATPase activity is related to disulfide bridge formation in subunit E as well as subunit A. *The Plant Journal* **28**: 51-59
- Thomine S, Wang R, Ward JM, Crawford NM, Schroeder JI** (2000) Cadmium and iron transport by members of a plant metal transporter family in Arabidopsis with homology to Nramp genes. *Proceedings of the National Academy of Sciences* **97**: 4991-4996
- Ueno D, Milner MJ, Yamaji N, Yokosho K, Koyama E, Clemencia Zambrano M, Kaskie M, Ebbs S, Kochian LV, Ma JF** (2011) Elevated expression of TcHMA3 plays a key role in the extreme Cd tolerance in a Cd-hyperaccumulating ecotype of *Thlaspi caerulescens*. *The Plant Journal* **66**: 852-862
- Ueno D, Yamaji N, Kono I, Huang CF, Ando T, Yano M, Ma JF** (2010) Gene limiting cadmium accumulation in rice. *Proceedings of the National Academy of Sciences* **107**: 16500-16505
- Uraguchi S, Fujiwara T** (2012) Cadmium transport and tolerance in rice: perspectives for reducing grain cadmium accumulation. *Rice* **5**: 1-8
- Uraguchi S, Kamiya T, Sakamoto T, Kasai K, Sato Y, Nagamura Y, Yoshida A, Kyojuka J, Ishikawa S, Fujiwara T** (2011) Low-affinity cation transporter (OsLCT1) regulates cadmium transport into rice grains. *Proceedings of the National Academy of Sciences* **108**: 20959-20964
- Uraguchi S, Mori S, Kuramata M, Kawasaki A, Arao T, Ishikawa S** (2009) Root-to-shoot Cd translocation via the xylem is the major process determining shoot and grain cadmium accumulation in rice. *Journal of Experimental Botany* **60**: 2677-2688

- Van Belleghem F, Cuypers A, Semane B, Smeets K, Vangronsveld J, D'Haen J, Valcke R** (2007) Subcellular localization of cadmium in roots and leaves of *Arabidopsis thaliana*. *New Phytologist* **173**: 495-508
- Vázquez MD, Barceló J, Poschenrieder C, Mádico J, Hatton P, Baker AJM, Cope GH** (1992) Localization of zinc and cadmium in *Thlaspi caerulescens* (Brassicaceae), a metallophyte that can hyperaccumulate both metals. *Journal of Plant Physiology* **140**: 350-355
- Verbruggen N, Hermans C, Schat H** (2009) Mechanisms to cope with arsenic or cadmium excess in plants. *Current Opinion in Plant Biology* **12**: 364-372
- Verret F, Gravot A, Auroy P, Leonhardt N, David P, Nussaume L, Vavasseur A, Richaud P** (2004) Overexpression of AtHMA4 enhances root-to-shoot translocation of zinc and cadmium and plant metal tolerance. *FEBS Letters* **576**: 306-312
- Vert G, Grotz N, Dédaldéchamp F, Gaymard F, Guerinot ML, Briat J-F, Curie C** (2002) IRT1, an *Arabidopsis* transporter essential for iron uptake from the soil and for plant growth. *The Plant Cell Online* **14**: 1223-1233
- Vögel-Lange R, Wagner GJ** (1990) Subcellular localization of cadmium and cadmium-binding peptides in tobacco leaves: implication of a transport function for cadmium-binding peptides. *Plant Physiology* **92**: 1086-1093
- Wang S, Nan Z, Liu X, Li Y, Qin S, Ding H** (2009) Accumulation and bioavailability of copper and nickel in wheat plants grown in contaminated soils from the oasis, northwest China. *Geoderma* **152**: 290-295
- White P, Pineros M, Tester M, Ridout M** (2000) Cation permeability and selectivity of a root plasma membrane calcium channel. *Journal of Membrane Biology* **174**: 71-83
- Williams LE, Pittman JK, Hall JL** (2000) Emerging mechanisms for heavy metal transport in plants. *Biochimica et Biophysica Acta (BBA) - Biomembranes* **1465**: 104-126
- Wintz H, Fox T, Wu YY, Feng V, Chen W, Chang HS, Zhu T, Vulpe C** (2003) Expression profiles of *Arabidopsis thaliana* in mineral deficiencies reveal novel transporters involved in metal homeostasis. *Journal of Biological Chemistry* **278**: 47644-47653
- Wójcik M, Vangronsveld J, D'Haen J, Tukiendorf A** (2005) Cadmium tolerance in *Thlaspi caerulescens*: II. Localization of cadmium in *Thlaspi caerulescens*. *Environmental and Experimental Botany* **53**: 163-171
- Wong CKE, Cobbett CS** (2009) HMA P-type ATPases are the major mechanism for root-to-shoot Cd translocation in *Arabidopsis thaliana*. *New Phytologist* **181**: 71-78

- Wu F, Zhang G, Yu J** (2003) Interaction of cadmium and four microelements for uptake and translocation in different barley genotypes. *Communications in Soil Science and Plant Analysis* **34**: 2003-2020
- Wu Z, Zhao X, Sun X, Tan Q, Tang Y, Nie Z, Hu C** (2015) Xylem transport and gene expression play decisive roles in cadmium accumulation in shoots of two oilseed rape cultivars (*Brassica napus*). *Chemosphere* **119**: 1217-1223
- Xu Q, Wang C, Li S, Li B, Li Q, Chen G, Chen W, Wang F** (2017) Cadmium adsorption, chelation and compartmentalization limit root-to-shoot translocation of cadmium in rice (*Oryza sativa* L.). *Environmental Science and Pollution Research* **24**: 11319-11330
- Yada S** (2004) Uptake and transport of Cd supplied at early growth stage in hydroponically cultured soybean plants. *Biomedical Research on Trace Elements* **15**: 292-294
- Yamaji N, Ma JF** (2014) The node, a hub for mineral nutrient distribution in graminaceous plants. *Trends in Plant Science* **19**: 556-563
- Yoneyama T, Gosho T, Kato M, Goto S, Hayashi H** (2010) Xylem and phloem transport of Cd, Zn and Fe into the grains of rice plants (*Oryza sativa* L.) grown in continuously flooded Cd-contaminated soil. *Soil Science and Plant Nutrition* **56**: 445-453
- Zarcinas BA, Pongsakul P, McLaughlin MJ, Cozens G** (2004) Heavy metals in soils and crops in Southeast Asia 2. Thailand. *Environmental geochemistry and health* **26**: 359-371
- Zee S-Y** (1972) Vascular tissue and transfer cell distribution in the rice spikelet. *Australian Journal of Biological Sciences* **25**: 411-414
- Zenk MH** (1996) Heavy metal detoxification in higher plants-a review. *Gene* **179**: 21-30
- Zhang J, Martinoia E, Lee Y** (2018) Vacuolar transporters for cadmium and arsenic in plants and their applications in phytoremediation and crop development. *Plant and Cell Physiology* **59**: 1317-1325
- Zhang J, Zhang M, Shohag MJI, Tian S, Song H, Feng Y, Yang X** (2016) Enhanced expression of SaHMA3 plays critical roles in Cd hyperaccumulation and hypertolerance in Cd hyperaccumulator *Sedum alfredii* Hance. *Planta* **243**: 577-589