

20.6.78

INTRA-URBAN MIGRATION IN THE ADELAIDE
METROPOLITAN AREA: A SPATIAL ANALYSIS
OF SUBURBAN POPULATIONS

by

BRIAN J. WARD, B.A.(HONS), Dip.Ed.

Department of Geography,

University of Adelaide

Thesis submitted for the degree of Master of Arts,
through the Department of Geography,
The University of Adelaide, South Australia,
December, 1975.

What is the city, but the people?

WILLIAM SHAKESPEARE

The Tragedy of Coriolanus.

Act III, Sc.I, line 198

Code No.	Subdivision	Code No.	Subdivision
71	ADELAIDE	78	HINDMARSH
711	Adelaide	781	Beverley
712	Florey West	782	Hanson North
713	Gilles West	783	Henley Beach
714	Ross Smith	784	Peake
715	St. Peters	785	Spence South
716	Torrens	786	Thebarton
72	ANGAS [part]	79	KINGSTON
722	Fisher East	791	Brighton
724	Heysen North [part] ¹	792	Glenelg
		793	Hanson South
		794	Mawson
73	BARKER [part]	80	PORT ADELAIDE
730	Alexandra [part] ²	801	Albert Park
731	Fisher South	802	Angle Park
732	Flagstaff Hill	803	Price
736	Moana	804	Semaphore
		805	Spence North
74	BONYTHON	81	STURT
741	Elizabeth	811	Coles
742	Florey East	812	Davenport
743	Modbury North	813	Gilles East
744	Playford	814	Highbury
745	Salisbury		
75	BOOTHBY	82	WAKEFIELD [part]
751	Bragg	823	Goyder [part] ³
752	Fisher North	824	Light North [part] ⁴
753	Leabrook		
754	Mitcham		
755	Norwood		
756	Unley		
77	HAWKER		
771	Ascot Park		
772	Fisher West		
773	Goodwood		
774	Hanson East		
775	Marleston		
776	Mitchell		

- ¹ Postcodes: 5066/5134/5136/
5137/5138/5139/5140/5141/
5142/5144/5150/5151/5152/
5153/5154
- ² Postcodes: 5157/5168/5170/
5171/5172/5173/5174
- ³ Postcodes: 5110/5117/5120
- ⁴ Postcodes: 5116/5118

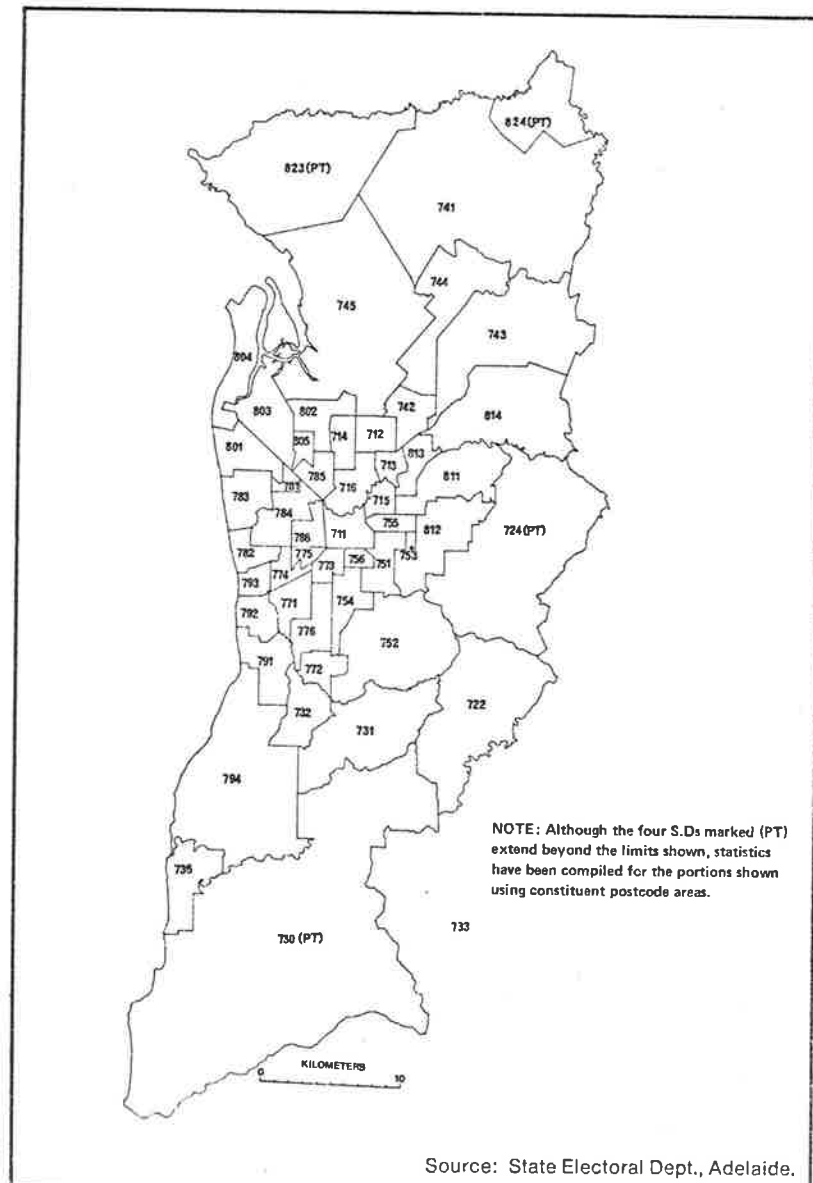

KEY TO CODE NUMBERS, NAMES AND LOCATION
OF ELECTORAL SUBDIVISIONS

Key to names and computer code numbers of electoral subdivisions
(S.D.s) within the Adelaide Statistical Division (A.S.D.) March, 1970.

TABLE OF CONTENTS

	Page
List of Figures	x
List of Tables	xvi
Acknowledgements	xxiv
I: INTRA-URBAN MIGRATION IN THE BROADER CONTEXT OF POPULATION AND MOVEMENT STUDIES	1
Outline	1
1.1 Introduction	4
1.2 The Definitions and Classification of Population Movements	5
1.3 Migration Studies in General and Urban Contexts	11
1.3.1 Examples of Descriptive Studies	15
1.3.2 Examples of Explanatory Studies	16
1.3.3 Examples of Predictive Studies	19
1.4 Models and Levels of Generalization	19
1.5 This Study	23
References	25
2: THIS PRESENT STUDY - AIMS AND IMPLEMENTATION	31
Outline	31
2.1 Aims and Objectives	34
2.1.1 Summary of Major Intent	34
2.1.2 Specific Questions for Investigation	34
2.1.3 Some Possible Outcomes	35
2.2 The Whole City as a Unit of Study	35
2.2.1 To Sample or Not to Sample	37
2.2.2 The Selection of an Outer Boundary	41
2.3 Sources of Data	42
2.4 Outline of Uses Made of the Data - an Overview of the Thesis	48
2.4.1 Indirect Evidence of Population Movement (Chapter 3)	48

	Page.	
2.4.2	Movement Indices, Active Links and Mover-Stayer Analysis (Chapter 4)	49
2.4.3	The City as a Matrix - Flows, Linkages and Volumes (Chapter 5)	50
2.4.4	Distances of Outmovement (Chapter 6)	50
2.4.5	Directions of Outmovement (Chapter 7)	51
2.4.6	Comparison of Selected Population Characteristics and Movement Parameters (Chapter 8)	51
2.4.7	A Note on the Use of Correlation Coefficients in this Study	52
	References	57
3:	INDIRECT EVIDENCE OF POPULATION MOVEMENT - GROSS AND NET CHANGES	61
	Outline	61
3.1	Introduction	69
3.2	Analysis by Local Government Areas	71
3.2.1	1961 to 1966	71
3.2.1.1	Total population change	72
3.2.1.2	Natural increase	73
3.2.1.3	Net migration	74
3.2.2	Comparison of Intercensal Population Changes, 1961-66 and 1966-71	76
3.2.2.1	General comparisons	76
3.2.2.2	Population change	76
3.2.2.3	Natural increase	77
3.2.2.4	Net migration	77
3.2.2.5	Summary	77
3.3	Comparison of Population Changes by Census C.D.s and L.G.A.s 1961-1966	79
3.3.1	Within L.G.A.s of Highest Growth Rate	80
3.3.2	Within L.G.A.s of Less Than Average Growth	80
3.4	Some Further Questions	82
3.4.1	The Need for Another Source of Data	83
3.5	Comparison of Data from L.G.A.s, C.D.s and Electoral S.D.s	86
3.5.1	Areas of Underestimate (Negative) by the Electoral Rolls	88
3.5.2	Areas of Overestimate (Positive) by the Electoral Rolls	90

	Page
3.5.3 Areas of General Agreement on Population Change	91
3.6 Percentage of Eligibles in the Population who are on the Electoral Roll	93
3.6.1 Search for Estimate of Error	95
3.6.2 In-Visitors as Inflaters of Population Numbers	96
3.6.3 Out-Visitors as Depletors of Eligible Population Numbers	96
3.6.4 Influence of Split Census Collector's Districts	98
3.7 Features of Electoral Registration in South Australia	100
3.7.1 Categories of Electors	101
3.7.2 Problem of "Time-lag"	102
3.7.3 Electoral Units	103
3.8 Computer Handling of South Australian Rolls	105
3.8.1 Maintaining Electoral Rolls	106
3.8.2 Cumulative Lists	107
3.9 Categories of Deletions	110
3.9.1 Distribution of all Deletions	111
3.9.2 Summary of all Categories of Deletions	111
3.9.3 Categories of Deletions	113
3.10 Summary	115
References	118
4: DIRECT EVIDENCE OF POPULATION MOVEMENT	121
Outline	121
4.1 Introduction	126
4.2 Mover-stayer Analysis	127
4.3 Indices of Movement	130
4.3.1 Net Migration Index	130
4.3.2 Population Turnover Index	133
4.3.3 Comparison of Movement Indices with Percentage Eligibles on the Roll	138
4.4 Movers/Outmigrants	141
4.4.1 Outline	141
4.4.2 Relative Importance of Donor Areas	141
4.4.3 Comparison of Outmigration to Areas Within and Without Adelaide Statistical Division	141

	Page	
4.5	Active Links	145
4.6	Centroids	148
	4.6.1 The Need for Points in a Network	148
	4.6.2 Determination of Centroids	159
4.7	Summary	152
	References	154
5:	THE CITY AS A MATRIX: FLOWS, LINKAGES AND VOLUMES OF RESIDENTIAL MOVEMENT	156
	Outline	156
5.1	Introduction - The Matrix	161
5.2	Flows	163
	5.2.1 An Overview	163
	5.2.2 Selected Examples of Individual Origin Areas	169
	5.2.3 Largest Flows	174
5.3	Internal Moves	178
	References	180
6:	DISTANCES OF OUTMOVEMENT	182
	Outline	182
6.1	Introduction	186
6.2	The Data And Methods Of Analysis Of Distance Moved	187
	6.2.1 Between Subdivisions	187
	6.2.2 Within Each Subdivision	188
	6.2.2.1 Problem	188
	6.2.2.2 Available information	190
	6.2.2.3 Method for internal distance determination	192

	Page	
6.3	Distribution of Distance Moved	195
6.3.1	All moves considered in aggregate: a model	196
6.3.2	Modelling results considered	199
6.3.3	Internal moves	200.1
6.4	Distance Moved Compared With Other Variables	200.2
6.4.1	Size of S.D. and distance	200.4
6.4.2	Movement indices and distance	200.6
6.4.3	Rate of fall-off with distance of origin from C.B.D.	200.8
6.4.4	Ethnicity	200.9
6.4.5	Forced moves	200.10
6.5	Summary	200.10
	References	200.12
7:	DIRECTIONS OF OUTMOVEMENT	201
	Outline	201
7.1	Introduction	206
7.2	Some Previous Studies	206

	Page	
7.3	Analysis of Circular Distributions	211
	7.3.1 Some General Problems	211
	7.3.2 Background to the Special Technique	214
	7.3.3 Special Technique	217
	7.3.4 Index of Concentration	220
7.4	The Case Study	222
	7.4.1 The Data and Some General Impressions	222
	7.4.2 Dominant Direction of Outmovement	227
	7.4.3 Index of Directional Concentration of Outmovement	236
7.5	Summary and Conclusions	239
	References	242
8:	COMPARISON OF SELECTED POPULATION CHARACTERISTICS AND MOVEMENT PARAMETERS	246
	Outline	246
8.1	Introduction	252
	8.1.1 Background	252
	8.1.2 Aim of this Chapter	253
8.2	Search for an Analytical Procedure (Using Correlation Coefficients)	255
	8.2.1 Social Area Analysis or Factorial Ecology	255
	8.2.2 Selection of Variables	261
	8.2.3 Definition of Selected Variables	264
8.3	Linkage Analysis	268
	8.3.1 Steps in Derivation of First Generation Linkages	269
	8.3.2 Steps in Derivation of Second Generation Linkages	269
8.4	Comparison of Three Australian Correlation Studies of Population Turnover	272
	8.4.1 Population Turnover	274
	8.4.2 Other Variables	276
	8.4.3 Summary	280
8.5	Partial Correlation Analysis	280
	8.5.1 Shortcomings of Simple Correlation Analysis	280

	Page
8.5.2 Application of Partial Correlation	283
8.5.3 Population Turnover	283
8.5.4 Net Migration	285
8.6 Multiple Regression	287
8.6.1 Population Turnover	288
8.6.2 Net Migration	289
8.7 Chapter Eight Summary and Conclusions	291
8.8 Thesis Summary and Conclusions	293
8.8.1 Major Intent and Findings	294
8.8.2 Implications for Further Research	297
8.8.3 Summary Evaluation	301
References	303
APPENDIX A Maps showing the distribution among the fifty electoral subdivisions within the Adelaide Statistical Division of 28 selected indices of population, housing and geometric measures.	312
APPENDIX B Population age pyramids for the whole Adelaide Statistical Division and each of its fifty electoral subdivisions	330
APPENDIX C Graphs for the whole Adelaide Statistical Division and each of its fifty electoral subdivisions showing the age structure of the total population and Coulson's Age Structure Index	345
APPENDIX D Polar graphs for each electoral subdivision within the Adelaide Statistical Division showing the volume, distance and direction of intra-urban migrations	360
APPENDIX E Calculated distances (km) from every centroid to every other centroid	370
APPENDIX F Direction in degrees from every centroid to every other centroid with reference to north	374
APPENDIX G Direction in degrees from every centroid to every other centroid with reference to the C.B.D.	378
APPENDIX H Summary cross tabulation showing number of electoral out-transfers by distance and direction with reference to the C.B.D.	382

	Page
APPENDIX I	
Summary cross tabulation showing number of electoral out-transfers by distance and direction with reference to north	387
BIBLIOGRAPHY	392

LIST OF FIGURES

Figure	Page
1.1 A classification of human movement	7
1.2 A three-dimensional classification of studies in human movement	14
2.1 Location of study area	facing p. 34
2.2 The study area: Adelaide Statistical Division	facing p. 42
3.1 Percentage population changes in Local Government Areas, 1961-1966 Population change Natural increase Net migration	facing p. 70
3.2 Concentric zonation of Local Government areas in the Adelaide Statistical Division for discussion purposes	facing p. 72
3.3 Comparison of L.G.A. rankings on rates of natural increase and net migration 1961-1966 1961-66 and 1966-71	facing p. 74
3.4 Percentage population changes in Local Government Areas, 1966-71 population change natural increase net migration	facing p. 76
3.5 Comparison of boundaries of Local Government Areas and electoral subdivision	facing p. 85
3.6 Relationships between spatial units used in this study in analysis of population movement	facing p. 86
3.7 Mean annual rate of net population change in electoral subdivisions, 1966-1971	facing p. 87
3.8 Mean annual rate of net change in number of electors in electoral subdivisions, 1970-71	facing p. 87
3.9 (1) Relative ranking of growth in electoral subdivisions measured by census and electoral rolls (2) Frequency of ranking deviations of electoral change compared with census change	facing p. 88

Figure	Page
3.10 Ranking deviations of electoral change compared with intercensal change	under p. 88
3.11 (1) Annual rate of naturalization in Local Government Areas, 1970-71 (2) Percentage of adult aliens in adult populations of electoral subdivisions, 1971	facing p. 90
3.12 Percentage of electors in total population in electoral subdivision, 1971	facing p. 92
3.13 Comparison of spatial distributions of (1) percentage of eligible persons registered on electoral rolls, (2) percentage after adjustment to minimize anomalies, (3) number of fragmented census collector's districts	facing p. 94
3.14 Effect of "adjustment" on percentage of eligibles on electoral subdivision rolls	under p. 94
3.15 Flow within electoral offices of information lodged by members of the general public	facing p. 100
3.16 Electoral divisions, districts and subdivisions, Adelaide Statistical Division, 1970	facing p. 104
3.17 Classes of transactions made in the maintenance of S.A. composite electoral rolls	facing p. 107
3.18 (1) Deletions percentage of mean electoral population deleted 12/3/70 to 11/6/71 (2) Deletions (all categories) ranked by absolute scores (3) Transfers as a percentage of all deletions (4) Objections as a percentage of all deletions	facing p. 111
3.19 Each subdivision, percentage of categories of deletions from electoral rolls, 11/3/70 to 11/6/71	facing p. 112
3.20 Graphs showing for each subdivision and for each category of deletion the percentage of all deletions which are transfers, interstate, deceased, objections or miscellaneous	under p. 113

Figure	Page	
3.21	Maps showing	
	(1) Interstate moves as a percentage of all deletions	
	(2) Deceased as percentage of all deletions	
	(3) Miscellaneous as percentage of all deletions	facing p. 113
3.22	Summary of population groups discussed and correlations between them	116
4.1	Mover-stayer analysis. Comparison of data derived from census and electoral rolls by electoral subdivision:	
	(1) absolute numbers of stayers,	
	(2) percentage mean annual stayers,	
	(3) absolute numbers of movers,	
	(4) percentage mean annual movers	under p. 128
4.2	Comparison of mean annual percentage of stayers derived from (1) electoral data (2) census data and (3) ranking deviations	facing p. 129
4.3	(Index NM) Percentage annual net migration of electors, 1970-71	facing p. 132
4.4	(Index PT) Percentage annual population turnover of electors, 1970-71	facing p. 134
4.5	Comparison of percentage annual rates of net migration and population turnover for Adelaide Electoral Subdivisions	under p. 134
4.6	Cross classification of electoral subdivisions on annual rates of net migration and population turnover	under p. 135
4.7	Topological map of annual population turnover 1970-71, Electoral Subdivisions	facing p. 138
4.8	Relationship between population indices and percentage of eligibles (unadjusted and adjusted) on electoral rolls	under p. 138
4.9	Total electoral transfers from subdivisions 1970-71.	
	(1) Rank order	
	(2) Size distribution	facing p. 141

Figure	Page	
4.10	Out-transfers of electors from electoral subdivisions, Adelaide Statistical Division 1970-71:	
	(1) Percentage of electoral transfers to destinations within Adelaide Statistical Division	
	(2) Subdivisions ranked by total outflow to Adelaide Statistical Division (CITY to CITY)	
	(3) Subdivisions ranked by total outflow to areas outside Adelaide Statistical Division (CITY to RURAL)	facing p.142
4.11	Cumulative frequencies of active links and individual moves,	
	(1) Cumulative frequency of active links utilized by origin subdivision,	
	(2) Comparison of cumulative percentages by volume of connecting flow for active links and individual moves	facing p.146
4.12	Electoral subdivisions ranked as origins by number of active links (destinations) used by transfers	under p.146
4.13	Location of calculated population centroids in Electoral Subdivisions, 1971	facing p.151
5.1	Three largest flows from each electoral subdivision in the Adelaide Statistical Division	facing p.163
5.1/A	Diagrams showing for a selection of areas the chain of relationships by first and second order flows of residential transfers	167
5.2	Outmoves from a selection of electoral subdivisions in the Adelaide Statistical Division, 12 March 1970 to 11 June 1971:	
	(1) Graphs showing percentage cumulative frequency of outmoves by number of active links in rank size order	
	(2) Maps showing comparative spatial arrangement of outmoves	under p.169
5.3	The largest 110 flows from electoral subdivisions, Adelaide Statistical Division	facing p.174
6.1	Graph comparing percentage cumulative frequencies for distance moved in each of four stages of the distance-moved model	facing p.196
6.2	(Map) Mean distance of outmoves from each electoral subdivision	facing p.200

Figure	Page
6.3 Distances moved by electors on residential transfer (1970-71)	
(1) Mean number of moves per active link by distance moved	
(2) The four stages of the distance-moved model, showing the percentage of transfers against distance moved	facing p.199
6.4 Distance of C.B.D. from each origin subdivision compared with	
(1) rate of fall-off in number of moves with distance	
(2) mean distance moved	facing p.200.8
6.5 Pearson correlation coefficients between mean distance moved and selected variables	200.6
7.1 Allocation of cosine values to directional classes in calculation of Dominant Direction of Outmovement	facing p.218
7.2 Graphs for selected subdivisions showing numbers and directions of intra-urban out-migrations	facing p.223
7.3 Diagrams for selected subdivisions showing volume, distance and direction of intra-urban migrations	under p.223
7.4 Composite diagram of Adelaide Statistical Division showing for each electoral subdivision the volume, distance and direction of out-migrations	facing p.224
7.5 Histograms for aggregated electoral subdivisions, Adelaide Statistical Division, showing number of intra-urban migrations against direction with reference to	
(1) grid north	
(2) C.B.D.	facing p.225
7.6 Maps showing for each electoral subdivision in the Adelaide Statistical Division	
(1) classification in a threefold concentric zonation	
(2) the mean outmovement by volume, distance and direction	facing p.228

- 7.7 Map showing for each electoral subdivision the quintile classification of the dominant direction of outmovement with the C.B.D. as orientation node facing p. 229
- 7.8 Graphs showing percentage cumulative frequency of direction of outmoves (C.B.D. as orientation node) Adelaide Statistical Division:
(1) range 0° to 180°
(2) 0° to 180° and -180° to 0° facing p. 231
- 7.9 Graphs comparing
(1) distance of origin from C.B.D.
(2) mean length of outmigration, with dominant direction of outmovement facing p. 234
- 7.10 Map showing for each subdivision the quintile classification of the index of directional concentration of outmigration facing p. 237
- 7.11 Graphs showing variation in indices of concentration with
(1) distance of origin from C.B.D.
(2) dominant direction of outmovement facing p. 238
- 8.1 Linkage groups based upon the matrix of simple correlations between selected variables, Adelaide Statistical Division facing p. 270

LIST OF TABLES

Table	Page
1.1 Matrix comparing classification of purposes and scale of urban migration studies	14
3.1 Population changes 1961-1966 and 1966-1971, Local Government Areas (L.G.A.s) Adelaide Statistical Division	facing p. 71
3.2 Classification of Local Government Areas according to rankings on natural increase and net migration 1961-1966	75
3.3 Comparison of net changes in population of electoral subdivisions. Measured by Census Data (1966-1971) and Electoral Rolls (1970-1971)	under p. 87
3.4 Percentage of eligible British Nationals registered as electors in non-metropolitan electoral divisions, June 1966	93
3.5 Percentage of eligible persons actually registered on subdivisional electoral rolls and adjustments to minimize anomalies	facing p. 94
3.6 Comparison of S.A. electorates for Commonwealth and State governments	104
3.7 Comparison of S.A. electoral subdivisions, March 1970	105
3.8 Summary of all electoral deletions Adelaide Statistical Division 16/3/70 to 11/6/71	112
3.9 Summary of Pearson's Correlation Coefficients between categories of deletions (absolute scores)	114
4.1 Mover-stayer analysis: Numbers and relative proportions of movers and stayers measured by census and electoral records	facing p. 128
4.2 Comparison of correlation coefficients of census and electoral derived mover-stayer information	130
4.3 Data from electoral rolls - additions, deletions, internal changes of address and annual indices of movement of electors	facing p. 131

Table	Page	
4.4	Cross classification of electoral subdivisions by annual rates of net migration and population turnover	facing p. 135
4.5	Census derived index of mean annual population turnover (Tt) 1966-1971, Adelaide Statistical Division	137
4.6	Pearson correlation coefficients between (X) indices of net migration and population turnover and (Y) percentage unadjusted and adjusted on the electoral roll, Adelaide Statistical Division	139
5.1	Electoral transfers between subdivisional origins and destinations, Adelaide Statistical Division, 1970-71	facing p. 161
5.2	Matrix showing for each subdivision the number of active links classified by size (volume of movers per link)	facing p. 164
5.3	Internal moves: Rank size distribution of changes of address within electoral subdivisions	facing p. 179
6.1	Transfers in ascending order of distance for each electoral subdivision in the Adelaide Statistical Division, 1970-71	separate fold-outs
6.1/A	Model, stage 1: The network Number of links by length of link a. internal b. active c. inactive	facing p.194
6.1/B	Model, stages 2 and 3: moves with simplifying assumptions Stage 2 - mean electors Stage 3 - all movers	facing p.194
6.1/c	Model, stage 4: actual transfers	facing p.194
7.1	Summary of A.S.D. numbers and percentages of electoral transfers by direction of outmovement with C.B.D. as orientation node	facing p. 215
7.2	Dominant direction of outmovement (Ref. C.B.D.) and Index of Directional Concentration for each Electoral S.D. in the Adelaide Statistical Division	facing p. 219

Table	Page
7.3 Three concentric origin zones, showing percentage of transfers from each, directed toward, away from or laterally, with respect to the Central Business District (C.B.D.)	232
7.4 Correlation coefficients between annual rates of population movement and distance and direction moved	235
7.5 Selected population and elector movement characteristics for three concentric zones of electoral subdivisions in the Adelaide Statistical Division, 1970-1971	under p.238
8.1 Summary of Stimson's factor analysis of Metropolitan Adelaide 1966, based upon data drawn from the census 1966 (Australian Bureau of Statistics)	258
8.2 Definition of variables and derivation of components used in their calculation for statistical analysis	pp. 265, 266, 267
8.3 Matrix of Pearson Correlation Coefficients between all selected variables	facing p.268
8.4 Comparison of ecological correlations between variables in three Australian cities, Brisbane (B), Sydney (S) and Adelaide (A)	facing p.273
8.5 Partial correlation coefficients between (a) annual index of population turnover and various independent variables and (b) annual index of net migration and the same independent variables, based on electoral subdivisions in the Adelaide Statistical Division	facing p.282
8.6 Multiple correlation between population turnover and seven independent variables	facing p.288
8.7 Multiple correlation between net migration and eight independent variables	facing p.289

LIST OF ABBREVIATIONS USED IN THE TEXT

- A.B.S. Australian Bureau of Statistics
 (Formerly known as the Commonwealth Bureau of Census
 and Statistics (C.B.C.S.))
- A.S.D. Adelaide Statistical Division
- C.B.D. Central Business District
- C.D. (Census) collector's district
- L.G.A. Local Government Area
- P.T. Population Turnover
- S.E.D. State Electoral Department
- S.D. (Electoral) sub-division

INTRA-URBAN MIGRATION IN THE ADELAIDE METROPOLITAN AREA;

A SPATIAL ANALYSIS OF SUBURBAN POPULATIONS

BY BRIAN J. WARD

SUMMARY

Intra-urban migration is a young study which lacks widely accepted strongly theoretical perspectives and models other than those general to urban studies. Much exploratory and descriptive work remains to be done before theoreticians can be confident that they know fully the characteristics of the phenomenon they seek to explain. This present study is empirical and its main aim is to identify the patterns of residential movement within the Adelaide Statistical Division, whose boundaries are generally well beyond the fully urbanized areas of the metropolis. The emphasis is on the total movement patterns of the entire city, and because there are no previous studies at this level, sampling is rejected as a means of gathering data for this study. Nevertheless, wherever possible, described patterns are compared with those already available from other studies.

Information on residential movement is obtained from the computer-maintained State Electoral Rolls. Therefore only registered electors are included in counts over the fifteen month study period and various analyses are conducted to estimate spatial variations in the proportion of the population so registered. Statistics from the South Australian electoral rolls are shown, after necessary adjustments,

to be highly correlated with relevant measures gathered at the census within two weeks of the closure of rolls in June 1971.

Spatial comparability between census records and electoral data is achieved by systematic aggregation of census collector's districts into areas matching each of the fifty subdivisions which together comprise the defined study area. For each subdivision a population centroid is calculated by utilizing a co-ordinate grid. In further analysis the centroids are considered as points of origin and destination in a network between whose elements the distance and direction is known and linked by flows of aggregated transferring electors.

Indices of annual rates of both net migration and population turnover (after Moore) prove to be higher than generally expected for Adelaide although the spatial distribution accords reasonably with the classical models of urban form. It is found that the relationship between the frequency distribution of movers and distance moved is similar to findings in other studies. Furthermore, the particular spatial configuration of destinations and distances moved depend on the specific location of the origin areas within the city. Examination, after the Adams model, of directions of out-movement with respect to the central business district (C.B.D.) confirms that patterns are not random and are amenable to classification into concentric zones. A special Index of Directional Concentration is a useful measure of the degree of angular spread of outmoves.

A matrix showing simple correlation coefficients between annual rates of population movement (dependent variables) and selected population characteristics is the basis for application of partial correlation, path analysis and multiple regression. The most important population variables are age and number of children, proportions of private houses and Australian born.

This study points the way for valuable new work utilizing the same sources and procedures to identify for defined areas the kind and degree of population change occurring through streams of intra-urban migrants.

AUTHOR'S STATEMENT

I, BRIAN JOHN WARD, being the author of this thesis, do hereby certify that none of the material presented has been accepted for the award of any other degree or diploma in any university and that, to the best of my knowledge, and belief, the thesis contains no material previously published or written by another person, except when due reference is made in the text of the thesis.

Signed

ACKNOWLEDGMENTS

This volume is the culmination of work begun while the author was a full-time tutor in the Department of Geography of the University of Adelaide. Work has extended over a period of five years by a mixture of full-time and part-time study under a variety of personal circumstances. The task has involved the active support of a considerable number of people to all of whom the author gladly expresses his gratitude. There are, nevertheless, many whose contributions have been such as to require individual acknowledgment.

The project was begun under the guidance of Mr. P.J. Smailes, who, unfortunately, transferred in the latter part of the first year (1970) to Oslo University, Norway. Mr. T.L.C. Griffin kindly took over as supervisor, a role through which he has continued to make valuable contributions. It was his encouragement which led to the publication of the paper "The use of electoral rolls in the study of internal migration." Other academic colleagues who have been generous with their time and ideas are Mr. B.A. Badcock and Mr. K. Hendrie.

Officers of the State Electoral Department made the basic aspects of the project realizable through their generous and sympathetic interest expressed in many ways. Mr. N.B. Douglass, Electoral Commissioner, Mr. J. Guscott, Principal Returning Officer and Mr. R. Graf (now of the Hospitals Department) were the officers who gave most generously of their time and skills.

The Australian Bureau of Statistics (formerly known as the

Commonwealth Bureau of Census and Statistics) numbers amongst its staff in Adelaide officers but for whose painstaking explanations and care in making available the most appropriate materials as required the project could not have survived in the form planned. Mr. J. Glover and Mr. A. Glendenning in particular typify the high standard of professional assistance readily offered.

Help must be acknowledged also from other government departments, especially the Department of Immigration and the Post-Master General's Department. Furthermore the South Australian Public Service Board and the Department of Further Education, in whose employ the author has been an Education Officer (Research) during most of 1975, have allowed study leave (some with pay and most without) to complete this work. The understanding extended to a new employee is appreciated.

An exercise of this size inevitably placed heavy financial strain on several sources of support. Firstly, whilst a member of the staff of the Geography Department, University of Adelaide, funds were received from the University Research Grants through the then head of the Department, Professor G.H. Lawton. Until recently the cost of computing and programming at the Adelaide University's Computing Centre were debited against the budget of the user's Department. On more than one occasion this project has consumed far more than its fair share of the very meagre computing budget of the Department of Geography. Dr. F. Gale, in her capacity as the first elected Chairman of the Department, has been able to overcome

a bewildering variety of problems, some of which have concerned this research project. Her patient encouragement and boundless enthusiasm have assisted considerably in its reaching fruition.

Members of the ancillary staff of the Department of Geography have rendered valued assistance in their respective fields. Mrs. A. Johnsen and Mrs. S. Evans have provided typing and Mr. M. Foale and Miss C. Barrington, cartographic and photographic services. Miss R. Thomson and Mrs. D. Sage both employed from Departmental funds as research assistants at various times gave valuable help in the laborious task of diagrammatically representing much of the data.

For processing of much of the data, heavy reliance was placed upon the services of the 6400 series CDC Computer of the University of Adelaide. This would have been impossible without the special programmes prepared by Miss Robyn Lewis and Mrs. Chris. Klingner.

A lifelong friend Mr. J.R. Kimber has sacrificed hundreds of hours of his private time without fee to prepare the final version of all the graphs. In so doing his domestic life has had to be neglected to an extent which makes gratitude of suitable magnitude difficult to express.

It is the author's firm belief that diagrammatic representation of data is much to be preferred, the more so in the present case because the amount of numeric information collected is so large. Available resources had been stretched to obtain the data, were further stretched to process it and finally broke when the time came

to represent it diagrammatically. This led to the employment, at very considerable personal cost to the author, of the commercial professional services of Mr. Bernhard Ruthenbeck of Hemruth Graphics. Gratitude must be expressed for the speed, skill and co-operativeness of the services provided without which the thesis would have foundered in its final stages.

With the Geography Department unable to give further production assistance with typing Mrs. J. Schilling was privately commissioned and her help is gratefully acknowledged, particularly in the demanding last stages.

Acknowledgment of the greatest single source of assistance, that of my wife June, has been kept until last. Not only has she borne the brunt of the financial burdens by supporting us both during the periods of full-time study but she has spent countless hours with numerous arduous chores such as tabulating, calculating, plotting, filing, mapping and typing. As a graduate in geography and a professional educator she has provided a trained mind upon which to try out ideas. During the crises, which seem inevitable in projects as long and involved as this one, she has been a veritable tower of strength with her loving faith, patience and encouragement. Furthermore without her self-effacing example of courage and hard work the project must surely have come to a premature end.

Many other colleagues, friends and relations have assisted in ways too numerous to mention here. Several more are mentioned in footnotes but that others are not named is no less an indication of the author's gratitude which it is hoped will be accepted by all who have helped to bring this research project to its present form.

CHAPTER 1

INTRA-URBAN MIGRATION IN THE BROADER CONTEXT OF POPULATION AND
MOVEMENT STUDIES

...an understanding of which households will move in a given time period, where they will move, and why, is of crucial importance in designing adequate residential land use models.

BUTLER (1968, p.1)

OUTLINE

After defining various sets from the universe of human movement and attempting to separate the terms "mobility" and "migration", interest is focused down to the newly developing study of intra-urban migration. A selection of studies from the literature is briefly reviewed under the following three headings: descriptive, explanatory, and predictive. Although theoretical perspectives and models of intra-urban migration are not well developed some useful pragmatic generalizations are extracted for testing in the present study.

CHAPTER 1. INTRA-URBAN MIGRATION IN THE BROADER CONTEXT OF
POPULATION AND MOVEMENT STUDIES

CONTENTS

	Page
1.1 INTRODUCTION	4
1.2 THE DEFINITION AND CLASSIFICATION OF POPULATION MOVEMENTS	5
1.3 MIGRATION STUDIES IN GENERAL AND URBAN CONTENTS	11
1.3.1 Examples of Descriptive Studies	15
1.3.2 Examples of Explanatory Studies	16
1.3.3 Examples of Predictive Studies	19
1.4 MODELS AND LEVELS OF GENERALIZATION	19
1.5 THIS STUDY	23
REFERENCES	25

CHAPTER 1: INTRA-URBAN MIGRATION IN THE BROADER CONTEXT OF
POPULATION AND MOVEMENT STUDIES

LIST OF FIGURES

Figures	Page
1.1 A classification of human movement	7
1.2 A three-dimensional classification of studies in human movement	14

LIST OF TABLES

Tables	Page
1.1 Matrix comparing classification of purposes and scale of urban migration studies	14

CHAPTER 1: INTRA-URBAN MIGRATION IN THE BROADER CONTEXT OF
POPULATION AND MOVEMENT STUDIES

1.1 INTRODUCTION

To claim that all human movement is a phenomenon of space and time is a truism, but it does make apparent dimensions within which it may be measured. The extreme diversity (not to mention impermanence) of human movement makes it extremely difficult to study. Each person, for example, considered as a single element undertakes many movements with differing dimensions and purposes even in one day. Haggett (1965, p. 32) says that rather than regarding human population as a static feature, as portrayed in the dot maps of conventional geographical analysis, it should be viewed as "a complex of oscillating particles, with short loops connecting places of sleep, work and recreation, and larger loops connecting old hearths and new areas of migration".

Despite man's historic propensity to move about, the separate formal geographic study of his movements as such is not of long standing. It is believed by Haggett (1965, p. 31) that "movement is an aspect of regional organization that has been too lightly stressed in human geography". This has come about, Haggett says, through over-concentration on the study of static elements on the earth at the expense of the dynamic aspects of systems and the factors and processes which manifest themselves spatially. The underlying implication is that to achieve understanding and sound explanation of spatial distributions requires not only knowledge

of the distributions themselves (even if necessarily static 'snapshot' views) but also of the forces operating through time which give rise to those distributions. It is to be expected then that geographic study of human movement will lead to improved understanding of the spatial distribution of various human attributes and activities. Urban and community planners with improved understanding in this area should be better able to recommend actions whose consequences for specified groups will be clear, thereby facilitating the attainment of legitimate community goals. Toward such an end it is humbly hoped that this present research project on residential movement within a particular urban area will contribute.

1.2 THE DEFINITION AND CLASSIFICATION OF POPULATION MOVEMENTS

The study of a phenomenon as complex and varied as human movement, it is clear, must be subdivided into more easily managed categories. For example Clarke (1965) discusses population movements under the headings of duration, distance and organization, with the claim that simple classification is impossible, while Petersen (1958) has attempted a classification of migration according to motivation or stimulus. However neither of these schemes is very useful in the present context where interest is focused on 'migration' and that within an urban area. It is clear that 'migration' is but one aspect of human movement and as such requires explanation and clarification which now follow.

In the literature the terms 'migration' and 'mobility' seem to be used interchangeably by some authors and in rather more restricted senses by others. For example Clark (1970, p.49) says "The term residential mobility is generally used to refer to short intra-community moves, while migration is used for moves of greater distance, from city to city and state to state". Simmons (1968, p.622) follows the practice of the United States Bureau of Census in restricting the use of the term 'migration' to movements across county lines so that other movement is necessarily 'mobility'. It is frequently unclear whether the two terms refer to discrete sets of moves or whether one is a subset of the other. The difficulties are associated with lack of delineation of the classificatory attributes of the moves being studied. For example it seems that some of the uncertainty in usage may arise from separate application of the term 'mobility' to moves which are said to be 'short' on either of two dimensions, namely distance or time. It is proposed in the present work to limit use of the term in accordance with the relationships represented in Figure 1.1 and the accompanying definitions.

'Migration' has been the subject of much research writing and model building ranging from the pioneer British work by Ravenstein (1885) to the Swedish studies of Hägerstrand (1957) and Olsson (1965b) who along with Moore (1966a) provide valuable reviews of the whole subject. However given that the present study is primarily concerned with movement within a city note must be taken of the judgement by Simmons (1968, p. 622-623) that general migration studies and

the review papers "have limited application to movement within urban areas because economic opportunity, the mainstay of migration theory at the interstate and international levels, is largely irrelevant to movement within a community area or to patterns of gross migration".

The main purpose of the accompanying diagram, Figure 1.1, is to show the special topic of this study, intra-urban migration, within the broader context of human movement in general. The placement depends of course upon definitions and their interpretations. 'Mobility' is being applied to the whole universe of human movement, a usage which seems not too conflicting with recent writers such as Simmons, Brown and Moore.

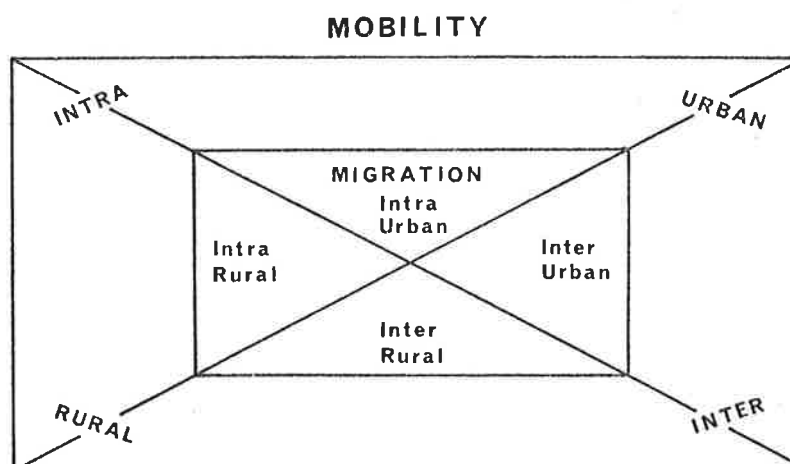

FIG. 1.1. A Classification of Human Movement.

Notes: 1. Universe may be International or Intra-national.
2. Absent: Time Intention.

The diagram shows migration as a discrete set of movements, a division based upon the following. 'Migration' is used here to describe any "permanent or semipermanent change of place of

residence" (Lee, 1966, p.50). This is broader than the usual definition derived from Hägerstrand (1957, p.28) where movement occurs across administrative boundaries. It should be acknowledged, therefore, that the choice of data source(s) ultimately defines the practical meaning of 'migration' in a given study. As will be discussed later, for example, the use of electoral rolls as data source on migration usually means that migration is the transfer by an elector of his place of residence across at least one electoral (or subdivisional) boundary, evidenced by transfer of name from one roll to another. It must be noted however that these features are not inevitable limitations on the practical application of 'migration' because the advent of computer-maintained rolls enables usage free of the restraints of administrative boundaries (see Ward, 1975, p.95).

In Figure 1.1 the complement to the 'migration' set is an unlabelled remnant of the 'mobility' universe. By implication it consists of those movements which lack the attribute of being permanent or semi-permanent changes of place of residence. No suitable term has suggested itself for this category and 'mobility' itself seems inappropriate because of its current mixed usage.

Until the last decade most migration studies concentrated on residential change other than that within urban areas and the main concern has been with rural areas and the rural to urban flow. For example Ravenstein (1885) examined inter-rural and rural to urban movements by counties for the whole United Kingdom in formulating

his "laws of migration". Hägerstrand (1957) considered the migration fields (both in and out) of a selection of Swedish parishes and towns. Movements studied were mostly inter-rural but some were rural to urban. Olsson (1965) in his Swedish migration studies, specifically excluded intra-urban movement. Generalizations and models concerning migration have been developed therefore on a mainly rural basis. As already noted Simmons (1968, p.622-623) has questioned the relevance of applying such findings to urbanized areas.

There are obvious differences between both the populations and the environments of rural and urban areas. These have been the subject of intensive investigations at least since the 1920's and gave rise to the now famous Chicago School of Sociologists. Often described are such population differences as age structure, sex ratios, fertility and occupation as well as differences in social behaviour, values and perception (see for example Wilson, 1968). Given that differences between urban and rural populations tend to be so marked it is to be expected that residential movements will manifest differences of a comparable order - something yet to be adequately researched. One important difference inherent in the study of urban areas is the use of smaller but more densely populated areas than those in rural and rural to urban studies.

It is important that the study of intra-urban migration be developed not only as a complement to the knowledge accumulated already of movements over wider territories but also because an

ever increasing proportion of the world's population lives in cities which are increasingly subject to "planning" of various kinds. It has been noted by Moore (1966a, p.16) that "as social scientists have probed deeper into the fabric of urban communities, the importance of residential mobility as the proximal cause of changes in the social structure of cities has become widely appreciated." There can be little doubt that along with the increasing numbers of people residing in the cities goes growth in political and economic influence invested there. Furthermore the scale and complexity of modern civilization requires that much corporate activity be planned with greater skill and insight than formerly to achieve publicly accepted goals. These ideals can be fulfilled only if relevant information and suitable models are available to planners and decision-makers who increasingly seek and use such tools. Despite this growth Moore (1969b, p.116) was able to claim that "understanding of intra-urban migration is still poorly developed".

The recency of the development of studies in intra-urban migration and the previous lack of materials in this area may be gauged from a brief examination of a few standard texts of the last decade in 'Population Geography.' For example Beaujeu-Garnier (1966), Clarke (1965) and Wilson (1968) each have at least one comprehensive chapter covering many aspects of migration. Not one of them has even a mention of intra-urban migration. The late development of this study is emphasized in the following terms by Whitelaw (1973, p.75) "it is only within the last decade that

geographers have given a good deal of attention to the very high rates of mobility within urban areas." The judgements separately expressed years ago by Moore (1966a, p.16) and Kirk (1958, p.317) that there is a strong need for further effort to be concentrated into the study of intra-urban residential movement and the development of a theoretical base are still relevant today.

1.3 MIGRATION STUDIES IN GENERAL AND URBAN CONTEXTS

Publications of the last decade provide ready evidence of the increasing recognition that human migration is the proximal cause of changes in the social structure of cities. For example, Bolwell et al. (1969) have shown in Crawley, a British "new town", that out-migration of upper and middle class families caused an alteration in the structure and balance of the city's population between 1961 and 1966. Morrill (1965c) and Rose (1970) have separately described and simulated the invasion and succession process by which large areas of American cities have changed social structure and status when negroes have moved in. The dispersion of various ethnic groups within urban areas has been described by Jakle and Wheeler (1969) and Gibson (1967). The movement, not of people directly, but of areas of high status has been noted by Hoyt (1939) and Johnston (1966). Nevertheless, Simmons (1968, p.649) remarked that probably the most remarkable feature of intra-urban mobility is "the stability of social characteristics of neighborhoods in spite of the high mobility rates throughout the city". Chugg (1971) has found evidence to support this in parts of Adelaide.

From the above stems an interesting but as yet unanswered question as to what extent intra-urban migrants add their pre-move social characteristics unaltered to the aggregate of their new areas and how much they adapt, involuntarily or otherwise to the existing social characteristics of the new area. Associated with this is the matter of the extent to which movers select areas deliberately or accidentally of the same or different social pattern from the area they leave. It is obvious that the migrant's simple population characteristics like age, sex, nationality and marital status are involuntarily and objectively subtracted from the aggregation of his donor area and added to those of his receptor area.

Implicit in the above discussion has been the notion of two different kinds of subjects for population research, firstly aggregated or group behaviour and secondly individual behaviour. Both these have been followed in recent years, depending rather on the preference and purpose of the researcher. Earlier studies of intra-urban changes of residence were generally at the aggregate level, but in an effort to understand more fully the nature of the processes operating at that level "increasing attention is being focused on the structure of the decision-making process at the individual level" (Moore, 1969b, p.113). In spite of this however the needs of planners in particular to have viable models of urban structure and urban growth has caused "a revival of interest in aggregate areal relationships" (Moore, 1969a, p.18).

Existing studies in intra-urban migration may be considered

under any number of headings or subdivisions. One system of classification which provides a useful framework for the present discussion is that proposed as a tentative typology by Moore (1966a, p.19). He uses a threefold division of studies according to their major intent without implying that they must be necessarily of single purpose. Studies are said to be descriptive, explanatory or predictive. His further division into areal or non-areal serves no useful purpose here as the present concern is clearly with spatial distributions.

Nevertheless, a useful view which may be added has been posed by Whitelaw (1972, p.101) who has attempted to resolve apparent conflict between the behavioural approach and the normative approach in the study of urban migrant behaviour. He suggests that the conflict derives from different interpretations based on differences of scale in three possible dimensions, namely, space (area), time (frequency) and activity type. This classification superimposed upon that of Moore provides a scheme more appropriate to the present purpose than either alone.

The combined scheme is represented in the accompanying Table 1.1, as a two dimensional matrix.

Table 1.1

Matrix comparing classification of purposes and scale of urban migration studies

Main concern of the study	1. Description	2. Explanation	3. Prediction
Scale			
1. Area			
2. Time/frequency			
3. Urban migration activity type			

Source: After Moore, 1966a and Whitelaw, 1972.

The possible range of relationships is portrayed much more clearly in the three-dimensional block diagram shown below (see Figure 1.2). This classification, and the 'purpose' dimension in particular, provides a structure for the following discussion of selected studies in intra-urban migration. The purpose is to provide a frame of reference within which this present project may be viewed.

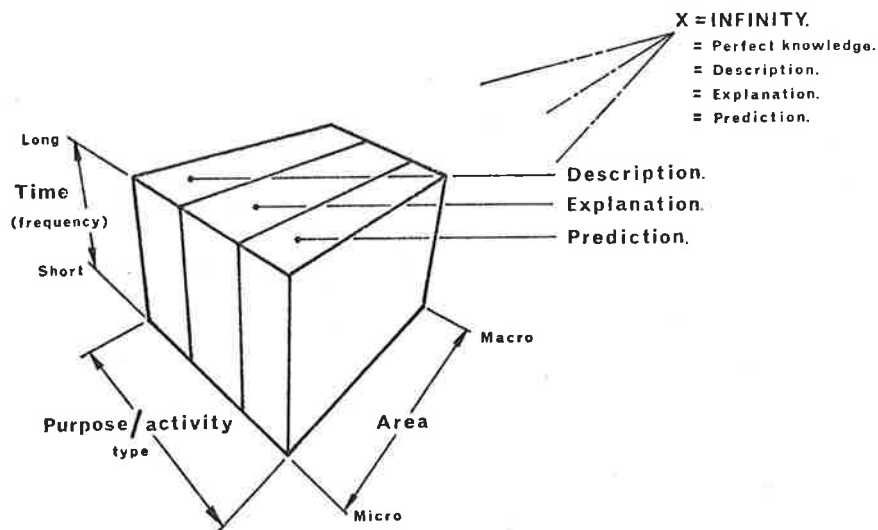

FIG. 1.2. A Three-dimensional Classification of studies in Human Movement, (after Moore, 1966 and Whitelaw, 1972).

1.3.1 Example of Descriptive Studies:

In the selected cases cited below the description referred to has formed only part of the particular study and was not an end in itself.

Moore (1966b) has described for a major portion of the Brisbane metropolitan area rates of population movement over a seven year period and identified certain associated population characteristics in his construction of various mathematical models. Several studies in Melbourne have described residential movements. For example, Johnston (1969a) has described levels of mobility for the entire city over a short period while testing a model of intra-urban mobility. Other authors have worked on selected areas and sample populations particularly researching behavioural aspects of residential transfers, for example Whitelaw and Gregson (1972), Whitelaw and Robinson (1972) and Humphreys (1973). As part of a study of internal migration throughout South Australia, Hugo (1971) has recorded gross in and out movements and rates of net migration between 1961 and 1966 in the Adelaide metropolitan area by local government areas. Gibson (1967) and Chugg (1971) have each described individual movement in Adelaide for selected sub-groups of the population. Gibson studied the moves of a sample of Dutch and Greek migrants over the ten years after arrival. Chugg noted all in and out moves by electors for

two small specified study areas during an eight month period. About two-thirds of the Sydney area was studied by Sinclair (1975) who calculated population turnover rates for the five year intercensal period 1966-71 and identified levels of association with certain population characteristics. The volume and direction of residential movement during 1965 in the entire metropolitan area of Christchurch has been described by Clark (1970 and 1971) who investigated spatial bias and associated population characteristics. Donaldson and Johnston (1973) working in a sector of the same city identified particular aggregated movement patterns with familiarity levels and "mental maps" of transferring residents.

1.3.2 Examples of Explanatory Studies:

Rossi (1955b, p.177) claimed in his seminal study of Philadelphia that "each individual move is not a random event but is determined by a household's needs, dissatisfactions and aspirations." Adams (1969) has argued that directional properties of residential moves within urban areas are similarly not random. He claimed that under various theoretical circumstances residential movements should display 'directional bias' with respect to the direction of the Central Business District (C.B.D.) from the point of origin. This has been tested in several of the studies already mentioned, namely in Melbourne by Whitelaw and Robinson (1972), Whitelaw and Gregson (1972) and Humphreys (1973), and in Christchurch

by Clark (1971).

Aggregated rates of residential migration have been shown to vary both for different sub-groups of urban populations controlled for location and for different areas of a city. Spatial variability has been shown to correlate significantly with several population characteristics in Brisbane (Moore 1966b, 1969a, 1972) and in Christchurch (Clark 1970). Wheeler (1967 and 1968) in a study covering the whole of Pittsburg for 1968 showed that both distance travelled to work and residential location correlated positively with occupational status. There was therefore the implication that residential movement might be similarly dependent on occupational status.

The so-called behavioural approach attempts to explain migration by studying "within a decision making framework" (Horton and Reynolds 1970, p.1) sets of individual cases in the context of their life space, their experienced and perceived place utility, status, needs and expectations. The urban environment and the areal sub-units within which cases are viewed is typically described "using ecological data describing socio-economic characteristics" (Brown and Longbrake 1969, p.170). Some other studies of this kind have been concerned with the implementation of place utility (Brown and Longbrake (1969), the relationship of functional distance and migratory flows (Brown and Horton 1970), the spatial biases in individual sequences of residential moves (Brown and Holmes, 1971), the spatial aspects of search behaviour (Brown and Holmes, 1970) and

comparison of action space with search space in relation to perceived residential quality (Horton and Reynolds 1970). The papers mentioned in this paragraph have been based upon a major continuing study in the city of Cedar Rapids, Iowa, U.S.A. Some papers covered moves over a fifteen year period and others recent moves only. At the centre of this outburst of predominantly behavioural studies has been Professor Lawrence A. Brown of the Ohio State University.

The classic early study in the behavioural style was that by Rossi (1955) in answer to the question of why families move. After a city-wide survey of Philadelphia he interviewed samples of households selected from four type subareas. He concluded that "each individual move is .. determined by a household's needs, dissatisfactions, and aspirations" (Rossi, 1955, p.177). Needs depend upon the composition of the household and space requirements, both of which vary according to stage in the life cycle of members of the household. In his study, levels of mobility varied not only with socio-economic status of the population but also with the quality and size of dwellings. At either extreme of the socio-economic scale there were identified areas of both high and low mobility.

Boyce (1969) studied changes of occupancy over a five year period in more than two thousand residences in Seattle. He found that, generally, economic forces acting as "push" factors at the originating site of moves were more significant than those acting as "pull" or attracting factors at the destination.

1.3.3 Examples of Predictive Studies:

Studies with the main purpose of predicting future patterns in intra-urban migration are relatively few. Morrill (1965a) has determined actual movement patterns of negroes over a twenty year span in ghetto areas in Seattle in order to develop a probabilistic simulation model. His aim was "to trace the origin of the ghetto and the forces that perpetuate it and to evaluate proposals for controlling it" (Morrill, 1965a, p.339). A conceptually similar model was developed by the same author (Morrill, 1965b) for a seven year period on the edge of the Seattle urban area to trace spatial and temporal changes in land-use. Although the main topic is clearly land-use change there are close links with residential movement because growth in the urban fringe according to Morrill (1965b, p.185) "represents one of the largest, if most local, migration streams in the country". Rose (1970) has applied similar techniques to devise a "ghetto-developer model" using data from Milwaukee, Wisconsin for a ten year period. Residential movements over five years in Christchurch were also the basis of a simulation model (Clark, 1970).

1.4 MODELS AND LEVELS OF GENERALIZATION

It is noteworthy that there exists no comprehensive all-embracing theoretical model of migration nor of intra-urban migration. However, successful models have been developed to describe some aspects of the phenomenon. For example, there are many variations of the "gravity model" used in the study of

migration fields to explain observed fall-off in the number of migrants with increasing distance from the centre of origin (see Hägerstrand 1957, Morrill 1965a and Olsson 1965a). Stouffer (1940) supplemented this with his theory of 'intervening opportunities'. Such models are particularly useful at the macro-scale, especially in the inter-urban case. Nevertheless Hägerstrand (1957, p.150) argued that since migration fields result from historically continuous feed-back, it would be "vain to look for a deterministic theory connecting migration and distance".

As already noted there has been a strong trend in intra-urban migration studies in the last decade to concentrate on the individual decision maker in an effort to improve understanding of processes operating at the aggregate level (Moore, 1969b, p.113). Psycho-sociological topics have been prominent with investigations of such topics as motivation for moving or not moving, individual perception, experience, reasoning and decision making. It is clear that for the sake of geographic meaning the individual move must be seen in its spatial context as part of an aggregate of moves. The lone move lacks general meaning apart from the total pattern of which it is a part.

In a single handed research study like this present one it is difficult to utilize a range of approaches as comprehensive as that already outlined. Yet without the comprehensiveness of complementary views applied in the study of a single city findings are to a considerable extent disparate and valid generalizations minimal.

This problem has been substantially reduced by the team of workers who have grouped themselves around Lawrence A. Brown at Ohio State University. They are quarrying a mine of detailed data accumulated on the small city of Cedar Rapids. Studies are made variously at the macro or micro level and may be supplemented by additional field work. In this way the accumulating studies of the whole city system and the moving behaviour of its citizens (individual and aggregated) are complementary, thereby raising the hope that valid generalization about inter-relationships may be achieved. Nevertheless, it must be remembered that concentrated and expert though all the effort is, the subject of study is but a single city and the universality of general findings can be established only by replication in the widest possible range of cities (Moore, 1969b, p.115-116).

Despite the lack of comprehensive theoretical models of human migration already noted, there are a number of widely accepted (if not universal) generalizations which apply to migration generally and intra-urban migration in particular, and these are listed below under those subheadings.

(a) Migration generally

1. Most moves are over a short distance (Ravenstein, 1885, p.198).
2. Migration streams often consist of a series of steps or staging points linking a more distant hearth or origin area to a destination (Ravenstein, 1885, p.199;

Hägerstrand, 1957; Morrill, 1963 and 1965; and Stouffer, 1940).

3. Flows are often "two way", therefore counter flows may be observed between the destination and origin of the dominant flows (Ravenstein, 1885, p.199).

(b) Intra-urban migration, in addition to the above properties, has the following general characteristics.

1. Most moves

- . are centrifugal or outward, away from the C.B.D.
(Concentric ring theory of Burgess, 1925; Adams, 1969)
- . are made within the same sector, thus showing directional bias (Sector theory of Hoyt, 1939; Adams, 1969)
- . are between areas of the same or similar socio-economic status (Simmons, 1968)
- . occur within areas already part of the mover's "life span"
(Brown and Longbrake, 1970; Brown and Holmes, 1970; Brown and Holmes, 1971)
- . are made to satisfy better the mover's accommodation needs (Rossi, 1955; Simmons, 1968)
- . are made by young adults, single persons or newly established couples or retirees (Simmons, 1968; Rossi, 1955; Moore, 1972)
- . originate in inner or middle suburbs (Adams, 1969)
- . terminate in the growing outer suburbs with their new housing (Burgess, 1925; Adams, 1969)

2. Furthermore

- . rates of movement vary spatially from high net out-

migration from the inner city to high net in-migration in the urban fringe (Johnston, 1969a)

- population turnover varies according to relative location (high in inner areas and low in the fringe) but also according to certain population characteristics (Moore, 1969a).

Most of the above generalizations will be tested in the Adelaide situation in the course of this present study.

1.5 THIS STUDY

A consultant to the South Australian Government in a report on Adelaide's transportation planning bemoaned the fact that there were "no data available concerning the (residential) mobility of the citizenry" (Breuning, 1970, p.24). It is hoped that this study will provide some, however brief. It is planned to describe the total migration pattern within the urbanized region of Adelaide for approximately a year. It has been mentioned already that Adelaide has been the subject of several partial studies (Hugo, 1971a; Martin, 1970; Gibson, 1967; Chugg, 1971; and Stimson, 1971). These provide only a very small reference base and the scale of the task does not permit the desirable examination of the individual decision making which has contributed to the movement pattern described. On the other hand to have elected first to study individual moves, their motivation and decision making would have precluded identification of the overall movement patterns. Under

such circumstances spatial sampling of moves would have been impossible because the distribution of the parent population of moves would have remained unknown. It is the aim of this study to provide such a descriptive base. From it more pertinent questions can be asked. Hopefully future studies will find it useful, particularly in devising sampling schemes for investigating behavioural aspects of the intra-urban migration.

The chosen emphasis is on the characteristics of the moves themselves, their numbers and the dimensions of distance and direction. The movement characteristics are then to be compared by correlation analysis with selected characteristics of the population in an effort to discover possible explanatory factors which could form the bases for further research. The following chapter outlines the project in greater detail.

REFERENCES

- ADAMS, J.S. (1969) 'Directional Bias in Intra-urban Migration'. Economic Geography, vol. 45, no. 4, pp. 302-323.
- BEAUJEU-GARNIER, J. (1966) Geography of Population. Translated by S.H. Beaver. Longmans, London.
- BOLWELL, L., CLARKE, B. and STOPPARD, D. (1969) 'Social Class in a New Town: A Comment'. Urban Studies, vol. 6, no. 1, pp. 93-96.
- BOYCE, R.R. (1969) 'Residential Mobility and its Implications for Urban Spatial Change'. Proceedings, Association of American Geographers, 1, pp. 22-26.
- BREUNING, S.M. (1970) Adelaide Transportation 1970 Report. Social Technology Systems Inc., Massachusetts.
- BROWN, L.A. and HOLMES, J. (1969) 'The Delimitation of Functional Regions, Nodal Regions, and Hierarchies by Functional Distance Approaches: An Unconnected Network Example and Overview'. Ohio State University. (Mimeographed)
- BROWN, L.A. and HOLMES, J. (1970) 'Search Behaviour in an Intra-urban Migration Context: A Spatial Perspective'. In Population and Migration in an Urban Context: A Spatial Perspective, Meetings of Population Association of America.
- BROWN, L.A. and HOLMES, J. (1971) 'Intra-urban Migrant Lifelines: A Spatial View'. Demography, vol. 8, no.1, pp.103-122.
- BROWN, L.A. and HORTON, F.E. (1970a) 'Functional Distance: An Operational Approach'. Geographical Analysis, vol. 2, no. 1, pp. 76-83.
- BROWN, L.A. and HORTON, F.E. (1970b) 'Social Area Change: An Empirical Analysis'. Urban Studies, vol. 7, no. 3, pp. 271-288.
- BROWN, L.A. and LONGBRAKE, D. (1969) 'On the Implementation of Place Utility and Related Concepts: The Intra-urban Migration Case'. In Behavioural Problems in Geography: A Symposium. Edited by Kevin R. Cox and Reginald G. Golledge, Studies In Geography no. 17, Dept. of Geography, Northwestern University, Evanston, Illinois.
- BURGESS, E.W. (1925) 'The Growth of the City'. In The City. Edited by R.E. Park, E.W. Burgess and R.D. McKenzie. University of Chicago, pp. 47-62.

- BROWN, L.A. and LONGBRAKE, D.G. (1970) 'Migration Flows in Intra-urban Space: Place Utility Considerations'. Annals, Association of American Geographers, vol.60, no. 2, pp.368-384.
- BROWN, L.A. and MOORE, E.G. (1970) 'Intra-urban Migration: A Perspective'. Geografiska Annaler, Series B, vol. 52, no. 1, pp.1-13.
- CHUGG, D.R. (1971) 'Population Change and Intra-urban Migration in Adelaide, 1961-70'. Unpublished thesis, Geography Dept, University of Adelaide.
- CLARK, W.A.V. (1970) 'Measurement and Explanation in Intra-urban Residential Mobility'. Tijdschrift Voor Econ. En. Soc. Geog., vol. lxi, no. 1, pp.49-57.
- CLARK, W.A.V. (1971) 'A Test of Directional Bias in Residential Mobility'. In Perspectives in Geography, I - Models of Spatial Variation. Edited by Harold McConnell and David Yaseen, Northern Illinois University Press, Illinois, pp.2-27.
- CLARKE, J.I. (1965) Population Geography. Pergamon Press, London.
- DONALDSON, B. and JOHNSTON, R.J. (1973) 'Intra-urban Sectoral Mental Maps: Further Evidence from an Extended Methodology'. Geographical Analysis, vol. 5, no. 1 pp.45-54.
- GIBSON, J.G. (1967) 'The Residential Pattern and Mobility of Dutch and Greek Migrants in the Adelaide Metropolitan Area'. Unpublished thesis. Dept. of Geography, University of Adelaide.
- HÄGERSTRAND, T. (1957) 'Migration and Area'. Lund Studies in Geography, Series B, no. 13, pp. 27-158.
- HAGGETT, P. (1965) Locational Analysis in Human Geography. Edward Arnold Ltd., London.
- HORTON, R.E. and REYNOLDS, D.R. (1970) 'Intra-urban Migration and the Perception of Residential Quality'. In Population and Migration in an Urban Context: A Spatial Perspective (Paper No. 4), Meetings of the Population Association of America.
- HORTON, F.E. and REYNOLDS, D.R. (1971a) 'Effects of Urban Spatial Structure on Individual Behaviour'. Economic Geography, vol. 47, no. 1, pp.36-48.

- HORTON, F.E. and REYNOLDS, D.R. (1971b) 'Action Space Differentials in Cities'. In Perspectives in Spatial Geography, I. Models of Spatial Variation. Edited by Harold McConnell and David A Yaseen, Northern Illinois University Press, Illinois, pp.83-104.
- HOYT, H. (1939) 'The Pattern of Movement of Residential Rental Neighbourhoods'. Reprinted in Readings in Urban Geography. Edited by H.M. Mayer and C.F. Kohn, University of Chicago Press, Chicago, 1959, pp.499-510.
- HUGO, G.J. (1971a) 'Internal Migration in South Australia 1961-1966'. Unpublished M.A. thesis, Dept. of Geography, Flinders University, S.A.
- HUGO, G.J. (1971b) 'Rural-urban Migration in South Australia, 1961-1966'. 43rd Anzaas Congress, Section 21, Brisbane.
- HUMPHREYS, J.S. (1973) 'Intra-urban Migration and Residential Structure'. No. 6, Monash Publications in Geography, Monash University, Melbourne.
- JAKLE, J.A. and WHEELER, J.O. (1969) 'The Changing Residential Structure of the Dutch Population in Kalamazoo, Michigan'. Annals, Association of American Geographers, vol. 49, no. 3, pp.441-460.
- JOHNSTON, R.J. (1966a) 'The Location of High Status Residential Areas'. Geografiska Annaler, vol. 48 (Series B), no. 1, pp. 23-35.
- JOHNSTON, R.J. (1969a) 'Some Tests of a Model of Intra-urban Population Mobility: Melbourne, South Australia'. Urban Studies, vol. 6, no. 1, pp.34-57.
- KIRK, D. (1958) 'Major Migrations Since World War II'. Reprinted in Population Geography: A Reader, Edited by G.J. Demko, H.M. Rose, and G.A. Schnell. McGraw-Hill, New York, 1970, pp.307-318.
- LEE, E.S. (1966) 'A Theory of Migration'. Demography, vol. 3, pp.47-57.
- MARTIN, J.I. (1967) 'Extended Kinship Ties: An Adelaide Study'. Australian and New Zealand Journal of Sociology, vol. 3, no. 1, pp.44-63.
- MARTIN, J.L. (1970) 'Suburbia: Community and Network'. In Australian Society: A Sociological Introduction. Edited by A.F. Davies and S. Encel, Cheshire, Melbourne.

- MOORE, E.G. (1966a) 'Models of Migration and the Intra-urban Case'. Australian and New Zealand Journal of Sociology, vol. 2, no. 1, pp.16-37.
- MOORE, E.G. (1966b) 'Residential Mobility in an Urban Context: A Systems Approach'. Unpublished Ph.D. thesis, University of Queensland.
- MOORE, E.G. (1969a) 'The Structure of Intra-urban Movement Rates: An Ecological Model'. Urban Studies, vol. 6, no. 1, pp. 17-33.
- MOORE, E.G. (1969b) 'The Nature of Intra-urban Migration and Some Relevant Research Strategies'. Proceedings of the Association of American Geographers, pp. 113-116.
- MOORE, E.G. (1970) 'Intra-urban Residential Mobility and Urban Spatial Structure'. In Population and Migration in an Urban Context: A Spatial Perspective. (Paper no. 1) Meetings of the Population Association of America.
- MOORE, E.G. (1971) 'Comments on the Use of Ecological Models in the Study of Residential Mobility in the City'. Economic Geography, vol. 47, no. 1, pp.73-85.
- MOORE, E.G. (1972) 'Residential Mobility in the City'. Association of American Geographers, Commission on College Geography, Resource Paper no. 13.
- MORRILL, R.L. (1965a) 'Migration and the Spread and Growth of Urban Settlement'. Lund Studies in Geography, Series B. No.26.
- MORRILL, R.L. (1965b) 'Expansion of the Urban Fringe: A Simulation Experiment'. The Regional Science Association Papers, vol. 15, pp. 185-199.
- MORRILL, R.L. (1965c) 'The Negro Ghetto: Problems and Alternatives'. Geographical Review, vol. 55, pp.339-361.
- OLSSON, G. (1965a) 'Distance and Human Interaction A Migration Study'. Geografiska Annaler (Series B), vol. 47 B, pp.3-43.
- OLSSON, G. (1965b) Distance and Human Interaction: A Review and Bibliography. Bibliography Series no. 2. Regional Science Research Institute.
- PETERSEN, W. (1958) 'A General Typology of Migration'. American Sociological Review, vol. 23, pp.256-266.
- RAVENSTEIN, E.G. (1885) 'The Laws of Migration'. Journal of the Royal Statistical Society, vol. 48, pp.167-235.

- ROSE, H. (1970) 'The Development of an Urban Subsystem: The Case of the Negro Ghetto'. Annals, Association of American Geographers, vol. 60, no. 1, pp.1-17.
- ROSSI, P.H. (1955b) Why Families Move: A Study in the Social Psychology of Urban Residential Mobility. The Free Press, New York.
- SIMMONS, J.W. (1968) 'Changing Residence in the City - A Review of Intra-urban Mobility'. Geographical Review, Vol.58, no. 4, pp. 622-651.
- SINCLAIR, D. (1975) 'A Causal Analysis of Population Turnover Rates'. Geography Bulletin, vol. 7, no. 1, pp.4-13.
- STIMSON, R.J. and CLELAND, E.A. (1975) A Socio-Economic Atlas of Adelaide An Analysis of the 1971 Census. School of Social Sciences, The Flinders University of S.A. and the Department for Community Welfare, South Australia.
- STIMSON, R.J. (1971) 'Social Differentiation in Residential Areas in Adelaide'. 43rd Anzaas Congress, Section 21, Brisbane.
- STOUFFER, S.A. (1940) 'Intervening Opportunities: A Theory Relating Mobility and Distance'. American Sociological Review, vol. 5, pp.845-867.
- WARD, B.J. (1975) 'The Use of Electoral Rolls in the Study of Internal Migration'. Australian Geographical Studies, vol. 13, no. 1, 94-107.
- WHEELER, J.O. (1967) 'Occupational Status and Work Trips: A Minimum Distance Approach'. Social Forces, vol. 45, pp. 508-515.
- WHEELER, J.O. (1968) 'Residential Location by Occupational Status'. Urban Studies, vol. 5, no. 1, pp.24-32.
- WHITELAW, J.S. (1972) 'Scale and Urban Migrant Behaviour'. Australian Geographical Studies, vol. 10, no. 1. pp. 101-106.
- WHITELAW, J.S. (1973) 'Intra-urban Migration'. Geographical Education, vol. 2, no. 1, pp.75-87.
- WHITELAW, J.S. and GREGSON, J.S. (1972) 'Search Procedures in the Intra-urban Migration Process'. Monash Publications in Geography, No. 2

- WHITELAW, J.S. and ROBINSON, S. (1972) 'A Test for Directional Bias in Intra-urban Migration'. New Zealand Geographer, vol. 28, no. 2
- WILSON, M.G.A. (1968) Population Geography. Nelson's Australasian Paperbacks, Melbourne.
- WOLPERT, J. (1965) 'Behavioural Aspects of the Decision to Migrate'. Papers of the Regional Science Association, vol. 15, pp. 159-169.

CHAPTER 2

THIS PRESENT STUDY - AIMS AND IMPLEMENTATION

The total network of flows (in intra-urban migration) has received almost no study ... with the result that a valuable source of insight into the way in which cities undergo change has been neglected.

MOORE (1969b, p.114)

OUTLINE

The major aims of this research project are stated and then followed by a listing of specific questions for investigation. Advocacy of the holistic view of the city as an organic unit leads to the decision to take the boundaries of the study area beyond the official urban limits. As defined it is the Adelaide Statistical Division. Sources of relevant data and some associated problems are discussed along with their planned usage. This is followed by an outline of the entire thesis chapter by chapter emphasizing the use of data and procedures rather than findings which are discussed in the context of the relevant chapters.

CHAPTER 2. THIS PRESENT STUDY - AIMS AND IMPLEMENTATION

CONTENTS

	Page
2.1 AIMS AND OBJECTIVES	34
2.1.1 Summary of Major Intent	34
2.1.2 Specific Questions for Investigation	34
2.1.3 Some Possible Outcomes	35
2.2 THE WHOLE CITY AS A UNIT OF STUDY	35
2.2.1 To Sample or Not to Sample	37
2.2.2 The Selection of an Outer Boundary	41
2.3 SOURCES OF DATA	42
2.4 OUTLINE OF USES MADE OF THE DATA - AN OVERVIEW OF THE THESIS	48
2.4.1 Indirect Evidence of Population Movement (Chapter 3)	48
2.4.2 Movement Indices, Active Links and Mover- stayer Analysis (Chapter 4)	49
2.4.3 The City as a Matrix - Flows, Linkages and Volumes (Chapter 5)	50
2.4.4 Distances of Outmovement (Chapter 6)	50
2.4.5 Directions of Outmovement (Chapter 7)	51
2.4.6 Comparison of Selected Population Characteristics and Movement Parameters (Chapter 8)	51
2.4.7 A note on the Use of Correlation Coefficients in this Study	52
REFERENCES	57

CHAPTER 2. THIS PRESENT STUDY - AIMS AND IMPLEMENTATION

LIST OF FIGURES

		Page
2.1	Location of study area	facing p. 34
2.2	The study area: Adelaide Statistical Division	facing p. 42

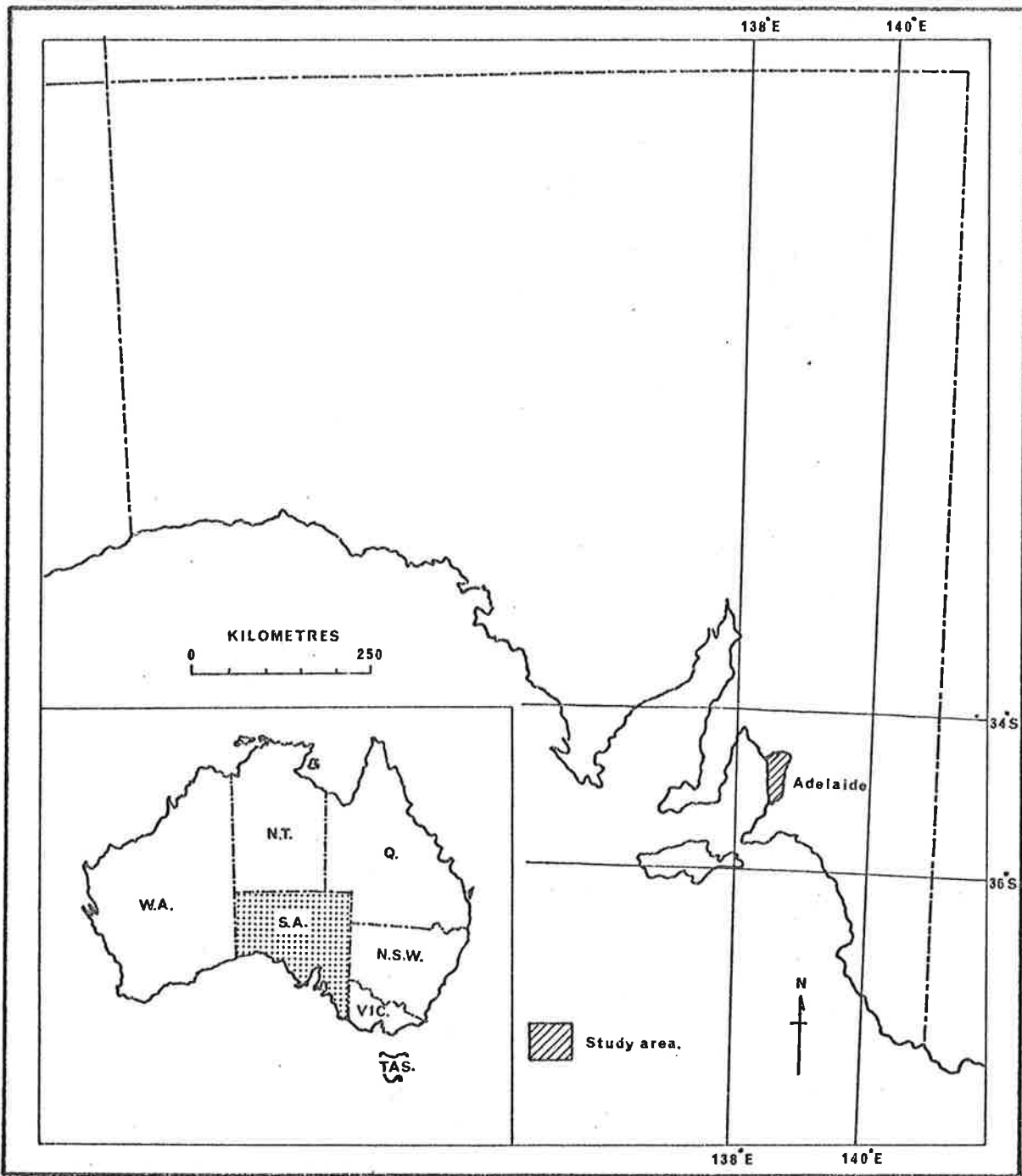

FIG. 2. 1. Location of Study Area.

CHAPTER 2. THIS PRESENT STUDY - AIMS AND IMPLEMENTATION

The classification scheme derived from Moore (1966a) and Whitelaw (1972), and used in Chapter 1 for review of previous studies in intra-urban migration, provides a ready base from which to introduce the present study. In those terms the essential characteristics of the study are that it is descriptive in basic intent, 'macro' in spatial scale, with a time span of fifteen months for the movement data. The urban area to be the subject of study is the city of Adelaide, capital of the state of South Australia (see accompanying map, Fig. 2.1) the total population of which at the last census (June 30, 1971) was 842,693 (Aitchison, 1973, p,115).

2.1 AIMS AND OBJECTIVES

2.1.1 Summary of major intent:

The following are the broad general aims of this study.

- a. To describe for Adelaide the dimensions and spatial characteristics of intra-urban migrations which have occurred during a selected period.
- b. To seek for likely explanations of the observed spatial distributions of intra-urban migration by relating the patterns discovered to selected population characteristics and to existing theory on residential change in urban areas.

2.1.2 Specific questions for investigation:

- a. What are the individual and aggregated characteristics of

movements resulting from change of place of residence within the Adelaide urban area?

This necessitates identification of places where movements originate and terminate, measures of volumes of movers and the distances and directions of movements.

- b. What spatial patterns can be discerned in the collective residential movements in the general population?
Hopefully, identified 'patterns' are amenable to generalization and prediction.
- c. To what extent is the socio-economic status of sub-areas of the city maintained or changed through intra-urban migration?

2.1.3 Some possible outcomes:

Such a study might be expected to have at least the following two practical outcomes in broad planning terms. Firstly, the identification of "hearth areas": there are areas of major population outflow which experience net out-migration and are therefore sources of supply of population to areas of net in-migration. Secondly, the identification of areas undergoing social change through replacement of some of their people with others of different characteristic.

2.2 THE WHOLE CITY AS A UNIT OF STUDY

The ancient story of three blind men exchanging apparently irreconcilable "views" as they explored different parts of the same elephant emphasizes the immense value of possessing an overall view

before gathering detail. Schnore (1966) has written a summary of the diverse ways in which the city may be viewed as an entire social organism. He points out that though much is known of certain internal structures and operations of cities, least is known about what he calls "cellular turnover" (Schnore, 1966, p.62) in which he includes "the appearance and disappearance of households and firms, the entry and exit of individual cells". He goes on to argue the paramount importance of "context" in the understanding of an organism, even one so complex as a city. Other writers such as Moore (1966b) consider the city as a "system" of interlocking and overlapping forces. These notions have helped to confirm a view already held by this writer that the migratory movements which are at the core of this study should be viewed in the broadest possible city-wide context.

Intra-urban migratory movements have never been described before for the entire Adelaide area. Although residential movements of segments of the population have been described by Gibson (1967), Chugg (1971) and Griffiths (1973) there are no ready means by which rapid representation might be given to even a sample of moves within the city-wide situation. Individual moves, the ultimate in micro-level studies, can be seen in perspective only as parts of the whole intra-urban migration context. The least that can be claimed for the holistic view is that studies of the individual urban decision maker, his motivation and the social aspects and implications of migratory choice are much enriched if viewed within the total urban context and with an overall view of

movement patterns.

The severe lack of studies on the total network of intra-urban flows has led to the neglect of a valuable source of insight into the way in which cities undergo change (Moore, 1969b, p.114). To achieve studies of this kind it is apparent that there is a need for regular, consistent measures of area-to-area population movement (Simmons, 1968, p.649). The case for attempting in this way the total view of a single system of intra-urban migration has been expressed clearly in the following terms (Simmons, 1968)

"The development of models which will explain and predict patterns of flow and, hence, spatial change within the city will require the full flow matrix, identifying flows from every spatial subdivision of the city to every other subdivision"

(As revised and reprinted in Berry and Horton, 1970, p.409)

The obvious first step in meeting the commitment to a total-view is the securing of a supply of reliable data able to yield the required basic description of movement patterns over the entire city. Although there is the likelihood of severe logistical problems in so large an exercise a more important problem is the choice of suitable measures. In this regard it has been observed by Wolpert (1967, p.605) that "recognition has been given to the need for development of more suitable descriptive tools for measuring the migrational streams themselves".

2.2.1 To sample or not to sample.

It has been pointed out by Johnston (1973b) that variation in

size and shape of official statistical units predisposes data collected from them to certain biases. The idealistic desire to avoid such bias would seem to be satisfied by taking population data for precise individual residential addresses of movement origins and destinations thereby escaping the need to use arbitrary official boundaries. Accordingly, data gathering for this project was worked into a practical recording and processing procedure on this basis. Nevertheless it was soon realized that this threatened to take unwarranted time to complete and that it was necessary to accept whichever official statistical areas could provide suitable aggregated data instead of allowing 'natural clusters' to emerge from the processing of the records.

Sampling in some form or other would seem, however, to offer a possible solution to the problem of achieving a city-wide coverage with the limited resources and time available. Therefore various schemes for sampling movement within the study area were examined. All, however, suffered such deficiencies as to force the conclusion that there was no satisfactory alternative to a full coverage of the whole city.

Firstly, for example, spatial sampling was considered. A system used in Melbourne by Johnston (1966, p.164) and based on that used in Chicago by McElrath and Barkey (no date) involved stratified sampling of census collector's districts (C.Ds) along radials from the central business district (C.B.D.). Seventeen radials, three sectors and four concentric zones were defined.

From the 438 C.Ds cut by the radials a twentyfour percent random sample (n=105) was drawn. Pryor (1967) followed the same general procedure in his study of Melbourne's urban and rural fringes, utilizing two radial sectors and random numbers to locate sampling points (houses) at distances along seventy radials. Sampling of the kind represented by these studies is able to yield sound information about urban morphology and the spatial distribution of population characteristics based on census C.Ds. However, such a geometric sampling structure would seem far too restrictive for a study of population movement, particularly when sources additional to the census are essential. It is especially limiting and liable to introduce a predetermined spatial bias of unquantifiable dimensions when movement data is only available for say fifty very uneven spatial cells instead of the thousand or more for census data. The real crux of the present matter is deciding what it is that is to be sampled. Because residential movement is the subject of study it is 'movement' itself or the 'movers' which should be spatially sampled. However the spatial distribution of these attributes being yet unknown is one of the main objects of this research and therefore must first be identified by means other than sampling.

A second category of sampling which seemed worthy of consideration consists of drawing a predetermined number of persons from a list, say, of movers. In this case it would involve obtaining for each 'cell' of the city a list of the names of persons who had moved either in or out during a given time. The details of place

of origin or destination would be plotted for only a sample from each cell. However, as discussed later, it was found that the cells of the local data source varied so greatly in both area and numbers of persons that a single uniform sampling proportion could not be applied validly to them all. Furthermore, whether the names were drawn from master lists randomly or systematically, but with equal disregard for residential location, there seemed to be no good reason to expect that the locations of the residences would be so spaced as to enable valid conclusions to be drawn about the spatial character of the movement patterns.

It seems then that spatial sampling can assist in describing spatial distributions of population characteristics but not movement, that list sampling within cells can yield information about a population but without reference to the internal spatial distribution for which spatial homogeneity has to be assumed. To make this assumption outright without either knowing or testing the extent of variation from the assumption is clearly unwise. To test the assumption in the Adelaide case is in itself a difficult and large task because no basic parameters of movement are yet available, having not been the subject of previous research. The total size of the parent population of movers, the distribution and density of their origins or destinations and the dimensions of their moves are all unknown. To compile maps and statistics of flows by means of random or systematic sampling of official lists of movers would run the risk of introducing unquantifiable spatial bias.

"A proper sample should be a small piece of the population obtained by a probability process that mirrors, with known precision, the various patterns and subclasses of the population." (Lazerwitz, 1968, p.279)

A clear statement of the spatial distribution of rates of residential movement and associated patterns for the whole city of Adelaide is a logical necessity for the achievement of which there appear to be no satisfactory 'short cuts'. It is only with such a description that parts can be studied as known fractions of a whole, and samples taken with better logic to provide for more detailed analysis. The difficulties encountered in reaching this position have been noted by other workers in urban migration, for example Moore (1969b, p.114)

"The basic issue of what constitutes an appropriate partitioning of a city for purposes of migration analysis has not been seriously broached."

2.2.2 The selection of an outer boundary.

With acceptance in principle of commitment to a study involving the total urban area of Adelaide there was the practical problem of determining an outer boundary for the study. In some places contiguous urban development extends well beyond the official census limits to the metropolitan urban area. These limits result from population density criteria (Linge, 1965) the application of which has been criticised by Marsden (1969). The administrative boundary found most suitable for the present purpose was that of the Adelaide Statistical Division (A.S.D.) a unit used by the Australian

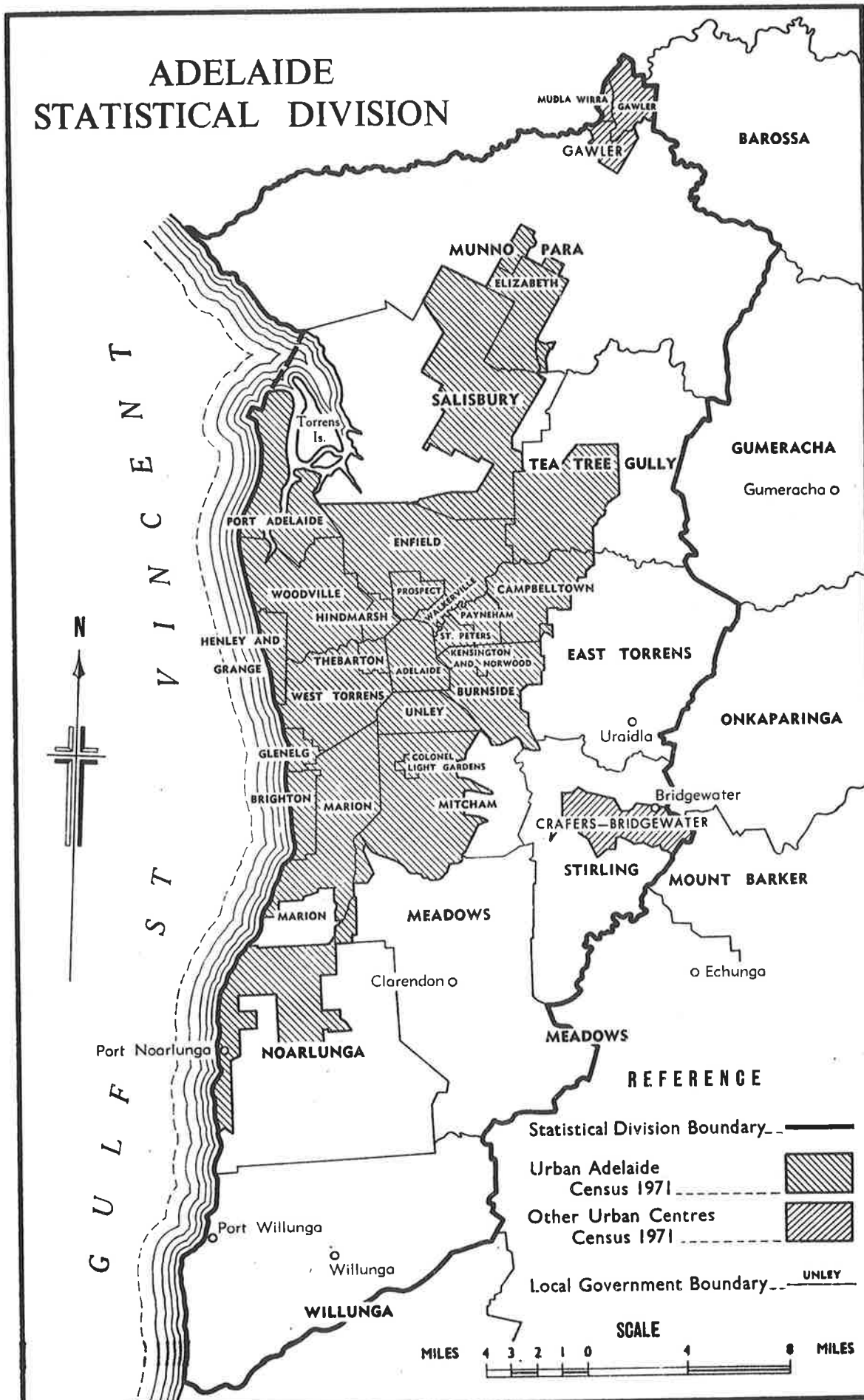

FIG. 2.2: The study area: Adelaide Statistical Division. Source: South Australian Year Book, 1972, p. 111.

Bureau of Statistics (A.B.S.) and shown on the accompanying map (Figure 2.2). All census data is available for the area as a single unit and for areas within it made up of the basic building blocks of census collector's districts (C.Ds).

Throughout almost its entire length, apart of course from the western coastline, the boundary of the Adelaide Statistical Division traverses land whose chief use is easily identifiable as rural or rural-urban (See Pryor, 1968c). The land-use maps of "Report on the Metropolitan Area of Adelaide" (Adelaide, 1962) confirm this, but the passing of a decade since their compilation reduces their credibility as the sole basis for such judgement. Nevertheless, personal familiarity with the area indicates no great error in following this classification. It is clear therefore, that by taking this particular geographic limit to the study area, the city in its physical, spatial entirety has been included with varying amounts of adjacent peripheral lands whose populations, though perhaps not fully urban, can be expected to exhibit characteristics attributable in part at least to proximity to the urban area.

2.3 SOURCES OF DATA

"Preliminary to the establishment of generalizations about dimensions of migration streams, there must be the development of efficient parameters for describing these flows"

WOLPERT, 1967, p.605

Nevertheless it has been observed that in pursuing empirical research at the aggregate level the main problem is the acquisition

of suitable data - "in itself ... a major research task which could form the basis for much subsequent work" (Moore, 1969b, p.114).

It is often the case in population studies that it is the availability and source of data rather than idealism which ultimately determines the form of the data utilized (Simmons, 1968, p.649; Moore, 1970, p.15). The present study is no exception. Willis (1968) in the United Kingdom and Moore (1969b) in Queensland are in general agreement with the view expressed in South Australia by Hugo (1971, p.278) that despite important limitations "electoral register transfer data ... is the best available inventory of gross patterns of movement". Accordingly this became the major source of information for this study.

The content and operation of the South Australian electoral rolls and their computer maintenance as well as methods of use in the study of population movement are described in the next chapter (Sections 3.7 and 3.8) and Ward (1975). Their major limitation for this study arises from the laws governing eligibility of persons to appear on the rolls, despite compulsory registration. Eligible persons are aged at least 21 years (since March 1973 includes all over 18 years) and British subjects (i.e. by birth or naturalization are Australian citizens or citizens of any member country of The Commonwealth of Nations) who having lived in Australia for a minimum period of six months "are not of unsound mind, convicted and under sentence for any offence punishable by imprisonment for one year or longer, attainted of treason or holders

of temporary permits under the Migration Act" (Aitchison, 1969, p.50. A rewording of C.E.A., Part VI, ss.39). These rules thus exclude from the rolls unnaturalized foreign born and persons under 21 years of age, although since March 1973 persons aged between 18 and 21 have been permitted voluntary enrolment.

In the Adelaide Statistical Division at the 1971 census, foreign born constituted 28 per cent of the population. Adult aliens on the other hand were estimated by A.B.S. at December 1972 to number 40,000 in the entire State and would therefore comprise approximately 3½ per cent only of the population in the study area, although it seems probable that they are a larger percentage than this of the adult population. Because they are not an insignificant section of the population, their unavoidable exclusion from the study through lack of recorded data is regrettable and to this extent the findings fail to apply to the entire city. This problem is discussed in more detail in Chapter 3 (Sections 3.5 and 3.6). The exclusion of persons under 21 years is not quite so serious because most of them reside with parents and their residential movements are generally the same as their parents who do appear on the electoral rolls. However, it is widely acknowledged that increasing numbers of people under 21 years after leaving school are living independently of their parents. Unfortunately their exclusion from the rolls prevents any check on this trend or the mobility of this section of the population. This is of course another significant though hopefully small loss.

A limitation on the time span of data on residential movement was another consequence arising from the choice of electoral rolls as prime source. In March, 1970, a major electoral redistribution was completed which for practical purposes meant that movement before and after this date could not be compared effectively by subdivisions. The decision was made therefore to begin collection of movement data from March 1970. As is explained in section 3.7, the life of each roll and its cumulative supplements is terminated upon amalgamation into a new roll at the time of periodic "up-date". With four up-dates in a short time after March 1970 the most convenient end point for the movement study was June 11, 1971 when an up-date almost coincided with the census of June 30, 1971. This provided movement data on electors for a fifteen month period and through the census a contemporary profile of the total population. The fifteen months of analysis can be viewed as only "a moment in time" in the development of the Adelaide urban area. The time span was clearly too short to provide reliable indicators of changes in movement patterns over a longer period, nor is there direct evidence of whether the annual rates described are consistent with longer term trends of increase or decrease or even if whether the particular rates are typical of residential change during a longer period. These are all important features needing further research.

The basic areal units used in the maintenance of the joint rolls by the State Electoral Department and the Commonwealth Electoral Office are known as subdivisions and discussed in the next chapter (section 3.7). The territory comprising Adelaide Statistical Division contains forty-six full subdivisions and parts

of four large rural subdivisions (see Figure 3.16).

To maintain comparability of areas between data from different sources, it was decided to include the appropriate sections of the four rural subdivisions, although this could only be achieved by separate manual compilation of data for the four parts on the basis of the constituent postcode areas. This brought the total of spatial cells in the study area to fifty and these are the geographic statistical units between which migratory flows are seen to occur and they are the units upon which further analysis and discussion is based.

The following is a summary listing of the kinds of information gathered for this study from the South Australian Electoral Rolls for the fifteen months from March 1970 to June 1971 for each of the fifty electoral subdivisions comprising the Adelaide Statistical Division:

- the total number of electors on the roll
- the number deleted from the roll as deceased, moved interstate, transferred to another specified subdivision, or miscellaneous reasons
- the number added to the roll
- the number whose entry has been amended, especially having transferred within the subdivision.

The meaning of the terms and use made of the data is discussed in sections 3.8 and 4.3.

A second important source of information was the Australian

Bureau of Statistics (A.B.S.), formerly the Commonwealth Bureau of Census and Statistics. Succeeding chapters make use of selected data from censuses held on 30th June 1961, 1966 and 1971. To enable comparison of data drawn from the census with that from electoral rolls, census collector's districts (C.Ds) were amalgamated to cover the same territories as each electoral subdivision. The procedure and the results are discussed in later chapters (see section 3.5).

A third source of information was the Commonwealth Department of Immigration which supplied the number of aliens who during the study period became naturalized citizens and thus electors.

In an effort to generate an index of dwelling turnover for both owner and tenant-occupied houses, several other promising sources were investigated. It was anticipated that profitable comparison would be made between rates of dwelling turnover and population turnover. It was reasoned that measures of dwelling turnover would not be subject to the same selective biases as would measures of population turnover and could be, therefore, a useful supplement. Promising though this line of investigation appeared, it was discontinued because it was desperately cumbersome and time consuming even by comparison with manipulation of the electoral rolls. It may however become more practicable in the not too distant future now that the S.A. Lands Title Office and the Valuation Department keep continuous computer files of all property sales.

2.4 OUTLINE OF USES MADE OF THE DATA - AN OVERVIEW OF THE THESIS.

The following is an outline, chapter by chapter, of the contents of the remainder of this thesis.

- 2.4.1 Indirect evidence of population movement - gross and net population changes. (Chapter 3)
- 2.4.2 Movement indices, active links and mover-stayer analysis. (Chapter 4)
- 2.4.3 The city as a matrix - flows, linkages and volumes (Chapter 5)
- 2.4.4 Distances of out-movement. (Chapter 6)
- 2.4.5 Directions of out-movement. (Chapter 7)
- 2.4.6 Comparison of selected population characteristics and movement parameters. (Chapter 8)
- 2.4.7 A note on the Use of Correlation Coefficients in this Study.

2.4.1 Indirect evidence of population movement (Chapter 3).

Analysis begins with Local Government Areas for which indirect evidence of population movement consists of annual rates of net migration derived from total population change and natural increase over the two intercensal periods 1961 to 1966 and 1966 to 1971. This reveals a roughly concentric zonation resembling the well-known model by Burgess (1925).

Following the selection of electoral rolls as the major data source there is a test of its ability to measure population change

in comparison with the census for standard areas. The two measures are statistically well-matched over the entire city although there are important internal spatial differences.

Further evaluation of the electoral rolls themselves reveals some apparent anomalies in the proportions of eligible persons actually registered. Careful analysis shows that despite considerable spatial variation registration rates are high and apparently reliable.

Finally there is an outline of the characteristics and operational procedures of the computer-maintained S.A. electoral rolls. The source of data on residential movement is identified as the subdivisional cumulative lists of 'transfer-deletions' and internal 'amendments'.

2.4.2 Movement indices, active links and mover-stayer analysis (Chapter 4),

The formulae described by Moore (1969a, and 1971) and applied by him in Brisbane, are utilized to calculate indices for elector change in each subdivision in terms of annual net migration and annual population turnover. The ranking, classification and mapping of the indices provides a basis for development and discussion in later chapters. The 1971 census provides the information on which a mover-stayer ranking of subdivisions is made. The electoral rolls reveal that not all the possible links between subdivisions are utilized by transferring electors so that there are active and inactive links.

To enable distances and directions to be applied to the movement flows between subdivisions and discussed in later chapters, centroids are allotted to each subdivision. Because subdivisions are so varied in size and population density, the centroids are weighted according to the actual location and population numbers as recorded in the constituent census collector's districts. It is then assumed that on average aggregated moves between subdivisions begin and end at the centroids and take place effectively over the straight line connecting the two points. The distances and directions between points are calculated by trigonometry based upon the coordinates of the map grid.

2.4.3 The city as a matrix - flows, linkages and volumes (Chapter 5).

A fifty by fifty matrix representing each electoral subdivision as both origin and destination is the framework for recording all intra-urban outmovements of electors. The flows for the whole study area are ranked by volume and the largest one hundred are mapped. They reveal various regional clusterings or preference zones with flows and counterflows of almost equal strength.

2.4.4 Distances of outmovement (Chapter 6)

Based upon the number of movers transferring along each route from Chapter 5 and the distance between centroids in Chapter 4 it is possible to compile a distribution of distances moved and a mean distance of outmovement for each subdivision and the whole study area. The rate of fall-off in numbers moving with increasing distance from the origin is plotted. Distance moved is also plotted

against distance of the point of origin from the city centre.

2.4.5 Directions of outmovement (Chapter 7).

This chapter uses the same basis as the previous one - numbers of outmigrants along linkages between centroids but direction moved instead of distance. An established procedure is followed of taking the city centre as the point of reference for measuring direction moved - 0 degrees toward the C.B.D. and 180 degrees toward the urban periphery. Summary tables are prepared and generalization made in terms of a "dominant direction" for each subdivision and an index of concentration of outmovement. Both these are checked for variation with distance of the origin from the city centre and length of move.

2.4.6 Comparison of selected population characteristics and movement parameters (Chapter 8).

Multiple correlation coefficients (for the whole Adelaide Statistical Division) are calculated for twenty-eight selected census and movement variables and applied to group linkage analysis according to models described by Coulson (1968) and Moore (1969a). This leads to the isolation of four main variables which appear to be significantly associated with rates of movement. This suggests aspects of residential change to be examined in future research into the causes of population movement.

2.4.7 A Note on the Use of Correlation Coefficients in this Study.

The descriptions and arguments of this thesis are suspended on a continuous thread of numeric information gleaned from the two main sources already named. Frequently the development of the discussion requires the comparison of two or more sets of related data with the attendant need to determine objectively the extent of their statistical similarity. In this study the measure most frequently applied to this end is that known as the 'coefficient of correlation', usually Pearson's and occasionally Spearman's, depending upon circumstances. In general, such measures are most commonly used with samples and certain assumptions inherent in their statistical design have implications for the interpretation of the results obtained from their use. It is appropriate, therefore, that this introductory overview, in addition to the preceding descriptive sequence, should also include a preview and justification of the main tool employed in the numeric analysis of the data upon which the thesis is based.

The correlation coefficient is described by Yeates (1974, pp. 86-87) as an index measure of the strength of the linear association between two variables or "the degree of linearity of the scatter of points". It is an appropriate indicator to use according to Hays (1974, p.669) whenever the purpose is to predict "an individual's status on one trait from his status on another in some 'natural' population". Although this is the general sense in which the correlation coefficient is applied in this thesis, it is used more particularly as an objective means of describing the kind

of numeric relationship between variables, rather than for the direct purpose of prediction. Initially it is used to show that data measuring substantially the same phenomenon, but gathered from two different sources, yield results so alike as to make credible the use of either source but more especially the less common one. In another section, two categories of information from the same source on electoral transfers are compared by correlation analysis. In the final stage the distance and direction characteristics of intra-urban residential movement are compared by correlation coefficient, not only with each other, but also with such other variables as distance of origin from the C.B.D. and indices of annual movement rates. Finally, in an effort to find statistical indicators for rates of both population turnover and net migration, a correlation matrix is compiled and analysed involving a selection of population and housing parameters in addition to the movement indices.

In the present study the 'population' to which correlation analysis is usually applied is the fifty electoral subdivisions of the Adelaide Statistical Division. For each subdivision the variables are paired data sets consisting of either measures on two different characteristics, or the same characteristic measured by two different sources, or alternatively, the same measure, from the same source but at two different times. In every case the data is parametric in nature (Siegel, 1956, p.2) and expressed in terms of either interval or ratio scales (Blalock, 1972, pp.15-20). The data is amenable, therefore, to application of the almost universal

Pearson Product-moment Coefficient of Correlation (r) which is used, in most cases, in this present study. However, a problem which arises from the particular way in which this data is distributed, makes it sometimes desirable to use the Spearman Rank Correlation Coefficient which is designed for use with ordinal scales (Blalock, 1972, pp.415-418).

The fifty electoral subdivisions display considerable individual differences in size of population (see Table 3.3) a few being as small as one-tenth the size of the largest ones. Therefore, even though most subdivisions are similar in size, taken together they cannot be considered a homogenous population, neither can their distribution be seen as linear nor normal. Both of the latter two attributes are considered by statistical idealists to be essential in data submitted to correlation analysis (Poole and O'Farrell, 1971, p.156; Johnston, 1971a, p.320; Gould, 1970, p.442). As pointed out by Blalock (1972, p.381) the correlation coefficient is highly affected by a few extreme values of either variable and the range of variability is of great importance in determining the actual level of the coefficient. A common practice to obviate this difficulty is 'transformation' of the data to linear-normal, by various means, to make them amenable to standard tests. Although this procedure seems an appropriate step in the present circumstances resources available have made its use impossible. In a smaller and less general way some allowance for the influence of extreme absolute values in interval or ratio distributions may be achieved by analysing the rank positions, instead of the raw scores or indices, thereby disregarding

the absolute intervals between scores. This, of course, considers the data at a lower level of measurement where it is amenable to analysis by the Spearman Rank Correlation. As indicated by Blalock (1972, p.426) and Siegel (1956, p.213) the application of the two coefficients to the same linear-normal distribution yields very similar results. Presumably, where calculation of the two coefficients on the same data, yields appreciably different results this is attributable to departures in the distribution of the original data from the assumptions of normality and linearity. For example, in the process of ranking interval data, distortion of absolute differences is introduced, the degree of distortion depending upon the original variation in the magnitude of differences. Some individual cases will have their differences exaggerated by being made to appear more unlike their nearest neighbours, while others will appear less different than they really are. In this present study there are several examples where both the Pearson and Spearman Correlation are calculated in an effort to indicate the relative influence of either or both, extreme values and the non-linearity-normality of the data. Furthermore, in most cases a scattergram is provided to indicate the nature of the problem, a procedure commended by Blalock (1972, p.381).

On a few occasions, discussion of subdivisional data centres on changes over time of relative position or ranking of subdivisions rather than absolute change in scores. In such circumstances it is entirely appropriate to employ the Spearman Rank Correlation Coefficient.

In common with other techniques of statistical analysis, measures of correlation are typically applied to sample data which are linear-normal (Gould, 1970, p.442). The problems of interpretation involving levels of probability, significance and degrees of freedom stem from the usual need to extrapolate to specified total populations the results obtained from analysis of samples drawn from the same population. In the present case, the use of sampling has been rejected (section 2.2.1) and therefore the data to be analysed is gathered from a well-defined total population. That it would be logically absurd to apply the 'standard' inferential tests of significance to analysis of a total population has been remarked upon by Gould (1970, p.442). The purpose of the tests, of enabling projection of results onto a larger parent population, cannot be achieved in the paradoxical situation where sample and population are identical. Given that the intention of the present study is to use its data descriptively,

"it is not necessary to make any assumptions at all about the form of the distribution, the variability of Y scores within X columns or 'arrays', or the true level of measurement represented by the scores in order to employ linear regression and correlation indices to describe a given set of data" Hays (1974, p.636)

Under these circumstances the data is described as though a linear rule were to be used for prediction and it is now agreed that this is a "perfectly adequate way to talk about the tendency of these numerical scores to associate or 'go together' in a linear way in these data" (Hays, 1974, p.636). In the interest of preserving comparability, levels of significance and degrees of freedom are shown as accompaniments of all statements of correlation coefficients.

REFERENCES

- ADELAIDE (1962) Report on the Metropolitan Area of Adelaide. S.A. Government Printer, Adelaide, S.A.
- AITCHISON, D.L.J. (1969) South Australian Year Book, No. 4. Commonwealth Bureau of Census and Statistics, S.A. Office.
- BLALOCK, H.M. (1972) Social Statistics, McGraw-Hill, Tokyo.
- BOURNE, L.S. (1971a) (ed.) Internal Structure of the City. Readings on Space and Environment. Oxford University Press, New York.
- BOURNE, L.S. (1971b) 'Physical Adjustment Processes and Land Use Successions. A Conceptual Review and Central City Example'. Economic Geography, vol. 47, no. 1, pp.1-15.
- CHUGG, D.R. (1971) 'Population Change and Intra-urban Migration in Adelaide, 1961-70'. Unpublished thesis, Geography Dept., University of Adelaide.
- CLARK, W.A.V. (1970) 'Measurement and Explanation in Intra-urban Residential Mobility'. Tijdschrift Voor Econ. En. Soc. Geog., vol. lxi, no. 1, pp.49-57.
- Commonwealth Electoral Act, 1918-1966. 1 July, 1971.
- COULSON, M.R.C. (1968) 'The Distribution of Population Age Structures in Kansas City'. Annals, Association of American Geographers, vol. 58, no. 1, pp. 155-176.
- Electoral Act, 1929-1969 (State of South Australia). Reprinted 3 August, 1970.
- GIBSON, J.G. (1967) 'The Residential Pattern and Mobility of Dutch and Greek Migrants in the Adelaide Metropolitan Area'. Unpublished thesis. Dept. of Geography, University of Adelaide.
- GOULD, P. (1970) 'Is Statistix Inferens the Goographical Name for a Wild Goose?'. Economic Geography, vol. 46, no. 2 (Supplement), pp. 439-448.
- GRIFFITHS, K.R. 'The Effects of Relocation: A Reappraisal of Acquisition'. Unpublished thesis, Dept. of Geography, University of Adelaide.

- HAYS, W.L. (1974) Statistics for the Social Sciences, (2nd edition), Holt, Rinehart and Winston, London.
- HUGO, G.J. (1971a) 'Internal Migration in South Australia 1961-1966'. Unpublished thesis, Dept. of Geography, Flinders University, S.A.
- JOHNSTON, R.J. (1966a) 'The Location of High Status Residential Areas'. Geografiska Annaler, vol. 48 (Series B), no. 1, pp.23-35.
- JOHNSTON, R.J. (1966b) 'Residential Structure and Urban Morphology'. Unpublished Ph.D. thesis, Dept. of Geography, Monash University.
- JOHNSTON, R.J. (1966c) 'The Population Characteristics of the URBAN Fringe: A Review and Example'. Australian and New Zealand Journal of Sociology, vol. 2, no. 2, pp. 79-93.
- JOHNSTON, R.J. (1971a) 'Some Limitations of Factorial Ecologies and Social Area Analysis'. Economic Geography, vol. 47, no. 2 (Supplement), pp.314-323.
- JOHNSTON, R.J. (1973b) 'On Frictions of Distance and Regression Coefficients'. Area, vol. 5, no. 3, pp. 187-191
- LAZERWITZ, B. (1968) 'Sampling Theory and Procedures'. In Methodology in Social Research. Edited by Hubert M. Blalock, Jr and Ann B. Blalock, McGraw-Hill, New York, pp. 278-328.
- LINGE, G.J.R. (1965) The Delimitation of Urban Boundaries. The Australian National University, Research School of Pacific Studies, Dept. of Geography Publication G/2.
- MARSDEN, B.S. (1969) 'A Critique of the Urban Delimitation Concepts in the 1966 Commonwealth Census'. Australian Geographer, vol. xi, no. 1, pp. 73-78.
- MOORE, E.G. (1966a) 'Models of Migration and the Intra-urban Case'. Australian and New Zealand Journal of Sociology, vol. 2, no. 1, pp. 16-37.
- MOORE, E.G. (1966b) 'Residential Mobility in an Urban Context: A Systems Approach'. Unpublished Ph.D. thesis, University of Queensland.
- MOORE E.G. (1969a) 'The Structure of Intra-urban Movement Rates: An Ecological Model'. Urban Studies, vol. 6, no. 1, pp. 17-33.

- MOORE, E.G. (1969b) 'The Nature of Intra-urban Migration and Some Relevant Research Strategies'. Proceedings of the Association of American Geographers, pp. 113-116.
- MOORE, E.G. (1970) 'Intra-urban Residential Mobility and Urban Spatial Structure'. In Population and Migration in an Urban Context: A Spatial Perspective. (Paper no. 1) Meetings of the Population Association of America.
- McELRATH, D.C. and BARKEY, J.W. (no date) 'Social and Physical Space: Models of Metropolitan Differentiation'. Cited by R.J. Johnston, 'Residential Structure and Urban Morphology', Unpublished Ph.D. thesis, Dept. of Geography, Monash University, 1966, p. 164.
- POOLE, M. A. and O'FARRELL, P.N. (1971) 'The Assumptions of the Linear Regression Model'. Institute of British Geographers, Transactions No. 52, pp. 145-158.
- PRYOR, R.J. (1967) 'City Growth and the Rural-urban Fringe'. Unpublished thesis, Dept. of Geography, University of Melbourne.
- PRYOR, R.J. (1968) 'Defining the Rural-urban Fringe'. Social Forces, vol. 47, no. 2, pp. 202-215.
- SCHNORE, L.F. (1966) 'The City as a Social Organism'. Urban Affairs Quarterly, vol. 1, no. 3, pp. 58-69.
- SIEGEL, S. (1956) Nonparametric Statistics for the Behavioural Sciences, McGraw-Hill, New York.
- SIMMONS, J.W. (1968) 'Changing Residence in the City - A Review of Intra-urban Mobility'. Geographical Review, Vol. 58, no. 4, pp. 622-651.
- WARD, B.J. (1975) 'The Use of Electoral Rolls in the Study of Internal Migration'. Australian Geographical Studies, vol. 13, no. 1, pp. 94-107.
- WHITELAW, J.S. (1972) 'Scale and Urban Migrant Behaviour'. Australian Geographical Studies, vol. 10, no. 1, pp. 101-106.
- WHITELAW, J.S. (1973) 'Intra-urban Migration'. Geographical Education, vol. 2, no. 1, pp. 75-87.
- WILLIS, J. (1968) 'Population Growth and Movement', Working Paper 12, Centre for Environmental Studies.

- WOLPERT, J. (1967) 'Distance and Directional Bias in Inter-Urban Migratory Streams'. Annals, Association of American Geographers, vol. 57, pp.605-616.
- YEATES, M. (1974) An Introduction to Quantitative Analysis in Human Geography, McGraw-Hill, New York.

CHAPTER 3

INDIRECT EVIDENCE OF POPULATION MOVEMENT - GROSS AND NET CHANGES

The spatial differentiation of residential attributes is largely the result of the cumulation of intra-urban moves. Unfortunately, the type of data available has caused urban research to focus on the static distributions instead of on the processes that generate urban patterns.

SIMMONS (1968, p.649)

OUTLINE

Analysis begins with Local Government Areas for which indirect evidence of population movement consists of annual rates of net migration derived from total population change and natural increase over the two intercensal periods 1961 to 1966 and 1966 to 1971. This reveals a roughly concentric zonation resembling the Burgess model.

Following the selection of electoral rolls as the major data source there is a test of its ability to measure population change in comparison with the census for standard areas. The two measures are statistically well-matched over the entire city although there are important internal spatial differences.

Further evaluation of the electoral rolls themselves reveals some apparent anomalies in the proportions of eligible persons actually registered. Careful analysis shows that despite considerable spatial variation registration rates are high and apparently reliable.

Finally there is an outline of the characteristics and operational procedures of the computer-maintained S.A. electoral rolls. The source of data on residential movement is identified as the subdivisional cumulative lists of 'transfer-deletions' and internal 'amendments'.

CHAPTER 3. INDIRECT EVIDENCE OF POPULATION MOVEMENT - GROSS AND NET CHANGES

CONTENTS

	Page
3.1 INTRODUCTION	69
3.2 ANALYSIS BY LOCAL GOVERNMENT AREAS	71
3.2.1 1961 to 1966	71
3.2.1.1 Total population change	72
3.2.1.2 Natural increase	73
3.2.1.3 Net migration	74
3.2.2 Comparison of Intercensal Population Changes, 1961-66 and 1966-1971.	76
3.2.2.1 General comparisons	76
3.2.2.2 Population change	76
3.2.2.3 Natural increase	77
3.2.2.4 Net migration	77
3.2.2.5 Summary	77
3.3 COMPARISON OF POPULATION CHANGES BY CENSUS C.D.'s AND L.G.A.s 1961-1966	79
3.3.1 Within L.G.A.s of Highest Growth Rate	80
3.3.2 Within L.G.A.s of Less Than Average Growth	80
3.4 SOME FURTHER QUESTIONS	82
3.4.1 The Need For Another Source of Data	83
3.5 COMPARISON OF DATA FROM L.G.A.s, C.Ds AND ELECTORAL S.D.s	86

		64.
		Page
3.5.1	Areas of Underestimate (Negative) by the Electoral Rolls	88
3.5.2	Areas of Overestimate (Positive) by the Electoral Rolls	90
3.5.3	Areas of General Agreement on Population Change	91
3.6	PERCENTAGE OF ELIGIBLES IN THE POPULATION WHO ARE ON THE ELECTORAL ROLL.	93
3.6.1	Search for Estimates of Error	95
3.6.2	In-Visitors as Inflators of Population Numbers	96
3.6.3	Out-Visitors, as Depletors of Eligible Population Numbers	96
3.6.4	Influence of Split Census Collector's Districts	98
3.7	FEATURES OF ELECTORAL REGISTRATION IN SOUTH AUSTRALIA	100
3.7.1	Categories of Electors	101
3.7.2	Problem of 'Time-lag'	102
3.7.3	Electoral Units	103
3.8	COMPUTER HANDLING OF SOUTH AUSTRALIAN ROLLS	105
3.8.1	Maintaining Electoral Rolls by Computer	106
3.8.2	Cumulative Lists	107
3.9	CATEGORIES OF DELETIONS	110
3.9.1	Distribution of all Deletions	111
3.9.2	Summary of all Categories of Deletions	111
3.9.3	Categories of Deletions	113
3.10	SUMMARY	115
	REFERENCES	118

CHAPTER 3. INDIRECT EVIDENCE OF POPULATION MOVEMENT - GROSS AND NET CHANGES

LIST OF FIGURES

Figure	Title	Page
3.1	Percentage population changes in Local Government Areas, 1961-1966 Population change Natural increase Net migration	facing p.70
3.2	Concentric zonation of local government areas in the Adelaide Statistical Division for discussion purposes	facing p.72
3.3	Comparison of L.G.A. rankings on rates of natural increase and net migration 1961-1966 1961-66 and 1966-71	facing p.74
3.4	Percentage population changes in Local Government Areas, 1966-71 population change natural increase net migration	facing p.76
3.5	Comparison of boundaries of Local Government Areas and electoral subdivision	facing p.85
3.6	Relationships between spatial units used in this study in analysis of population movement	facing p.86
3.7	Mean annual rate of net population change in electoral subdivisions, 1966-1971	facing p.87
3.8	Mean annual rate of net change in number of electors in electoral subdivisions, 1970-71	facing p.87

- 3.9 (1) Relative ranking of growth in electoral subdivisions measured by census and electoral rolls facing p.88
- (2) Frequency of ranking deviations of electoral change compared with census change
- 3.10 Ranking deviations of electoral change compared with intercensal change under p.88
- 3.11(1) Annual rate of naturalization in Local Government Areas, 1970-71 facing p.90
- (2) Percentage of adult aliens in adult populations of electoral subdivisions, 1971
- 3.12 Percentage of electors in total population in electoral subdivision, 1971 facing p.92
- 3.13 Comparison of spatial distributions of facing p.94
- (1) percentage of eligible persons registered on electoral rolls
- (2) percentage after adjustment to minimize anomalies
- (3) number of fragmented census collector's districts
- 3.14 Effect of "adjustment" on percentage of eligibles on electoral subdivision rolls under p.94
- 3.15 Flow within electoral offices of information lodged by members of the general public facing p.100
- 3.16 Electoral divisions, districts and subdivisions, Adelaide Statistical Division, 1970 facing p.104
- 3.17 Classes of transactions made in the maintenance of S.A. composite electoral rolls facing p.107

- 3.18 (1) Deletions percentage of mean electoral population deleted 12/3/70 to 11/6/71 facing p.111
- (2) Deletions (all categories) ranked by absolute scores
- (3) Transfers as a percentage of all deletions
- (4) Objections as a percentage of all deletions
- 3.19 Each subdivision, percentage of categories of deletions from electoral rolls, 16/3/70 to 11/6/71 facing p.112
- 3.20 Graphs showing for each subdivision and for each category of deletion the percentage of all deletions which are transfers, interstate, deceased, objections or miscellaneous under p.113
- 3.21 Maps showing facing p.113
- (1) Interstate moves as a percentage of all deletions
- (2) Deceased as percentage of all deletions
- (3) Miscellaneous as percentage of all deletions
- 3.22 Summary of population groups discussed and correlations between them 116

CHAPTER 3. INDIRECT EVIDENCE OF POPULATION MOVEMENT - GROSS AND NET CHANGE

LIST OF TABLES

Table	Title	Page
3.1	Population changes 1961-1966 and 1966-1971, Local Government Areas (L.G.A.s) Adelaide Statistical Division	facing p.71
3.2	Classification of Local Government Areas according to rankings on natural increase and net migration 1961-1966	75
3.3	Comparison of net changes in population of electoral subdivisions. Measured by Census Data (1966-1971) and Electoral Rolls (1970-1971)	under p.87
3.4	Percentage of eligible British Nationals registered as electors in non-metropolitan electoral divisions, June 1966	93
3.5	Percentage of eligible persons actually registered on subdivisional electoral rolls and adjustments to minimize anomalies	facing p.94
3.6	Comparison of S.A. electorates for Commonwealth and State governments	104
3.7	Comparison of S.A. electoral subdivisions, March 1970	105
3.8	Summary of all electoral deletions Adelaide Statistical Division, 16/3/70 to 11/6/71	112
3.9	Summary of Pearson's Correlation Coefficients between categories of deletions (absolute scores)	114

CHAPTER 3. INDIRECT EVIDENCE OF POPULATION MOVEMENT - GROSS AND NET CHANGES

3.1 INTRODUCTION

This chapter is based upon the consideration of two official sources of information on residential movement: firstly, the Australian Census, and secondly, the South Australian Electoral Roll. It is shown that though census data can be used to generate rates of net migration, more detailed analysis of local movement must be derived necessarily from other sources. The electoral roll is taken as the best available source despite its shortcomings. Considerable space is given to the problems of achieving spatial comparability of the two systems and levels of reliability of electoral data as measures of residential movement.

The most recent census (1971) was the first occasion that an Australian census sought information about the address of respondents at the previous census. This information is discussed in the next chapter (section 4.2). Despite the absence of this data from earlier censuses, it is possible to make inferences about the likely amount of new movement in a given area by comparing total changes in the population with levels of natural increase. Although this reveals whether movement in an area has been dominantly inward or outward, it is unable to provide information about either the volume of turnover of the population or of the places of origin or destination of migrants. Nevertheless as an initial exploratory device, the use of net migration analysis has merit particularly because it enables simple comparison between different study areas or times.

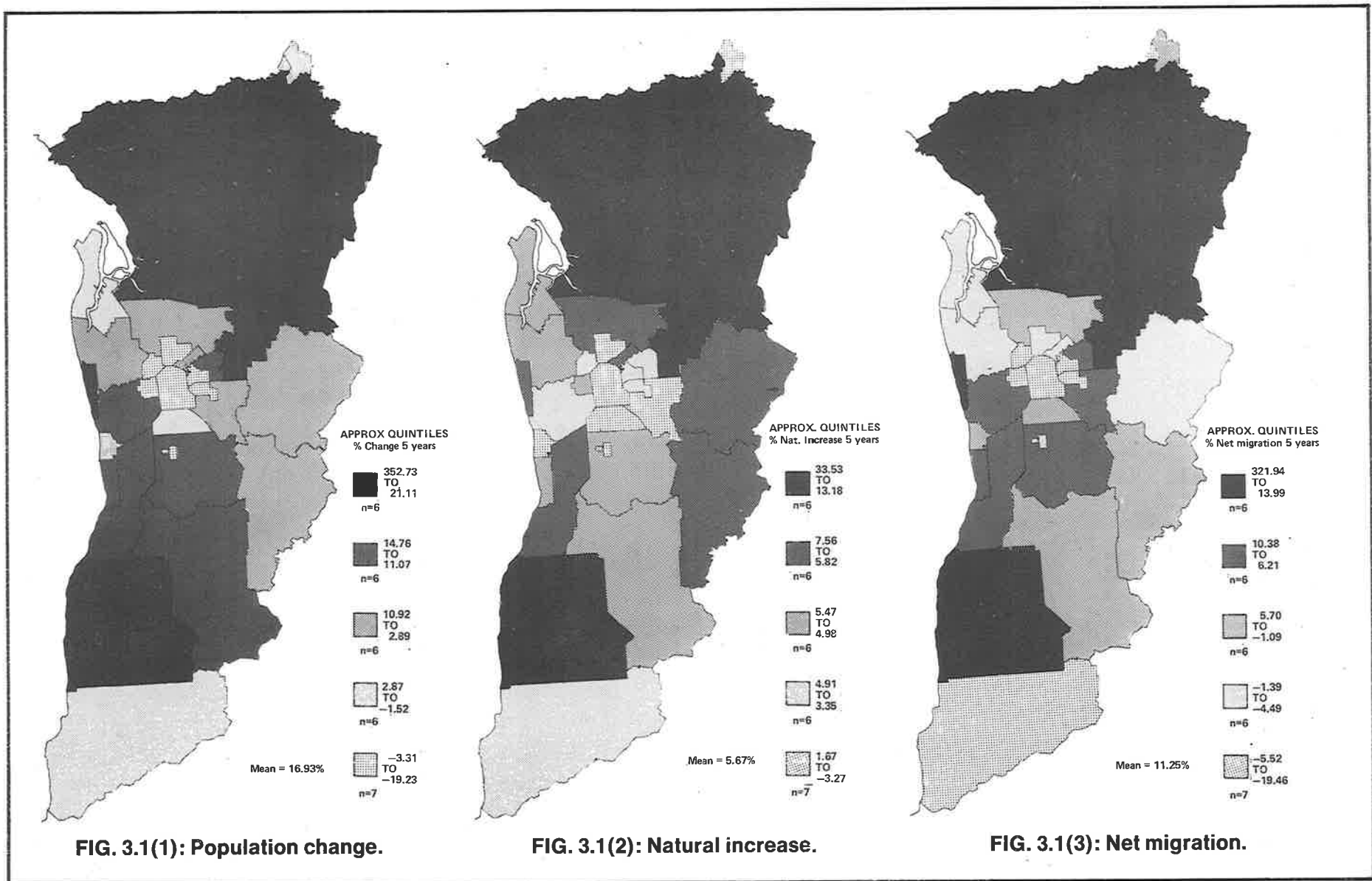

FIG. 3.1: Percentage population changes in Local Government Areas 1961-66. Source: Calculations based on data supplied by Australian Bureau of Statistics, Censuses 30th June, 1961 and 1966.

The following statement sets out the connection between the statistical elements involved.

$$\begin{array}{rcl} \text{Net change in} & = & \text{Natural increase} & + & \text{Net Migration} \\ \text{total population} & & (\text{Births} - \text{Deaths}) & & (\text{Inmoves} - \text{outmoves}) \end{array}$$

At least two previous studies in Adelaide (Hugo, 1971a and Chugg, 1971) have been made involving the presentation of estimated rates of net migration for Local Government Areas (L.G.A.s) in the whole or part of the Adelaide Statistical Division. The rates were calculated by using the above formula with net migration the unknown, that is

$$\text{Net Migration} = \text{Net Change} - \text{Natural Increase.}$$

The actual number of births and deaths is officially recorded at the level of the L.G.A. so that natural increase and estimated net migration may be calculated relatively easily for L.G.A.s. But before discussing the spatial distribution of the rates of net migration for the Adelaide Statistical Division, it would seem useful to compare also the distribution of the component elements. Differences in these could help in understanding the pattern of net migration itself. Accordingly the three maps in Figure 3.1 each show the relative rankings of Local Government Areas on one of the three measures, namely, total change, natural increase and net migration, for the intercensal period 1961-66. The statistics for the Adelaide Statistical Division represented on the maps are listed in Table 3.1 which shows that for the whole area, natural increase contributes about 33 per cent only to the total change in population numbers. The residual figure of 67 per cent emphasizes the relative importance of net migration in the total

TABLE 3.1

POPULATION CHANGES 1961-1966 and 1966-1971 L.G.A.'s Adelaide Statistical Division

	Population (June 30)			Population Change 1961-1966.			1966-1971			Natural Increase 1961-1966			1966-1971			Net Migration 1961-1966			1966-1971		
	1961	1966	1971	Number	%	Rank	Number	%	Rank	Number	%	Rank	Number	%	Rank	Number	%	Rank	Number	%	Rank
1 ADELAIDE	23 051	18 619	16 313	-4 432	-19.23	31	-2 306	-12.38	32	54	0.23	29	-451	-2.42	32	-4 486	-19.46	31	-1 855	-9.96	31
2 BRIGHTON	20 377	22 638	22 583	2 301	11.31	12	- 55	- 0.24	21	1 031	5.07	15	499	2.20	23	1 270	6.24	11	- 554	-2.45	20
3 BURNSIDE	36 266	38 776	39 339	2 510	6.92	14	563	1.42	17	249	0.69	28	-143	-0.37	28	2 261	6.23	12	706	1.82	16
4 CAMPBELLTOWN	20 945	32 083	37 942	11 138	53.17	5	5 859	18.26	8	2 760	13.18	6	3 004	9.36	7	8 378	40.00	5	2 855	8.89	9
5 COLONEL LIGHT GARDENS	3 671	3 404	3 369	- 267	- 7.27	28	- 35	- 1.03	23	120	-3.27	31	- 29	-0.85	31	- 147	- 4.00	23	- 6	-0.18	18
6 EAST TORRENS	3 664	3 822	4 202	158	4.31	16	380	9.94	11	231	6.30	10	254	6.65	9	- 73	- 1.99	20	126	3.30	14
7 ELIZABETH (a)	(a)	32 956	33 389	--(a)--			433	1.31	18	--(a)			2 390	7.25	8	--(a)--			-1 957	-5.94	27
8 ENFIELD (b)	72 427	80 366	79 635 (b)	7 909	10.92	13	- 701	- 0.87	22	4 572	6.31	9	3 452	4.30	12	3 337	4.61	14	-4 153	-5.17	25
9 CAWLER	5 639	5 703	5 495	64	1.13	21	- 208	- 3.65	27	94	1.67	25	26	0.46	25	- 30	- 0.53	17	- 234	-4.10	23
10 GLENELG	14 492	14 763	15 237	271	1.87	20	474	3.21	16	183	1.26	26	- 104	-0.70	30	88	0.61	16	578	3.91	13
11 HENLEY & GRANGE	11 680	14 146	16 128	2 466	21.11	6	1 982	14.01	9	832	7.12	8	692	4.89	11	1 634	13.99	6	1 290	9.12	8
12 HINDMARSH	12 914	11 367	10 306	-1 547	-11.98	30	-1 061	- 9.33	31	634	4.91	20	330	2.90	19	-2 181	-16.89	30	-1 391	-12.24	32
13 KENSINGTON & NORWOOD	13 476	11 943	11 081	-1 533	-11.38	29	- 862	- 7.22	30	551	4.09	21	51	0.43	26	-2 084	-15.46	29	- 913	-7.64	28
14 MARION	58 464	66 984	67 572	8 520	14.57	8	588	0.88	19	4 422	7.56	7	2 701	4.03	14	4 098	7.01	10	-2 113	-3.15	22
15 MEADOWS (c)	(whole)	5 085	(5 668)	-	583	11.46	11	--	--	273	5.37	14	--	--	--	310	6.09	13	--	--	--
	(part)	(2 242)	2 824	5 128	(582)		2 304	81.57	2	--	--	--	443	15.69	5	--	--	--	1 861	65.90	2
16 MITCHAM	43 122	49 485	54 377	6 363	14.76	7	4 892	9.89	12	1 887	4.38	17	1 947	3.93	15	4 476	10.38	7	2 945	5.95	10
17 MUDDLA WIRRA (d)	(whole)	1 562	(1 559)	-	3	- 0.19	22	--	--	217	13.89	5	--	--	--	- 220	-14.08	28	--	--	--
	(part)	(111)	155	186	(44)		31	20.00	6	--	--	--	6	3.87	16	--	--	--	25	16.13	7
18 MUNNO PARA	3 154	14 276	20 179	11 125	352.73	1	5 900	41.32	5	971	30.79	2	2 280	15.97	4	10 154	321.94	1	3 620	25.35	5
19 NOARLUNGA	5 492	14 214	28 464	8 722	158.81	3	14 250	100.25	1	1 077	19.61	3	2 762	19.43	1	7 645	139.20	3	11 488	80.82	1
20 PAYNEHAM	14 930	16 847	17 543	1 917	12.84	10	696	4.13	15	604	4.05	22	296	1.76	24	1 313	8.79	8	400	2.37	15
21 PORT ADELAIDE	38 923	39 846	38 968	923	2.37	19	- 878	- 2.20	25	1 722	4.42	16	1 100	2.76	20	- 799	- 2.05	21	-1 978	-4.96	25
22 PROSPECT	22 184	21 415	20 934	- 769	- 3.47	26	- 481	- 2.25	26	256	1.15	27	- 118	-0.55	29	-1 025	- 4.62	24	- 363	-1.69	19
23 ST. PETERS	11 727	11 339	10 675	- 388	- 3.31	25	- 664	- 5.86	29	393	3.35	24	253	2.23	22	- 781	- 6.66	26	- 917	-8.09	29
24 SALISBURY	35 715	35 766	56 279 (a)	33 007 (a)	92.42	4	20 513	57.35	4	5 585	15.64	4	5 745	16.06	3	27 422	76.78	4	14 768	41.29	4
25 STIRLING	7 075	7 552	8 359	477	6.74	15	807	10.69	10	421	5.95	11	452	5.98	10	56	0.79	15	355	4.70	11
26 TEA TREE GULLY	5 887	21 315	36 708	15 428	262.07	2	15 393	72.22	3	1 974	33.53	1	3 883	18.22	2	13 454	228.54	2	11 510	54.00	3
27 THEBARTON	12 844	12 303	11 831	- 581	- 4.51	27	- 472	- 3.87	28	641	4.98	18	517	4.20	13	-1 222	- 9.48	27	- 989	-8.04	30
28 UNLEY	40 280	39 735	39 928	- 545	- 1.34	23	193	0.49	20	- 101	-0.25	30	- 49	-0.12	27	- 444	- 1.09	18	242	0.61	17
29 WALKERVILLE (e)	4 464	4 593	5 008 (e)	129	2.89	18	415	9.03	13	260	5.82	12	541	11.78	6	- 131	- 2.93	22	- 126	-2.74	21
30 WEST TORRENS	40 681	46 233	50 097	5 552	13.65	9	3 864	8.36	14	1 998	4.91	19	1 784	3.86	17	3 554	8.74	9	2 080	4.50	12
31 WILLUNGA (f)	(whole)	2 556	(2 517)	-	39	- 1.53	24	--	--	102	3.99	23	--	--	--	- 141	- 5.52	25	--	--	--
	(part)	(2 210)	2 190	2 614	(- 20)		424	19.36	7	--	--	--	60	2.74	21	--	--	--	364	16.62	6
32 WOODVILLE	71 039	73 930	72 806	2 891	4.06	17	-1 124	- 1.52	24	3 886	5.47	13	2 504	3.39	18	- 995	- 1.40	19	-3 628	-4.91	24
Not incorporated (g)			18 (d)																		
TOTAL	(part)	771 561	842 693				71 114	9.22					37 079	4.81					34 035	4.41	
	(whole)	663 786	776 136	112 350	16.93					37 659	5.67					74 691	11.25				

Footnotes:

- (a) Prior to 1966 figures for Elizabeth included with Salisbury.
(b) To maintain comparability adjustment has been made in the above figures to allow for transfer in July 1970 of suburb of Vale Park from Enfield to Walkerville.
(c) Prior to the 1966 Census figures only available for the total L.G.A. After that date figures are for only that part within the Adelaide Statistical Division.
(d)
(e)
(g) Torrens and Garden Island included in Adelaide Statistical Division subsequent to 1966 Census.

pattern. Furthermore it suggests that, because net migration is only the end product of a much greater amount of activity, study of the process itself seems likely to be of some importance in understanding the quality as well as the quantity of population movement.

3.2 ANALYSIS BY LOCAL GOVERNMENT AREAS

3.2.1 1961 to 1966:

A comparison of all three maps shown together in Figure 3.1 reveals a general similarity in spatial distribution. This may be summarized in terms reminiscent of the concentric zonation model of urban development propounded by Burgess (1925). Stated simply, the present case is that there is a general increase in scores with increasing distance from the Central Business District (C.B.D.). The highest scores on all measures occur in two diametrically opposed outer areas -- firstly, the north and north-east and secondly, the south-east. A less obvious peak appears on the coast, west of the C.B.D. The lowest scores occur in the continuous inner circle of L.G.A.s including the C.B.D. By implication, the middle suburbs exhibit middle-of-the range scores.

Predictably it is the distribution of net migration (Fig. 3.1/3) which more closely resembles that of total change (Fig. 3.1/1). Spearman's Rank Correlation Coefficient is $R = 0.964$ as compared with $R = 0.728$ between natural increase and total change. The degree of similarity between distributions of net migration and natural

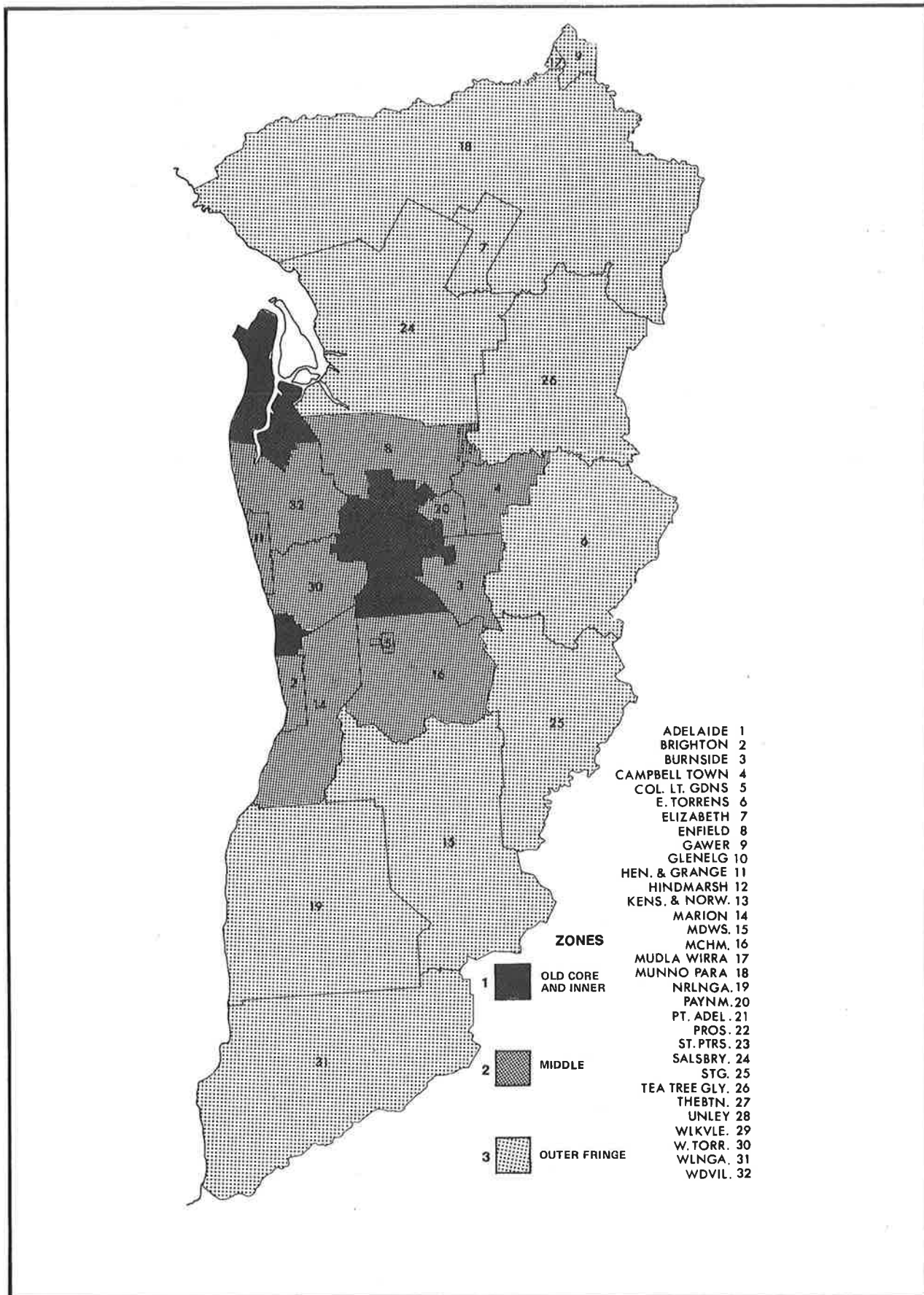

FIG. 3.2: Concentric zonation of local government areas in the Adelaide Statistical Division (for discussion purposes). Source: Author.

increase (Fig. 3.1/2) is lowest with $R = 0.576$. All relationships were statistically significant at better than 0.01 (df 29). However such generalizations should not be allowed to obscure or exclude consideration of some of the differences to be found on a closer examination. Hopefully they may shed some light in the search for meaning in the spatial variations.

The accompanying Figure 3.2 shows the study area divided into three arbitrary concentric zones of L.G.A.s to provide a frame of reference in further discussion, particularly of population change.

3.2.1.1 Total population change (see Fig. 3.1/1)

Rates of change with increased distance from the C.B.D. vary in different directions. Both north and south there is a fairly rapid increase with distance to high rates of growth. To the north-west and south-east the increase is much less steep, the peak values failing to reach even the city-wide average.

Low rates of growth (or even slight decreases) are recorded in some areas beyond the near inner areas where the Burgess model would lead one to expect them. There are four such areas all widely scattered. Two are old urban nuclei, Glenelg and Port Adelaide, after the pattern of the Harris and Ullman (1945) multiple nuclei model of urban structure. The other two are rural areas on the rural-urban fringe, Mudla Wirra-Gawler in the north and Willunga in the south.

The middle suburb of Colonel Light Gardens calls for comment

because it shows in isolation a strong decline without being a truly old core nucleus of the kind already described. It is a small area of uniformly-aged housing set up as part of a special project in post World War I times. It is to be expected that a well-aged population would display such a decrease. Perhaps some other middle suburbs also share the same trend but remain "invisible" because they are offset by nearby suburbs of different characteristics within the L.G.A. Throughout the following analyses Colonel Light Gardens appears somewhat anachronistically as an "old core" area and is treated as such in the discussions although not zoned as one.

3.2.1.2 Natural increase (see Fig. 3.1/2)

Compared with the distribution of total change, the most obvious differences appear in the middle suburbs and nearer fringe where most L.G.A.s are classified in a different quintile. For example, East Torrens and Stirling to the east and Enfield and Walkerville to the north score above average rates of natural increase in contrast to well below average total change. The following areas all have rates of natural increase ranked lower than for their total change: Brighton, Burnside, Glenelg, Meadows, Mitcham, Port Adelaide, West Torrens and Unley. Most inner areas are up just a little on rates of natural increase but Thebarton is up by two classes. An interesting case is Gawler, an old urban entity in the rural fringe which displays a rate of natural increase comparable with the old core and inner areas.

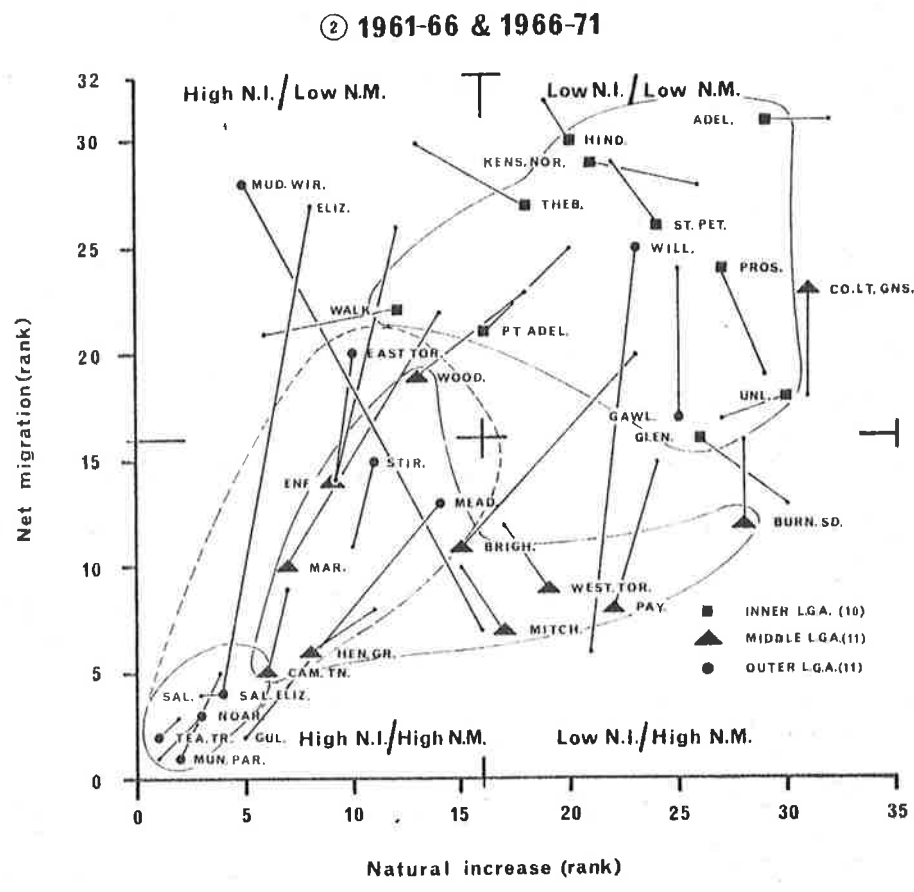
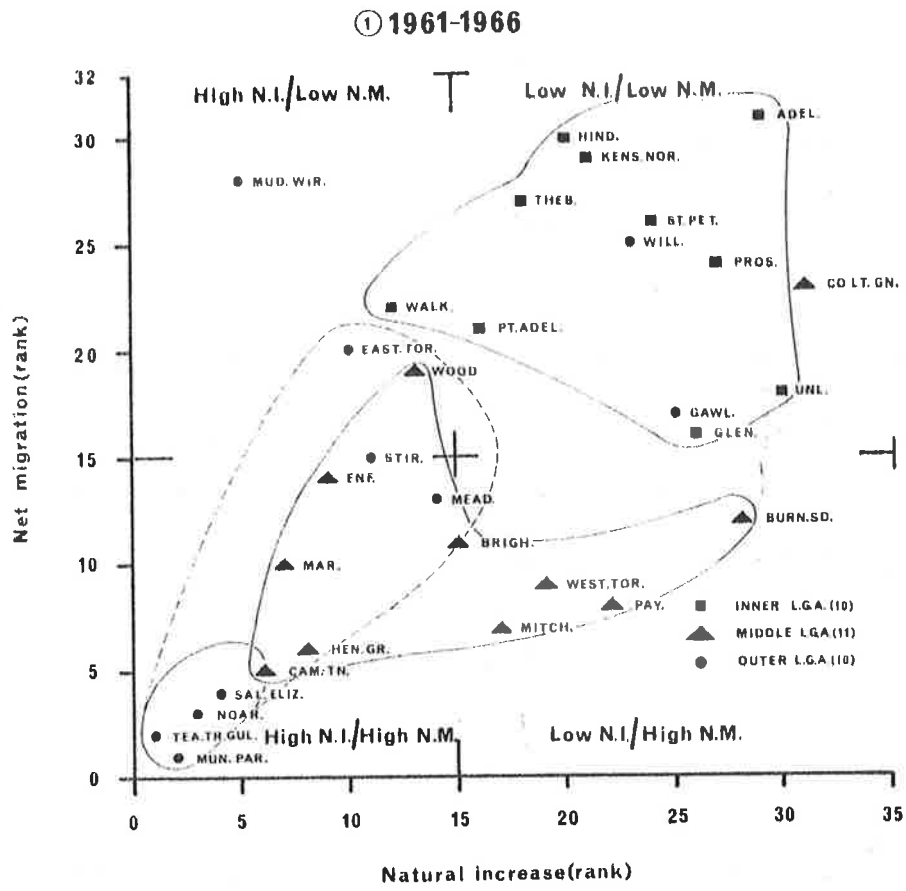

FIG. 3. 3. Comparison of L.G.A. rankings on rates of natural increase and net migration (1) 1961-66 (2) 1961-66 and 1966-71.

3.2.1.3 Net Migration (see Fig. 3.1/3)

As indicated by the rank correlation indices quoted earlier, the distributions of net migration and total change in the population are very similar. Net migration is relatively a little more important as a component of change in Burnside, Gawler, Glenelg, Unley, Prospect and Colonel Light Gardens - a mixture from all zones. Areas where net migration is relatively lower in importance than natural increase are East Torrens, Mudla Wirra and Walkerville.

The relationship between rank scores on net migration and natural increase and their spatial distribution is shown graphically in the accompanying Figure 3.3/1. It is clear that a general association exists between the location of an L.G.A. within the total city and its rank on the two components of population change. The association may be summarized as follows:

(a) old core and inner areas (low/low)

low natural increases

low net migration

(b) middle suburbs: (middle/middle)

medium natural increase over a wide range of rankings but
without extremes

middle to high range of net migration

(c) outer and fringe areas:

(i) urban growth areas (high/high)

high ranking on both natural increase and net
migration

(ii) urban rural fringe (middle/middle)

natural increase close to the mean, net migration

middle range below the mean

(iii) rural urban fringe (low/low)

variable, but generally low on both elements,

except one case of high natural increase.

The above is further summarized in the accompanying Table 3.2

TABLE 3.2

Classification of Local Government Areas according to rankings on natural increase and net migration 1961-1966.

Ranking Class L.G.A. Zone Categories	Low Natural Increase	High Natural Increase	High Natural Increase	Low Natural Increase	Totals
	Low Net Migration	Low Net Migration	High Net Migration	High Net Migration	
Inner and Core	9	1	0	0	10
Middle	1	1	5	4	11
Outer	2	3	5	0	10
TOTALS	12	5	10	4	31

Underlying the foregoing discussion has been the expectation that within the total urban area regional shifts occur over time. It is appropriate therefore, to test this in the circumstances at present under consideration by repeating the analysis for the succeeding intercensal, 1966 to 1971.

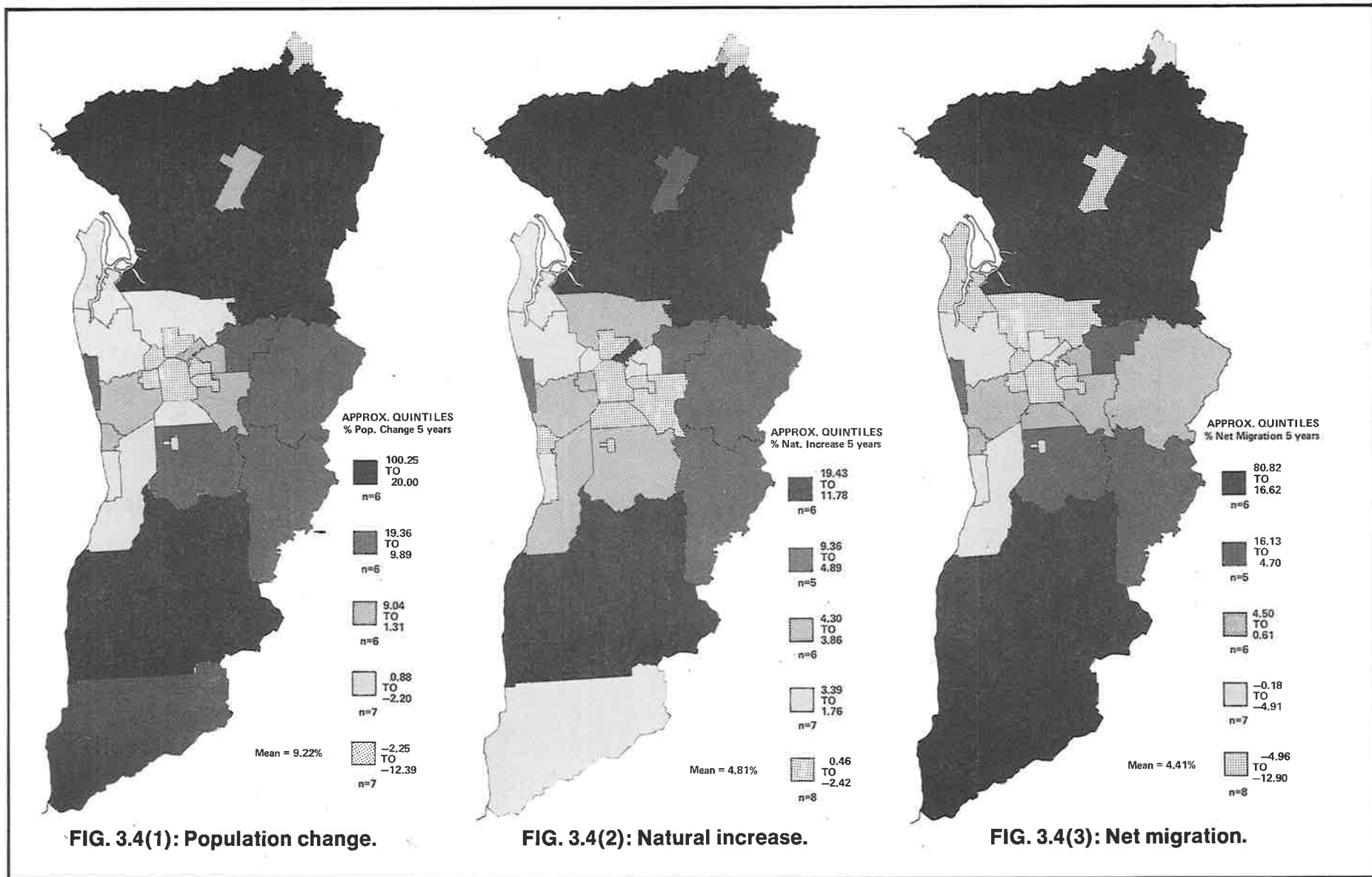

FIG. 3.4: Percentage population changes in Local Government Areas 1966-71.

Source: Australian Bureau of Statistics.

3.2.2 Comparison of intercensal population changes, 1961-1966 and 1966-1971

The comparable data for the elements of population change are displayed in the three maps of Figure 3.4. The shift in rank for each L.G.A., in both natural increase and net migration, is shown graphically in Figure 3.3/2.

3.2.2.1 General comparisons

Rates of change on all three measures declined markedly in the second five year period. Population growth declined from 16.9 per cent to 9.3 per cent, natural increase from 5.7 per cent to 4.8 per cent and net migration from 11.3 per cent to 4.5 per cent. Correlation analyses for the whole study area reveal that ranking for natural increase is comparatively unchanged ($R = 0.900$). Although patterns of net migration were still similar ($R = 0.604$) noticeable change had occurred. The rank correlation for overall population change was $R = 0.723$. All values were significant at better than 0.01 (df 30).

3.2.2.2 Population change

In most areas rates of population change decreased comparatively as already noted. This was especially noticeable in the middle suburbs and in certain former high growth areas: Elizabeth, Campbelltown and Henley Beach. These latter areas were clearly approaching the stage of being fully built-up.

Increases in growth rates occurred in two contrasting zones, namely the fringe and in some old-core and inner areas. Mudla Wirra,

Meadows, Willunga, East Torrens and Stirling are in the former group and Glenelg, Unley and Colonel Light Gardens in the latter.

3.2.2.3 Natural increase

Examples of increase in ranking on natural increase are few but spectacular and occur in all zones within the study area. Meadows in the rural fringe, Walkerville in the near middle suburbs and Thebarton in the inner suburbs all improved rank by at least five places. Large decreases were equally as widely scattered, for example, Mudla Wirra, Brighton, Marion, Woodville and Kensington-Norwood all dropped five or more places.

3.2.2.4 Net migration

As noted under "General Comparisons" (section 3.2.2.1) it is the net distribution of migration which shows most alteration over the two periods. Alterations both positive and negative occur in each zone. Outer fringe areas in the main show an increase in net migration with the exception of Elizabeth, Munno Para and Campbelltown. The middle suburbs generally experienced a relative decline with the interesting exception of Walkerville. Although some old core and inner areas declined (especially Gawler and Port Adelaide) others showed evidence of a relative revitalization - Colonel Light Gardens, Prospect and Glenelg were up three places or more and Kensington-Norwood and Unley up one place only.

3.2.2.5 Summary

Three general trends in population changes are apparent in the shift over the two intercensal periods which are summarized in

the graph Figure 3.3/2: firstly, the middle suburbs are rapidly becoming low growth areas like those of the adjoining old core and inner areas; secondly, the trend in the rural fringe is toward rapid growth and thirdly, some old core areas are undergoing a revitalization with relative increases in population.

At the beginning of this section reference was made to the general visual resemblance of the map of population change to the concentric zonation of the Burgess (1925) model of urban development. Now that the two elements of population change over a decade in Adelaide have been reviewed, further resemblances have appeared. In the main these derive from the fact that most urban growth has continued to occur on the outer edges of already established areas. Furthermore, the new housing areas tend to be inhabited by younger married couples who move there from the older established areas. It is this section of the population which generates the higher birth rates. The population in the older areas appears to age and decrease the more rapidly through the withdrawal of its younger members. From the aggregate of these behaviours there appears a kind of continuing wave or frontier of high urban growth advancing outwards from the city-centre leaving behind it a trough of decline. Well in front of it, in the near rural areas, is another trough of decline.

The notion of a wave of urbanization based upon the Burgess pattern is far from new, having been discussed by such authors as Blumenfeld (1949 and 1954), Alonso (1964), Wolf (1969) and Morrill (1970). However, it is sufficient here to have pointed out the

facts which suggest the operation of such a pattern in this specific case. "A micro-level theory of urban growth suggests that the demand for space by new activities may be separated into a series of waves" (Morrill, 1970, p.174).

3.3 COMPARISON OF POPULATION CHANGES BY CENSUS C.D.s AND L.G.A.s 1961-1966

During the early stages of this study in gathering and processing of census data, considerable work was done at the level of individual census collector's districts (C.Ds) for the intercensal period 1961-1966. Although analysis was not continued at this scale, some interesting features emerged. Some are mentioned here as a passing acknowledgment and illustration of the extent to which spatial generalization disguises internal variation.

Comparison between L.G.A.s is complicated by the enormous variation in sizes of both population and territory, a fact noted also by Stimson (1971, p.2) and Stimson and Cleland (1975, p.27). In 1961 the largest L.G.A. had approximately 24 times the population of the smallest while variation between extreme census C.Ds was generally about twelve to one. It is to be expected therefore that with fewer extreme data units and a finer spatial network, useful patterns not evident at a coarser scale should have emerged. Rates of population change were calculated and then grouped into deciles for mapping in terms of 1961 C.Ds. The most outstanding features to appear are described briefly below for only two categories of L.G.A.s - areas with high growth rates and areas

with low growth rates.

3.3.1 Within L.G.A.s of highest growth rate

(a) Elizabeth-Salisbury L.G.A.s, despite the high growth ranking, have areas of decrease in the earliest settled "core" parts near the Little Para River surrounded by areas of moderate growth. The most spectacular increases, which clearly dominate the general trend, occur further away towards the L.G.A. peripheries.

(b) Noarlunga has its highest growth in the northern and north-eastern half, nearer the C.B.D. It had a core of lower growth around the long established Port Noarlunga with further decreases inland and toward the south.

(c) Tea Tree Gully has two small pockets where growth rates, which though still high, are less than in the remainder of the L.G.A. One includes the original village at the city-ward end and the other is a hilly rural area along the eastern border.

3.3.2 Within L.G.A.s of less than average growth

Many L.G.A.s of only moderate growth contain pockets in the top growth decile. The following are examples.

(a) Woodville has high growth in the south-west, compensating for large areas of moderate decline along the Port Road.

(b) West Torrens has high increases in its western half, contrasting with heavy decline in the east toward the C.B.D.

(c) Port Adelaide is generally an area of heavy decline but at

Largs and Taperoo are C.Ds with strong growth, one in the top decile.

(d) Enfield has three separate high growth centres, one each in the north-west, north-east, and south-east.

(e) Burnside displays a nice gradation with decline near the C.B.D. and steady increases in growth rate with distance to the east, reaching the top decile along the foothills with strong but less intense growth beyond.

(f) Marion and Mitcham also display this kind of general gradation away from the C.B.D. and into the foothills.

(g) Walkerville, though a small inner L.G.A. of low growth, includes some C.Ds with decreases and others with increases. In this regard at least, it is unique amongst the inner L.G.A.s, a point to be noted later with regard to rates of population turnover.

(h) Stirling, a unique L.G.A. in the Adelaide Hills, has an island of peak growth (decile 10) with fall off in rates of growth in all directions to areas of decline (decile 1) in the north-east. In the north-west, toward the city centre, after a low trough (decile 6) there is a steady increase until peak growth (decile 10) reappears in the outer edges of the adjoining L.G.A. Mitcham.

(i) Glenelg has an inner core of decrease but an outer ring of moderate increase.

3.4 SOME FURTHER QUESTIONS

The foregoing analyses of differences in growth rates and net migration rates suggest that a very considerable amount of residence changing is going on within the Adelaide Statistical Division. Furthermore, it is clear that regardless of whether movement of residents is mainly in or out of L.G.A.s it is having a greater relative influence on the population composition of the areas concerned than mere aging and natural increase alone.

So far, only net migration, the effect, not the actual movement, has been described. This, therefore, raises speculation on the obvious question of what amounts of real movement areas have experienced. Similarly it can be asked which areas are linked together through flows? Are moves between them chiefly inward or outward? What are the distances and directions of such moves especially with regard to the total form of the city?

It is obvious that to answer these questions it is necessary to obtain actual counts of movements between spatial units or cells. However, as pointed out already, the census on which analysis to this point has been based, does not provide anything suitable to answer the above questions even though, for the first time in an Australian census, information was gathered in 1971 about the address of respondents at the previous census. Although this does not answer the questions just posed, the data will be used later in this study (section 4.2).

3.4.1 The need for another source of data

One of the major difficulties facing those who study internal migration is that of obtaining suitable data. Moore (1969b, p.114) saw this as the main problem in pursuing empirical research at the aggregate level and claimed that it "constitutes a major research task which could form the basis for much subsequent work". In addition Moore (1966b, p.108 and similarly 1970, p.15) believes that "the approach adopted by the individual student depends to a great extent on the data available". It is claimed by Simmons (1968, pp 649-50) that the nature of the data available in the past has tended to concentrate research on static rather than dynamic patterns. However, it is apparent that as researchers tackle the problems outlined by Simmons, they will be obliged inevitably to discover, modify and adapt available data sources to serve ends for which they were not intended.

Many publications on population movement make no more than passing reference to the source of data, thereby often giving the impression that suitable data are more easily obtained and more reliable than is the case. The purpose of this section is to discuss and evaluate electoral rolls as a source of data on internal migration (Morrill, 1965a, p.33; Wolpert, 1965, p.160). In particular the South Australian composite rolls will be discussed with respect to their characteristics, especially since the change to computer maintenance, and their deficiencies and biases as a source of information on internal migration within the total population, and especially in the Adelaide Statistical Division.

Several European countries maintain continuous population registers like those in Sweden which were the basis for the well known studies by Hägerstrand (1957) and Olsson (1965). Where registers do not exist less complete data must be used, such as commercial directories (Adams, 1969; Brown and Holmes, 1971), electoral registers (Moore, 1966b and 1972; and Hugo, 1971a) and public utility account listings (Clark, 1970; Donaldson and Johnston 1973; Whitelaw and Gregson, 1972; Whitelaw and Robinson, 1972).

Any substitute for a population register in the study of migration is certain to have various inherent deficiencies or biases. The latter result from the characteristics of the particular system which is made to yield data for which it was not designed. The user of biased data sources is faced with the problem of selecting from the various alternatives the source which best serves the purpose, discovering the nature and magnitude of the deficiencies and biases of the particular source selected (see Moore, 1972, p.47), and finally making adequate allowance for the shortcomings identified.

Data required for studies of human migration may be divided conveniently into three categories where characteristics are sought for population (movers or stayers), movements, and the environment of donor and receptor areas. Moore (1972, pp 47-8) and Hugo (1971a, Chap.3) have discussed the relative merits of various sources in meeting the need for data. Hugo (1971a, p.73) has concluded that among the admittedly biased sources available in Australia none is more comprehensive in scope, and amenable to analysis than

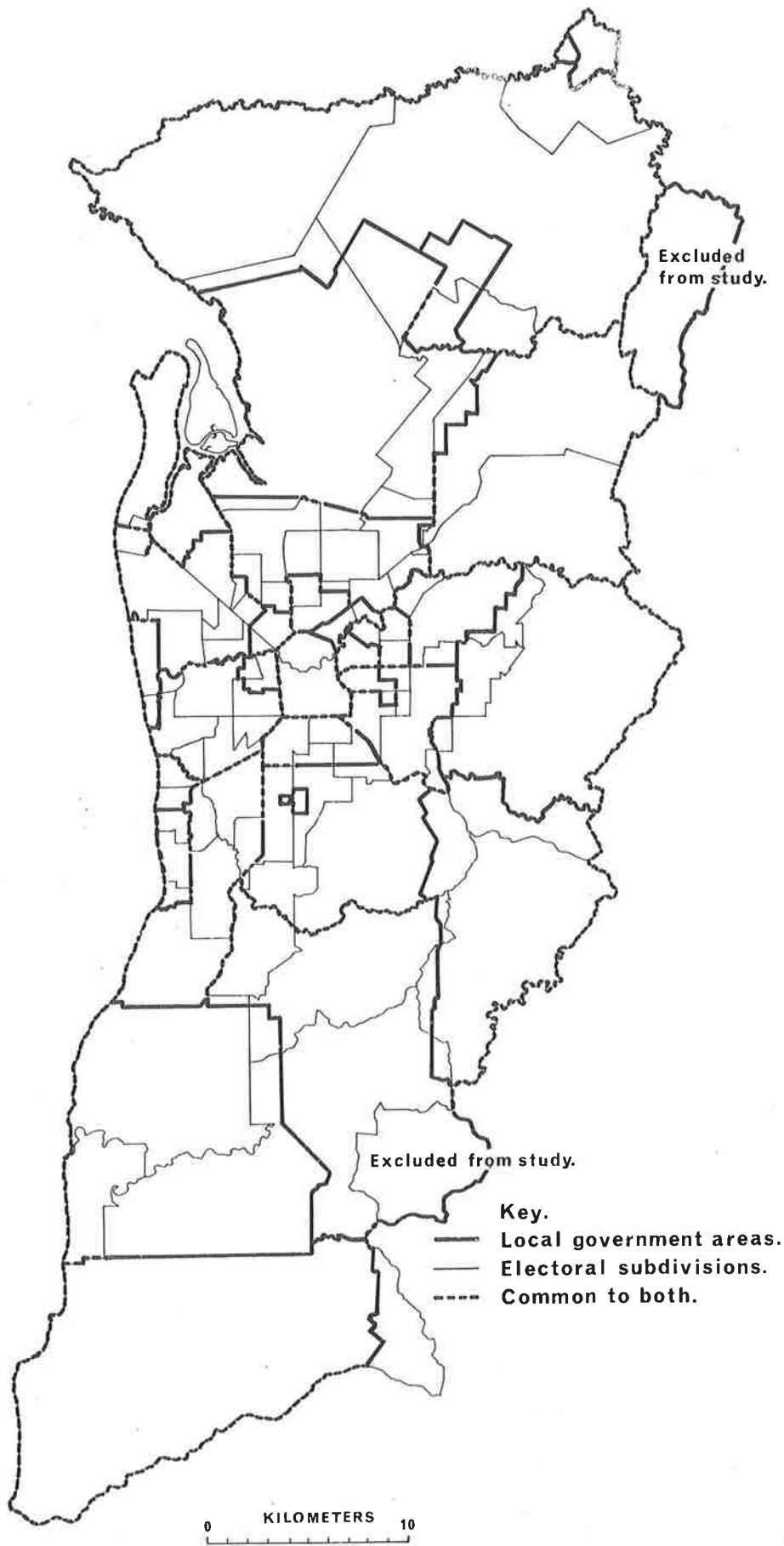

FIG. 3.5. Comparison of boundaries of local government areas and electoral subdivisions, 1971.

Sources: (1) S.A. Year Book, 1972.
 (2) Report of Electoral Commission, 1969.

electoral registers.

The decision was taken therefore, to use electoral rolls as the major data source for this study of intra-urban migration in Adelaide. The decision, while hopefully gaining answers to some questions, introduces new problems, the chief of which are not the practical ones of data collection and handling, important as those problems may be.

The main problem here is one of logic and concerns the difficulty of achieving a satisfactory comparison or statistical link between the different spatial units involved in the change from L.G.A.s (n = 32) to electoral subdivisions (n = 50). In Figure 3.5 the two sets of boundaries are superimposed on a single map for visual comparison. The enforced change from one spatial unit to another could be undertaken with some confidence of preserving portability of information already acquired if strong similarity could be demonstrated between the two different spatial systems. This might be achieved if mapping the same commodity in the two systems yielded patterns of acceptable likeness.

An obvious solution to the change-over problem is to transform data areas to a common basis. One of the two systems could be transformed into the other or both changed into a third system.

The following are cited as specific local examples:

(a) To transform electoral data to conform with L.G.A. boundaries would mean a loss of much of the flow linkage information available for electoral units and thus reduce or negate the value of choosing

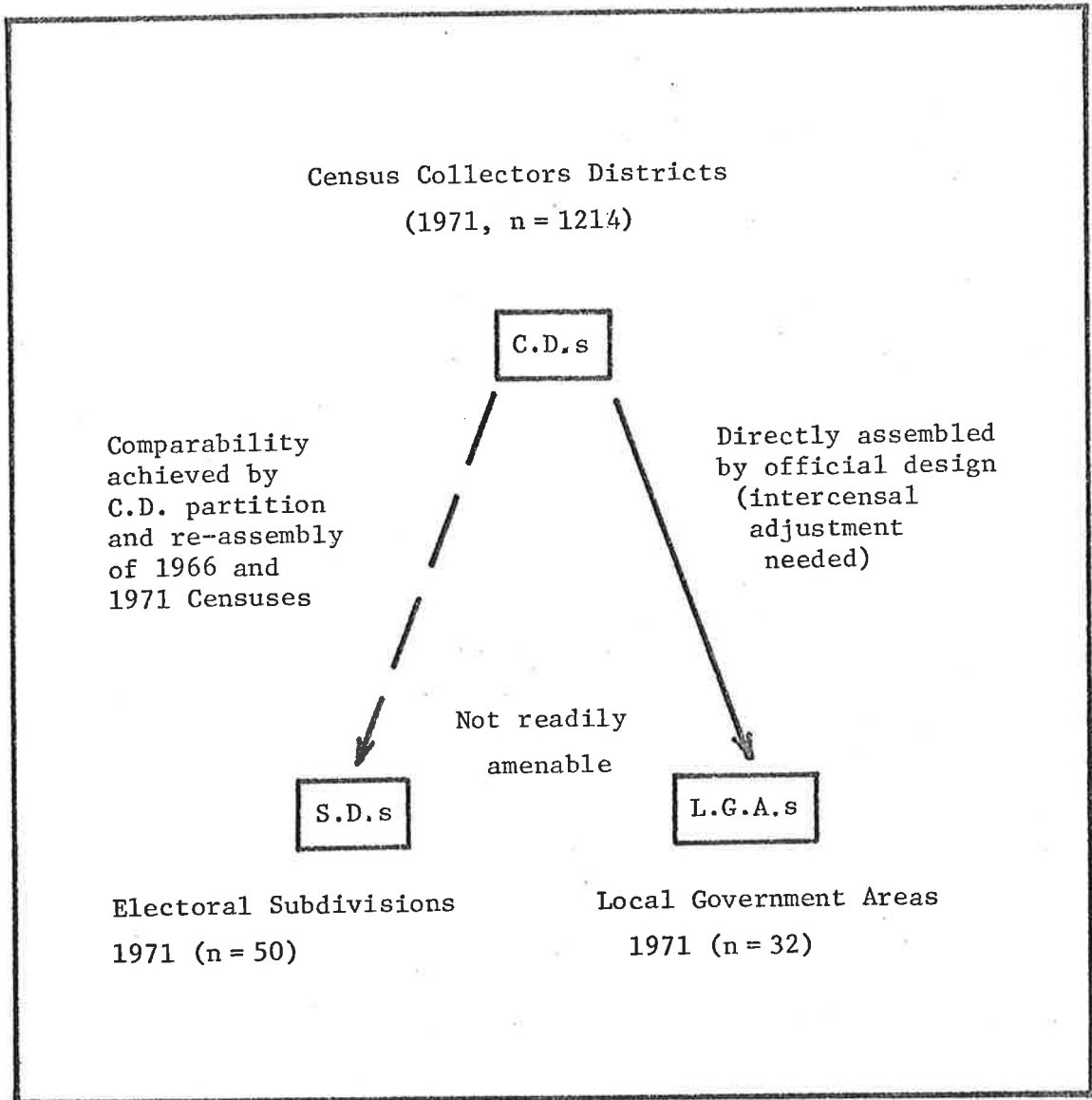

Figure 3.6: Relationships between spatial units used in this study in analysis of population movement, Adelaide Statistical Division.

to use this source.

(b) To transform L.G.A. data to electoral boundaries is clearly a huge chore as the map indicates. The technique usually employed for achieving this involves the transfer of sections of population according to the fraction of a parent area contained within the new. A large amount of approximating would be necessary in this case to transform 32 areas into 50 when perhaps only half of the boundaries coincide. It is questionable whether the necessary approximation would allow any meaningful measure of similarity to emerge.

(c) In section 3.3 it was implied that census C.Ds are devised to nest completely within L.G.A.s. A transformation of the kind desired could be achieved therefore by using census C.Ds as building blocks to assemble areas comparable or even perhaps identical with the electoral subdivisions. This is the approach used in the present study.

Figure 3.6 shows diagrammatically the logical links which exist between the three spatial systems under discussion and the difficulty of achieving comparability.

3.5 COMPARISON OF DATA FROM L.G.A.s, C.Ds AND ELECTORAL S.D.s

Rates of net change in the population totals as measured by the respective data collection systems were selected as the test item for common spatial representation in terms of the fifty electoral subdivisions. The procedures adopted were as follows.

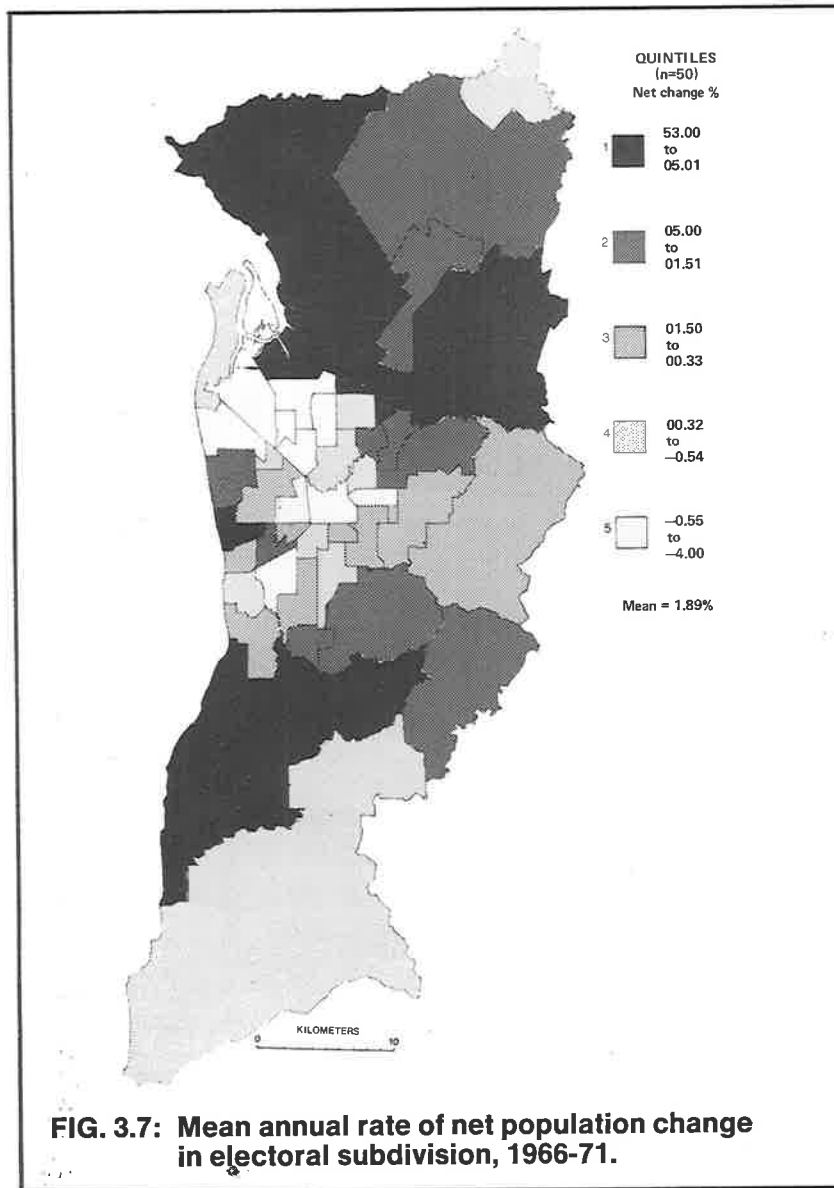

Source: Author's reprocessing of C.D. Census data (1966 and 1971) from C.B.C.S., Adelaide.

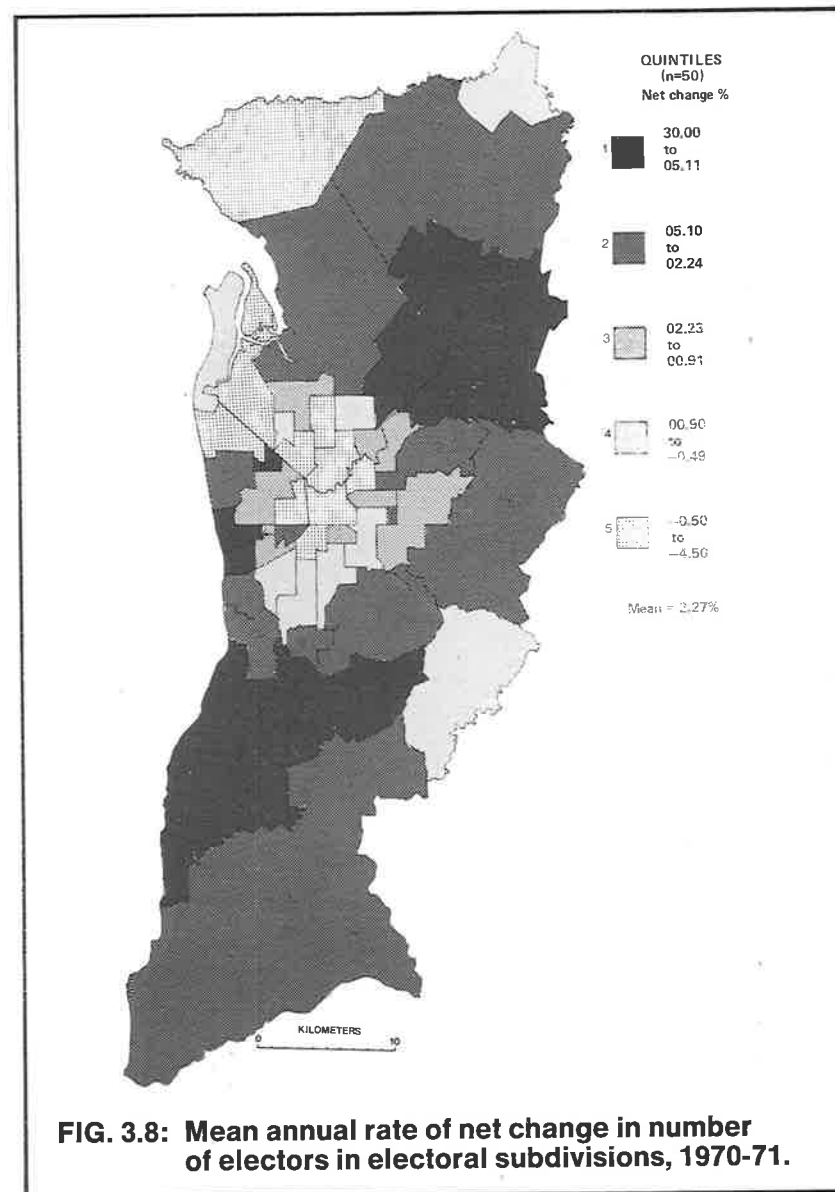

Source: Author's reprocessing of data from State Electoral Dept., Adelaide, 1970-71.

Intercensal changes for collector's districts between 1966 and 1971 were reallocated by grouping, or cutting fractionally where boundary overlay made this necessary, to compile data for each of fifty electoral subdivisions. The intercensal change for electoral subdivisions was mapped as per cent per annum and is shown in Figure 3.7. The comparable data (on the net change in total electors for each subdivision) was gathered from electoral rolls. For reasons explained elsewhere (section 2.3) this was only available for a fifteen month period in 1970-71. Nevertheless this also was mapped as a rate of change in per cent per annum and is shown in Figure 3.8. The statistics represented in the maps are set out in Table 3.3.

To test the null hypothesis that the two distributions are unrelated, the absolute figures of annual change were compared statistically using Pearson's Correlation Coefficient (r). The result ($r = 0.940$, significant at better than 0.005 for 48 degrees of freedom) provides evidence enough that the two data sets are so strongly related that the enforced change-over of spatial units may be undertaken with confidence.

Inspection of the ranking columns in Table 3.2 reveals interesting and important evidence of spatial variability in the degree of similarity of subdivisions on the two scales. Some account needs to be taken of these differences because all subsequent discussion of residential movement is based upon electoral roll data with reference to electoral subdivisions. Spearman's rank correlation (R) was 0.810 and significant at better than 0.05 (df 48) despite the wide

TABLE 3.3

COMPARISON OF NET CHANGES IN POPULATION OF ELECTORAL SUB-DIVISIONS
MEASURED BY CENSUS DATA (1966-1971) and ELECTORAL ROLLS (1970-1971).

CODE NO.	SUB-DIVISION	Intercensal 1966-1971 (a)					Electoral 1970-1971 (b)					
		Population 1966 Census	Population 1971 Census	Total Change (5 years)	Mean Annual Change	% Mean Annual Change	Rank	Electors at 12-3-70	Total Change (15 months)	Mean Annual Change	% Mean Annual Change	Rank
71 = ADELAIDE												
711	ADELAIDE	10 966	8 869	-2 097	-419.4	-3.82	50	3 814	-213	-170	-4.46	50
712	FLOREY WEST	17 503	17 236	- 267	- 53.4	-0.31	38	9 767	- 32	- 26	-0.26	38
713	GILLES WEST	11 486	12 367	881	176.2	1.53	20	6 653	185	148	2.22	21
714	ROSS SMITH	20 487	19 033	-1 454	-290.8	-1.42	48	11 843	-173	-138	-1.16	46
715	ST. PETERS	15 260	14 956	- 304	- 60.8	-0.40	40	8 076	-203	-162	-2.01	48
716	TORRENS	26 616	26 264	- 352	- 70.4	-0.26	37	15 884	-183	-146	-0.92	43
72 = ANGAS (Part)												
722	FISHER EAST Part	6 159	6 758	599	119.8	1.95	19	4 125	- 8	- 6	-0.15	36
724	HEYSEN NORTH	3 627	3 825	198	39.6	1.09	24	2 433	104	83	3.41	15
73 = BARKER (Part)												
730	ALEXANDRA Part	4 250	4 315	65	13.0	0.31	31	2 326	110	88	3.78	14
731	FISHER SOUTH	775	1 226	451	90.2	11.64	6	597	91	73	12.19	6
732	FLAGSTAFF HILL	1 021	2 790	1 769	353.8	34.65	2	975	351	281	28.80	1
736	MOANA	538	1 951	1 413	282.6	52.53	1	844	160	128	15.16	4
74 = BONYTHON												
741	ELIZABETH	28 108	33 994	5 886	1 177.2	4.19	13	14 752	707	566	3.83	13
742	FLOREY EAST	10 286	18 373	8 087	1 617.4	15.72	4	6 774	1 437	1 150	16.97	3
743	MODBURY NORTH	4 682	11 544	6 862	1 372.4	29.31	3	4 226	1 230	984	23.28	2
744	PLAYFORD	28 785	35 767	6 982	1 396.4	4.85	12	15 132	1 801	1 441	9.52	8
745	SALISBURY	22 386	29 591	7 205	1 441.0	6.44	9	13 841	520	416	3.00	17
75 = BOOTHBY												
751	BRAGG	24 288	24 706	418	83.6	0.34	30	15 337	32	26	0.16	33
752	FISHER NORTH	12 374	15 733	3 359	671.8	5.43	11	8 572	546	437	5.09	11
753	LEABROOK	1 812	1 948	136	27.2	1.50	21	1 400	42	34	2.40	18
754	MITCHAM	23 415	23 697	282	56.4	0.24	32	15 840	0	0	0.00	34
755	NORWOOD	15 423	14 464	- 959	-191.8	-1.24	45	8 095	122	98	1.20	27
756	UNLEY	10 875	11 110	235	47.0	0.43	29	6 328	135	108	1.70	24
77 = HAWKER												
771	ASCOT PARK	26 084	25 329	- 755	-151.0	-0.58	41	15 747	- 77	- 62	-0.39	39
772	FISHER WEST	4 298	4 969	671	134.2	3.12	15	2 258	141	113	4.99	12
773	GOODWOOD	15 094	14 856	- 238	- 47.6	-0.32	39	9 490	-322	-258	-2.71	49
774	HANSON EAST	11 101	12 183	1 082	216.4	1.95	18	7 382	195	195	2.11	22
775	MARLESTON	7 207	7 473	266	53.2	0.74	27	4 431	- 6	- 5	-0.10	35
776	MITCHELL	26 256	27 484	1 228	245.6	0.94	25	15 838	106	85	0.53	32
78 = HINDMARSH												
781	BEVERLEY	6 157	6 181	24	4.8	0.08	33	3 358	296	237	7.05	9
782	HANSON NORTH	4 355	5 860	1 505	301.0	6.91	24	2 251	173	138	6.14	10
783	HENLEY BEACH	27 650	30 384	2 734	546.8	1.98	17	16 380	673	538	3.28	16
784	PEAKE	26 546	27 737	1 191	238.2	0.90	26	15 483	209	167	1.07	28
785	SPENCE SOUTH	18 324	17 190	-1 134	-226.8	-1.24	44	9 533	-194	-155	-1.62	47
786	THEBARTON	16 393	15 872	- 521	-104.2	-0.64	42	8 556	- 97	- 78	-0.90	42
79 = KINGSTON												
791	BRIGHTON	28 837	29 877	1 040	208.0	0.72	28	16 267	348	278	1.71	24
792	GLENELG	26 252	26 218	- 34	- 6.8	-0.03	35	16 375	195	156	0.95	29
793	HANSON SOUTH	10 930	11 746	816	163.2	1.49	22	7 141	209	167	2.34	19
794	MAWSON	18 352	32 205	13 853	2 770.6	15.10	5	14 297	2 316	1 853	12.95	5
80 = PORT ADELAIDE												
801	ALBERT PARK	23 157	21 702	-1 455	-291.0	-1.26	46	12 567	-147	-118	-0.93	44
802	ANGLE PARK	8 015	7 649	- 366	- 73.2	-0.91	43	3 547	86	69	1.93	23
803	PRICE	29 986	27 883	-2 103	-420.6	-1.40	47	16 398	-217	-174	-1.05	45
804	SEMAPHORE	28 919	28 670	- 249	- 49.8	-0.17	36	16 693	- 38	- 30	-0.18	37
805	SPENCE NORTH	11 591	10 523	-1 068	-213.6	-1.84	49	6 416	- 38	- 30	-0.47	40
81 = STURT												
811	COLES	29 349	33 946	4 597	919.4	3.13	14	16 838	473	378	2.24	20
812	DAVENPORT	23 225	24 731	1 506	301.2	1.30	23	14 748	176	141	0.95	29
813	GILLES EAST	15 907	17 779	1 872	374.4	2.35	16	8 949	165	132	1.47	26
814	HIGHBURY	17 551	26 098	8 547	1 709.4	9.74	7	11 780	1 515	1 212	10.28	7
82 = WAKEFIELD (Part)												
823	GOYDER Part	1 114	1 439	325	65.0	5.83	10	590	- 4	- 3	-0.54	41
824	LIGHT NORTH Part	7 258	7 259	1	0.2	0.00	34	4 477	48	38	0.85	31
TOTAL		771 030	843 760	72 730	14 546	1.89		455 424	12 945	10 397	2.27	

SOURCE: (a) Australian Bureau of Statistics, Censuses June 30, 1966 and June 30, 1971
(b) Information supplied by State Electoral Department for May 12, 1970 and June 11, 1971.

Relative ranking of growth in Electoral subdivisions measured by the Census and Electoral rolls

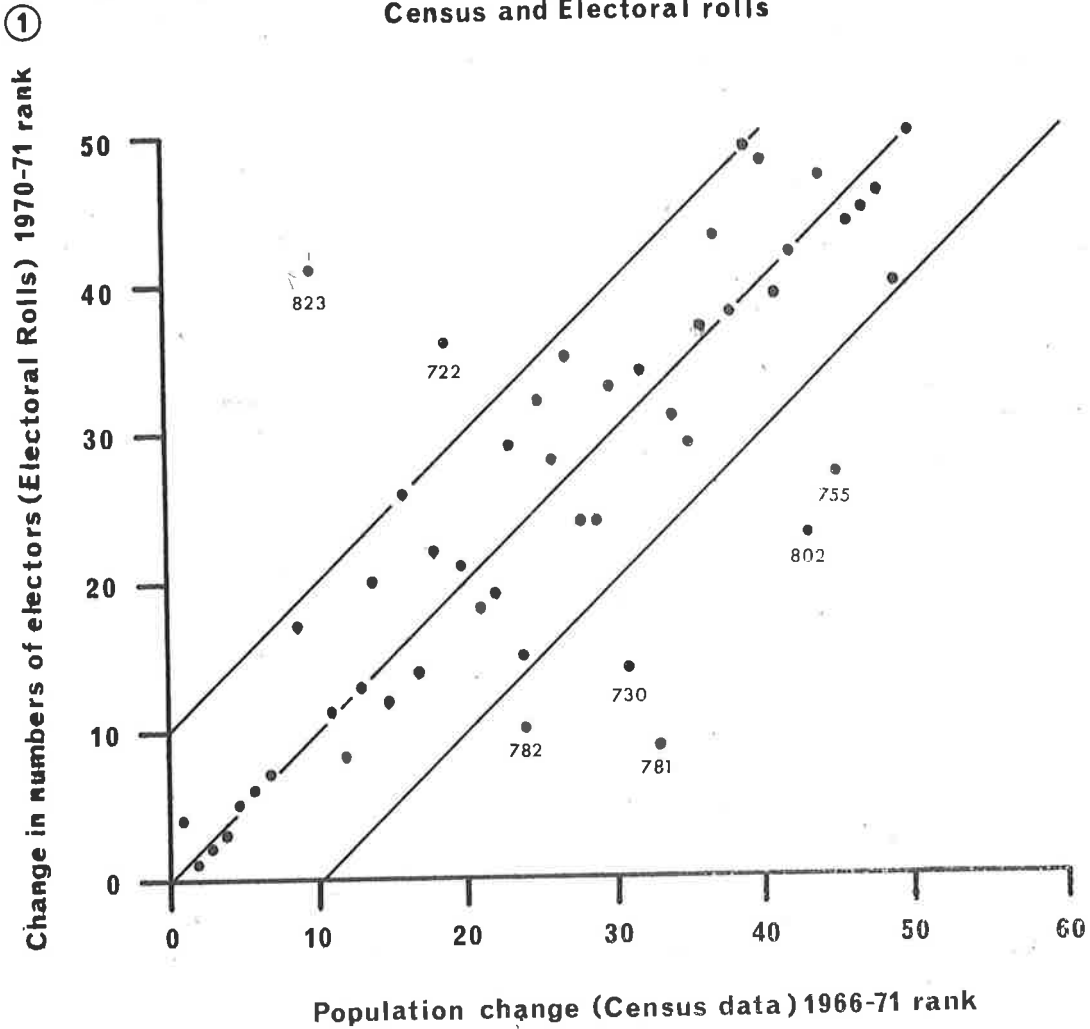

Frequency of ranking deviations of Electoral change compared with Census change

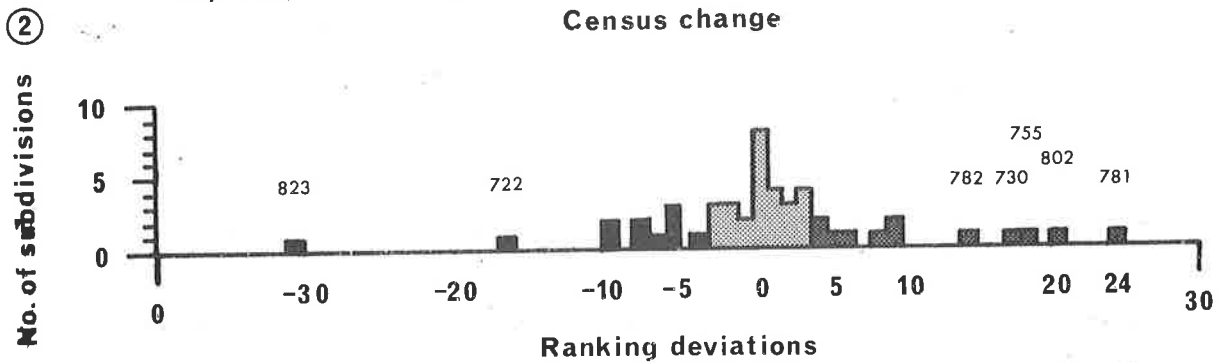

FIG. 3.9. Relative population change measured by census and electoral records.

variation in some cases,

The accompanying graphs (Figure 3.9) present rank deviations in two ways: firstly, for each subdivision on the combined scales with the largest deviations individually identified and secondly, a frequency distribution showing both positive and negative deviations with the whole range divided into three classes. These are shown also on the accompanying map (Figure 3.10).

The discussion which follows centres around explanation for each of the two groups of extreme deviations. The arbitrary decision has been made that only subdivisions with deviations of four or more rank positions warrant consideration and those with seventeen and over need close scrutiny. Considerable reference will be made to the following maps and diagrams which are to be found in other sections of this study.

Fig. A.5 Index X4 Child-woman ratio

Fig. A.6 Index X5 Percentage dependent children

Fig. A.12 Index X11 Percentage single females

Fig. A.13 Index X12 Percentage single males

Fig. 3.13/1 Percentage eligibles on the roll

Fig. A.32 Percentage adult aliens (see also Fig. 3.11/2)

Appendix B: Age pyramids.

3.5.1 Areas of underestimate (negative) by the electoral rolls

Short-fall in electoral change as compared with intercensal population change is likely to be due to increases in those sections

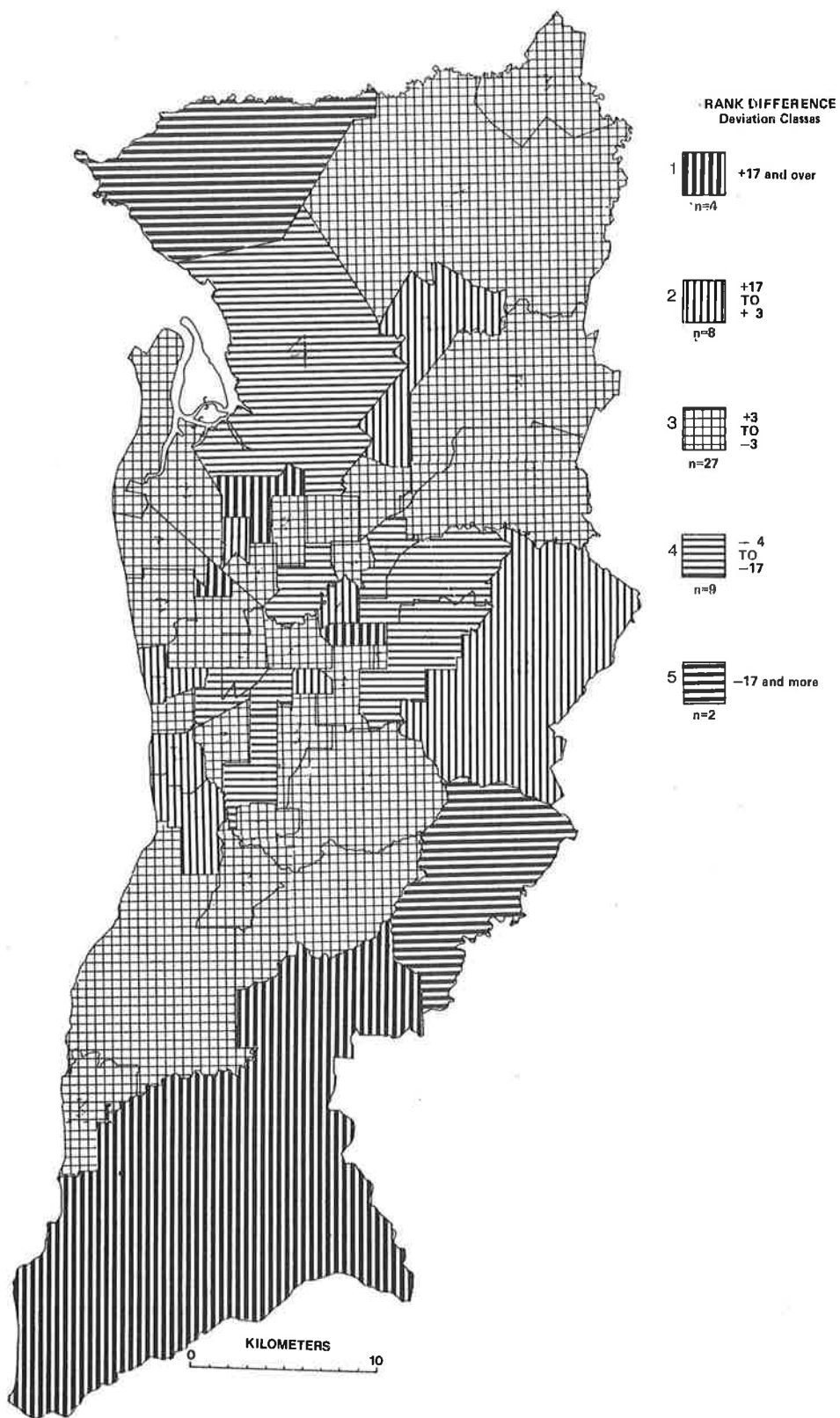

FIG. 3.10: Ranking Deviations of Electoral Change compared with Intercensal Change.

Sources: Computations by the author of data derived from (1) Censuses 1966 and 1971, Australian Bureau of Statistics. (2) State Electoral Dept., Adelaide, 1970-71.

of the population which, for various reasons, are not eligible to register as electors. These increases may be accounted for by the following three circumstances.

(a) High birth rates increase the population of an area without increasing the number of electors (see maps Figs. A.5 and A.6). This is the case in Salisbury (S.D. 745), Goyder (S.D.823), Coles (S.D. 811) and Gilles East (S.D.813).

(b) High intake of non-naturalized persons (aliens) increases the population but not the number of electors in an area (see maps Fig. 3.11/2 and Fig. A.32). This is the case in Goyder (S.D.823), Marleston (S.D.775), Goodwood (S.D. 773), St. Peters (S.D.715), Coles (S.D.811) and Gilles East (S.D.813).

(c) High intake of persons under 21 years increases the population without increasing the number of electors (see maps Fig. A.12 and Fig. A.13 and Appendix B, age pyramids). This occurs especially in areas with high concentrations of flats or accommodation for students or other young people, such as Hanson East (S.D.774), Bragg (S.D. 751), Torrens (S.D.716), and to a smaller extent, Mitchell (S.D.776).

Goyder (S.D.823) with a rank difference of 31 has a high proportion of resident aliens who by definition are ineligible to be electors, has a high child-woman ratio, a high birth rate and only a moderate rate of naturalization of aliens. All these factors contribute to the total population increasing much more rapidly than the electoral population which is therefore a relatively less reliable predictor of changes in the former.

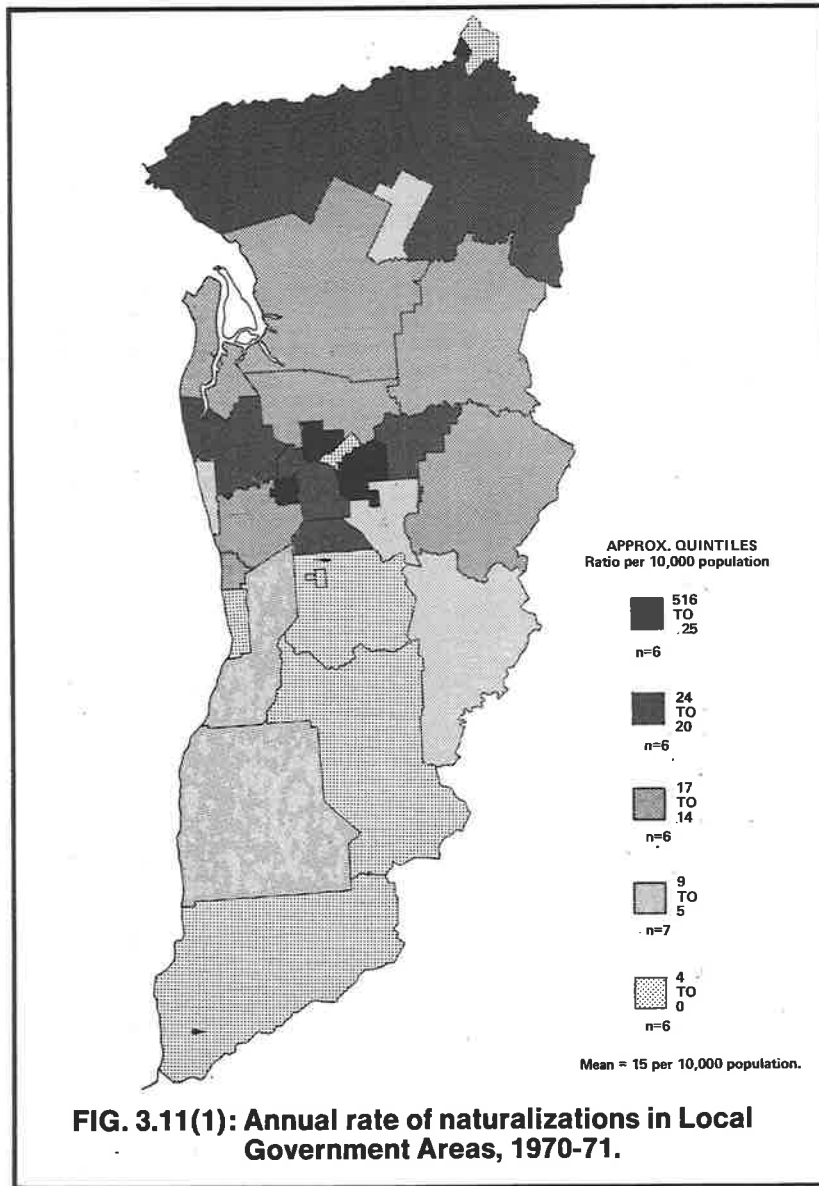

FIG. 3.11(1): Annual rate of naturalizations in Local Government Areas, 1970-71.

Sources: Australian Dept. of Immigration, and Australian Bureau of Statistics.

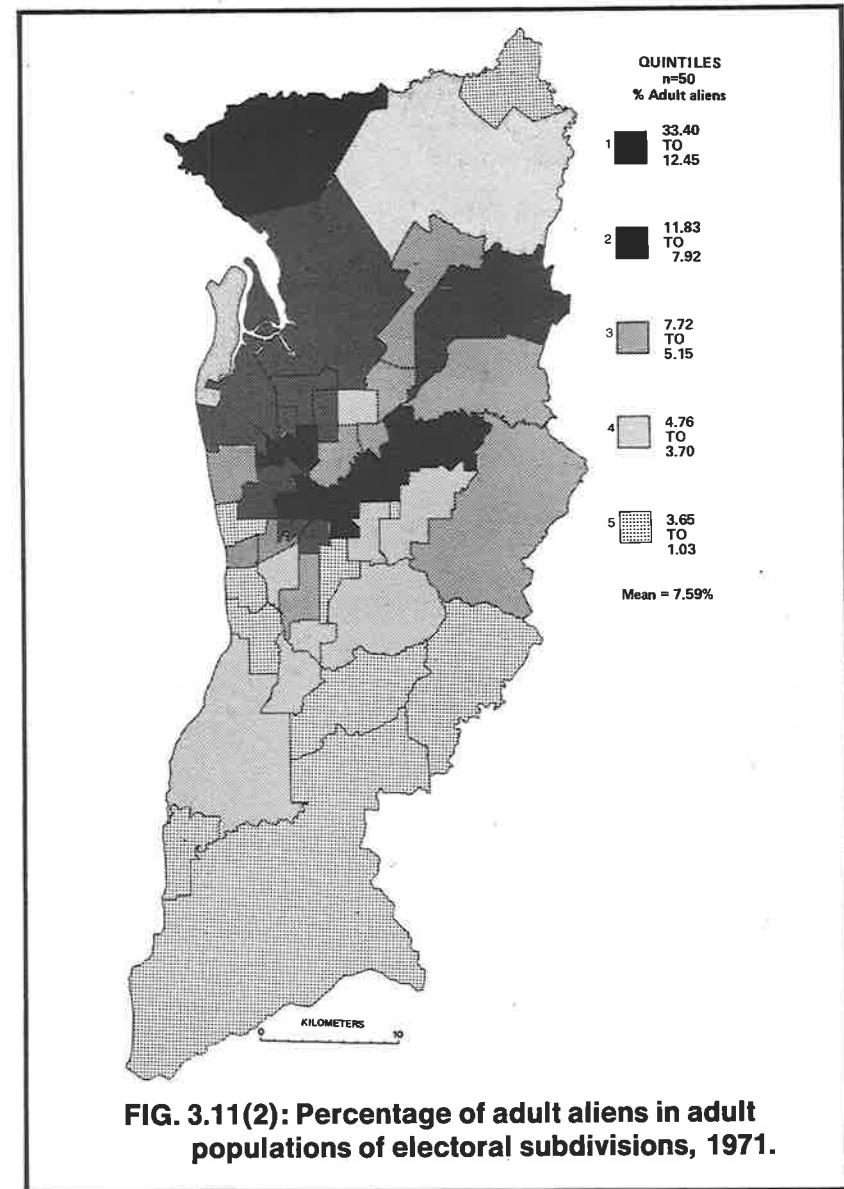

FIG. 3.11(2): Percentage of adult aliens in adult populations of electoral subdivisions, 1971.

Sources: Australian Dept. of Immigration, and Australian Bureau of Statistics.

3.5.2 Areas of overestimate (positive) by the electoral rolls

This occurs in areas where change in the electoral population is at a greater rate than in the total population. Electoral numbers may increase relatively faster than the population when people already resident there and counted in the census become registered electors under the circumstances outlined below.

(a) Eligible persons already resident in an area and turning 21 years of age add to the electoral roll without increasing the population. This has occurred in moderately long-settled suburbs built up in the 1950's during the post-war building boom, such as Brighton (S.D.791), Hanson (S.D.793), Glenelg (S.D.792), Beverley (S.D.781), Angle Park (S.D.802), and Spence North (S.D.805), (see age pyramids, Appendix B).

(b) Overseas migrants (aliens) residing in an area are included in the census count but on becoming naturalized they are added to the electoral roll without an increase in population. See the accompanying map, Figure 3.11. Areas affected in this way are Beverley (S.D.781), Spence North (S.D.805), Angle Park (S.D.802), Norwood (S.D.755), and possibly Light North (S.D.824).

(c) A high intake of adult-electors and a relatively low intake of children and aliens would have the effect of producing a closely similar count of population and electors but alter the relative ranking compared with other areas with a more "balanced" population. Areas like Unley (S.D.756), Norwood (S.D.755), Leabrook (S.D.753), and Fisher West (S.D.772) have high concentrations of flats and home

units which would encourage this trend.

(d) A strong outflow from an area of non-electors (such as young people to attend education or employment in more distant areas, or aliens) would have the result of reducing the census count without reducing the electoral roll. This may have taken place in the rural-urban fringe areas of Light North (S.D.824), Heysen North (S.D.724), and Alexandra (S.D.730), but at present this is hard to substantiate.

3.5.3 Areas of general agreement on population change

It has been assumed so far in the discussion that the 29 subdivisions where rankings on the two scores deviated by less than four, have population change well approximated by changes in electoral numbers.

However, it is important to point out the fact that the census information covers changes over a five year span, thereby masking any trends which may have originated toward the end of that time. The electoral figures, with which comparison is being made, were derived from the last fifteen months of the same period and therefore may indicate trends not yet apparent in the census figures. Of course, observed changes could be, equally well, brief local variations of a temporary nature. The following questions are posed as examples of interpretative uncertainties:

(a) Is the positive increase registered in Norwood (S.D.755) on the roll an indication that the earlier decrease in population has been slowed down or even reversed?

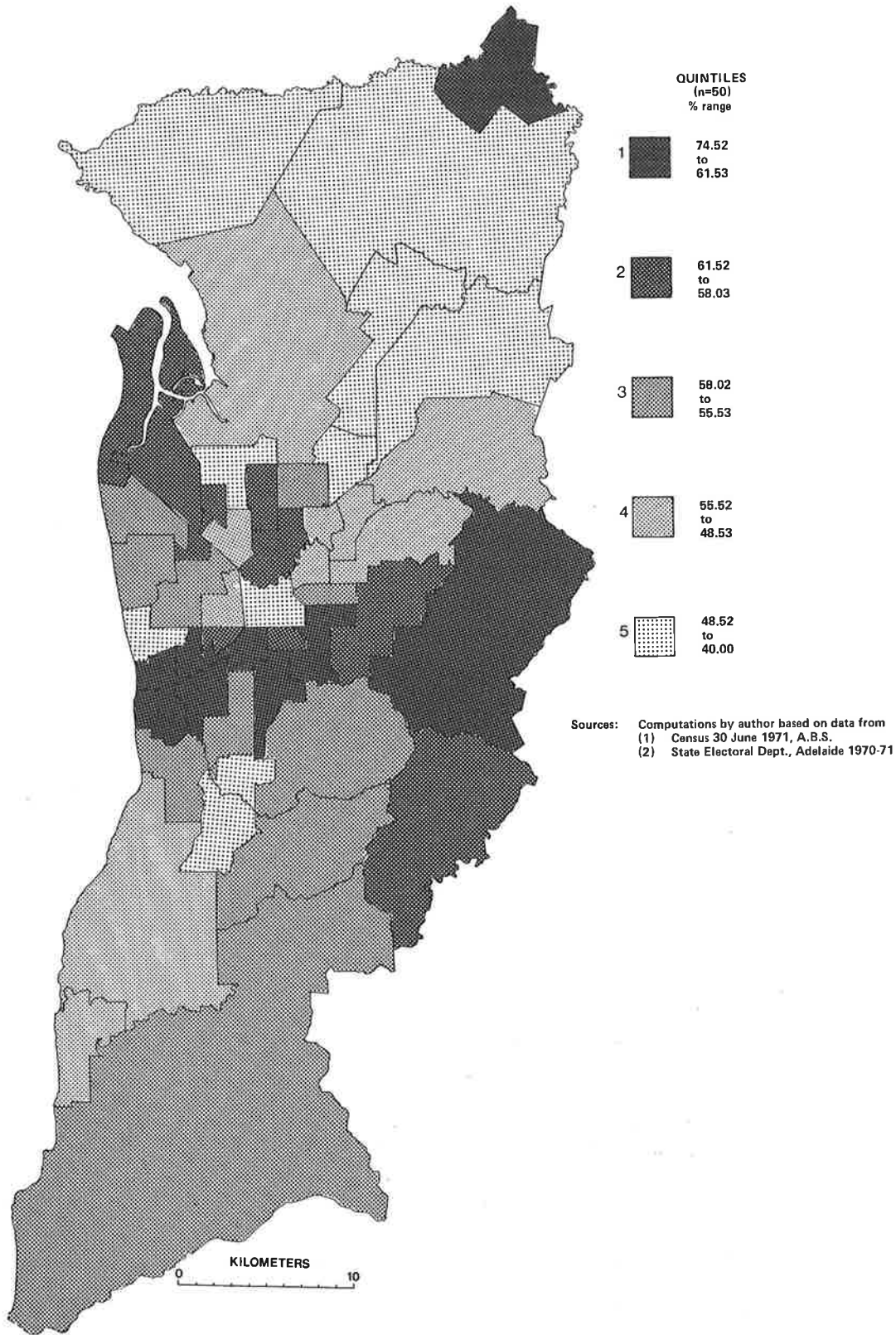

FIG. 3.12: Percentage of electors in total population in electoral subdivisions, 1971.

Sources: Computations by author based on data from (1) A.B.S. Census, 30 June 1971.
 (2) State Electoral Dept., Adelaide 1970 - 1971.

(b) Is the change from positive to negative in Fisher East (S.D.722) indicative of a recent acceleration in population out-movement? Is the incoming population mainly non-voters?

(c) Do areas, such as Adelaide (S.D.711), Florey West (S.D.712), and Ross Smith (S.D.714), which experience a greater population loss according to the census than the electoral rolls, in fact have a stronger net outflow of non-voters, that is, children and aliens?

The fact that registered electors constitute only a portion of the total population has been commented upon already (section 2.3) and will continue to enter discussion as a factor of some importance. Furthermore, it is to be expected that there will be considerable spatial variation in the relative size of the group so designated. Figure 3.12 maps for Adelaide the proportion of the total population registered as electors in each subdivision. Such variation derives primarily from locational differences in population age structures which are discussed later and represented graphically in Appendix B and Appendix C.

An important assumption which so far has remained implicit in discussion is now to be stated and examined closely. The assumption has been that those people eligible to register as electors do so in all subdivisions in approximately equal proportions. If this is not the case, then a further complication is superimposed upon the explanations discussed above of the observed differences between rates of change as measured by census and by electoral roll counts.

3.6 PERCENTAGE OF ELIGIBLES IN THE POPULATION WHO ARE ON THE ELECTORAL ROLL

Hugo (1971a, p.78) showed that in the four non-metropolitan Commonwealth Electoral Divisions, the percentage of eligible persons actually registered on electoral rolls was as follows.

TABLE 3.4

Percentage of Eligible British Nationals₁ Registered as Electors in Non-metropolitan Electoral Divisions, June 1966.

Division	Percentage eligible persons ₂ registered on electoral roll	at date
Angus	94.84	10/6/66
Barker	93.26	7/6/66
Grey	90.37	26/6/66
Wakefield	99.45	3/6/66
Non metropolitan total	94.48	

- Notes: 1. Population as at the census, 30th June, 1966
 2. Eligible persons are British Nationals aged 21 years and over

Source: Hugo (1971a, p.78) - special tabulations provided by A.B.S., Adelaide.

The fact that values cover such a small range would seem explicable in terms of minor differences in elector behaviour in the different areas. For example, Grey contains large industrial towns with a high population turnover in contrast to Wakefield, a stable prosperous primary producing area. A full 100 per cent registration cannot reasonably be expected because of a time-lag built into both the residential qualification for electors (see Section 3.7.2 and Ward, 1975) and the procedures in roll maintenance. The problem

TABLE 3.5

PERCENTAGE OF ELIGIBLE PERSONS ACTUALLY REGISTERED ON SUBDIVISIONAL ELECTORAL ROLLS AND ADJUSTMENTS TO

CODESUB-DIVISION NO.	MINIMIZE ANOMALIES														Rank	Rank
	1.	2.	3.	4.	5.	6.	7.	8.	9.	10.	11.	12.	13.	14.		
	Electors roll at 11/6/71	Brit. Nat. at census 30/6/71	Eligible Col. 1 Rank	Difference Col. 2 minus Col. 1	Out-Visitors* Electorals ADD to Col. 2	In-Visitors* B.N.	Col. 5 minus Col. 6 plus Correction to Col. 7	Adjusted B.N. at census Col. 8 minus Col. 7	Difference Col. 8 minus Col. 1	Adjusted Eligible Col. 1 Rank	Rank	SPLIT C.D. Tot. C.D. and Pts.	Pop. of Split	% of B.N. in the Adult Population	Rank	
	71 - ADELAIDE															
711 ADELAIDE	3 601	5 594	64,37 50	+ 1 993	256	975	- 719	4 875	- 1 274	73.87	50	0/33	NIL	17.73	6	
712 FLOREY WEST	9 725	9 604	101,36 15	- 131	409	372	- 37	9 641	- 94	100.98	6	1/21	49	4.76	32	
713 GILLES WEST	6 838	6 847	99,86 22	+ 9	390	205	185	7 032	194	97.24	20	0/16	NIL	7.72	21	
714 ROSS SMITH	11 760	11 482	102,42 8	- 278	616	420	196	11 678	- 82	100.70	7	1/32	106	8.47	17	
715 ST. PETERS	7 873	8 329	94,52 40	+ 456	568	369	199	8 528	655	92.32	40	0/23	NIL	14.58	5	
716 TORRENS	15 701	16 800	93,45 42	+ 1 099	404	1 609	- 205	16 595	894	94.61	34	2/45	69	6.67	23	
72 - ANGAS (PART)																
722 FISHER EAST	4 117	4 133	99,61 26	+ 16	268	130	138	4 271	- 154	96.39	23	2/18	33	1.03	50	
724 HEYSEN NORTH(part)	2 537	2 139	118,60 1	- 398	295	17	278	2 417	- 120	104.96	1	4/12	133	5.56	28	
73 - BARKER (PART)																
730 ALEXANDRIA (part)	2 436	2 599	93,72 41	+ 163	180	31	149	2 748	- 312	88.65	44	3/18	50	3.13	45	
731 FISHER SOUTH	688	740	92,97 43	+ 52	50	11	39	779	91	88.32	46	3/5	45	1.73	49	
732 FLAGSTAFF HILL	1 326	1 673	79,25 49	+ 347	79	28	51	1 724	- 398	76.91	49	3/6	68	4.24	37	
736 MOANA	1 008	1 131	88,96 47	+ 123	56	22	34	1 167	- 159	86.38	47	2/8	6	2.83	47	
74 - BONYTHON																
741 ELIZABETH	15 459	15 861	97,46 34	+ 402	748	524	224	16 085	- 626	96.11	26	8/41	198	4.53	34	
742 FLOREY EAST	8 211	9 170	89,54 46	+ 959	293	299	94	9 264	- 1 053	88.63	45	1/21	22	6.67	23	
743 MDOBURY NORTH	5 456	5 654	96,49 36	+ 198	375	88	287	5 941	- 485	91.64	41	4/15	106	9.01	16	
744 PLAYFORD	16 933	17 301	97,87 32	+ 368	1 113	388	725	18 026	- 1 093	93.94	37	8/44	221	5.68	27	
745 SALISBURY	14 361	14 163	101,39 13	- 198	718	288	430	14 593	- 232	98.41	15	5/37	153	8.16	18	
75 - BOUTHBY																
751 BRAGG	15 369	16 879	91,05 44	+ 1 510	1 417	978	439	17 318	- 1 949	88.75	43	10/49	251	4.59	33	
752 FISHER NORTH	9 118	8 871	102,78 7	- 247	623	269	354	9 225	- 107	98.84	13	5/27	205	4.44	36	
753 LEABROOK	1 442	1 325	100,83 3	- 117	139	11	97	1 422	- 24	101.41	5	2/4	82	3.29	43	
754 MITCHAM	15 840	15 607	101,49 12	- 233	1 309	471	833	16 440	- 600	96.35	24	7/44	371	3.10	46	
755 NORWOOD	8 217	8 537	96,25 38	+ 320	709	359	350	8 807	- 670	92.46	39	0/22	NIL	12.99	9	
756 UNLEY	6 463	6 565	98,44 31	+ 102	548	332	216	6 781	- 318	95.31	30	2/19	63	13.61	7	
77 - HAMMER																
771 ASCOT PARK	15 670	15 307	102,37 9	- 363	973	437	536	15 843	- 533	98.91	10	1/38	36	4.15	38	
772 FISHER WEST	2 399	2 613	85,28 48	+ 414	164	66	98	2 911	- 512	82.41	48	3/7	122	3.70	40	
773 GOODWOOD	9 168	9 368	97,86 33	+ 200	745	371	374	9 742	- 574	94.11	36	0/24	NIL	9.08	15	
774 HANSON EAST	7 577	7 638	99,20 27	+ 61	500	200	100	7 938	- 361	95.45	28	2/19	124	5.86	25	
775 MARLETON	4 425	4 648	95,20 39	+ 223	329	319	10	4 658	- 233	95.00	32	2/12	64	7.92	20	
776 MITCHELL	15 944	15 850	100,59 19	- 94	944	552	392	16 242	- 298	98.17	17	3/36	155	5.15	30	
78 - BINDMAKSH																
781 BEVERLY	3 654	3 517	103,89 5	- 137	185	132	53	3 570	- 84	102.35	2	4/10	168	12.95	8	
782 HANSON NORTH	2 424	2 690	90,11 45	+ 266	167	160	7	2 697	- 273	89.88	42	1/7	19	3.65	41	
783 BENLEY BEACH	17 053	16 978	100,44 20	- 75	825	426	399	17 377	- 324	98.14	18	1/40	29	7.43	22	
784 PEAKE	15 692	15 730	99,75 24	+ 38	946	435	511	16 211	- 519	96.62	22	4/36	161	11.83	11	
785 SPENCE SOUTH	9 339	9 053	103,15 6	- 286	509	764	245	9 298	- 41	100.44	8	3/29	122	17.83	3	
786 THEBARTON	8 459	8 381	100,93 18	- 78	623	299	324	8 705	- 246	97.17	21	1/26	46	18.69	2	
79 - KINGSTON																
791 BRIGHTON	16 615	16 781	99,01 29	+ 166	1 087	392	695	17 476	- 861	95.07	31	4/39	190	3.48	42	
792 GLENELG	16 570	16 615	99,72 25	+ 45	1 196	614	582	17 197	- 627	96.35	24	2/42	75	2.58	48	
793 HANSON SOUTH	7 350	7 578	96,99 35	+ 228	489	362	127	7 705	- 355	95.39	29	1/20	40	5.83	26	
794 MANSON	16 613	17 227	96,43 37	+ 614	898	419	479	17 706	- 1 093	93.83	38	8/43	184	4.46	35	
80 - PORT ADELAIDE																
801 ALBERT PARK	12 420	12 528	99,13 28	+ 108	609	579	30	12 558	- 138	98.90	11	4/29	182	9.64	14	
802 ANGLE PARK	3 636	3 586	101,31 16	- 50	196	106	90	3 676	- 43	98.83	14	3/11	252	10.08	13	
803 PRICE	16 181	16 011	101,06 17	- 170	860	635	225	16 236	- 55	99.66	9	3/43	150	10.98	12	
804 SEMAPHORE	16 655	16 684	99,82 23	+ 29	803	643	160	16 844	- 189	98.88	12	2/44	42	4.76	31	
805 SPENCE NORTH	6 378	6 068	105,10 4	- 310	353	187	166	6 234	- 144	102.31	3	7/19	185	8.12	19	
81 - STURT																
811 COLES	17 311	16 944	102,16 10	- 367	1 145	460	686	17 630	- 319	98.19	16	2/44	33	14.73	4	
812 DAVENPORT	14 924	14 906	100,12 21	- 18	1 341	440	901	15 807	- 883	94.41	35	3/37	71	4.14	39	
813 GILLES EAST	9 114	8 990	101,37 14	- 124	516	213	301	9 291	- 179	98.07	19	2/21	113	12.45	10	
814 HIGHTBURY	13 295	13 485	98,59 30	+ 190	612	278	554	14 039	- 744	94.70	33	3/36	135	5.44	29	
82 - WAKEFIELD(PART)																
823 GOYDER (part)	586	532	110,15 2	- 54	42	1	41	573	- 13	102.27	4	2/3	110	37.40	1	
824 LIGHT NORTH(part)	4 525	4 450	101,68 11	- 75	361	85	276	4 726	- 201	95.75	27	2/14	30	3.14	44	
TOTAL ADELAIDE STATISTICAL DIVISION	468 463	475 364	98.55	+6 901	30 287	17 295	12 995	488 359	19 896	95.93		148/1289	5 069	7.59		

NOTES:

Col. 2 Brit. Nat. (B.N.) = British Nationals aged 21 years and over are those eligible to register as electors.

Col. 5 Out-Visitors = Electors absent at census = (total absent votes plus postal votes) X $\frac{(100 - \text{rate of electors})}{100}$

Col. 6 In-Visitors = visiting B.N. = (persons not in usual residence) X (% host population B.N.) at census

SOURCES: (1) STATE ELECTORAL DEPT., ADELAIDE

(2) COMMONWEALTH BUREAU OF STATISTICS, ADELAIDE.

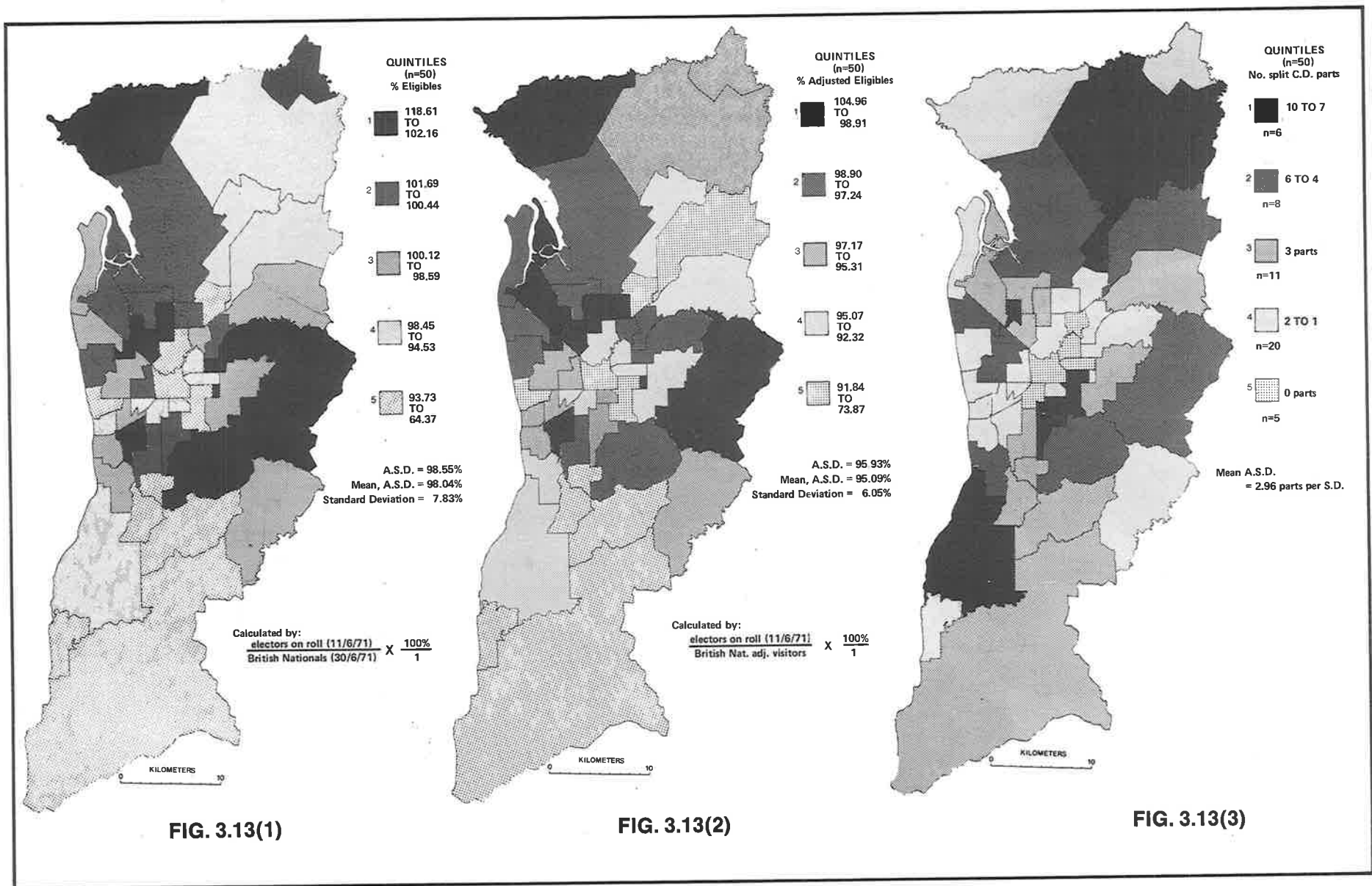
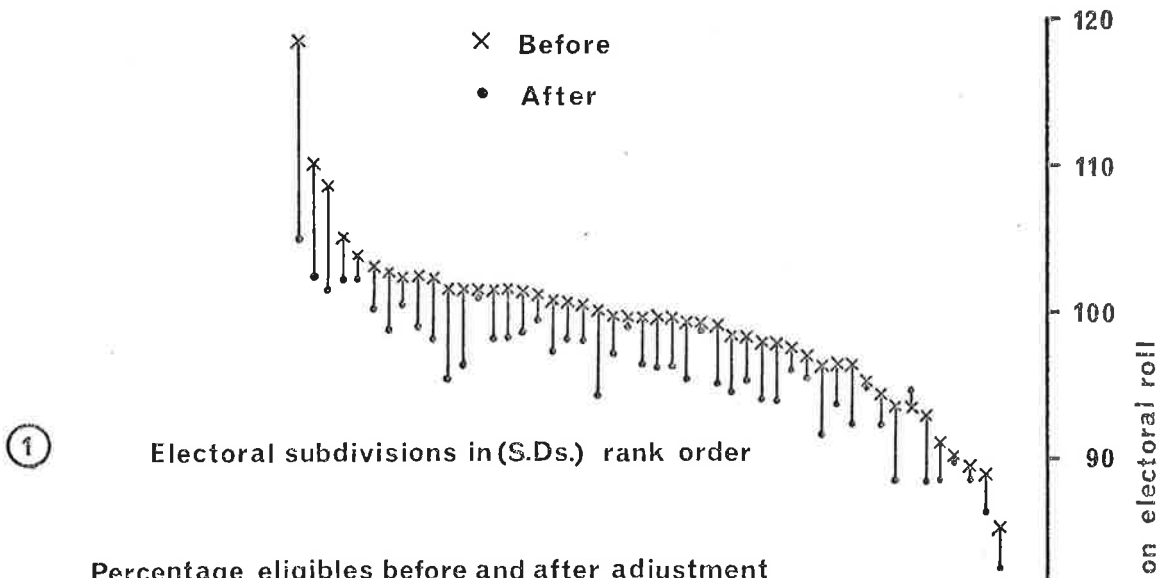

FIG. 3.13: Comparison of spatial distributions of (1) percentage of eligible persons registered on electoral rolls (2) percentage after adjustment to minimize anomalies, and (3) number of fragmented census collector districts.
 Sources: State Electoral Dept., Adelaide and Australian Bureau of Statistics.

of time-lag is discussed later in some detail. A further loss occurs because a small number of British Nationals of appropriate age are otherwise disqualified through unsoundness of mind or by being inmates of prisons or holders of temporary entry permits. Nevertheless the registration rates quoted above have been taken to indicate that electoral rolls in S.A. include a high proportion of those eligible to appear on them. However, since the data gathered by Hugo was only for non-metropolitan areas it was clearly pertinent that the present study of the Adelaide area should include information of a similar kind specific to the study area. The accompanying Table 3.5 (column 3) sets this out for the fifty electoral subdivisions of the Adelaide Statistical Division. Figure 3.13/1 maps the distribution in quintiles.

A remarkable feature is that twenty-one of the fifty subdivisions show more than 100 per cent of eligible persons are on the rolls. Such a seemingly impossible result would appear at first to cast serious doubts upon the reliability of the data. In these circumstances, if it is the accuracy of the comparative figures on electoral registration which is doubted, then it follows that one must also question the ability of electoral data to yield reliable information on intra-urban migratory movements as attempted in this study. It is thus of basic importance that a satisfactory explanation be found for the apparently anomalous nature of the results listed in column 3 of Table 3.5. The graph (Figure 3.14/2) shows among other things the distribution of the unadjusted percentages among the electoral subdivisions.



Percentage eligibles before and after adjustment

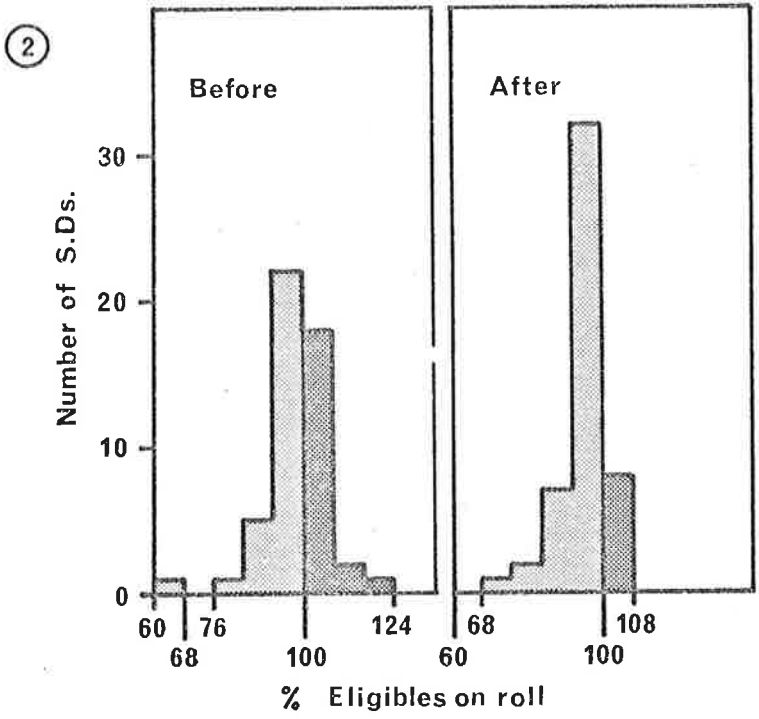

FIG. 3.14. Effect of 'adjustment' on percentage of eligibles on electoral subdivision rolls.

3.6.1 Search for estimates of error

The two information elements used in the initial calculation for each electoral subdivision were:

$$\frac{\text{number of electors on the roll at 11/6/71}}{\text{number of British Nationals 21 years and over at census 30/6/71}}$$

Logically the numerator cannot be challenged for accuracy in this context, but note should be taken however of the fact discussed elsewhere (see Section 3.7.2 and Ward, 1975) that weeks and sometimes even months may pass before an elector's residential movement in or out appears on the roll. The second element, on examination for possible error, was found to have three main sources of distortion.

- (a) Some people enumerated at census were "not in usual place of residence" and their presence as IN-VISITORS thus inflated the local census count.
- (b) Registered electors who were absent from their "usual place of residence" at census were not included in their local count, which was therefore deficient of its OUT-VISITORS.
- (c) In this present study the process of amalgamating Census Collector's Districts to obtain population data for areas equivalent to Electoral Subdivisions necessitated some cases of estimation. This involved estimating fractions of certain individual C.D.s in the small proportion of cases where they were cut by electoral boundaries. Possible error resulting from such estimates was influenced by both the number of C.D.s to be split in a given subdivision and the size of the total population involved.

The sources of distortion listed above are now discussed in detail especially with regard to data suitable as indicators of the level of distortion.

3.6.2 In-Visitors as Inflators of Population Numbers

The 1971 census distinguished each enumerated person as either "a usual resident of this dwelling" or a visitor. The difference between the total census population and "usual residents" yields the number of "in-visitors". However for present purposes not all in-visitors are British Nationals aged 21 years and over. Unfortunately no cross-tabulation was available to determine the number from this subgroup which had been included in the original denominator. The best way of dealing with this source of error was to assume that the proportion of in-visitors eligible to be electors was the same as in the host population of the subdivision. Based on this assumption, adjustment for each subdivisional count of those eligible to be on electoral rolls was made as follows:

(British Nationals 21 years and over) deduct (persons not in usual residence, multiply by percentage of host population British Nationals 21 years and over). The in-visitor estimate is shown in column 6 of Table 3.5.

3.6.3 Out-Visitors as depletors of eligible population numbers

Useful to this study is the fact that when elections are held registered electors fall into the following three broad categories according to general voting behaviour:

- (a) Those who vote within their home subdivision (and so probably would have been at home to complete a census return)

(b) Those who failed to vote (and whose presence or absence from home is unknown)

(c) Those who cast either postal or absent votes (Most of the voters in this category were presumably absent from their usual place of residence and are here taken as a representative sample of those who would be absent at the time of a census)

Accordingly, electoral records were consulted for the compulsory polls held on 30th May 1970, 19th Sept. 1970 and 10th March 1973. The first of these yielded the lowest percentage of non-voters and was used therefore as an indication of the number of electors who might be expected to be away from "usual place of residence" during a census. It was assumed that non-voters included in their number some who would have claimed either absent or postal votes had they voted. In addition it was assumed that the proportion doing so would be the same as that for voters. A further refinement was made because the census was held about one year after the 1970 election. Therefore the count of out-visitors was multiplied by the annual rate of change of the total electors in each subdivision. The following summarizes the derivation of the estimated number of out-visitors.

$$(\text{Total absent and postal votes}) \times \left(\frac{100}{\% \text{ who vote}} \right) \times (\text{annual growth rate of electors})$$

This result is shown in column 5 of Table 3.5.

The difference between the estimated number of in and out visitors determined the extent to which the denominator in the original calculation of percentage eligibles on the roll should be

corrected by increase or decrease. The actual size of this possible adjustment is shown in column 7 of Table 3.5. Column 8 shows the corrected estimate of British Nationals 21 years and over normally resident in each subdivision and column 10 the corrected percentage of eligibles registered as electors. In all cases a more logical figure has resulted. However, despite this, there remain eight subdivisions with scores still in excess of 100 per cent. The map Figure 3.13/2, shows for S.D.s the adjusted percentages on the electoral rolls. The graphs in Figure 3.14/1 and 3.14/2 show the statistical effect of the adjustments on both the individual S.D.s and the overall distribution.

3.6.4 Influence of Split Census Collectors Districts

Mention has been made already of the problem involved in amalgamating census collector's districts to cover territories identical with each electoral subdivision. The accompanying table shows in column 11 the total number of fragments where estimation of population was necessary. For mapping purposes, subdivisions were grouped according to the number of such fragments they contained. This is the basis of the map in Figure 3.13/3. Column 12 of Table 3.5 shows for only the split areas 10 per cent of the estimated number of British Nationals 21 years and over contained within them. The notion involved here is that an estimation error of this order could have occurred. Therefore a trial comparison of this possible error with the outstanding margin of the electorally eligible can demonstrate whether the anomaly

may be thus explained.

In attempting to explain the eight cases where even the adjusted scores for registered electors still exceed 100 per cent, the question is what size error in estimation of fractions of split C.D.s would cover the remaining margin. The required minimum error values for each S.D. are as follows: 1½% (823), 2½% (753), 3% (785), 5% (781), 7% (805), 8% (714), 9½% (724), and 18% (712). In all but one case then an error margin of less than 10 per cent could explain the remaining apparently excessive registration rate. In the worst case (S.D. 712) the presence of a large public hospital complex probably ensures that much more than the usual local percentage (54.3) of in-visitors is in fact British Nationals 21 years and over. An absolute error of only 50 to 100, out of 665 in-visitors, would be necessary to correct this.

After compensating in the way described for the various distortions it seems then that the proportion of eligible residents who are actually registered on the fifty electoral rolls varies between about 70 and 99 per cent, while Adelaide Statistical Division as a whole has a rate of 95.9 per cent, slightly higher than that described for non-metropolitan areas in 1966 by Hugo (1971a).

Reference was made earlier to the existence of a variable time-lag between the physical transfer of a person and the electoral registration of that move. This is discussed later (section 3.7.2) as yet another possible factor in the kind of

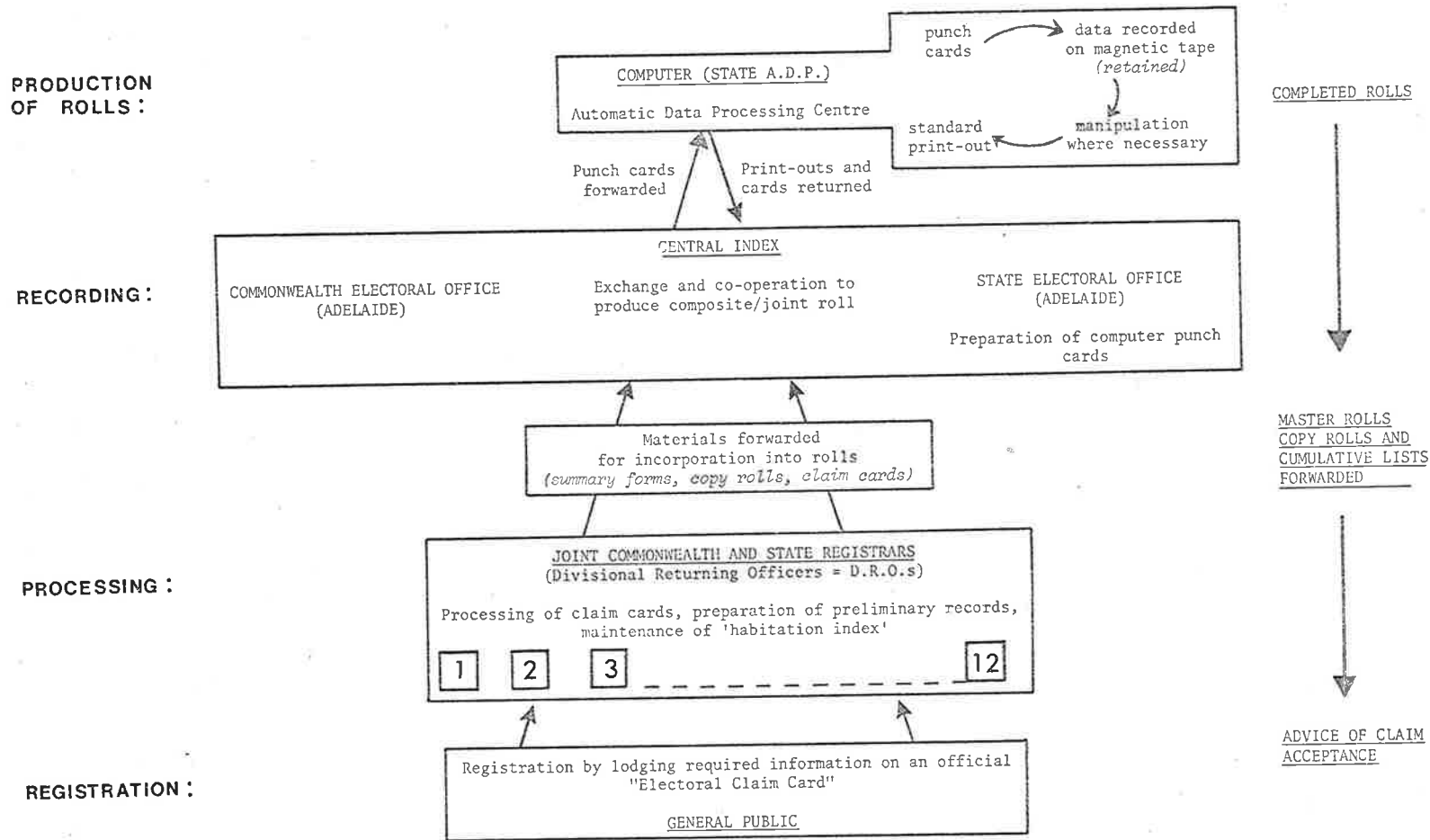

FIG. 3.15: Flow within electoral offices of information lodged by members of the general public. Compiled from information supplied by State Electoral Dept., S.A.

discrepancy just examined. The link between levels of electoral registration and population mobility as measured by rates of net migration and population turnover is reviewed in the next chapter (section 4.3.3).

Having taken the decision to study population mobility with data from electoral rolls, the thrust of the argument so far may be summarized as follows. When compared with the census on measures of population trend the results were not significantly different. Further analysis of population data is conducted on the assumption that the two systems are sufficiently alike to allow generalization. Spatial variation in registration rates of persons eligible to register have been described and explained.

It is appropriate now to describe the electoral rolls and the manner of their operation and define certain terms. This will make clear the flexibility and limitations of the data which is being used here for a purpose for which the system was never intended.

3.7 FEATURES OF ELECTORAL REGISTRATION IN SOUTH AUSTRALIA

Both the Commonwealth and the State governments have departments responsible for implementing their respective electoral acts. They have co-operated to rationalize operations and now produce a composite roll from the pooling of resources. The structure of relationships is shown diagrammatically in Figure 3.15 which illustrates the flow of information supplied by a member of the public when lodging a claim card.

3.7.1 Categories of electors

Although there are minor legal differences between electoral requirements laid down by the various Australian states and the Commonwealth government, it is the latter which effectively prescribes most limitations in practice. Under Commonwealth law it is compulsory for all eligible persons to register as electors and to supply correct information. Eligible persons are aged at least 21 years (since March 1973 includes all over 18 years) and British subjects (i.e. by birth or naturalization are Australian citizens or citizens of any member country of The Commonwealth of Nations) who having lived in Australia for a minimum period of six months "are not of unsound mind, convicted and under sentence for any offence punishable by imprisonment for one year or longer, attainted of treason or holders of temporary permits under the Migration Act" (Aitchison, 1969, p.50. A rewording of C.E.A., part VI, ss.39).

At intervals of approximately a year "review campaigns" are held during which every entry in the roll is checked by door-to-door visitation based on the "habitation index" maintained by each divisional returning officer (Figure 1.). New claim cards are left with the hundreds of electors normally found to be inaccurately registered. Such campaigns ensure that a high proportion of electors appears correctly on the rolls. Hugo (1971a, pp.78,79) showed that the percentage of eligible persons registered as electors during June 1966 varied in the four non-metropolitan divisions from 90.37 per cent to 99.45 per cent (see also section 3.6).

Both the level of accuracy of the completed records and the volume of transactions handled vary considerably through time because reviews are held at irregular intervals, a point to be considered when temporal comparisons are made.

At no time, of course, is there any ready check on the absolute accuracy of all information supplied by the claimant. As in the census the information is accurate to an indeterminable degree according to the co-operation and honesty of the respondent.

3.7.2 Problem of "time-lag"

According to the circumstances, when an elector changes his place of residence there are different length-of-residence requirements or periods for registration or correction to be complied with. The following are examples.

(a) British subjects (defined above) must have resided in Australia for at least six months,

(b) If an elector changes address within the same subdivision he must, by Commonwealth requirement, notify this within 21 days of the move.

(c) If an elector moves from his registered subdivision to a residence still within the Commonwealth of Australia he must live one month in the new subdivision before lodging his new Electoral Claim. This must be done within the next 21 days.

The rolls as a consequence lack immediacy as a record of the movements of the population, there being inevitable variability in the time-lag between people actually moving and registering their change

of address.

The electoral rolls, if taken as a record of the whole population, have particular bias because they exclude all non-British subjects (aliens), and those under 21 years of age (and more recently 18 years). Many minors, both married and single, live as independent householders or family units and thus are a significant part of the residential movement patterns of society. Others not on the electoral roll are of course assumed to be dependents accompanying registered electors. Nevertheless, it is inevitable that an indeterminate number of those eligible to register fail either to have their names recorded at all or to have all their moves recorded. These deficiencies arise either because the individuals concerned are highly mobile or because they deliberately seek to evade the system (see Hugo, 1971a, pp.78,79).

3.7.3 Electoral Units

Within the various limits placed upon them at times of redistribution electoral commissioners devise boundaries so that the electorates contain approximately equal numbers of electors who are judged to possess a degree of homogeneity called "community of interest", an attribute difficult to define and identify. Although separate and independent systems of electorates exist for the Commonwealth and State governments with few common boundaries they represent a kind of hierarchy (see Table 3.6).

The accompanying map, Figure 3.16 shows the spatial arrange-

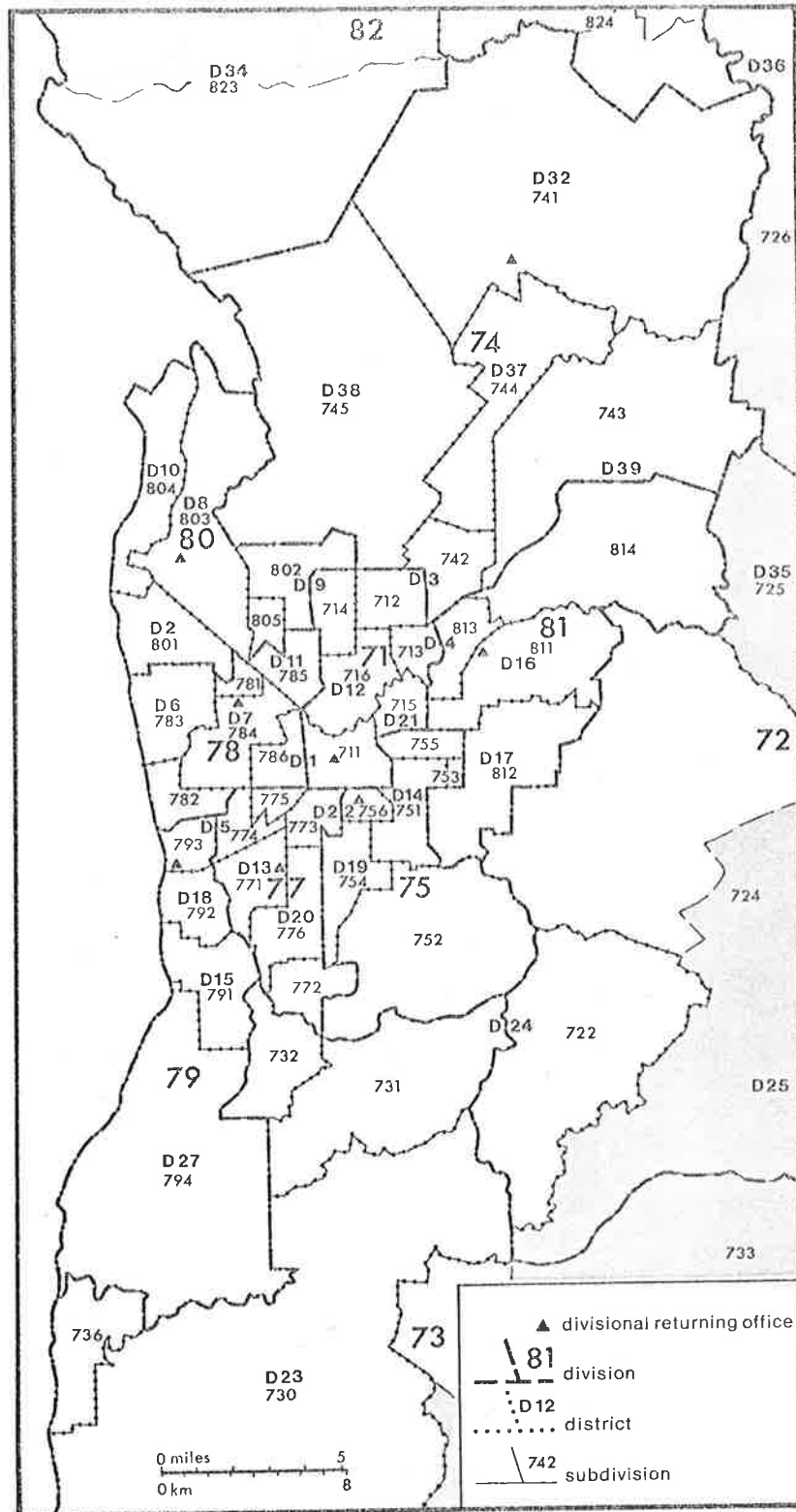

FIG. 3.16: Electoral divisions, districts and subdivisions, Adelaide Statistical Division, 1970. Source: R.E.C. 1969.

ment of electoral units in the study area.

Table 3.6

Comparison of S.A. Electorates for Commonwealth and State Governments,
March, 1970

Type of electoral unit	Number	Number of electors		
		Mean	Largest	Smallest
Commonwealth - Senate	1	632,212	632,212	632,212
State - Legislative Council*	5	52,313	75,515	31,690
Commonwealth - House of Representatives	(12)			
(DIVISIONS) - Metropolitan	8	54,907	56,037	52,315
- Non-metropolitan	4	48,239	50,273	45,289
State - House of Assembly#	(47)			
(DISTRICTS) - Metropolitan	28	15,921	16,838	13,841
- Non-Metropolitan	19	9,811	10,450	8,342

Source: Information supplied by State Electoral Dept. Adelaide.

* Subject to a selective franchise and voluntary enrolment.

The specific terms of reference for the Electoral Commissioners who devised the most recent redistribution are set out in R.E.C., 1969, Pt 1, pp.7,8. The differing formulae and quotas for the state, metropolitan, and country areas are set out in R.E.C., 1969, Pt 11, pp.13-7.

Electoral 'subdivisions' are the accidental fragmentary areas resulting from the superimposition of the two non-coincident sets of electoral boundaries. Although they vary greatly in the number of electors they contain, subdivisions are utilized as the basic recording unit, each having a separately bound roll of standard computer print-out. The range of sizes by electors enrolled is

shown in Table 3.7.

Logically the largest possible subdivisions occur where the State Assembly Districts are not cut by any other boundary so that the district and subdivision are one and the same. Subdivisions of smaller dimensions (there are several with enrolments of less than one thousand) arise therefore from the intersection of electorate boundaries.

Table 3.7

Comparison of S.A. Electoral Subdivisions, March, 1970

Number of electors in subdivision classes	Metropolitan	Non-Metropolitan	State total
under 1,500	4	3	7
1,500 - 2,999	2	1	3
3,000 - 4,499	6	1	7
4,500 - 5,999	0	0	0
6,000 - 7,499	6	2	8
7,500 - 8,999	5	4	9
9,000 - 10,499	3	13	16
10,500 - 11,999	2	0	2
12,000 - 13,499	1	0	1
13,500 - 14,999	4	0	4
15,000 - 16,499	11	0	11
16,500 and over	2	0	2
Total subdivisions	46	24	70
Mean electors	9,691	7,767	-

Source: Information supplied by State Electoral Dept, Adelaide.

3.8 COMPUTER HANDLING OF SOUTH AUSTRALIAN ROLLS

Since March 1968 South Australian electoral rolls have been maintained by computer. Planning and preparations began in mid-1965 as a State project but since August 1968 costs have been shared

with the Commonwealth (Douglass, 1971). The very considerable amount of "cleaning up" of records made necessary following computerisation indicates the degree of improved accuracy achieved. As a source of data in the study of population movement electoral rolls kept by computer techniques have several advantages over those kept by the old manual methods. The "time-lags" have been considerably reduced with the more frequent and more rapid production of both cumulative lists and updated rolls. The latter can appear within 24 hours of the issue of the writ for an election. Other advantages concern the accuracy of the record and include (1) built-in check procedures ensuring agreement of various tallies on print-outs (2) detection and correction of duplicated entries, an inherent problem with electoral rolls, (3) uniform presentation of information about the elector, and (4) checks for 'legality' against master lists of information supplied by electors. There are also improvements in the case of extracting data. For example the uniform accuracy of postcode and suburb allocation makes possible additional areal units smaller than subdivisions and by using special programmes data can be extracted, manipulated, and expressed automatically in forms suited to research needs.

3.8.1 Maintaining electoral rolls by computer

The system employed in South Australia uses standard punch cards of 80 column capacity. In every transaction involving an elector at least one card is punched to establish or alter his status on the roll. The flow-chart (Fig. 3.15) outlines the basic stages in official processing of elector information, thus suggest-

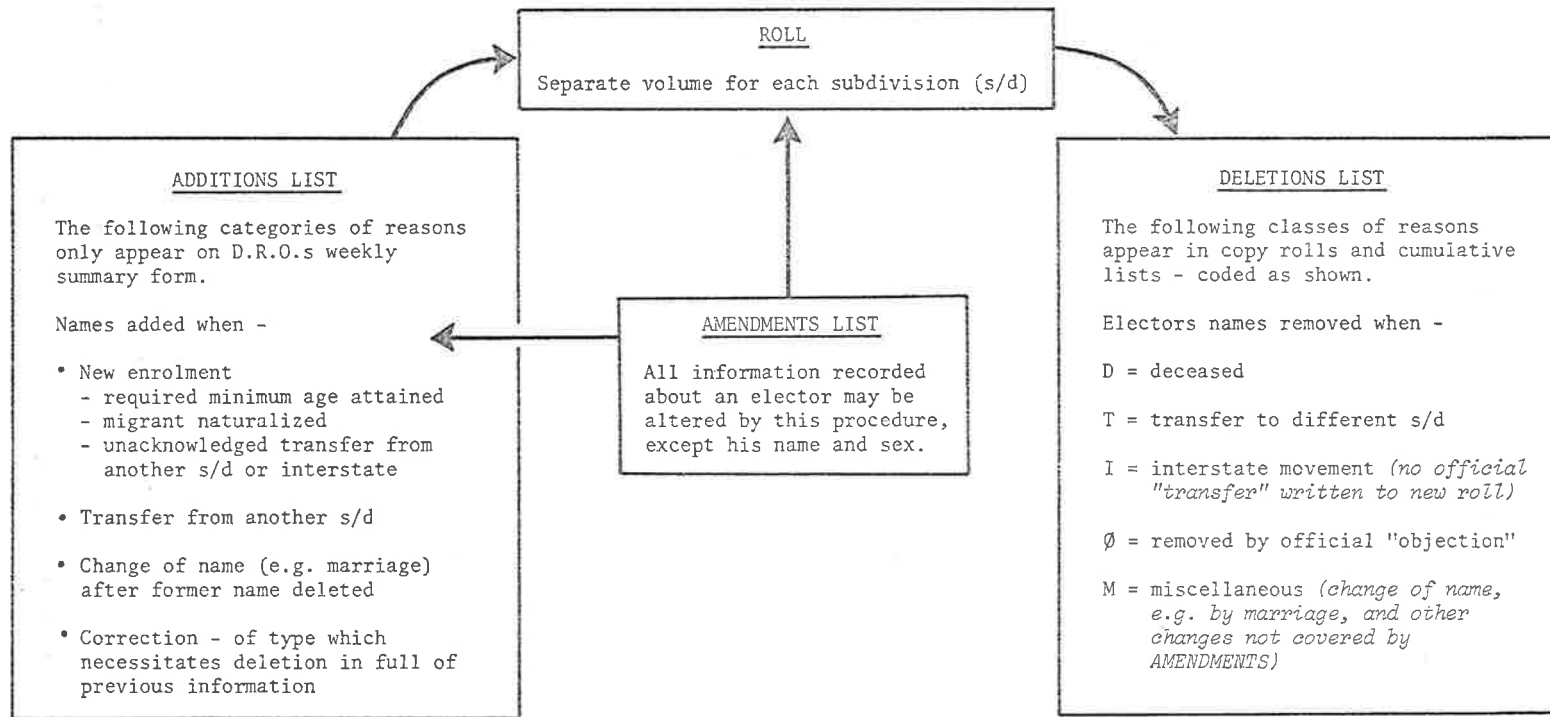

Throughout the life of each roll cumulative lists (which are officially part of the roll) are maintained separately for additions, amendments and deletions. These lists are themselves subject to continuing periodic addition, amendment or deletion, until at full up-date they are incorporated into new rolls.

FIG. 3.17: Classes of transactions made in the maintenance of S.A. composite electoral rolls. Compiled from information supplied by State Electoral Dept., S.A.

ing points at which the researcher may be able to extract data.

Two copies of the roll, known as the master and the copy, are of particular interest because of the way they are used in maintenance procedures. The master roll never leaves the premises of the Divisional Returning Officer (D.R.O.) who is responsible for its upkeep. The law requires that the corrected current roll be open at all times convenient to the D.R.O. for inspection by members of the public. In this volume amendments to and deletions of entries are made by hand. A separate cumulative list (computer print-out) of current additions is attached. The copy roll is a duplicate whereby information is transmitted between D.R.O. and head office for the preparation of punch cards to initiate changes in the rolls.

Punch cards prepared from copy rolls enable the preparation of cumulative lists for each of the three classes of transaction shown in Figure 3.17. It is by means of these alphabetic lists (or the initiating punch cards) that the most valuable data about population movement can be assembled.

3.8.2 Cumulative Lists

(a) Additions

Unfortunately the only record of reasons for additions is that contained on the weekly summary forms prepared by D.R.O.s where each new elector's full information appears. Only by the laborious inspection of these forms (which apparently are not consistently

preserved) could differentiation be made between those electors who have moved into the subdivision and those whose names appear for other reasons such as coming of age. Research based on sampling could perhaps indicate the proportion of additions resulting from immigration but this could be expected to vary so much from time to time in different subdivisions that any predictive value would be extremely localized.

(b) Amendments

The restricted range of information open to amendment in existing entries is shown in Figure 3.17. By considerable adaptation the amendments list can provide reliable information on changes of address within subdivisions. The problem for the researcher is to eliminate from a count of amendments all changes not indicative of a change of place of residence. Though it is likely that this could be done eventually by computer it has been achieved successfully only by manual operation as follows.

(i) By inspection of every amendment in the copy roll count only those where the house number and/or street name has been changed.

(ii) From the appropriate authorities (local government or D.R.O.) obtain details of any properties whose number or street names has changed during the life of the roll.

(iii) Deduct the count (ii) from (i). The result thus represents the number of electors who advise of moving place of residence within their subdivision.

(c) Deletions

Movement of an elector to an address outside his enrolled

subdivision is only one of several reasons why he may cease to be eligible for his name to remain on the subdivisional roll. Therefore the student of population movement is fortunate that both copy rolls and punch cards code classify deletions (Fig. 3.17).

The cards punched to implement removal of entries from the computer file provide in addition the destination subdivision of transfers. This makes possible the assemblage not only of general rates of out-migration but also comparison of different subdivisions as destinations.

A severe complication, however, arises from the fact that D.R.O. s are not always advised of deaths or transfers of electors. They do, nevertheless, from review campaigns, lists of non-voters after elections and other sources, eventually become aware of the likely ineligibility of a person to continue on the roll. Statements of intention to remove such names are mailed to known addresses and failure of the elector to prove eligibility leads to ultimate removal of his name. These are said to be removed by "objection".

It is clear that if the information about the elector were to hand all the deletions of this type could be allocated to one of the other listed categories. On the other hand, because of the lack of information, counts in each of these categories fall short of the correct figure by an unknown proportion of the objections count.

A check of objections was carried out in one inner suburban

subdivision with approximately 8000 enrolled electors. Total deletions during the study period numbered 1488 of which objections were 26 per cent. Transfers were 77 per cent of deletions excluding objections but only 30 per cent of objections. If added to the known transfers they would increase the total by about 14 per cent. More research is needed to discover whether differences are systematic enough to be allowed for in handling deletion figures alone. Electoral transfers therefore represent an unknown proportion of the total out-migration of electors from any subdivision.

The electoral information most suitable for the purposes of this study is clearly contained within the various categories of deletions and of these 'transfers' in particular. From the fact that the registration rate of electors varies from place to place (see Fig. 3.13) it is to be expected that spatial variation will be evident also in the relative size of that portion of deletions designated as transfers. Therefore a broad analysis is here presented of the distribution of categories of deletions in all subdivisions.

3.9 CATEGORIES OF DELETIONS

The data base for the population movement analysis in this study is that portion of electoral deletions known as transfers. It is able to provide a measure of the flow between each electoral subdivision as an origin and each subdivision as a destination, that is between elements of a matrix. An important part of the following discussion concerns the loss of flow information through

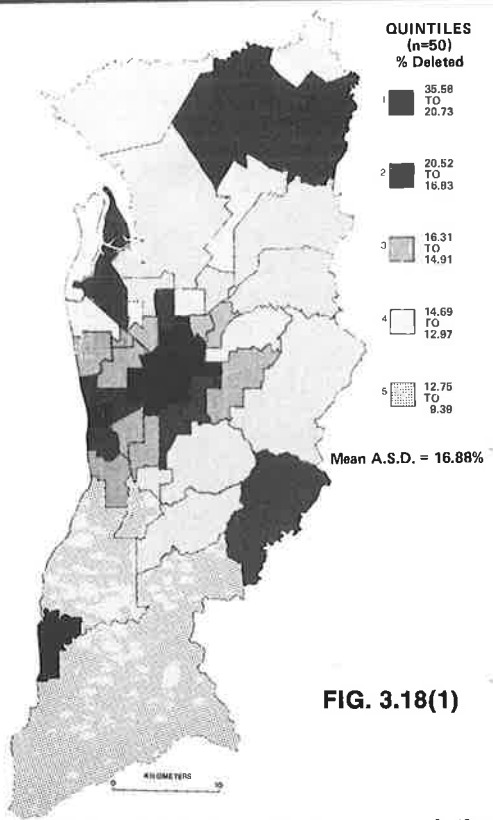

FIG. 3.18(1)

Percentage of mean electoral population deleted 12th March, 1970 to June, 1971.

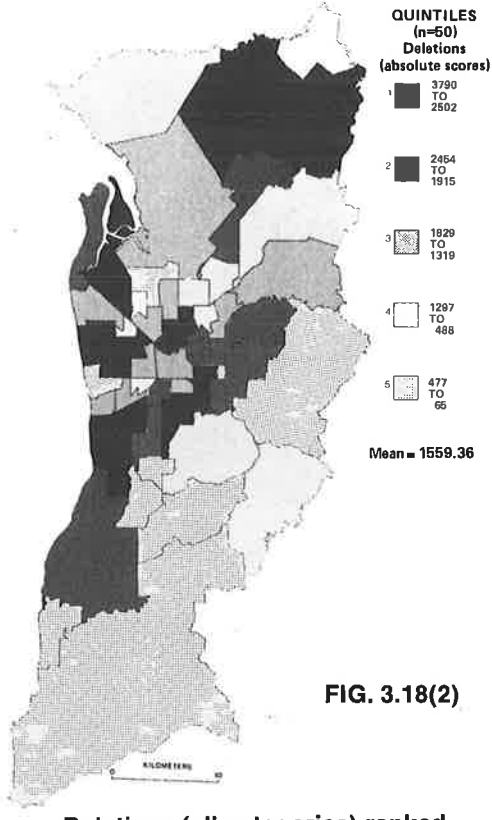

FIG. 3.18(2)

Deletions (all categories) ranked by absolute scores.

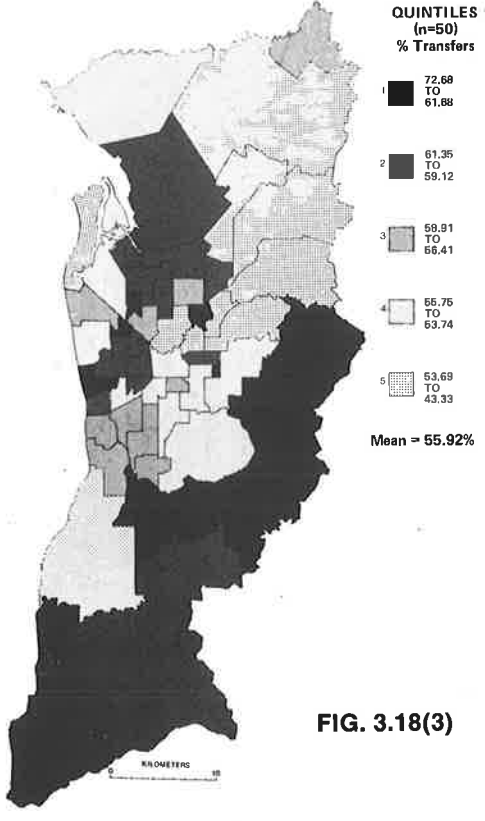

FIG. 3.18(3)

Transfers as a percentage of all deletions.

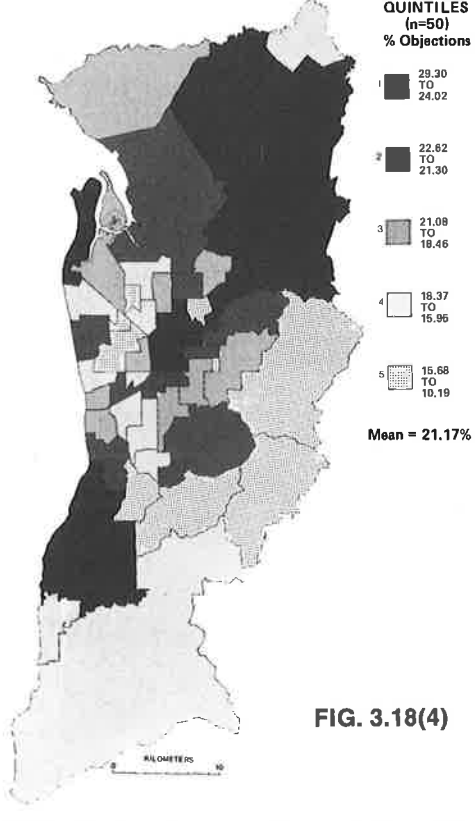

FIG. 3.18(4)

Objections as a percentage of all deletions.

FIG. 3.18: Deletions.

Source: Computations based on data supplied by State Electoral Dept., Adelaide.

that varying portion of electors who are deleted by "objection" because of lack of more precise information. Relative to this, the other categories of deletions are of minor importance.

3.9.1 Distribution of all deletions

An inspection of the map (Figure 3.18/1) of the percentage of the mean electoral population deleted shows a strong concentric zonation centred on the C.B.D. resembling that in Figure 3.9 of net change. The pattern is one to be expected from the earlier discussions on net migration, where it was shown that the newer suburbs experiencing growth, have a surplus of inward movement and, so it may be deduced, relatively fewer outward moves and consequently fewer electoral deletions. The opposite situation applies in the older core areas. Therefore intuitively it seems that the distribution of deletions logically fits information already presented. The map (Figure 3.18/2) shows relative levels of influence on the total city pattern of deletions by ranking of absolute numbers of deletions in individual subdivisions. In each quintile subdivisions are widely scattered with some contiguous grouping so that there is a tendency for each class to cover a wide, even diverse, cross-section of areas. Not surprisingly the areas with largest numbers of deletions are middle suburbs (except Elizabeth).

3.9.2 Summary of all categories of deletions

The relative sizes of the five categories of deletions are summarized for the whole Adelaide Statistical Division in the accompanying Table 3.8.

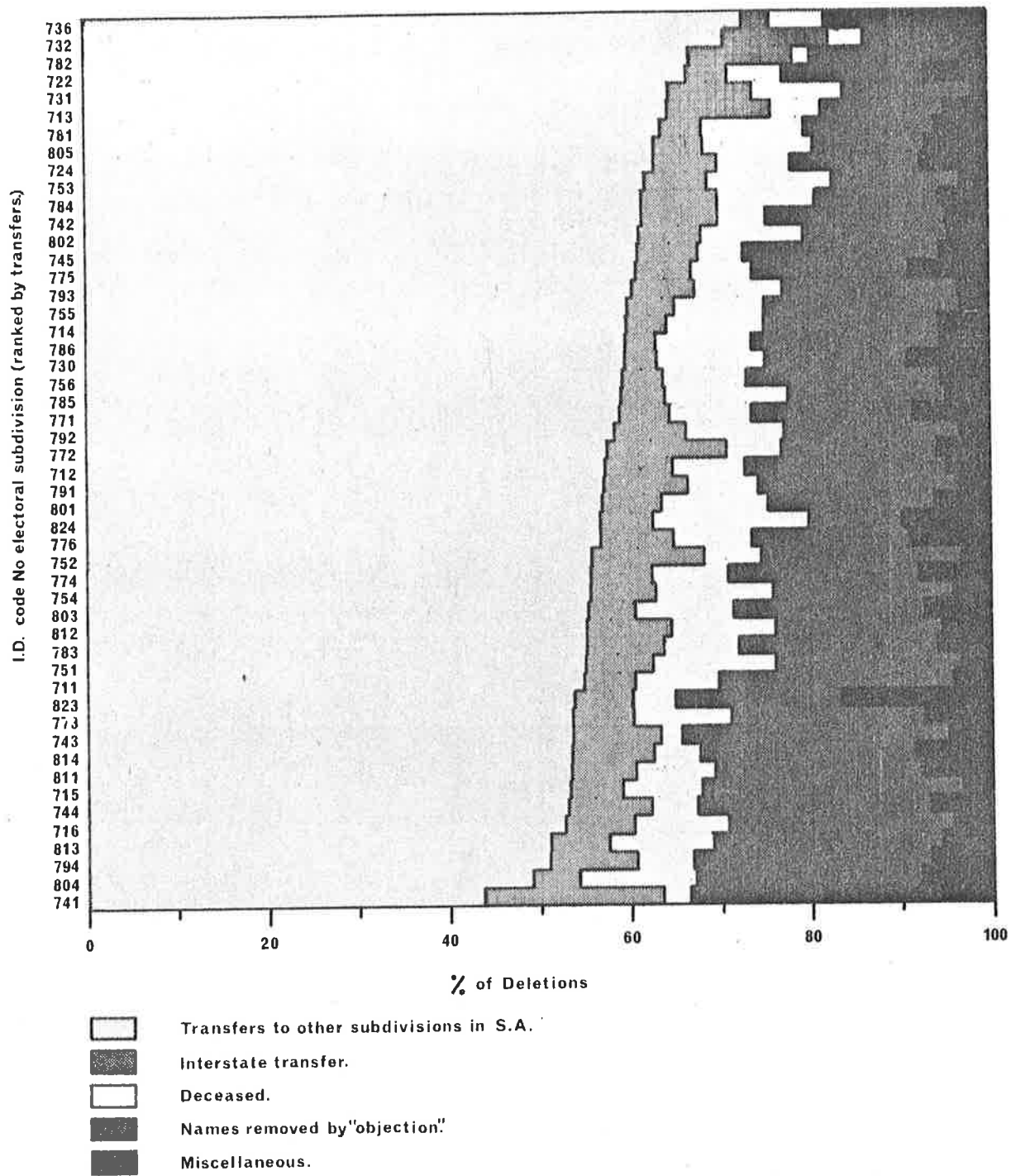

FIG. 3.19. Each subdivision, percentages of categories of deletions from electoral rolls March 16, 1970 to June 11 1971.

Table 3.8

Summary of all Electoral Deletions, Adelaide Statistical Division
from 16/3/70 to 11/6/71

	Categories of deletions					Total deletions
	T transfers	I interstate	D deceased	O objections	M miscellaneous	
Number	43,602	5,986	7,298	16,509	4,573	77,968
percentage deletions	55.92	7.68	9.36	21.17	5.87	100%
Mean per S.D. in A.S.D.	872.04	119.72	145.96	330.18	91.46	1559.36

Source: Data gathered from State Electoral Department.

The table above makes clear that over the whole study area as much as perhaps one-third of transfers (21.17 per cent of all deletions) may be "lost" from that category and consequently to actual flow data to be utilized later. Such a sizeable loss must be examined with the aim of describing its relationships, distributions and relative importance especially in comparison with transfers. That this loss is likely to differ in relative importance from one location to another across the study area is suggested in the set of summary bar graphs (Figure 3.19) showing all subdivisions in rank order of relative proportion of transfers. A comparison of the percentages of transfers and objections raises the possibility of an inverse relationship. The impression is further enhanced by the mapped distributions (Figures 3.18/3 and 3.18/4) where it is apparent that areas with high percentages in one category have low percentages in the other. The Pearson Correlation

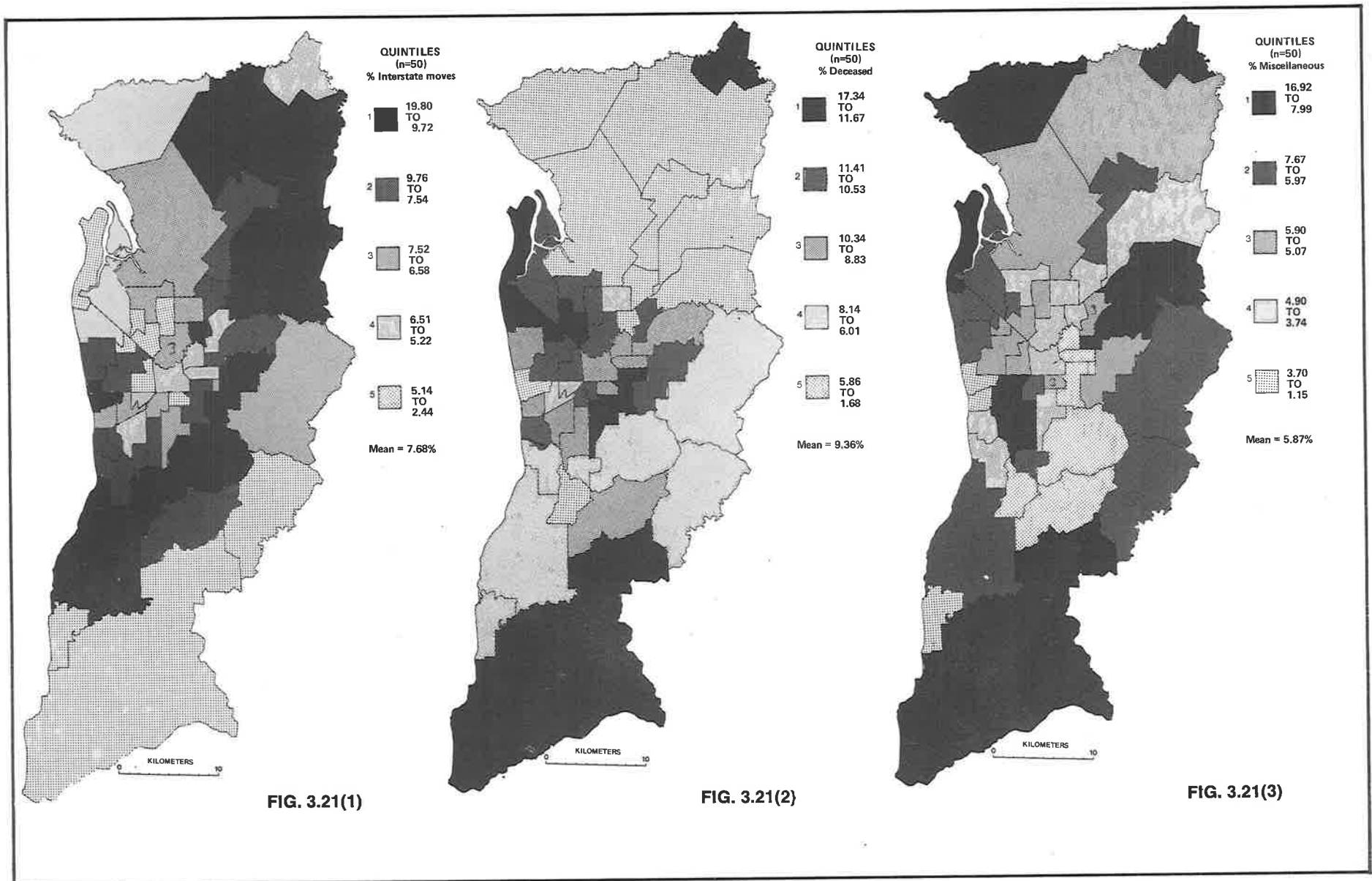

FIG. 3.21: Maps showing (1) Interstate moves as percentage of all deletions. (2) Deceased as percentage of all deletions. (3) Miscellaneous as percentage of all deletions. Source: Computations based on data supplied by State Electoral Dept., Adelaide.

Coefficient of -0.75 confirms that this is a highly significant relationship (at better than 0.01 , df 48). In contrast a comparison of the absolute numbers of transfers and objections reveals a high positive correlation coefficient of 0.92 . The relationship between transfers and objections may be summarized as follows.

- (a) Absolute numbers in the two categories vary in close positive sympathy with one another so that areas with large numbers of transfers also have large numbers of objections.
- (b) The larger the relative proportion of deletions which are transfers from an area the smaller the proportion of objections.

3.9.3 Categories of deletions

The general distribution of all categories of deletions among subdivisions is portrayed in Figure 3.19 and has already been discussed in part. In the accompanying Figure 3.20 a series of five graphs shows separately for each category of deletion the relative percentage ranking of all subdivisions within the general distribution shown by superimposed column graphs. The spread within the respective categories of deletions is approximately normal.

To complete the inventory of deletions Figure 3.21 maps the distribution of the three remaining categories: interstate (transfers), deceased and miscellaneous.

At this point it is appropriate to consider seeking explanations for the spatial variation in categories of deletions. The present need centres, however, on the relationship between transfers

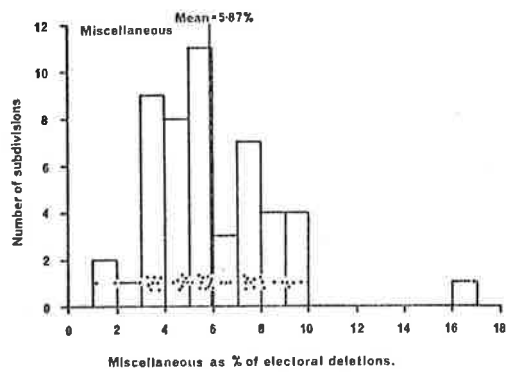
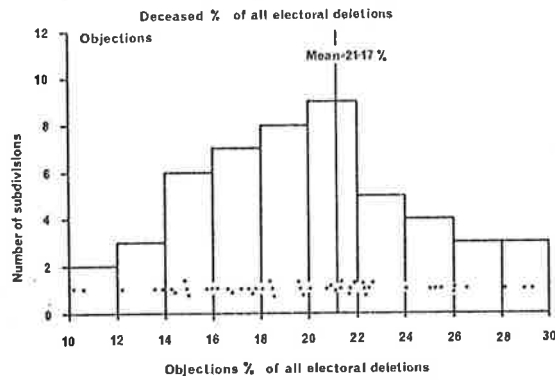
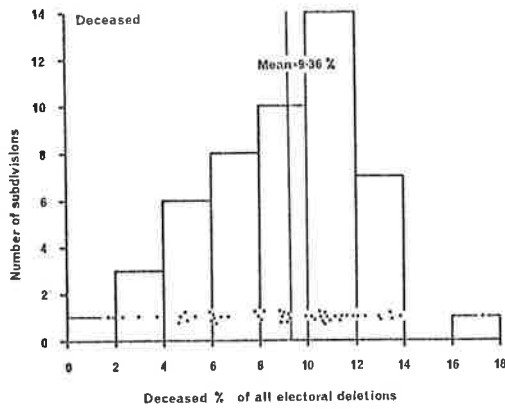
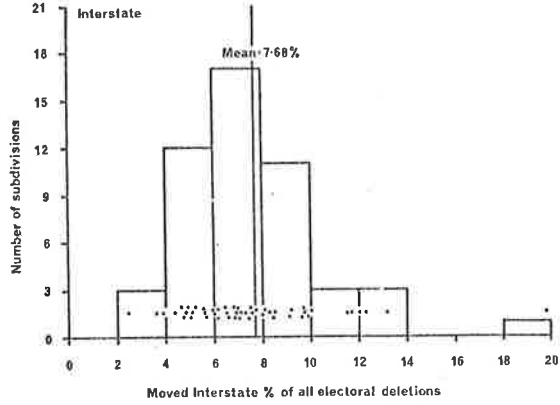
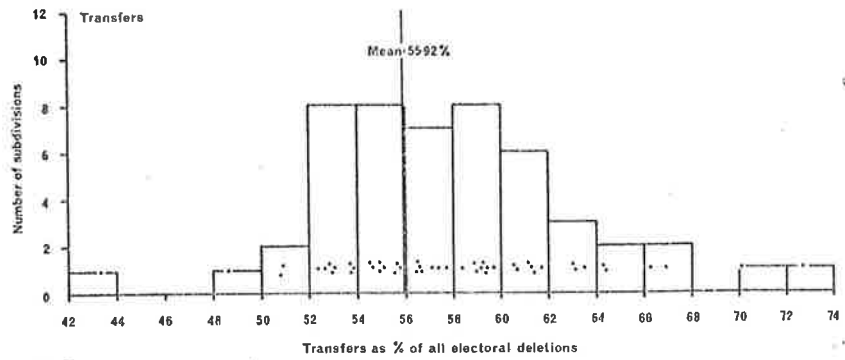

FIG. 3.20. Graphs showing for each subdivision and for each category of deletion the percentage of all deletions which are transfers, interstate, deceased, objections or miscellaneous.

and objections where strong correlations have been identified already. Some of the differences probably derive from local operations by electoral field staff as discussed earlier (section 3.8.1). A search for more detailed explanation would need to include comparison of each category of deletion with a wide range of population variables. Although identification of significant relationships might be of assistance to future users of electoral rolls because of better understanding of the record, it is not justified in the present context.

Correlations between categories of deletions are summarized in the accompanying Table 3.9

TABLE 3-9

Summary of Pearson's Correlation Coefficients between Categories of Deletions (Absolute Scores)

ALL DELETIONS (100%)				
$r = 0.99$		$r = 0.96$		
Transfers (55.9%)	Int. (7.7%)	Decd (9.4%)	Objections (21.2%)	Misc. (5.9%)
$r = 0.76$	→			
$r = 0.91$	→	→		
$r = 0.92$	→		→	
$r = 0.84$	→			→

The outstanding feature of the set of relationships represented is the high predictive ability of the transfers category. The conclusion to be drawn is that although objections represent an

undeniable loss of precision from the record of transfers, changes in the absolute numbers of both, occur in clearly predictable manner. This is taken as an indication that the study of movement at the aggregated level of the Adelaide Statistical Division will not suffer severely through the loss of information represented by "objections". However, variation at the level of the individual subdivision is a different matter, because the relative importance of objections is itself spatially variable.

3.10 SUMMARY

Earlier discussion showed the need for data which the census could not provide on rates of movement, flows and inter-area linkages. It has been demonstrated that a strong similarity exists between net changes within electoral subdivisions whether the census figures or electoral roll figures are used and that the observable differences are explicable in terms of data already available.

The following diagram (Figure 3.22) is intended to summarize the results of the sequence of arguments presented in this chapter. The major object has been to demonstrate that the shift, forced by availability of data, from examination of the entire population to the residential movements of only a portion of that population has been both logical and statistically valid.

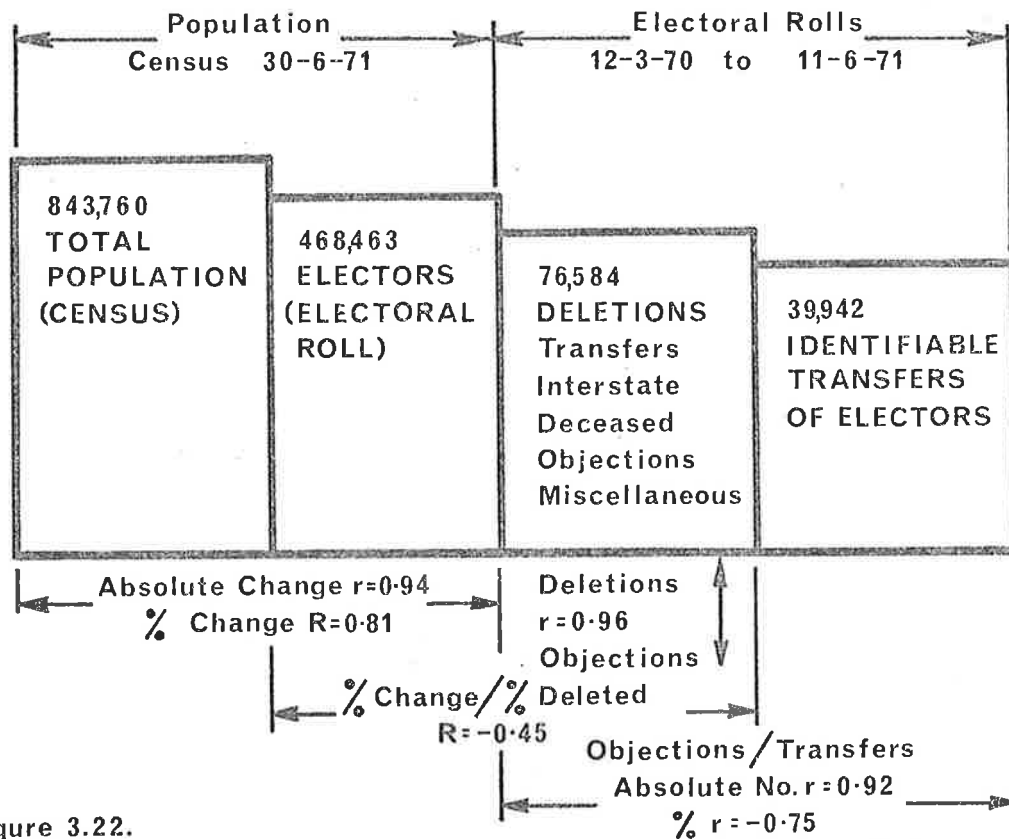

Figure 3.22.
Summary of population groups discussed and correlations between them.

The possibility was rejected of treating the electoral roll as a sample of known proportion of the total population. It was argued that the complex activities necessary to achieve this were not justified by the prospective gains in ability to generalize the results. Whatever movement patterns do emerge from this study of data from electoral rolls may be taken to apply only to electors. Generalization to the wider population is uncertain and

risky. No claim can be made that what is reported applies directly to the full population - tempting and convenient (and sometimes correct) though that may be. Residential movement of registered electors is the subject of study and any generalizations developed can be applied properly only to that section of the population until tested more widely.

REFERENCES

- ADAMS, R.B. (1969) 'U.S. Metropolitan Migration: Dimensions and Predictability'. Proceedings, Association of American Geographers, vol. 1, pp. 1-6.
- AITCHISON, D.L.J. (1969) South Australian Year Book, No.4. Commonwealth Bureau of Census and Statistics, S.A. office.
- ALONSO, W. (1964) Location and Land Use, Harvard University Press, Cambridge, Massachusetts.
- BLUMENFELD, H. (1949) 'On the Concentric-Circle Theory of Urban Growth'. Land Economics, vol. 25, pp. 209-212.
- BLUMENFELD, H. (1954) 'The Tidal Wave of Metropolitan Expansion'. Journal of American Institute of Planners, vol. 20, pp. 3-14.
- BROWN, L.A. and HOLMES, J. (1971) 'Intra-urban Migrant Lifelines: A Spatial View'. Demography, vol. 8, no. 1, pp. 103-122.
- BURGESS, E.W. (1925) 'The Growth of the City'. In The City, edited by R.E. Park, E.W. Burgess and R.D. McKenzie. University of Chicago Press, Chicago, pp. 47-62.
- BURNLEY, I.H. (1974) (ed.) Urbanization in Australia, The Post War Experience. Cambridge University Press, Cambridge.
- Commonwealth Electoral Act, 1918-1966. 1 July, 1971.
- CHUGG, D.R. (1971) 'Population Change and Intra-urban Migration in Adelaide, 1961-70'. Unpublished thesis, Geography Dept, University of Adelaide.
- CLARK, W.A.V. (1970) 'Measurement and Explanation in Intra-urban Residential Mobility'. Tijdschrift Voor Econ. En. Soc. Geog., vol. lxi, no. 1, pp. 49-57.
- DONALDSON, B. and JOHNSTON, R.J. (1973) 'Intra-urban Sectoral Mental Maps: Further Evidence from an Extended Methodology'. Geographical Analysis, vol. 5, no. 1, pp. 45-54.
- DOUGLASS, N.B. (1971) 'Development of Computer Maintained Electoral Rolls in South Australia'. Unpublished paper prepared for conference of electoral department officers, Melbourne.

- Electoral Act, 1929-1969 (State of South Australia), Reprinted
3 August, 1970.
- HÄGERSTRAND, T. (1957) 'Migration and Area'. Lund Studies in
Geography, Series B, no. 13, pp. 27-158.
- HARRIS, C.D. and ULLMAN, E.L. (1945) 'The Nature of Cities'
Reprinted in Readings in Urban Geography. Edited
by H.M. Mayer and C.F. Kohn, University of Chicago,
1959, pp. 277-286.
- HERBERT, D. (1972) Urban Geography. A Social Perspective. David
and Charles, Newton Abbot, Devon.
- HUGO, G.J. (1971a) 'Internal Migration in South Australia 1961-1966'.
Unpublished thesis, Dept. of Geography, Flinders
University, S.A.
- HUGO, G.J. (1974) 'Internal Migration and Urbanization in South
Australia'. In Urbanization in Australia. Edited
by I.H. Burnley, Cambridge University Press, pp. 81-98.
- MOORE, E.G. (1966a) 'Models of Migration and the Intra-urban Case'.
Australian and New Zealand Journal of Sociology, vol. 2,
no. 1, pp. 16-37.
- MOORE, E.G. (1966b) 'Residential Mobility in an Urban Context: A
Systems Approach'. Unpublished Ph.D. thesis, University
of Queensland.
- MOORE, E.G. (1969a) 'The Structure of Intra-urban Movement Rates:
An Ecological Model'. Urban Studies, vol. 6, no. 1,
pp. 17-33.
- MOORE E.G. (1969b) 'The Nature of Intra-urban Migration and Some
Relevant Research Strategies'. Proceedings of the
Association of American Geographers, pp. 113-116.
- MOORE, E.G. (1970) 'Intra-urban Residential Mobility and Urban Spatial
Structure'. In Population and Migration in an Urban
Context: A Spatial Perspective (Paper no. 1) Meetings
of the Population Association of America.
- MOORE, E.G. (1972) 'Residential Mobility in the City'. Association
of American Geographers, Commission on College
Geography, Resource Paper no. 13.
- MORRILL, R.L. (1965a) 'Migration and the Spread and Growth of Urban
Settlement'. Lund Studies in Geography, Series B. No. 26.

- MORRILL, R.L. (1970) The Spatial Organization of Society.
Duxbury Press, Belmont, California.
- OLSSON, G. (1965a) 'Distance and Human Interaction A Migration Study'. Geografiska Annaler (Series B), vol. 47 B, pp. 3-43.
- SIMMONS, J.W. (1968) 'Changing Residence in the City - A Review of Intra-urban Mobility'. Geographical Review, Vol. 58, no. 4, pp. 622-651.
- STIMSON, R.J. (1971) 'Social Differentiation in Residential Areas in Adelaide'. 43rd Anzaas Congress, Section 21, Brisbane.
- STIMSON, R.J. (1972) 'Perceived Status and Residential Desirability of Adelaide Suburbs'. 44th Anzaas Congress, Section 21, Sydney.
- STIMSON, R.J. and CLELAND, E.A. (1975) A Socio-Economic Atlas of Adelaide An analysis of the 1971 Census. School of Social Sciences, The Flinders University of S.A, and the Department for Community Welfare, South Australia.
- WARD, B.J. (1975) 'The Use of Electoral Rolls in the Study of Internal Migration'. Australian Geographical Studies, vol. 13, no. 1, 94-107.
- WHITELAW, J.S. and GREGSON, J.S. (1972) 'Search Procedures in the Intra-urban Migration Process'. Monash Publications in Geography, No. 2
- WHITELAW, J.S. and ROBINSON, S. (1972) 'A Test for Directional Bias in Intra-urban Migration'. New Zealand Geographer, vol. 28, no. 2,
- WOLF, L.G. (1969) 'The Metropolitan Tidal Wave in Ohio, 1900-2000'. Economic Geography, vol. 45, no. 2, pp. 133-145.
- WOLPERT, J. (1965) 'Behavioural Aspects of the Decision to Migrate'. Papers of the Regional Science Association, vol. 15, pp. 159-169.

CHAPTER 4

DIRECT EVIDENCE OF POPULATION MOVEMENT

...one needs to understand not only the conditions which stimulate movement, but also the distribution of such moves in relation to the spatial aspects of the structure itself.

MOORE (1966a, p.16)

OUTLINE

The formulae described by Moore (1969a and 1971) and applied by him in Brisbane is utilized to calculate indices for elector change in each subdivision in terms of annual net migration and annual population turnover. A ranking classification and mapping of the indices provides a basis for development and discussion in later chapters. The 1971 census is the source of information on which a mover-stayer ranking of subdivisions is made. The electoral rolls reveal that not all the possible links between subdivisions are utilized by transferring electors so that there are active and inactive links.

To enable distances and directions between electoral subdivisions to be applied to the migratory flows, which are to be discussed in later chapters, centroids are allotted to each subdivision.

CHAPTER 4. DIRECT EVIDENCE OF POPULATION MOVEMENT

CONTENTS		Page
4.1	INTRODUCTION	126
4.2	MOVER-STAYER ANALYSIS	127
4.3	INDICES OF MOVEMENT	130
4.3.1	Net Migration Index	130
4.3.2	Population Turnover Index	133
4.3.3	Comparison of Movement Indices with Percentage Eligibles on the Roll	138
4.4	MOVERS/OUTMIGRANTS	141
4.4.1	Outline	141
4.4.2	Relative Importance of Donor Areas	141
4.4.3	Comparison of Outmigration to Areas Within and Without Adelaide Statistical Division	142
4.5	ACTIVE LINKS	145
4.6	CENTROIDS	148
4.6.1	The Need for Points in a Network	148
4.6.2	Determination of Centroids	149
4.7	SUMMARY	152
	REFERENCES	154

CHAPTER 4. DIRECT EVIDENCE OF POPULATION MOVEMENT

LIST OF FIGURES

Figure		Page
4.1	Mover-stayer analysis. Comparison of data derived from census and electoral rolls by electoral subdivision: (1) absolute numbers of stayers, (2) percentage mean annual stayers, (3) absolute numbers of movers, (4) percentage mean annual movers.	under p. 122
4.2	Comparison of mean annual percentage of stayers derived from (1) electoral data, (2) census data, and (3) ranking deviations.	facing p.129
4.3	(Index NM) Percentage annual net migration of electors, 1970-71.	facing p.132
4.4	(Index PT) Percentage annual population turnover of electors, 1970-71.	facing p.134
4.5	Comparison of percentage annual rates of net migration and population turnover for Adelaide Electoral Subdivisions.	under p.134
4.6	Cross classification of electoral subdivisions on annual rates of net migration and population turnover.	under p.135
4.7	Topological map of annual population turnover 1970-71, Electoral Subdivisions.	facing p.138
4.8	Relationship between population indices and percentage of eligibles (unadjusted and adjusted) on electoral rolls.	under p.138
4.9	Total electoral transfers from subdivisions 1970-71 (1) Rank order (2) Size distribution	facing p.141

- 4.10 Out-transfers of electors from electoral subdivisions, Adelaide Statistical Division 1970-71: facing p.142
- (1) Percentage of electoral transfers to destinations within Adelaide Statistical Division.
 - (2) Subdivisions ranked by total outflow to Adelaide Statistical Division (CITY to CITY).
 - (3) Subdivisions ranked by total outflow to areas outside Adelaide Statistical Division (CITY to RURAL).
- 4.11 Cumulative frequencies of active links and individual moves, facing p.146
- (1) Cumulative frequency of active links utilized by origin subdivision,
 - (2) Comparison of cumulative percentages by volume of connecting flow for active links and individual moves.
- 4.12 Electoral subdivisions ranked as origins by number of active links (destinations) used by transfers. under p.146
- 4.13 Location of calculated population centroids in Electoral Subdivisions, 1971. facing p.151

CHAPTER 4. DIRECT EVIDENCE OF POPULATION MOVEMENT

LIST OF TABLES

Table		Page
4.1	Mover-stayer analysis: Numbers and relative proportions of movers and stayers measured by census and electoral records.	facing p. 128
4.2	Comparison of correlation coefficients of census and electoral derived mover-stayer information.	130
4.3	Data from electoral rolls - additions, deletions, internal changes of address and annual indices of movement of electors.	facing p. 131
4.4	Cross classification of electoral subdivisions by annual rates of net migration and population turnover.	facing p. 135
4.5	Census derived index of mean annual population turnover (Tt) 1966-1971, Adelaide Statistical Division.	137
4.6	Pearson correlation coefficients between (X) indices of net migration and population turnover and (Y) percentage unadjusted and adjusted on the electoral roll, Adelaide Statistical Division.	139

CHAPTER 4. DIRECT EVIDENCE OF POPULATION MOVEMENT

4.1 INTRODUCTION

The purpose of this chapter is to begin examination of the spatial characteristics of the evidence recorded in electoral rolls of residential movement within the population. The distributions of two indices of annual rates of movement and the relative proportions of movers to stayers are discussed. The number of inter-subdivisional links actually used in the network is compared with the maximum possible. This leads to the calculation of the location of a centroid for each cell (subdivision) whereby the geometric characteristics of the network are described as a basis for later analysis of distance and direction of movement.

The evidence of movement discussed in chapter three was of net migration. It is here described as "indirect" evidence because no direct account of movement has been available. The idea of migratory movement was invoked in that context merely to account for those changes in the total population found to be "surplus" to that explained by natural increase. By contrast, information on population movement to be discussed in this chapter, is direct evidence of change of address by electors taken from official electoral records. It was made clear in the previous chapter that the main data source for this analysis was the transfer category of the cumulative deletions list maintained by the (S.A.) State Electoral Department.

4.2 MOVER-STAYER ANALYSIS

A simple but useful general measure of residential movement is a categorization of all residents as either movers or stayers. In a given time span every resident either changes his place of dwelling and is therefore a "mover" or remains and is a "stayer". Although crude when compared with other measures, this simple dichotomy can be applied to data derived from both the census and the electoral roll, making it possible to achieve further assessment of the similarity of the two sources on a single population behaviour parameter.

A question asked in the 1971 census gathered information about all "stayers" but not all "movers". The published figures cover only those enumerated at the 1971 census and are available for the Adelaide Statistical Division for the 1966-71 intercensal in A.B.S. Bulletin 7.4 (p.98). The table provides the number who had remained in the same dwelling and additionally those who had moved either within the Division or into the Division from either intra-state or interstate. Despite the 8.5 per cent from whom inadequate information was available, a reasonable picture can be presented of the pattern of "stayers". However the complementary data-set of "movers" is not so easily described because of the unknown extent of leakage from the system over the five years. Although composite figures for "movers" can be assembled from the published information, the result must be seen as approximate.

TABLE 4.1

Mover-Stayer Analysis: Numbers and Relative Proportions of Movers and Stayers Measured by Census and Electoral Records.

CODE NO.	SUB-DIVISION	CENSUS										ELECTORAL																		
		Pop ⁿ Census 1966		Pop ⁿ Census 1971		M O V E R S					M O V E R S					Pop ⁿ Elec. Rolls 12/7/70		Pop ⁿ Electoral 11/6/71		S T A Y E R S					M O V E R S					
		No.	Rank	Annual %	Rank	No.	Rank	Annual %	Rank	No.	Rank	Annual %	Rank	No.	Rank	Annual %	Rank	No.	Rank	Annual %	Rank	No.	Rank	Annual %	Rank	No.	Rank	Annual %	Rank	
71	ADELAIDE																													
711	Adelaide	10 966	8 869	2 417	41	84.41	50			8 549	18	15.59	1	3 814	3 601	2 351	41	69.50	50			1 289	30	30.44	1					
712	Florey West	17 503	17 216	11 385	19	93.01	4			6 118	27	6.99	47	9 767	9 735	8 479	21	89.44	5			1 157	32	10.56	46					
713	Cilles West	11 486	12 357	7 377	26	92.85	6			4 109	35	7.15	45	6 653	6 838	5 586	31	87.16	14			984	34	12.84	37					
714	Ross Smith	20 487	19 053	12 293	16	92.00	19			8 191	20	8.00	32	11 843	11 670	9 752	20	85.88	22			1 929	18	14.12	29					
715	St. Peters	15 260	14 896	7 596	25	89.69	42			7 864	21	10.21	9	8 076	7 873	6 001	27	79.44	44			1 906	19	20.56	7					
716	Torrens	26 616	26 264	11 556	18	68.91	47			14 760	1	11.09	4	15 884	15 701	11 684	16	78.84	46			3 723	1	21.16	5					
72	ANGAS (Part)																													
722	Fisher East	6 159	6 751	3 455	39	91.22	33			2 704	39	8.78	18	4 125	4 117	3 207	38	82.20	37			782	39	17.80	14					
724	Heysen North (pt)	3 627	3 825	2 169	44	91.96	21			1 453	45	8.04	30	2 433	2 537	1 984	42	85.64	26			265	43	14.76	22					
73	BARKER (Part)																													
730	Alexandra (pt)	4 250	4 315	2 301	42	90.83	36			1 949	44	9.17	15	2 326	2 436	1 908	46	83.64	34			257	46	14.36	25					
731	Fisher South	775	1 226	268	49	94.66	3			207	49	5.34	48	597	688	509	50	88.20	6			86	49	11.80	45					
732	Flagstaff (pt)	1 021	2 794	575	48	91.26	31			446	48	8.74	20	975	1 326	861	47	90.64	3			109	48	9.36	48					
736	Moana	538	1 931	534	50	99.85	1			4	50	0.15	50	844	1 004	631	48	79.80	43			198	47	20.20	8					
74	BONYTROU																													
741	Elizabeth	28 109	33 994	13 480	14	89.59	44			14 628	2	10.41	7	14 752	15 429	11 645	17	83.16	35			2 690	5	16.84	16					
742	Horey East	10 286	18 373	5 975	32	91.62	23			4 311	34	8.38	28	6 774	9 118	5 933	28	90.32	4			746	37	9.68	47					
743	Modbury North	4 682	11 544	2 633	40	91.25	32			2 049	43	8.75	19	4 226	5 456	3 582	36	87.80	11			571	40	12.20	40					
744	Playford	28 785	35 767	15 886	8	91.04	35			12 899	4	8.96	16	15 152	16 933	12 571	11	86.48	18			1 127	16	13.52	31					
745	Salisbury	22 386	29 591	13 881	12	92.40	13			8 505	19	7.60	38	13 841	14 361	11 786	14	85.12	7			1 780	22	11.88	44					
75	BOOTHBY																													
751	Brang	24 288	24 706	11 905	17	89.80	41			12 383	5	10.20	10	15 337	15 369	11 964	13	82.40	36			2 970	3	17.60	15					
752	Fisher North	12 374	15 733	7 111	29	91.49	27			5 263	31	8.51	24	8 572	9 118	7 020	24	85.52	27			1 280	31	14.48	24					
753	Letchbrook	1 812	1 948	924	46	90.20	40			868	46	9.80	11	1 400	1 442	1 121	46	84.08	32			269	45	15.92	18					
754	Mitcham	23 415	23 697	13 222	15	91.29	30			10 193	12	8.71	21	15 840	15 840	12 835	8	84.84	31			2 642	6	15.16	19					
755	Horwood	15 423	14 464	6 714	30	88.71	48			8 709	17	11.29	3	8 095	8 217	5 737	29	76.72	49			2 056	17	23.28	2					
756	Unley	10 875	11 110	5 150	33	89.47	45			5 725	30	10.53	6	6 328	6 463	4 521	34	77.36	48			1 620	24	22.84	3					
77	HANKER																													
771	Ascot Park	26 684	25 329	16 417	6	92.59	3			9 667	14	7.41	4	15 747	15 670	11 003	7	86.06	21			2 490	9	13.92	31					
772	Fisher West	4 298	4 969	2 247	43	90.46	3			2 051	42	9.54	13	2 258	2 399	1 909	43	87.64	12			329	44	12.36	39					
773	Goodwood	15 094	14 856	7 272	27	89.64	43			7 022	22	10.36	8	9 490	9 168	7 016	25	79.16	45			2 296	14	20.84	6					
774	Hanson East	11 101	12 183	6 650	31	91.59	20			4 452	33	8.02	31	7 382	7 577	5 729	30	82.08	39			1 561	25	17.92	12					
775	Marleston	7 207	7 473	4 014	37	91.34	34			3 193	36	8.66	17	4 431	4 425	3 242	37	78.56	47			1 144	33	21.44	4					
776	Hitchell	26 256	27 484	16 960	3	92.92	5			9 296	15	7.08	46	15 838	15 944	13 234	5	86.84	15			2 317	13	13.16	36					
78	HINDMARSH																													
781	Beverley	6 157	6 181	3 768	38	92.24	16			2 389	41	7.76	35	3 358	3 654	2 852	40	87.96	9			563	38	12.04	42					
782	Hanson North	4 355	5 880	1 565	45	87.65	49			2 690	46	12.35	2	2 251	2 424	1 784	45	82.12	38			464	39	17.83	13					
783	Honley Beach	27 630	30 394	16 904	4	92.23	17			10 746	9	7.77	34	16 380	17 053	13 330	3	85.12	29			2 509	8	14.89	21					
784	Peake	26 546	27 737	16 188	7	92.20	18			10 358	17	7.80	33	15 483	15 692	12 730	9	85.80	25			2 435	11	14.20	26					
785	Spence South	18 324	17 190	10 562	21	91.53	25			7 762	24	8.47	26	9 533	9 339	7 875	22	86.08	20			1 491	27	13.92	31					
786	Thebarton	16 393	15 872	8 663	24	90.57	37			7 730	25	9.43	14	8 556	8 459	6 519	26	80.96	42			1 767	23	19.04	9					
79	KINGSTON																													
791	Erington	28 837	29 877	18 049	2	92.52	10			10 788	8	7.48	41	16 267	16 615	13 300	4	85.40	28			2 347	7	14.60	23					
792	Glennelg	26 252	26 218	15 014	10	91.44	29			11 236	7	8.56	22	16 375	16 570	13 078	6	83.92	33			2 853	4	16.08	17					
793	Hanson South	10 930	11 746	5 046	34	89.27	46			5 862	29	10.73	5	7 141	7 550	5 465	32	81.24	41			1 465	28	18.76	20					
794	Hawson	16 352	32 203	10 544	22	91.49	28			7 808	25	8.51	24	14 257	16 613	11 764	15	85.94	24			1 879	20	14.16	20					
80	FORT ADELAIDE																													
801	Albarr Park	23 157	21 702	14 421	11	92.45	12			8 736	16	7.55	39	12 567	12 420	10 587	18	87.40	13			1 788	21	17.60	36					
802	Angle Park	8 015	7 649	5 044	35	92.59	9			2 971	38	7.41	43	3 547	3 653	3 145	39	90.96	2			391	42	9.04	49					

The electoral rolls (and their maintenance procedures) were described earlier in this study (see section 3.7 and 3.8). It should be apparent that the continuous updating and use of cumulative lists of additions, deletions and amendments produce what are in effect lists of movers and stayers. In the case of the electoral roll, it is the mover category which is most easily studied but the record would seem to be of about equal reliability for both categories. The following comparative discussion begins with stayers because this is the aspect directly covered by the census. A comparison is made between the measure of stayers obtained from both electoral and census sources and afterwards a brief examination is made of the distribution of movers. Table 4.1 is a composite listing of all the appropriate data from the two sources.

The graph in Figure 4.1/1 compares the absolute number of stayers for each electoral subdivision as obtained from both the census and from electoral rolls. The two sets of figures closely follow the same trend in measuring the same behavioural characteristic in the same population as is shown by the highly significant Pearson's Correlation Coefficient of 0.979 (df 48). The mean annual percentage of stayers derived for each subdivision from the same sources is shown graphically in Figure 4.1/2. The correlation coefficients between percentages, though still significant at better than 0,005 (df 48), is much lower at $r = 0,672$. This indicates a greater variability in relative proportions of stayers expressed as annual rates. The distributions of the latter two

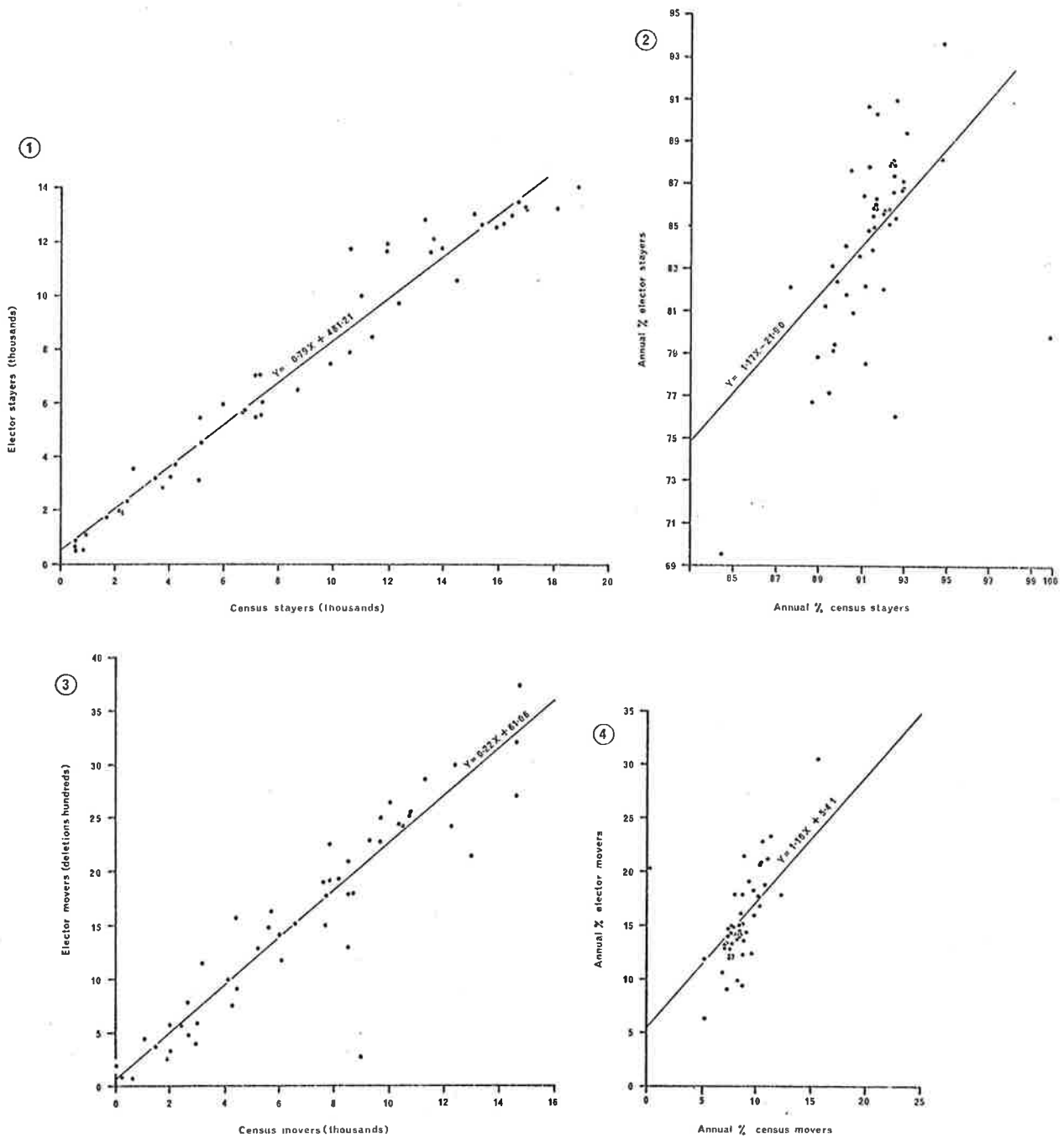

FIG. 4.1. Mover-stayer analysis. Comparison of data derived from census and electoral rolls by electoral subdivisions: (1) absolute numbers of stayers (2) percentage mean annual stayers (3) absolute number of movers (4) percentage mean annual movers.

Notes: Census data, A.B.S. censuses June 30 1966 and June 30 1971.
 Electoral data from state Electoral Dept. Adelaide March 12, 1970 to June 11 1971.

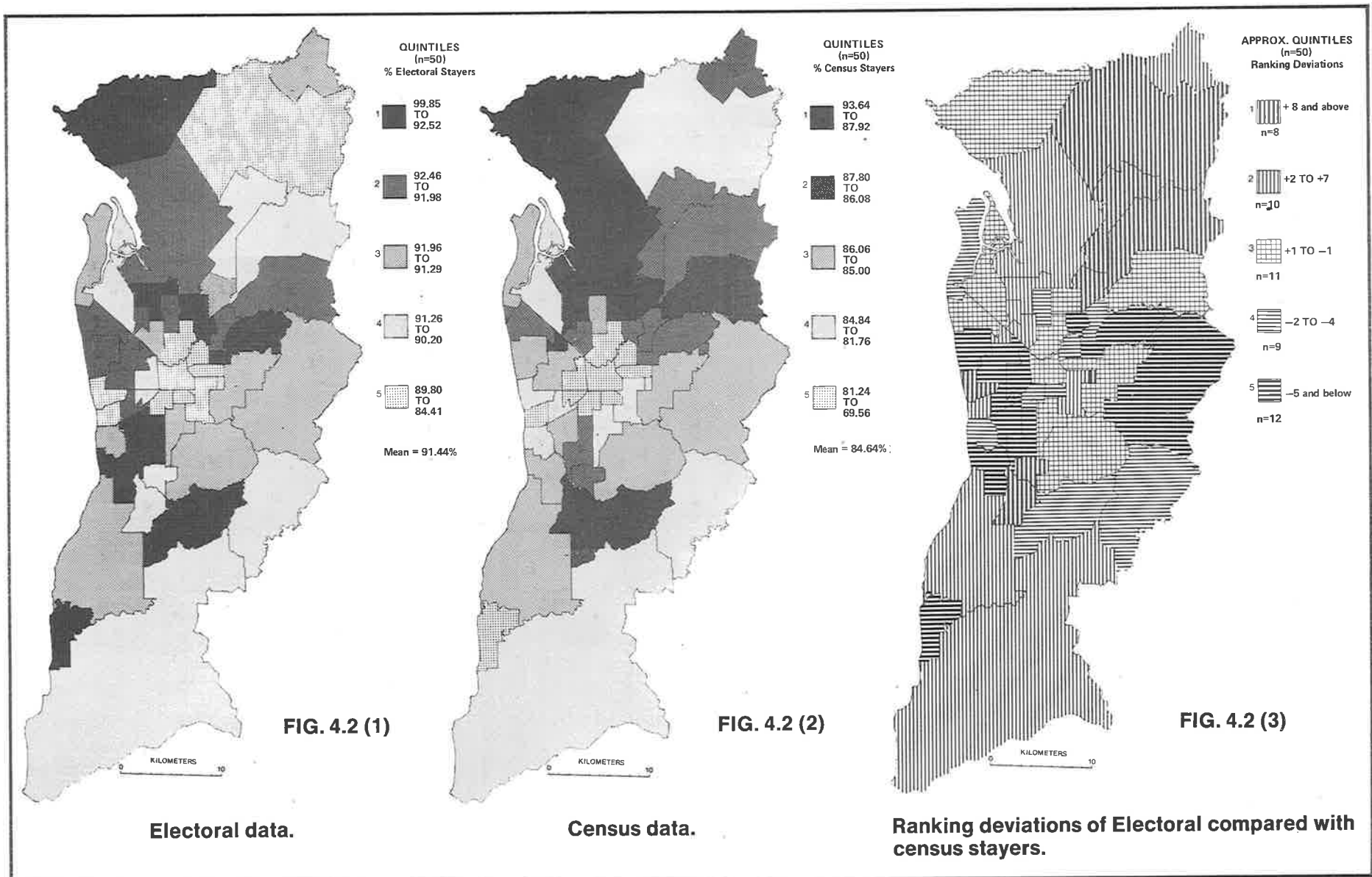

FIG. 4.2: Comparison of mean annual percentage of stayers derived from (1) electoral data (2) census data and (3) ranking deviations. Sources: Basic data from Australian Bureau of Statistics and State Electoral Dept., Adelaide.

measures are mapped in Figure 4.2. The most obvious areas of agreement have values in one or other of the two extremes of the scale. The inner areas have low stayer scores while two separate areas, one to the north and the other to the south, both have high scores. The map (Figure 4.2/3) shows the ranking deviations of the electoral measure as compared with the census. Areas of greatest positive deviation are expectedly those where considerable growth has occurred recently. Because the electoral measure was taken from a short, more recent, time span it was a more sensitive indicator of such change than the data from the census. The negative deviations (21 cases) are less readily explained as they include a wider range of growth types. Comparison with the earlier analysis shown in Figure 3.10 reveals that only about a third are cases which the electoral record had been shown to under-estimate in population change. About one half of all the negative deviations are however areas with relatively high proportions of adult aliens (see Figure 3.11/2) a section of the population not covered by the electoral record. Three seaside areas - Semaphore, Glenelg and especially Moana - were ranked lower on stayers by the electoral record than by the census. The last two, in particular, are areas of high population turnover with holiday makers and transients in temporary accommodation, people who would be lost to the census, or at least would be seriously under-estimated, so that the stayer element would be relatively over-estimated.

The data set complementary to stayers is movers. But because there is no complete record of the total population occupying the study area between censuses it is not possible to obtain a reliable

measure of all movers, It has been pointed out already that even the electoral record of movers is not complete. Nevertheless an attempt was made to assemble from both sources an estimate of movers for all subdivisions. The results are graphed in Figure 4.1/3 and Figure 4.1/4 and reveal that mover scores, both absolute and relative, are only slightly less closely related than were those for stayers. The accompanying Table 4.2 summarizes the relationships.

Table 4.2

Comparison of Correlation coefficients between census (X) and electoral (Y) derived mover-stayer information for electoral subdivision, Adelaide Statistical Division.

	Movers	Stayers
percentage	$r = 0,570$	$r = 0,572$
absolute	$r = 0,959$	$r = 0,979$

All relationships are highly significant at better than 0,005 (df 48).

4.3 INDICES OF MOVEMENT

4.3.1 Net Migration Index

Rates of net migration based on census data in the Adelaide Statistical Division have been described already for 1961 to 1966 (Figure 3.1/3) and 1966 to 1971 (Figure 3.4/3). However these were for L.G.A.s. The same kind of calculation cannot be achieved for electoral subdivisions because birth and death rates from which rates of natural increase are derived are not available for these spatial units. Fortunately Moore (1971) has demonstrated the effectiveness of an index of net migration which conveniently avoids

TABLE 4.3

Data from Electoral Rolls - Additions, Deletions,
Internal Changes of Address and Annual
Indices of Movement of Electors.

CODE SUB-DIVISION NO.	1 Et	2 It	3 Mt	4 Pt	5 Annual % Turnover (Tt)	6 Rank	7 Annual % Net Migration (Nt)	8 Rank
71 = ADELAIDE								
711 Adelaide	1 289	1 073	163	3 707	26.67	1	- 4.66	50
712 Florey West	1 157	1 280	56	9 751	* 9.95	46	+ 1.01	31
713 Gilles West	984	1 163	86	6 745	* 12.69	36	+ 2.12	22
714 Ross Smita	1 929	1 754	163	11 756	13.04	34	- 1.19	46
715 St. Peters	1 906	1 700	170	7 974	18.76	6	- 2.37	48
716 Torrens	3 723	3 539	477	15 792	20.34	5	- 0.93	42
72 = AWGAS (Part)								
722 Fisher East	782	774	136	4 121	17.67	12	- 0.002	36
724 Heysen North (pt)	365	489	74	2 485	* 14.13	24	+ 3.99	14
(whole)	1 007	1 260	144	6 670	* 13.80		+ 3.03	
73 = BARKER (Part)								
730 Alexandra (pt)	257	487	101	2 381	* 12.03	38	+ 7.73	9
(whole)	1 047	1 544	386	10 284	* 11.15		+ 3.87	
731 Fisher South	86	176	2	642	* 10.97	44	+ 11.21	6
732 Flagstaff Hill	109	456	7	1 150	* 8.07	50	+ 24.14	1
736 Moana	198	359	15	924	* 18.44	9	+ 13.94	4
74 = BONYTHON								
741 Elizabeth	2 690	3 392	419	15 105	* 16.47	16	+ 3.72	15
742 Florey East	746	2 183	75	7 492	* 8.77	49	+ 15.34	3
743 Nodbury North	571	1 799	74	4 841	* 10.66	45	+ 20.29	2
744 Playford	2 127	3 926	435	16 032	* 12.78	35	+ 8.98	8
745 Salisbury	1 780	2 294	278	14 101	* 11.68	41	+ 2.92	17
75 = BOOTHBY								
751 Bragg	2 970	2 997	406	15 353	* 17.59	13	+ 0.01	35
752 Fisher North	1 280	1 825	272	8 845	* 14.04	26	+ 4.93	12
753 Leabrook	269	311	10	1 421	* 15.71	18	+ 2.36	18
754 Mitcham	2 642	2 640	364	15 840	15.17	19	- 0.01	37
755 Norwood	2 086	2 197	277	8 156	* 23.18	2	+ 1.09	29
756 Unley	1 620	1 745	192	6 395	* 22.67	3	+ 1.56	25
77 = HAWKER								
771 Ascot Park	2 499	2 414	254	15 708	13.59	28	- 0.39	40
772 Fisher West	329	470	20	2 328	* 11.99	39	+ 4.84	13
773 Goodwood	2 296	1 971	180	9 329	18.45	8	- 2.79	49
774 Hanson East	1 561	1 706	117	7 479	* 17.95	11	+ 1.55	26
775 Marleston	1 444	1 136	46	4 428	21.35	4	- 0.14	38
776 Mitchell	2 337	2 439	269	15 891	* 13.12	31	+ 0.51	34
78 = HINDMARSH								
781 Beverley	563	658	43	3 506	* 13.83	27	+ 2.17	21
782 Hanson North	464	637	39	2 337	* 17.22	15	+ 5.92	10
783 Henley Beach	2 509	3 179	542	16 716	* 14.60	21	+ 3.21	16
784 Peake	2 435	2 638	321	15 587	* 14.14	23	+ 1.04	30
785 Spence South	1 491	1 294	168	9 436	12.39	37	- 1.67	47
786 Thebarton	1 767	1 668	271	8 507	18.23	10	- 0.93	42
79 = KINGSTON								
791 Brighton	2 547	2 890	422	16 441	*14.45	22	+ 1.67	24
792 Glenelg	2 853	3 043	446	16 472	*16.02	17	+ 0.92	32
793 Hanson South	1 465	1 671	212	7 245	*18.52	7	+ 2.27	19
794 Mawson	1 879	4 194	654	15 455	*13.11	32	+11.96	5
80 = PORT ADELAIDE								
801 Albert Park	1 788	1 640	192	12 493	11.73	40	- 0.95	44
802 Angle Park	391	476	11	3 590	* 8.96	48	+ 1.89	23
803 Price	3 196	2 972	550	16 289	17.30	14	- 1.10	45
804 Semaphore	2 412	2 376	717	16 674	14.84	20	- 0.17	39
805 Spence North	903	864	61	6 397	11.57	42	- 0.49	41
81 = STURT								
811 Coles	2 418	2 888	370	17 074	*13.06	33	- 2.20	20
812 Davenport	2 267	2 438	346	14 836	*14.09	25	+ 0.92	32
813 Gilles East	1 421	1 584	75	9 031	*13.25	30	+ 1.44	27
814 Highbury	1 506	3 018	277	12 537	*11.38	43	+ 9.65	7
82 = WAKFIELD (Pt.)								
823 Goyder (part)	65	102	2	588	* 9.12	47	+ 5.03	11
(whole)	1 063	1 036	199	9 584	10.31		- 0.23	
824 Light North (part)	519	596	231	4 501	*13.33	29	+ 1.37	28
(whole)	893	994	335	8 292	*11.85		+ 0.97	
A.S.D.TOTALS	76 591	89 521	11 088	461 884	*15.18		+ 2.24	

Source: Data supplied by State Electoral Department, Adelaide, South Australia.

Notes: t = time span 12/3/70 to 11/6/71 (data taken for 15 months and adjusted to express as annual rates).

Column 1 Et = all deletions from rolls
2 It = all additions to rolls
3 Mt = notified changes of address registered in rolls
4 Pt = the mean electors on roll during the period
5 Tt = population turnover
where $Tt \geq Et$ $Tt = \frac{Et + Mt}{Pt}$

* where $Et > It$ $Tt = \frac{It + Mt}{Pt}$

7 Nt = $\frac{It - Et}{Pt}$

Code No.	Subdivision	Code No.	Subdivision
71	ADELAIDE	78	HINDMARSH
711	Adelaide	781	Beverley
712	Florey West	782	Hanson North
713	Gilles West	783	Henley Beach
714	Ross Smith	784	Peake
715	St. Peters	785	Spence South
716	Torrens	786	Thebarton
72	ANGAS [part]	79	KINGSTON
722	Fisher East	791	Brighton
724	Heysen North [part] ¹	792	Glenelg
		793	Hanson South
		794	Mawson
73	BARKER [part]		
730	Alexandra [part] ²	80	PORT ADELAIDE
731	Fisher South	801	Albert Park
732	Flagstaff Hill	802	Angle Park
736	Moana	803	Price
		804	Semaphore
		805	Spence North
74	BONYTHON		
741	Elizabeth	81	STURT
742	Florey East	811	Coles
743	Modbury North	812	Davenport
744	Playford	813	Gilles East
745	Salisbury	814	Highbury
75	BOOTHBY		
751	Bragg	82	WAKEFIELD [part]
752	Fisher North	823	Goyder [part] ³
753	Leabrook	824	Light North [part] ⁴
754	Mitcham		
755	Norwood		
756	Unley		
77	HAWKER		
771	Ascot Park		
772	Fisher West		
773	Goodwood		
774	Hanson East		
775	Marleston		
776	Mitchell		

¹ Postcodes: 5066/5134/5136/
5137/5138/5139/5140/5141/
5142/5144/5150/5151/5152/
5153/5154
² Postcodes: 5157/5168/5170/
5171/5172/5173/5174
³ Postcodes: 5110/5117/5120
⁴ Postcodes: 5116/5118

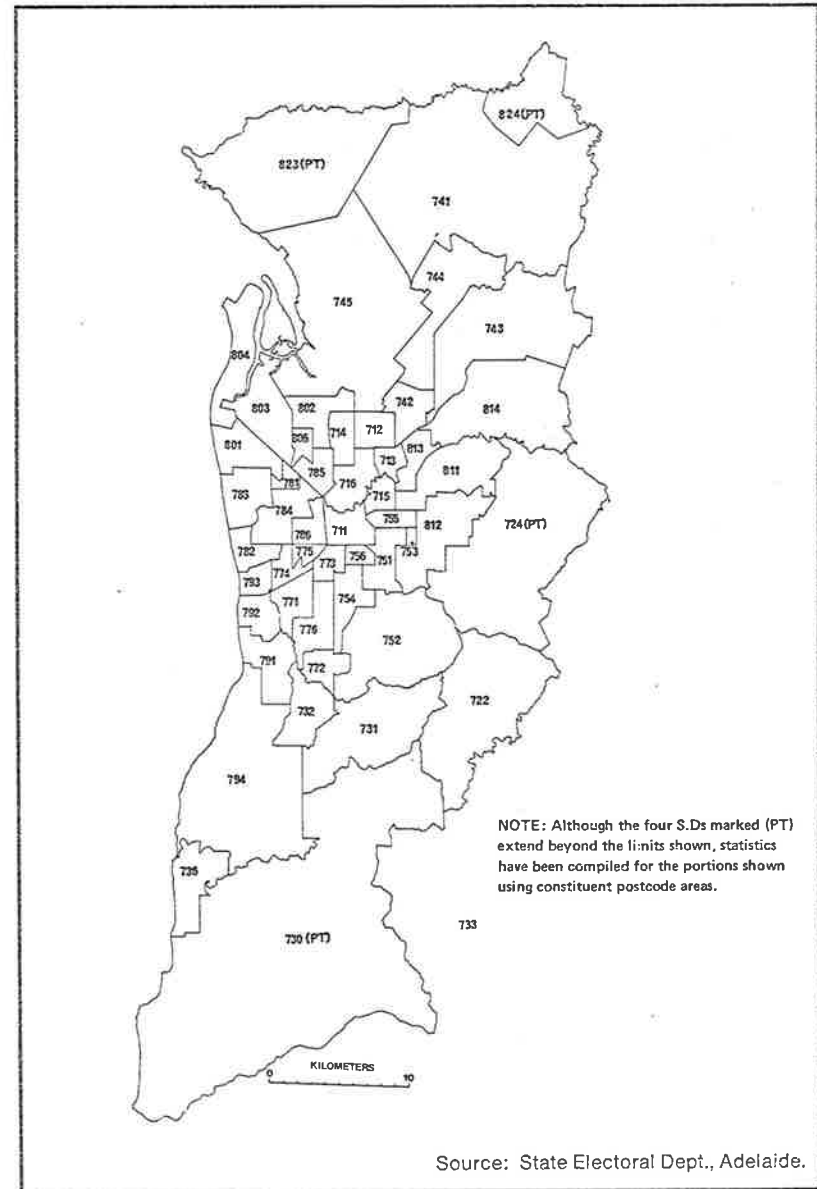

KEY TO CODE NUMBERS, NAMES AND LOCATION
OF ELECTORAL SUBDIVISIONS

Key to names and computer code numbers of electoral subdivisions
(S.D.s) within the Adelaide Statistical Division (A.S.D.) March, 1970.

the problems of manipulating rates of natural increase and is appropriate in the present case. It may be described as follows. For a given time span (t) the formula is -

$$\text{Net migration (Nt)} = \frac{I_t - E_t}{P_t}$$

I_t represents the number who move into the study area.

E_t represents the number who move out of the study area.

P_t represents the mean population during the study period.

In applying the formula to this present study of electoral movement, the following information from subdivisional electoral rolls was utilized.

t - time span 12/3/70 to 11/6/71 (taken as 15 months)

I_t - all additions made to each roll,

(Thereby includes, along with genuine moves into an area, those living there already who turn 21 years or become naturalized).

E_t - all deletions from rolls.

(Thereby includes deceased electors as well as genuine transfers out of the subdivision).

P_t - mean population of electors determined from enrolment at the beginning and end of the time span.

The self-compensating errors mentioned above were accepted at this stage as impossible to eliminate completely but on the grounds discussed in Chapter 3 these are unlikely to invalidate the broad patterns being sought for the total study area.

The statistics utilized in this index for each subdivision are shown in Table 4.3 while the map (Figure 4.3) shows the spatial

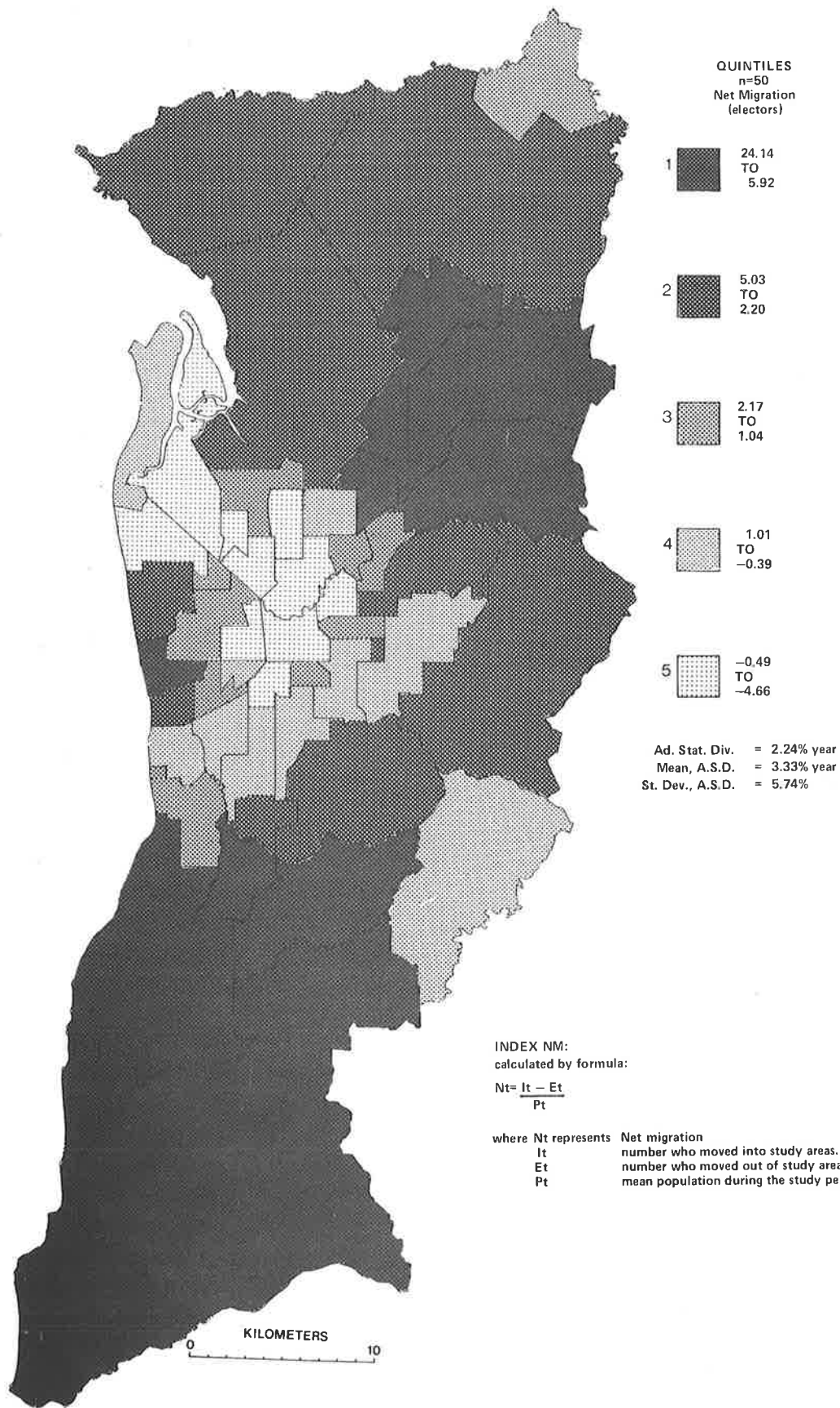

FIG. 4.3: (Index NM) Percentage annual net migration of electors, 1970-71.

Source: Data supplied by State Electoral Dept., Adelaide.

distribution in quintiles. This may be compared with net migration in Local Government Areas (see Figure 3.4/3) for 1966 to 1971. Although the use of different spatial units makes comparison rather difficult, the general impression is clear that there is considerable similarity. High growth areas consist of two separate contiguous blocks one to the south and the other to the north-east of the C.B.D. The latter is somewhat of a reduced version of that in the L.G.A. map where the use of fewer areas shows less detail. Although there is also general agreement in areas of decrease in both L.G.A. population and electors in subdivisions there are some interesting differences. Norwood (S.D.755) shows slight electoral increase in 1970-71. Unley (S.D.756) also experienced slight growth despite losses in surrounding subdivisions. Unley L.G.A. showed a very slight overall increase in the five years to 1971. These two cases suggest the possibility of there having been a local reversal from negative to positive population change. A boom in the construction of flats which developed in these areas during this time may account for this in part.

It is important to note for the whole study area the much higher mean annual rate of net migration of electors (2.24 per cent in 1970-71) compared with the mean annual rate of net migration for the intercensal population (0.88 per cent in 1966-71). This is likely to be due, at least in part, to the fact that persons already living in an area become enrolled on reaching age 21 years thereby inflating the count of inmoving electors.

4.3.2 Population Turnover Index

By its very nature the net migration index is a poor indicator of the amount of residential movement taking place in an area. It merely represents the end result of whatever undisclosed amount of movement is occurring.

An index of population turnover has been devised to describe the proportion of a population which is being replaced in a given time. Turnover is thus being equated with replacement activity. As described by Moore (1971) the parameters necessary to calculate an index for a given time (t) are as follows.

E_t the number of residents who leave the area.

I_t the number who enter the area as residents.

M_t the number who change residence within the area.

P_t the mean population for the study period.

The formula has two forms, one for areas experiencing a population decline (that is where $E_t > I_t$) and another for areas where the population is static or increasing (where $I_t \geq E_t$).

The formulae

(1) where $I_t \geq E_t$

$$T_t = \frac{E_t + M_t}{P_t}$$

(2) where $E_t > I_t$

$$T_t = \frac{I_t + M_t}{P_t}$$

The derivation of population turnover indices was achieved in this present study through use of the following measures taken from sub-divisional electoral rolls.

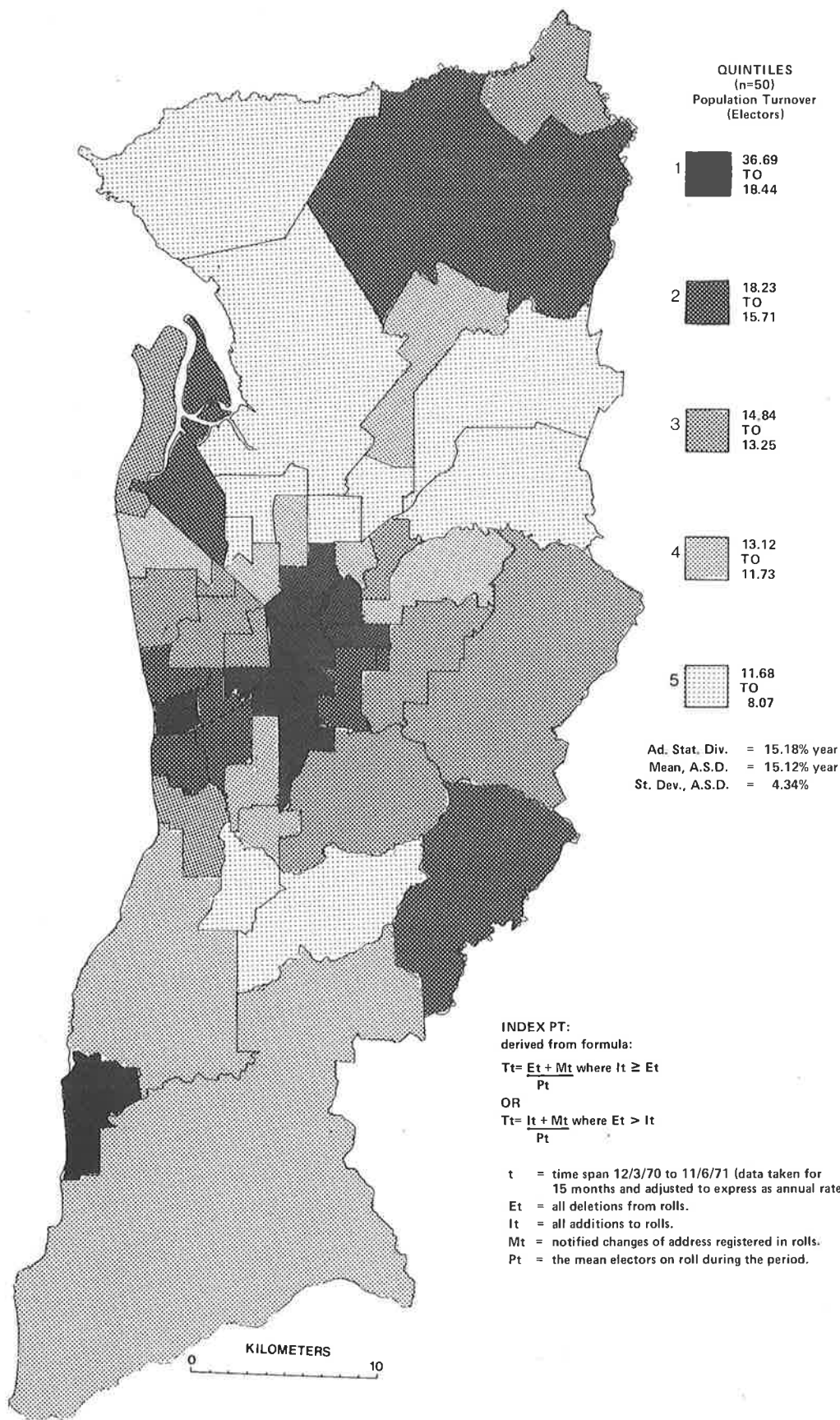

FIG. 4.4: (Index PT) Percentage annual population turnover of electors, 1970-71.

Source: Data supplied by State Electoral Dept., Adelaide.

t - time span 12/3/70 to 11/6/71 (data taken for 15 months and adjusted to express as annual rates),

Et - all deletions from rolls,

It - all additions to rolls,

Mt - notified changes of address within subdivisions as registered in rolls,

Pt - the mean electors on rolls during the period,

The problems involved in obtaining a "clean" count for "Mt" were discussed in the previous chapter (section 3.8.2).

A first visual impression of the distribution of annual rates of population (electors) turnover (see Figure 4.4) is that it is almost the reverse of the net migration index (Fig. 4.3). This is to suggest that areas of high growth register low population turnover while areas of low growth have high turnovers. The subjective impression is confirmed by a Pearson Correlation Coefficient of $r = 0.479$ (significant at better than 0.01, df 48). The rates are compared graphically in Figure 4.5,

There are three main areas of greatest intensity of population turnover with rates in the top quintile, above 18.4 per cent per year (see Figure 4.4). The largest is a contiguous zone of inner areas clustered around the C,B,D. It closely corresponds to the areas of lowest net migration, that is greatest population decrease. The north Glenelg area (S.D. Hanson North (782)) not only has high population turnover but a growth rate more than twice the Adelaide mean. Moana (S.D.736) is a rapidly growing outer area on the

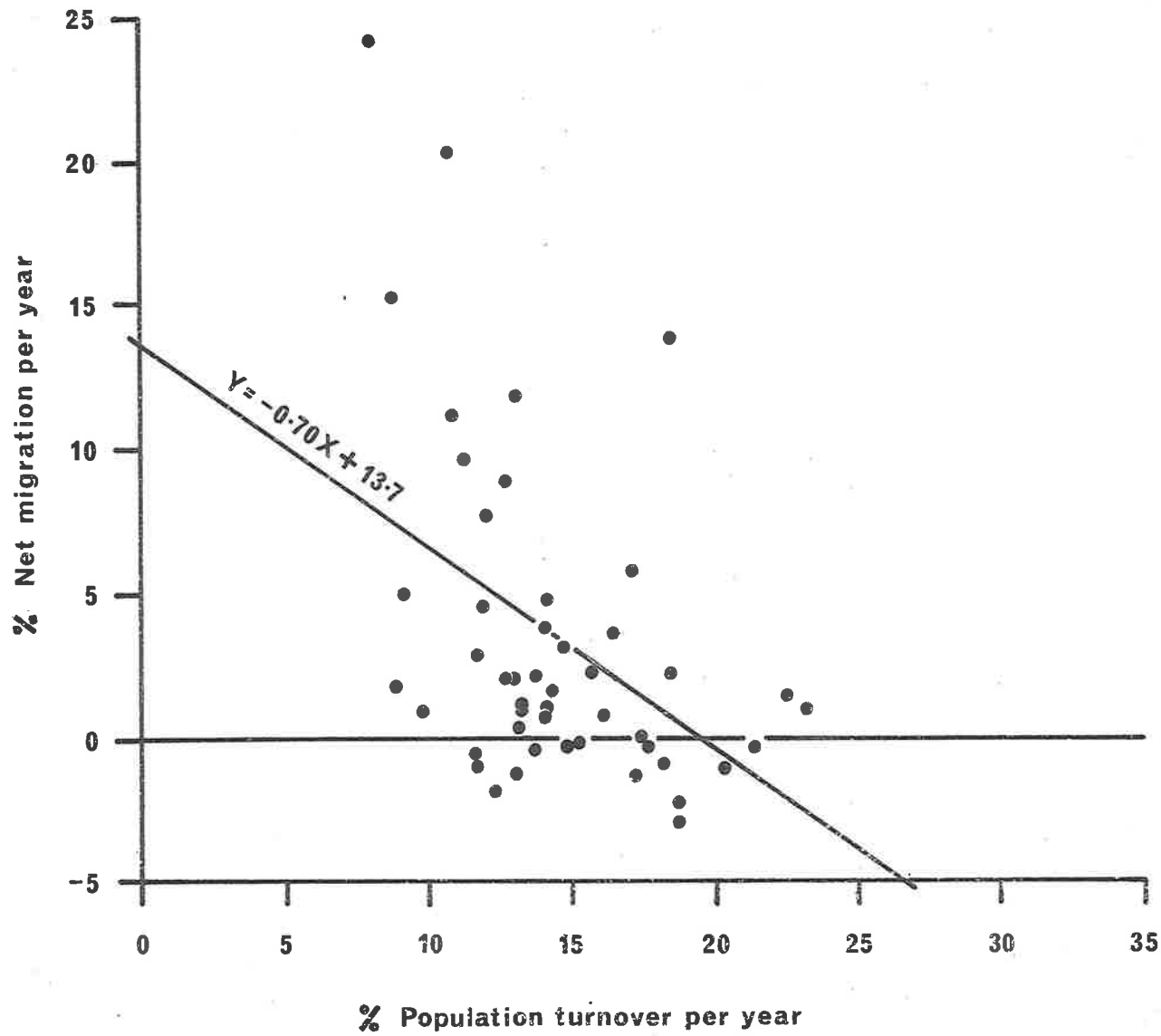

FIG. 4.5. Comparison of percentage annual rates of net migration and population turnover for Adelaide Electoral Subdivisions

TABLE 4.4

Cross Classification of Electoral Subdivisions - Annual
Rates of Net Migration and Population Turnover

POPULATION (Mean) TURNOVER (15,18%yr) (Decile 4)	NET MIGRATION (Growth Rates) mean 2.24% yr. (Decile 4).		
	HIGH Deciles 1,2,3, over 3.50% yr.	MEDIUM Deciles 4,5,6 3.50% to 1.04% yr.	LOW Deciles 7,8,9,10 under 1.04% yr.
HIGH Deciles 1,2,3 over 17.00% yr.	Moana (736) Hanson Nth. (782)	Norwood (755) Unley (756) Hanson East (774) Hanson Sth. (793)	Adelaide (711) St. Peters (715) Torrens (716) Fisher East (722) Bragg (751) Goodwood (773) Marleston (775) Thebarton (786) Price (803)
MEDIUM Deciles 4,5,6 16.99% to 13.20% yr.	Heyson North (724) Elizabeth (741) Fisher Nth. (752)	Leabrook (753) Beverley (781) Henley Beach (783) Peake (784) Brighton (791) Gilles East (813) Light Nth. (824)	Mitcham (754) Ascot Park (771) Glenelg (792) Semaphore (804) Davenport (812)
LOW Deciles 7,8,9,10 under 13.20% yr.	Alexandra (730) Fisher South (731) Flagstaff Hill (732) Modbury Nth (743) Playford (744) Fisher West (772) Mawson (794) Highbury (814) Goyder (823) Florey East (742)	Gilles West (713) Salisbury (745) Angle Park (802) Coles (811)	Florey West (712) Ross Smith (714) Mitchell (776) Spence Sth. (785) Albert Park (801) Spence Nth (805)

southern coast also with a high population turnover,

Areas with the lowest population turnover rates are, ipso facto, the most stable in the sense of having proportionately the least amount of residential change. There are two separate areas where this extreme occurs, marked as the fifth quintile (Figure 4.4). The first area consists of a contiguous block of eight northern subdivisions stretching from the middle suburbs (S.D.s 805, 712) to the outer limits (S.D.s 823, 814) and including areas of decrease and others of high growth. The second block of low turnover consists of two southern subdivisions, namely S.D.s 731 and 732, both areas of high growth.

The most important point which emerges from the discussion is that for any given category of net migration there is a diverse range of turnover rates. This seems to imply that, despite the strong negative correlation between the two indices, it would be difficult to predict with certainty the turnover rate of a subdivision if only the net migration rate were known. To assist in later discussion, subdivisions have been grouped into nine classes according to the combination of scores on the two indices with the categories of high, medium and low (see Table 4.4). The same nine classes are shown on the accompanying map (Figure 4.6),

The mean annual rate of population turnover for electors in the Adelaide Statistical Division was 15.18 per cent, more than six times the annual rate of net migration, 2.24 per cent. However, this rate of turnover is less than the 20 per cent per annum often

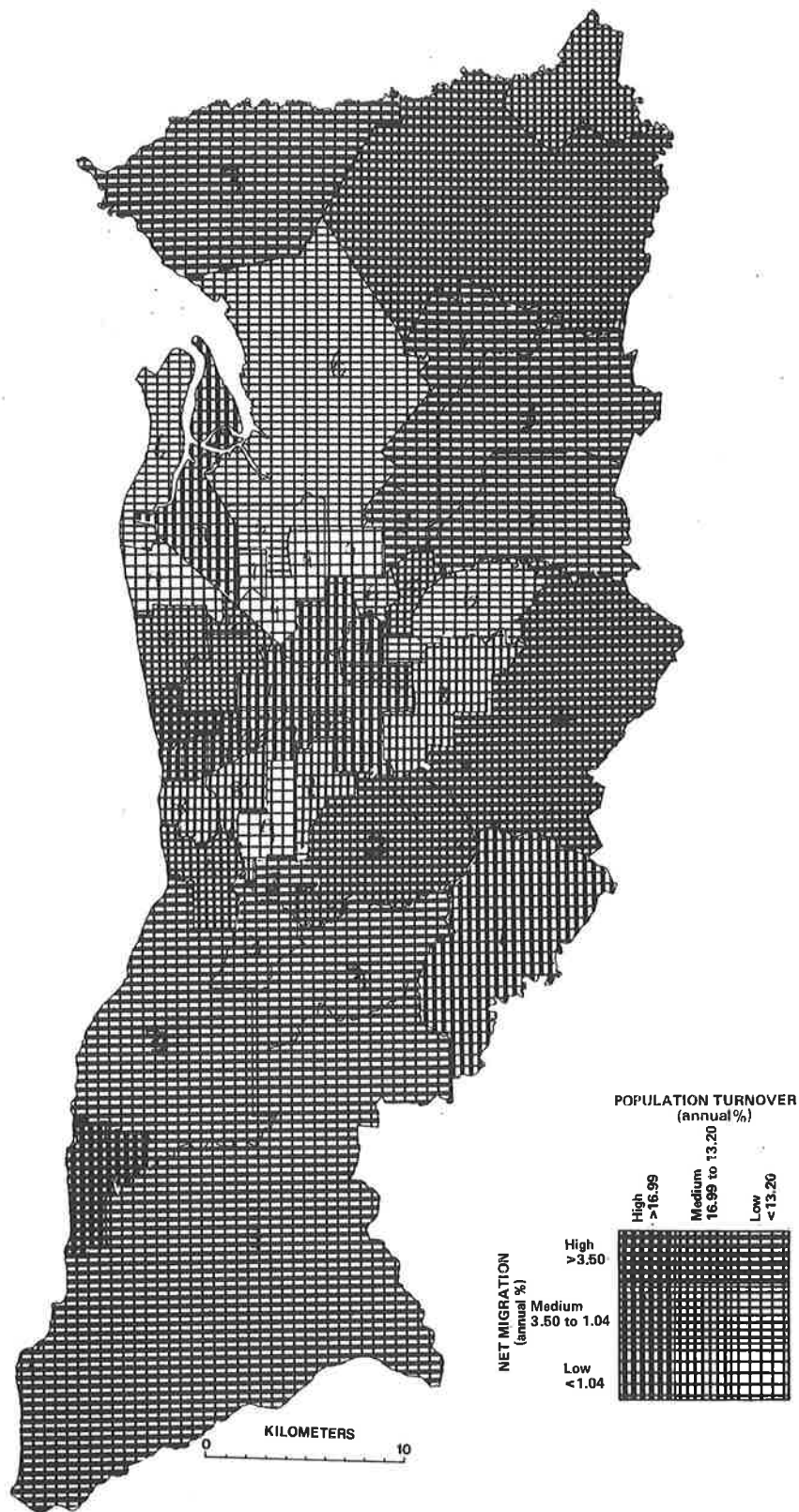

FIG. 4.6: Cross classification of electoral subdivisions on annual rates of net migration and population turnover.

Source: Computations by author of data from State Electoral Dept., Adelaide.

quoted for the United States of America (Rossi, 1955b; Simmons, 1968; Moore, 1972, p.1) and partially confirmed for Melbourne by Whitelaw (1973). Although the index just quoted for Adelaide includes movements internal to the data areas, the rate must be lower than reality because many of the most mobile members of society escape involvement in the statistics by being aliens or under 21 years or just failing to register all changes of address.

An interesting comparison with other data is made possible by the fact that the 1971 census gathered information on the place of residence of respondents at the previous census (1966). The census based data to which the formula for Population Turnover (Moore, 1971) is applied below need some explanation.

Information was supplied by respondents within the Adelaide Statistical Division at the 1971 census and published in A.B.S. Bulletin 7.4 (p.98). Selected data may be applied as follows to the formula (Moore, 1971, p.74) already discussed.

Mt = Number living in different house in same Statistical Division (Adelaide) in 1966.

Pt = Mean of population at 30/6/66 and 30/6/71

Et = Number who moved out since 1966 (excluding deaths).

'Et' is equal to the difference between "potential stayers" from 1966 and those who actually stayed within the Adelaide Statistical Division.

The data and the results are set out in the accompanying Table 4.5.

Table 4.5

Index of mean annual Population Turnover (Tt) 1966 to 1971,
Adelaide Statistical Division.

Mt = 178 800	$Tt = \frac{Et + Mt}{Pt}$
Pt = 807 127	
Et = 121 665	= 7.45% per year

Source: Raw data from Bulletin 7.4, Australian Bureau of Statistics.

In observing that this result is about half that from electoral data three shortcomings in the census record must be remarked upon. Firstly, the question allowed each person no more than one move in the five years between censuses. There is ample evidence in electoral and other records that a very mobile section of society moves much more frequently than that. A few extreme cases move several times per year. Secondly, those who were born or who moved into the Adelaide Statistical Division during the intercensal were excluded from being counted as subsequent movers. Thirdly, persons who moved both into and out of the Division during the five years were entirely lost to the count as were persons temporarily absent when the census was taken. The much higher turnover rate obtained from the electoral roll suggests that the census record falls far short of indicating the real rate of population turnover.

It is true that the visual impression conveyed by maps such as that in Figure 4.4 of rates of Population Turnover are partly misleading because some areas are given exaggerated prominence. The reason for this is that some large territories contain relatively

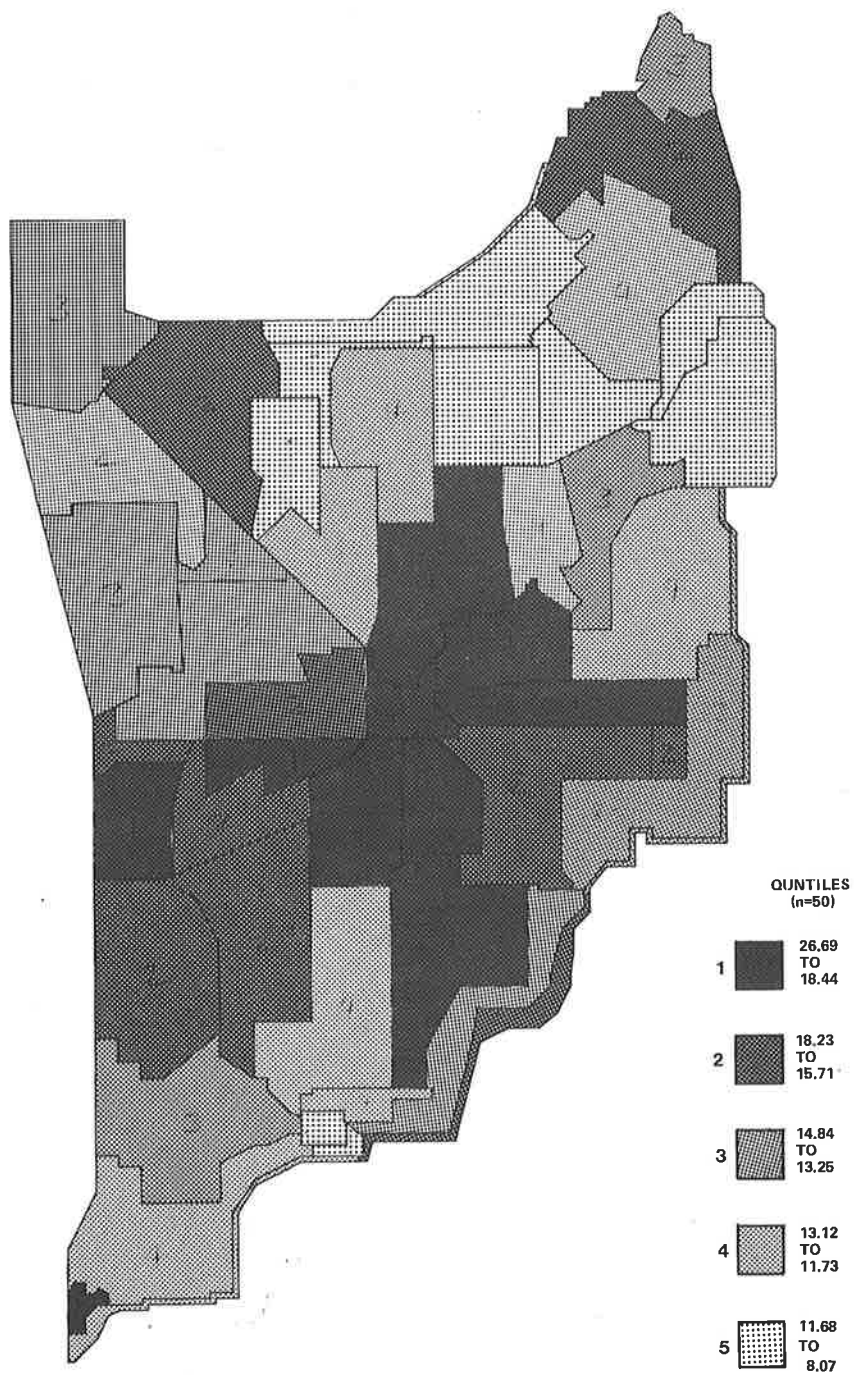

FIG. 4.7: Topological map of annual population turnover, 1970-71, Electoral Subdivisions.

Sources: Base map, T.L.C. Griffin. Raw data, State Electoral Office.

few people compared with some smaller areas which contain large numbers. The conventional map used as a base maintains a linear scale in accordance with terrestrial relationships. A topological map in which the size of electoral subdivisions was scaled according to the number of electors contained would overcome this particular visual bias. Figure 4.7 is an attempt to do this. It emphasizes the relative unimportance on the total urban pattern of the peripheral areas especially those to the east and south. The high turnover rates in the inner suburbs stand out starkly in sharp contrast to the stability of the ring of middle suburbs.

4.3.3 Comparison of movement indices with percentage eligibles on the roll

In section 3.6 of the previous chapter, considerable space was given to discussion of the distribution of the percentage of eligible persons actually registered on electoral rolls. Adjustments were made to the count of eligible persons to minimize anomalies and the suggestion made that a relationship might exist between levels of registration and population mobility. This possibility will be examined now with the aid of the indices discussed in this section.

The two population indices, net migration and population turnover, for the fifty subdivisions in the study area, were compared in turn with the percentage of eligibles on the roll, first the unadjusted figure and then the adjusted figure. The four relationships are set out graphically in Figure 4.8 derived from data shown

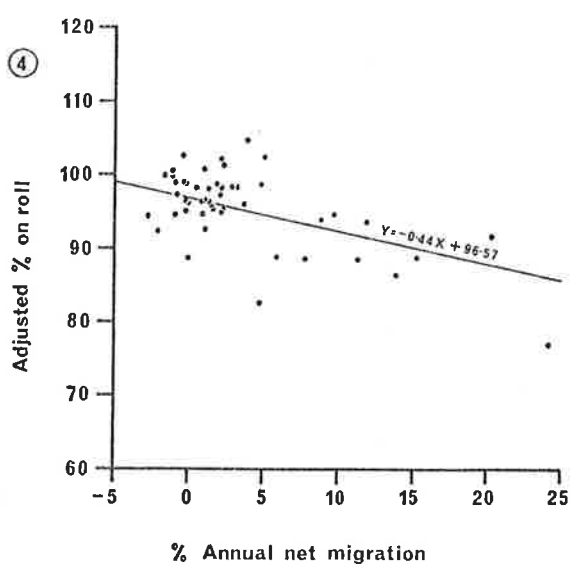
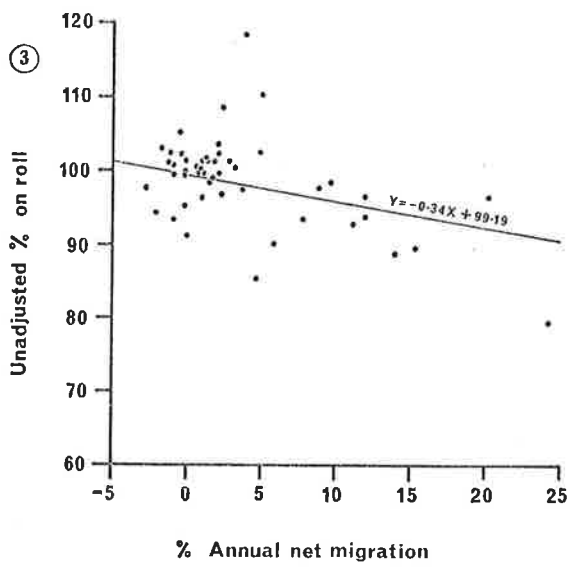
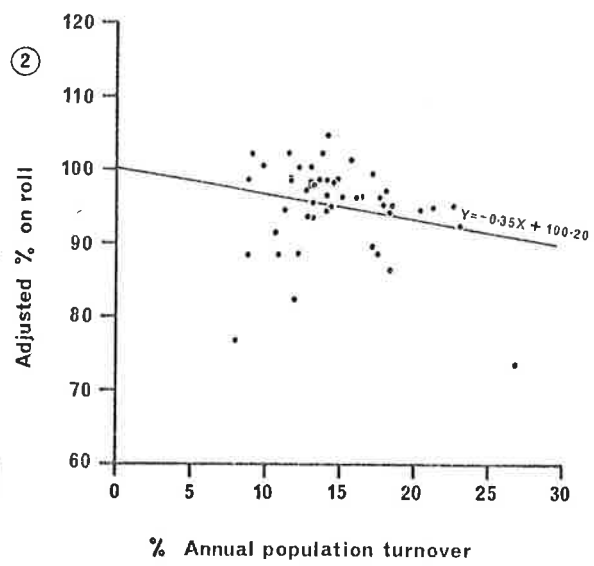
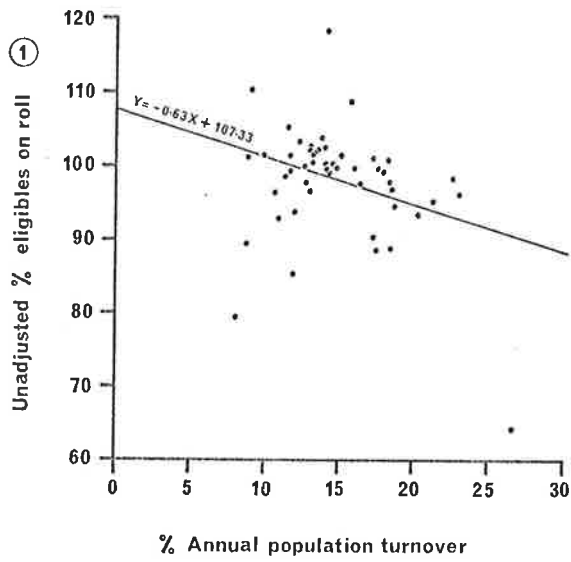

FIG. 4.8. Relationship between population indices and percentage of eligibles (unadjusted and adjusted) on electoral rolls.

in Table 3.5 The correlation coefficients are summarized in the accompanying Table 4.6.

TABLE 4.6

Pearson correlation coefficients between (X) indices of net migration and population turnover and (Y) percentage unadjusted and adjusted of eligibles on the electoral roll, Adelaide Statistical Division

% Eligibles on the roll	Population Index	Net Migration	Population Turnover
		r	r
	Unadjusted	- 0.251	- 0.421
	Adjusted	- 0.314	- 0.224

All coefficients are significant at 0.01 or better on the one tailed test, df 48,

Source: Author's processing of Electoral and Census data.

It is clear that though none of the correlation coefficients is high, the relationships are nevertheless statistically significant. The table shows that with the count of eligibles in its unadjusted state, population turnover is much more closely related (negatively) to it than net migration. The tendency in this case is for areas of high population turnover to have lower rates of registration of those who appear eligible to be electors. This is a logical outcome as highly mobile persons often fail to have themselves registered or enrolments corrected and furthermore the time-lag built into the system (see section 3.7.2) ensures that the proportion in error and waiting to be removed by objection will be higher in such areas. However the relationship is changed after

the count of eligibles is adjusted to compensate for the anomalies (see section 3.6). The magnitude of the negative relationship with net migration increased to the point where it exceeded that of population turnover - the reverse of the situation before adjustment.

The shift in the relationship indicates that the anomalies removed were more positively associated with areas of high turnover and negatively with areas of high net migration. The adjusted state shows that net migration is more significantly related (negatively) with percentage eligibles on the roll. Thus the tendency is for areas with higher rates of net migration to have lower proportions of eligibles actually registered on the rolls. Such areas are typically newly built-up with high inflows of new residents with personal settling-in problems. Coupled with the time lags of the electoral registration system, the result is as expected.

It can be claimed then that the spatial relationships as shown on the maps (Figs. 3.13/1 and 3.13/2 and Figs. 4,3 and 4,4) are as follow. The map of population turnover indices more closely resembles that of the unadjusted percentage eligibles on the electoral roll. On the other hand the distribution of net migration indices has a similarity closer to that of the adjusted percentage eligibles on the electoral roll.

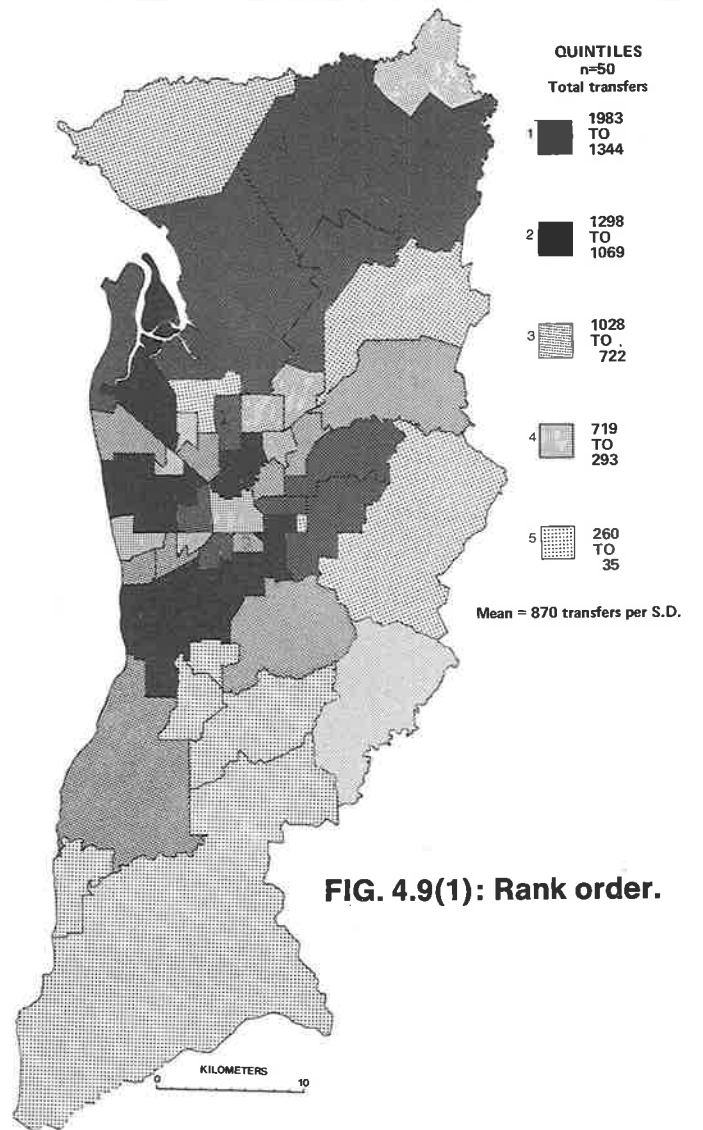
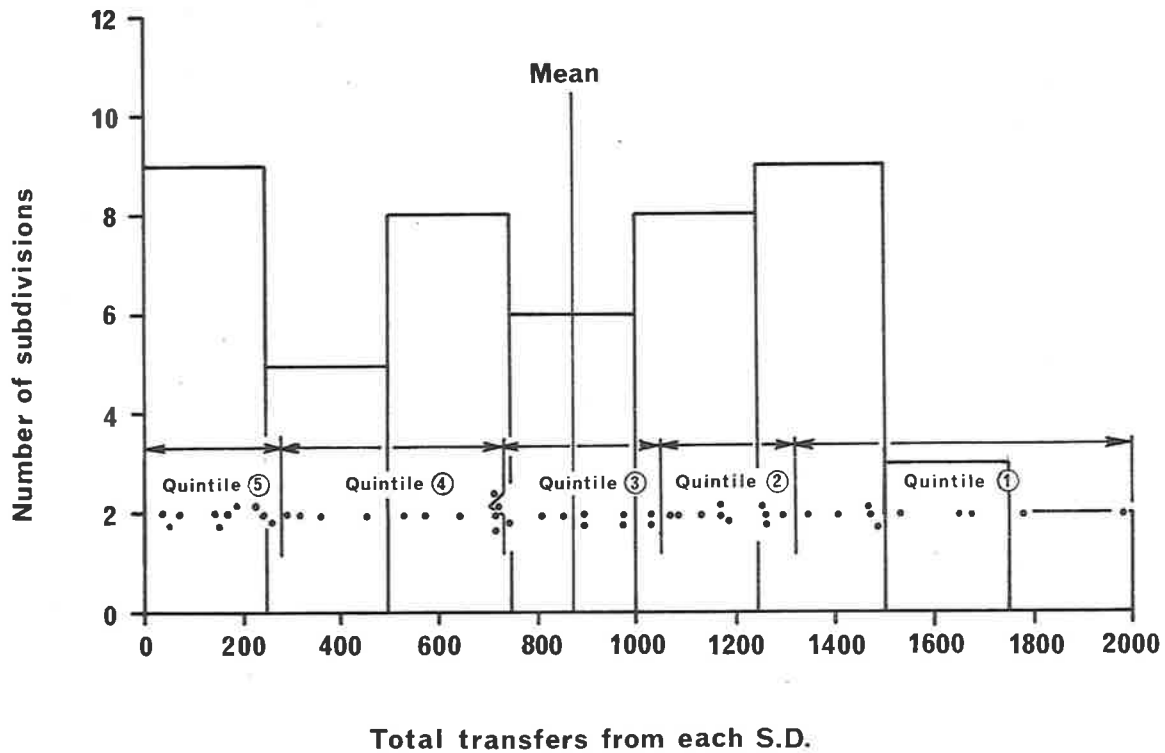

FIG. 4.9: Total electoral transfers from subdivisions 1970-71. Source: Compiled from data supplied by State Electoral Dept., Adelaide.

4.4 MOVERS/OUTMIGRANTS

4.4.1 Outline

The movement indices already described make use of counts of electoral movements both in and out of subdivisions as designated origin areas. The electoral roll also provides flow linkage information between subdivisions because it records the subdivisional destination of each transfer. Although analysis of this record is the basis of discussion in later chapters, some preliminary matters will be examined here.

First to be discussed will be the fact that regardless of the size of the resident population in origin areas it is the relative size of the actual outflows which will have greatest influence in changing population patterns in the total urban context. Secondly, consideration will be given to the division of movement between destinations within and without the Adelaide Statistical Division - loosely described as urban and rural respectively.

4.4.2 Relative importance of donor areas

The base of the topological map shown earlier in Figure 4.7 was scaled according to the relative size of the mean electoral population, thereby giving a visual indication of the relative potential of individual subdivisions to contribute to the total movement patterns of the city. In the compilation of the accompanying Figure 4.9 subdivisions were ranked according to the total number of transfers as displayed in the graph. This makes clear the wide, fairly uniform, spread of values where the greatest is about

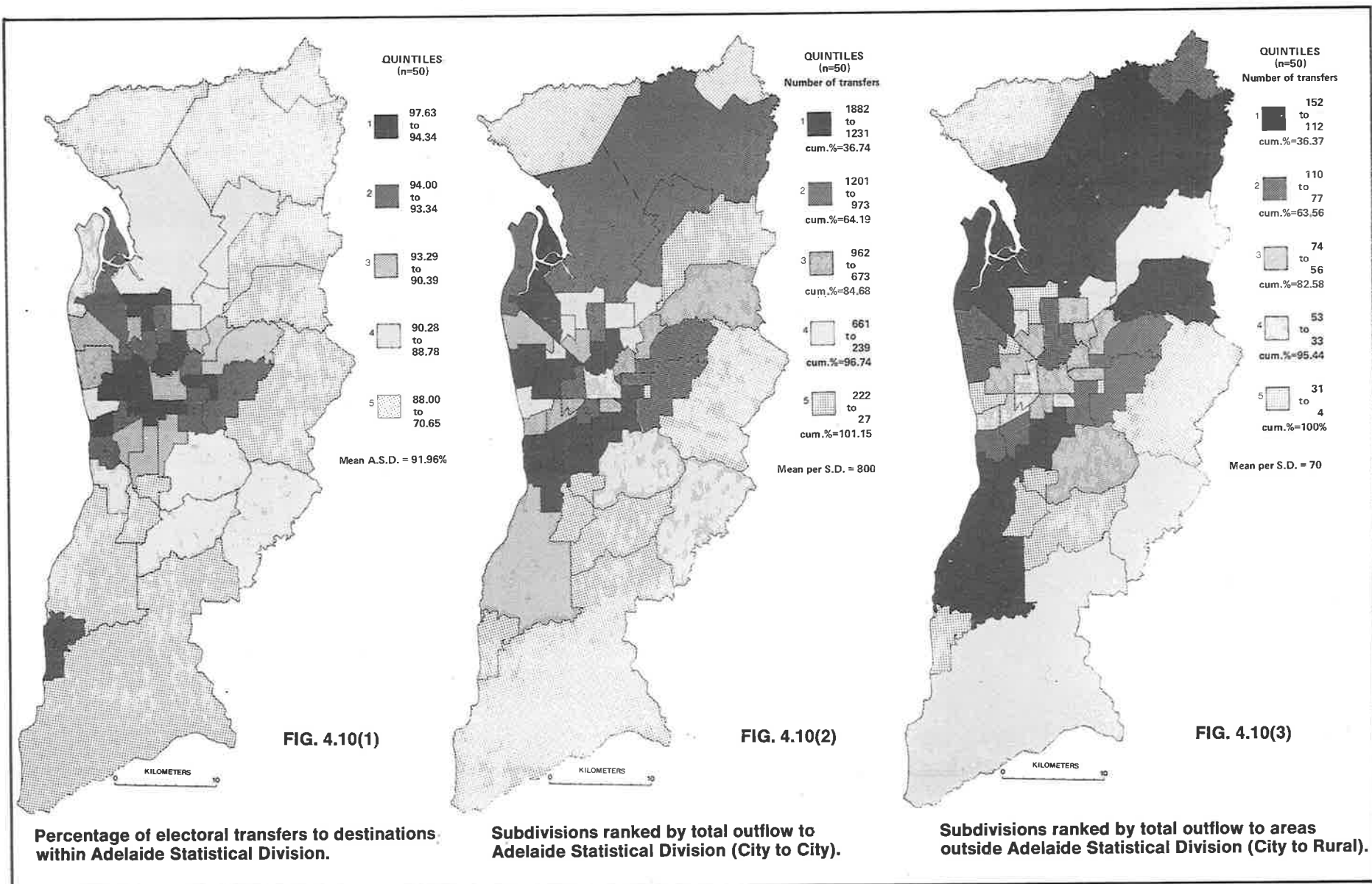

FIG. 4.10: Out-transfers of electors from electoral subdivisions, 1970-71. Source: Data supplied by State Electoral Dept., Adelaide.

fifty times larger than the smallest. The map reveals the dominance of the middle suburbs, especially the contiguous band from Burnside to Glenelg and another stretching west of the C.B.D. to the coast at Henley Beach. The subdivisions with the largest numbers of transfers are Torrens (716) which contributes almost five per cent of the overall total and Price (803) which is only a half per cent behind. The smallest numbers of transfers generally occur in outer suburbs except for Leabrook (753) and Angle Park (802) which are small areas in the middle suburbs. Spatially the general impression therefore is that from a low score in the central city there is a progressive increase with distance until the middle suburbs where the largest outflows occur beyond which there is a decline with distance.

4.4.3 Comparison of out-migration to areas within and without the Adelaide Statistical Division

Maps of the accompanying Figure 4.10 show the distribution of electors from subdivisions in the study area. In the first map areas are ranked according to the relative proportion of out movement destined for subdivisions within the Adelaide Statistical Division here loosely referred to as "city" or "urban". The complementary portion of this movement is directed elsewhere in South Australia and referred to as "rural". The other two maps of Figure 4.10 utilize rankings of outflows by absolute size according to whether they are destined for city subdivisions (map 2) or rural subdivisions (map 3).

Of the 43,494 transfers known to have occurred in the study area during the period under review, 91.96 per cent were destined to end within the Adelaide Statistical Division and only 8.04 per cent (3,946 transfers) went to other parts of South Australia. This was disproportionate to the populations contained because the study area houses almost 72 per cent of the state's population. Inspection of the map suggests that there is a fall off with increasing distance from the C.B.D. in the proportion of transfers which terminates within the study area. Spearman's Rank Correlation Coefficient ($R = -0.409$) confirms this as a significant relationship (at better than 0.005 df 48). Expressed from the reverse point of view, there is an increase in the proportion of transfers destined for rural areas with decreasing distance from the C.B.D. or increasing proximity to rural areas. Perhaps this is associated with probability of previous contact with persons and places in contiguous areas. These ideas are discussed by Hägerstrand (1957, pp.132-152) and have been summarized in the following terms:

Migration depends on the number and time frequency of movements, on contiguity and on previous contact (migration) from the same area. (Morrill, 1965a, p.40)

Several interesting features of the map (see Fig. 4.10/1) warrant further comment. For example, despite the trend just noted, the percentage of transfers to the city from the central area (S.D.711) is only about average for the whole city. However, the subdivisions in the ring surrounding this are mainly in the top

quintile with a strong intermingling from the second quintile. In the outer area Moana (S.D.736) stands out even though numerically small as shown in Figure 4.9. It is ranked in the second quintile of city-directed flows (Fig. 4.10/1) and appears anachronistic because it is surrounded by areas in the lowest quintile. The explanation lies in the fact that the area is still a popular retirement and holiday home centre from which some urban dwellers with two homes commute. At the 1971 census Moana ranked third of fifty subdivisions on absolute numbers of holiday homes which comprised 27 per cent of its houses. To summarize the observed trend in transfer attachments it may be stated that links with rural areas are relatively most numerous from subdivisions closest to them. Conversely areas most intensely urban in their choice of transfer destinations are the inner-middle subdivisions.

Map 2 of Figure 4.10 ranks subdivisions according to the absolute number of transfers to city destinations. This emphasizes the relative importance of areas as contributors to the total pattern of intra-urban migration. The almost complete dominance of urban destinations as compared with rural ones is further illustrated by the fact that the maps Fig. 4.9/1 and Fig. 4.10/2 have only two minor differences - that is to say the patterns of intra-urban transfers and total transfers are almost identical. Therefore the comments made under section 4.4.2 are applicable here and need not be repeated.

Although transfers to rural areas represent only 8 per cent of the total originating within the Adelaide Statistical Division

their ranked distribution is interesting. The coastal subdivision of Brighton (S.D.791), the outer northern suburb of Elizabeth (S.D.741) and the middle suburb of Mitcham (S.D.754) are the top three subdivisions on absolute numbers of rural transfers. The top ten subdivisions between them contribute over 36 per cent of the movement to rural areas. Only four subdivisions appear in the top quintiles of both categories of transfer destinations. Nevertheless it is true that a considerable similarity exists between the rankings of subdivisions for the two destinations "urban" or "rural". Spearman's Rank Correlation Coefficient was $R = 0.781$, significant at much better than 0.005, $df = 48$.

4.5 ACTIVE LINKS

From the electoral record it is possible to compile a matrix of intra-urban transfers such that the origin subdivisions are listed down the side and destinations across the top. The cells will each contain the number of electors involved in what may be thought of as movement along a particular connecting path or link. In the Adelaide Statistical Division there are fifty subdivisions and therefore a total of 2450 possible links between them, excluding the fifty self-to-self cells. As it is most unlikely that all the possible movement link options will be taken up a useful comparison may be made between subdivisions on the basis of the extent to which the possible links are in fact utilized as "active links".

For any given subdivision the possible maximum number of active links is forty-nine. The graph in the accompanying Figure 4.11/1 plots subdivisions cumulatively against the number of

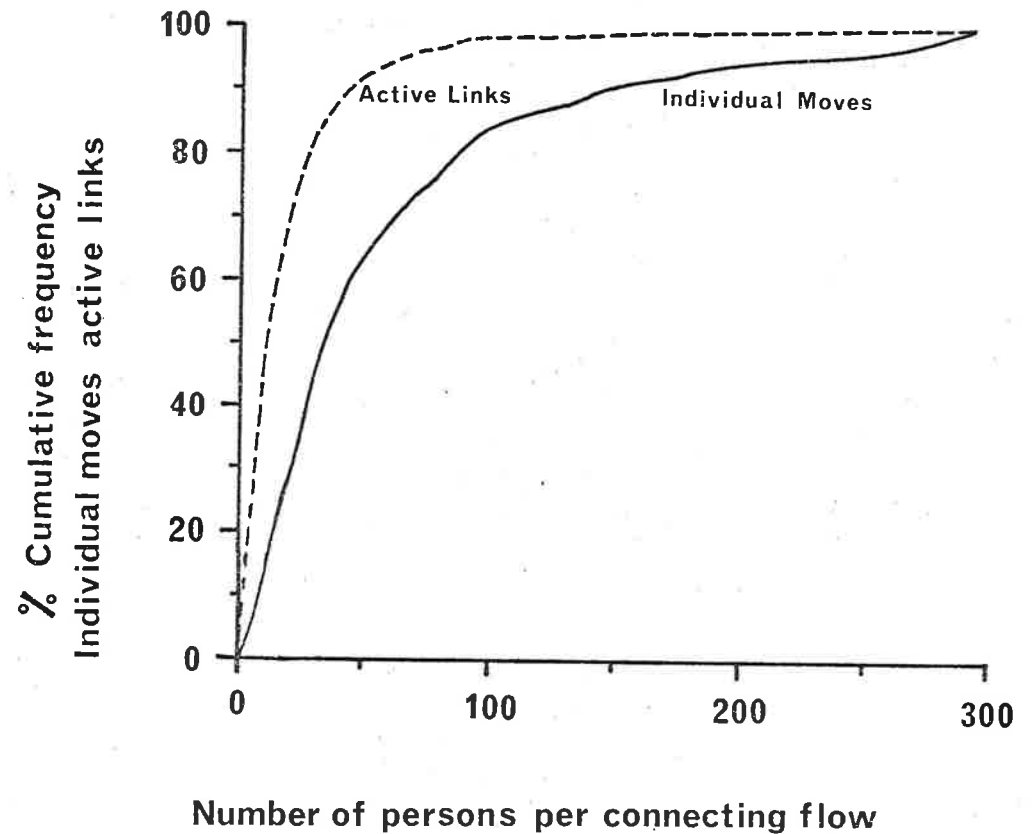
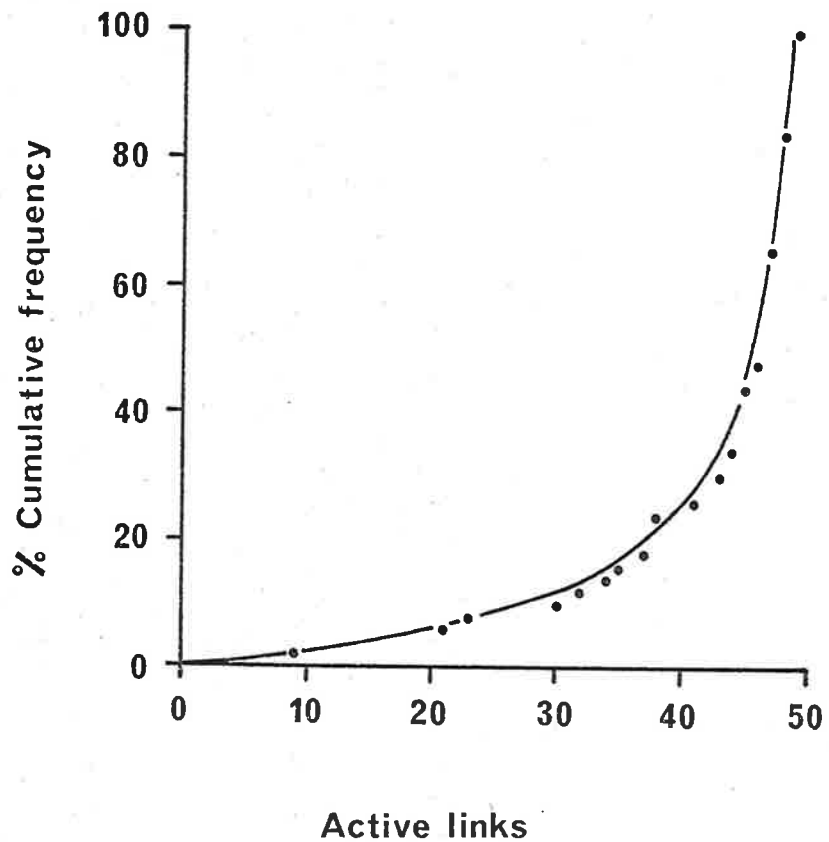

FIG. 4. 11. Cumulative frequencies of active links and individuals moves,(1) Cumulative frequency of active links utilized by origin subdivisions,(2) Comparison of cumulative percentages by volume of connecting flow for active links and individual moves.

active links. Although the mean is 42.6 active links the distribution is strongly negatively skewed with thirteen subdivisions (26 per cent) having forty or less active links, while 26 (52 per cent) have 47 or more active links. The spatial distribution of subdivisions according to the number of active links is shown in the map Figure 4.12. This makes clear the full use of destination options by movers from the middle suburbs with rather less use by the inner suburban residents and a distinctly restricted use by movers from outer areas. There is clearly an inverse relationship between distance of origins from the city centre and the spread of exercised choice of destinations for transfers.

The situation may be summarized as follows. Residents of the middle suburbs are surrounded at close range by almost equal residential opportunities in all directions. Choices viewed collectively reveal that almost all options are utilized to some extent. By contrast residents of the outer suburbs being to one side of the whole system or at the outer end of a sector have restricted opportunities for intra-urban movement. The active links originating in outer suburbs, though selected from a city-wide array of possibilities, in fact represent a restricted selection. Without further investigation this general situation seems in keeping with the 'intervening opportunities' theory of Stouffer (1949, p.846) in which "the number of persons going a given distance is directly proportional to the percentage increase in opportunities at that distance."

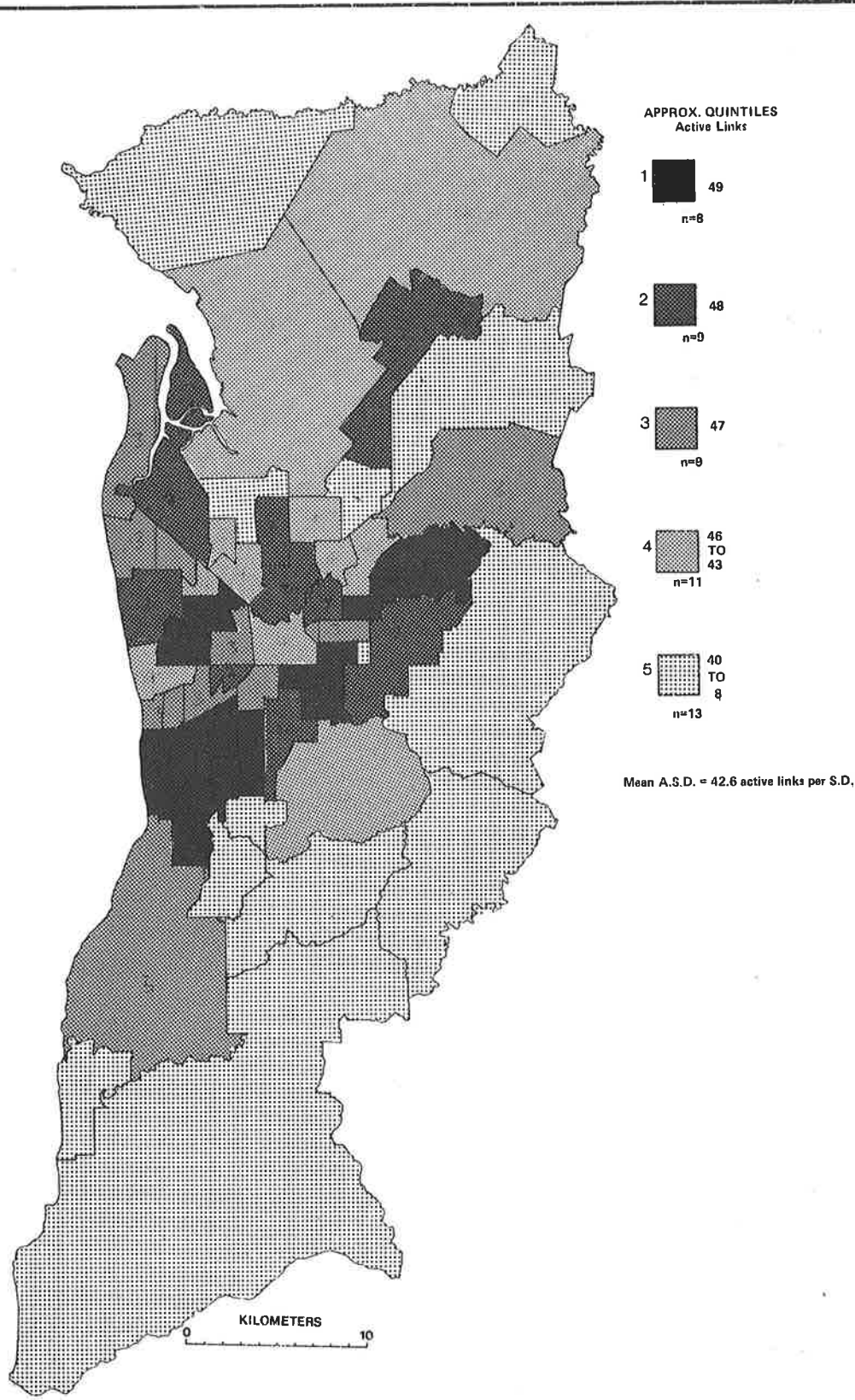

FIG. 4.12: Electoral subdivisions ranked as origins by number of active links (destinations) used by transfers.

Source: State Electoral Dept., Adelaide.

From the possible maximum total of active links (2450) only 2133 are in fact active, about thirteen per cent being unused. Active links may be expected to differ in relative importance according to the number of persons transferring along the particular path. In order to demonstrate this, active links are graphed cumulatively against the number of persons transferring along each link (see Figure 4.11/2). This shows clearly that, though flows may be as large as 290 individual movers, eighty per cent of active links take twenty-five or fewer movers and that only about ten per cent of links each carry in excess of forty intra-urban migrants. The distribution is therefore heavily negatively skewed in favour of a large number of small volume links.

To gauge better the relative importance of the small proportion of large volume links it is necessary to know the proportion of all individual movers carried by them. This information is represented by the lower curve in Figure 4.11/2. In total there are 39,942 individual moves plotted by cumulative percentage according to the size (volume) of the connecting flow in which movers participate. It can be seen therefore that forty per cent of all individual moves occur in flows of twenty-five or fewer persons, but that this accounts for eighty per cent of all active links. For economy of effort in obtaining an overall view of movement patterns it is apparent that not all active links need be considered. For example, by examining the twenty per cent of actual links carrying in excess of twenty-five persons sixty per cent of all individual moves would be included. This topic is discussed in

greater detail in the next chapter where the major theme is flows of intra-urban migrants.

4.6 CENTROIDS

4.6.1 The need for points in a network

This chapter has discussed direct evidence of dynamic change in the spatial distribution of the electoral population. The terms "origin" and "desination" have been used freely to denote the end territories between which "flows" of migrants move along "active links". It has been shown that not only are there differences in the distribution of the electoral population itself but also in its rates of change and turnover. Some reference has been made to changes associated with distance from the central business district. However for further discussion of the associated parameters of movement, distance and direction, it is necessary to impute movement between electoral subdivisions as occurring between certain clearly defined points rather than from territories of varied sizes and shapes. Once a network of such points is established the basic geometry of movement between them is amenable to quantitative description and the way is thereby opened for comparison with models of intra-urban migration. To use the information in this way a simplifying generalization is made. It is that "on average" out-moves from each subdivision originate at the central point and terminate at the central point of the destination subdivision.

The simplest solution to the problem of finding the desired end points is to determine, subjectively if necessary, the geometric

central point of each origin zone. However this method introduces an important source of error. Since zones are assumed to have their populations uniformly distributed within them any departure from this will have an influence upon the measures derived. In the present case the electoral subdivisions vary greatly in both the size of land and population contained (see section 3.7.3). Furthermore there are many easily recognized examples of sub-areas containing no population which would otherwise strongly influence the placement of a mid-point in the subdivision. With this in mind it is desirable to use a weighting process which takes account of differing population densities within the subdivision and so describes not a geometric midpoint of the territory but the mid-point of the resident population itself - a centroid. In employing centroids as the basis of the movement network the assumption is made that within a given origin area moves originate from sub-areas in proportion to the resident population they contain, and conversely, that within destination areas in-migrants are dispersed among subareas according to their relative shares of existing populations.

4.6.2 Determination of centroids

The following procedure^x was utilized in determining the location of a weighted centroid within each electoral subdivision.

x The author is indebted to Mr. Carl Briffa, Lecturer in Mathematics, Murray Park College of Advanced Education for assistance with this technique.

A map was prepared of the entire Adelaide Statistical Division showing for each of the fifty electoral subdivisions the census collectors districts (C.D.s) contained therein. In cases where subdivisional boundaries cut through collectors districts estimates were made of the fractions allocated to the respective subdivisions.

A coordinate reference grid was superimposed upon the map.

The geometric centre of each of the 1290 census collector's districts was marked and its location described with coordinates.

The census population of each collectors district or estimated fraction was noted.

Calculation of the coordinates of the centroid is carried out separately for the 'X' and 'Y' values using the following formula.

$$\text{Coordinate 'X' of subdivision} = \frac{\sum p_j^i x}{P}$$

where p is the population of each C.D. in turn (i to j)

x is the x coordinate of the C.D. mid point

P is the total population of the subdivision (sum of all the p values).

The 'Y' coordinate is found by repeating the procedure with 'y' coordinate values substituted in the formula.

The allocation of initial coordinate values and fractional allocation of split C.D.s was carried out manually. Calculations were performed by computer. The accompanying Figure 4.13 shows the resulting distribution of centroids.

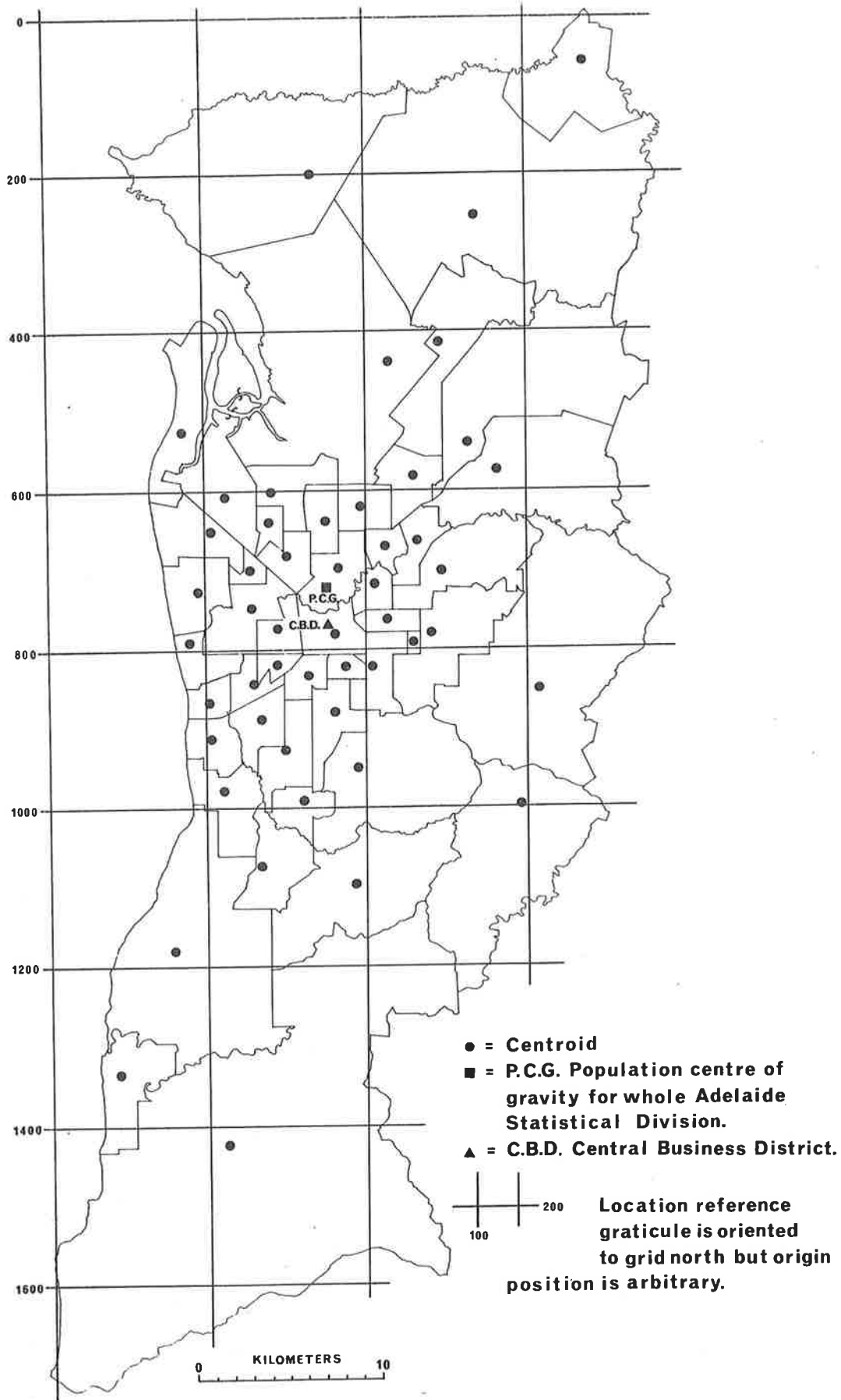

FIG. 4. 13. Location of calculated population centroids in electoral subdivisions, 1971.

Source: Computations by author based upon census data for individual collectors districts June 30, 1971, A.B.S.

With the basic data in the computer it was possible, at the same time as centroid locations were calculated, to determine straight line distances and directions between them. To the system was also added the central business district so that its distance and direction could be determined with reference to all other points in the network. Furthermore the location was calculated of a single "natural" centroid for the entire Adelaide Statistical Division to see how far the C.B.D. was "off centre" to the population it serves. Referred to as the Population Centre of Gravity (P.C.G.) its distance and direction characteristics within the network were also calculated.

The calculation of distances and directions was based upon Pythagoras' Theorem which describes attributes of right angled triangles. This enables all other dimensions to be calculated if the length is known of the two sides containing the right angle. A similar technique was used in a study in Christchurch, New Zealand (see Clark 1971, p.9). The coordinate system of the map is rectilinear and of known spacing (in this case 1 millimetre) so that the line joining any two centroids may be treated as the hypotenuse of a right-angled triangle whose sides are the coordinate grid. The length of the sides may be calculated in millimetres from the coordinate references and the length of the hypotenuse calculated using Pythagoras' Theorem. The angles subtended at each end of the line also may be calculated as measures of direction. Multiplication of the line length by the map scale translates this into real distance.

For ease of reference the body of information so calculated

was set out as two separate matrices. One shows distances between all centroids including the C.B.D. and the 'Population Centre of Gravity', the centroid of the whole Adelaide Statistical Division. The other matrix shows the compass direction of every centroid from every other centroid and also with reference to the C.B.D.

4.7 SUMMARY

The basis of this chapter has been discussion of direct evidence of population movement gathered from electoral rolls, but in particular the computation of standard indices of annual rates of intra-urban migration in Adelaide. A concern, continued from the previous chapter, has been that of demonstrating the degree of similarity of results taken from both census and electoral sources. Using comparable measures on both movers-stayers and net migration, the two data systems were shown to yield spatial distributions with such differences as to suggest that the 'error margin' between them was itself a spatial variable. From this were identified areas of the city for which electoral data was inclined to under-estimate, and others over-estimate, levels of population change in comparison with the census.

The annual rates of both net migration and population turnover proved to be roughly concentric in spatial arrangement, but approximately opposite in their gradation, so that they are probably negatively correlated. Electoral subdivisions were cross-classified on movement rates grouped as high, medium or low. The resulting nine classes will be used in later discussions.

Finally, the calculation for each of the fifty subdivisions of the location of the centroid of its resident population, and of the distances and directions between all such points, provides the basis for further analysis of intra-urban migration in later chapters.

REFERENCES

- Australian Bureau of Statistics (1974) Characteristics of the Population and Dwellings - Local Government Areas, Part 4, South Australia, Bulletin 7.
- CLARK, W.A.V. (1971) 'A Test of Directional Bias in Residential Mobility'. In Perspectives in Geography, I - Models of Spatial Variation. Edited by Harold McConnell and David Yaseen, Northern Illinois University Press, Illinois, pp.2-27.
- HÄGERSTRAND, T. (1957) 'Migration and Area'. Lund Studies in Geography, Series V, no. 13, pp. 27-158.
- MOORE, E.G. (1966a) 'Models of Migration and the Intra-urban Case'. Australian and New Zealand Journal of Sociology, vol. 2, no. 1, pp.16-37.
- MOORE, E.G. (1969b) 'The Nature of Intra-urban Migration and Some Relevant Research Strategies'. Proceedings of the Association of American Geographers, vol. 1, pp.113-116.
- MOORE, E.G. (1971) 'Comments on the Use of Ecological Models in the Study of Residential Mobility in the City'. Economic Geography, vol. 47, no.1, pp. 73-85.
- MOORE, E.G. (1972) 'Residential Mobility in the City'. Association of American Geographers, Commission on College Geography. Resource Paper no. 13.
- MORRILL, R.L. (1965a) 'Migration and the Spread and Growth of Urban Settlement'. Lund Studies in Geography, Series B. No.26.
- MORRILL, R.L. (1965b) 'Expansion of the Urban Fringe: A Simulation Experiment'. The Regional Science Association Papers, vol. 15, pp. 185-199.
- RAVENSTEIN, E.G. (1885) 'The Laws of Migration'. Journal of the Royal Statistical Society, vol. 48, pp.167-235.
- ROSSI, P.H. (1955b) Why Families Move: A Study in the Social Psychology of Urban Residential Mobility. The Free Press, New York.
- SIMMONS, J.W. (1968) 'Changing Residence in the City - A Review of Intra-urban Mobility'. Geographical Review, Vol. 58, no. 4, pp.622-651.

STOUFFER, S.A. (1940) 'Intervening Opportunities: A Theory Relating Mobility and Distance'. American Sociological Review, vol. 5, pp.845-867.

WHITELAW, J.S. (1973) 'Intra-urban Migration'. Geographical Education, vol. 2, no. 1, pp. 75-87.

CHAPTER 5. THE CITY AS A MATRIX: FLOWS, LINKAGES, AND VOLUMES OF
RESIDENTIAL MOVEMENT

Flows and counterflows crisscross the urban area, and these major regularities, such as the tendencies to move nearby and within the same sector, are determined by the procedure for seeking a new home rather than the reason for leaving the old.

SIMMONS (1968, p.637)

OUTLINE

The number of electors transferred during the study period from every subdivision to every other subdivision is recorded in a fifty by fifty matrix which provides the basic data for the core of this thesis. The matrix is presented in this chapter and the volume of flow for every active link is thus identified. Reference is made to a graph (Fig. 4.11) in the previous chapter where size of flow is plotted against a frequency cumulation of active links and number of movers.

Outflows have been mapped separately for each subdivision using proportional arrows to indicate volume of flow. A representative selection only is examined briefly in preparation for more detailed quantitative treatment in the next chapter (Chapter 6).

A general overview of the spatial distribution of flow patterns is provided by examination of the three largest flows from every subdivision. This is followed by a similar examination of the largest 110 flows from the entire Adelaide Statistical Division.

Although some generalizations emerge it is apparent that further quantitative analysis is necessary involving measures of distance and direction.

CHAPTER 5. THE CITY AS A MATRIX: FLOWS, LINKAGES AND VOLUMES OF
RESIDENTIAL MOVEMENT.

CONTENTS

	Page
5.1 INTRODUCTION - THE MATRIX	161
5.2 FLOWS	163
5.2.1 An Overview	163
5.2.2 Selected Examples of Individual Origin Areas	169
5.2.3 Largest Flows	174
5.3 INTERNAL MOVES	178
REFERENCES	180

CHAPTER 5. THE CITY AS A MATRIX: FLOWS, LINKAGES AND VOLUMES OF
RESIDENTIAL MOVEMENT

LIST OF FIGURES

Figure		Page
5.1	Three largest flows from each electoral subdivision in the Adelaide Statistical Division	facing p.163
5.1/A	Diagrams showing for a selection of areas the chain of relationships by first and second order flows of residential transfers	167
5.2	Outmoves from a selection of electoral subdivisions in the Adelaide Statistical Division, 12 March 1970 to 11 June 1971: (1) Graphs showing percentage cumulative frequency of outmoves by number of active links in rank size order (2) Maps showing comparative spatial arrangement of outmoves	under p.169
5.3	The largest 110 flows from electoral subdivisions, Adelaide Statistical Division	facing p.174

CHAPTER 5. THE CITY AS A MATRIX: FLOWS, LINKAGES AND VOLUMES OF
RESIDENTIAL MOVEMENT

LIST OF TABLES

Table		Page
5.1	Electoral transfers between subdivisional origins and destinations, Adelaide Statistical Division, 1970-71	facing p.161
5.2	Matrix showing for each subdivision the number of active links classified by size (volume of movers per link)	facing p.164
5.3	Internal moves: Rank size distribution of changes of address within electoral subdivisions	facing p.179

TABLE 5.1

ELECTORAL TRANSFERS BETWEEN SUBDIVISION ORIGINS AND DESTINATIONS, ADELAIDE STATISTICAL DIVISION, 1970-71.

ORIGINS	DESTINATIONS																																											C-C	C-R Rural	C-All															
	711	712	713	714	715	716	722	724	730	731	732	736	741	742	743	744	745	751	752	753	754	755	756	771	772	773	774	775	776	781	782	783	784	785	786	791	792	793	794	801	802	803	804				805	811	812	813	814	823	824								
711	0	10	11	19	25	45	1	1	5	0	0	2	3	9	2	5	6	44	7	2	28	33	53	18	4	37	22	11	26	6	0	9	27	14	35	15	15	9	10	7	3	14	8	4	14	9	14	14	4	0	660	58	718								
712	5	0	26	47	22	74	6	2	8	0	0	1	17	38	24	29	46	10	11	0	3	14	3	2	0	9	8	5	12	8	2	19	19	9	8	14	4	3	13	1	1	12	10	6	17	8	20	40	5	1	642	73	715								
713	4	21	0	19	21	51	3	3	5	1	0	0	8	24	33	15	10	16	11	5	7	13	7	6	0	14	11	8	6	2	4	16	14	8	4	8	4	4	14	1	1	17	12	1	42	23	21	54	8	2	582	62	644								
714	7	51	30	0	13	284	4	1	5	0	7	3	39	34	15	48	53	17	3	4	18	20	16	16	2	26	8	10	12	9	9	29	14	24	9	4	14	12	21	18	9	24	10	12	27	16	19	58	6	2	1092	77	1169								
715	27	22	37	10	0	76	7	9	8	4	4	2	5	18	17	13	8	57	14	0	30	74	20	23	2	24	11	5	11	5	5	13	19	9	13	14	15	6	27	4	4	13	5	4	94	45	68	58	2	1	962	65	1027								
716	41	66	80	114	76	0	23	19	16	2	0	6	32	49	40	57	43	107	32	14	65	75	65	26	7	44	26	24	27	11	13	54	49	42	28	43	42	24	39	23	9	28	21	8	60	73	40	65	16	9	1873	101	1974								
722	7	0	0	1	11	8	0	242	5	0	3	0	6	0	7	4	7	14	25	0	9	9	4	4	2	5	7	1	6	0	1	9	2	0	2	2	12	8	13	0	2	8	0	1	2	21	1	2	1	0	474	53	527								
724	0	1	3	0	5	3	60	0	7	2	1	0	0	0	3	1	0	2	0	0	3	4	0	0	7	6	1	0	4	6	3	1	0	0	1	1	2	0	5	5	5	30	1	0	0	0	2	1	1	0	0	202	28	230							
727	0	0	0	0	0	0	1	0	3	6	0	5	0	0	0	0	0	0	1	0	0	1	0	0	0	0	0	0	0	0	0	0	0	0	0	0	0	0	0	0	0	0	0	0	0	0	0	0	0	0	0	0	50	6	56						
732	0	0	0	0	0	0	2	1	0	78	0	4	0	0	0	0	2	0	0	0	0	0	0	0	0	0	0	0	0	0	0	0	0	0	0	0	0	0	0	0	0	0	0	0	0	0	0	0	0	0	0	0	0	61	15	76					
736	0	0	0	0	0	0	2	1	0	78	0	4	0	0	0	0	2	0	0	0	0	0	0	0	0	0	0	0	0	0	0	0	0	0	0	0	0	0	0	0	0	0	0	0	0	0	0	0	0	0	0	0	0	0	140	9	149				
741	7	14	11	16	11	38	3	11	13	0	0	4	0	53	32	258	90	13	6	0	8	13	6	11	0	7	8	2	15	9	2	24	21	23	7	9	19	10	7	20	9	4	20	23	4	17	6	23	41	26	10	1024	140	1164							
742	3	16	17	11	11	9	7	2	8	0	0	0	8	0	0	27	35	16	4	2	0	8	13	7	11	0	4	2	2	0	0	0	0	13	6	4	4	5	8	0	8	3	7	16	4	14	7	16	61	0	0	407	52	459							
743	0	3	9	4	6	12	1	3	4	0	4	0	6	17	0	17	8	6	2	1	2	5	1	4	0	2	5	9	4	1	0	4	1	0	4	2	1	1	0	9	0	2	10	2	0	5	2	0	43	0	0	222	38	260							
744	13	16	10	18	19	45	9	7	4	4	2	2	255	45	48	0	146	4	6	0	15	18	5	8	2	7	6	4	8	5	8	9	0	12	6	1	4	3	2	36	14	3	4	11	16	11	10	6	4	11	24	1	20	6	11	41	11	26	1001	127	1128
745	7	12	7	32	15	35	3	6	13	0	2	1	92	47	28	289	0	14	9	0	6	15	8	9	0	12	6	1	4	3	2	23	11	11	7	19	10	7	20	9	4	20	23	4	17	6	23	41	26	10	969	112	1081								
751	18	14	17	11	43	76	27	15	26	3	7	3	15	24	10	16	6	0	79	30	138	99	88	35	8	41	33	16	32	7	8	21	27	7	16	35	45	18	45	11	4	19	8	1	72	187	18	52	4	7	1542	110	1652								
752	6	1	3	1	11	24	23	13	19	26	5	4	4	5	0	3	6	50	0	5	81	20	24	19	37	27	7	7	38	0	4	9	9	3	3	23	20	10	35	1	0	6	4	0	10	22	12	2	2	4	648	74	722								
753	2	0	1	2	4	11	4	1	4	0	0	0	0	2	4	2	0	30	1	0	8	20	6	2	1	0	0	0	2	0	0	0	1	1	4	4	1	0	0	0	4	0	0	7	41	1	2	0	0	0	165	4	169								
754	5	10	3	4	12	57	15	10	15	4	16	3	12	21	19	9	12	153	91	13	0	38	81	61	19	78	18	14	86	3	5	27	36	3	27	48	56	24	71	4	0	14	2	4	18	65	16	34	9	5	1350	137	1487								
755	23	8	18	20	82	54	9	11	9	0	4	1	7	29	24	32	19	96	22	20	33	0	35	20	10	39	13	25	9	4	18	26	7	27	17	24	7	37	8	0	24	11	14	100	85	33	49	8	7	1191	69	1260									
756	23	2	7	12	12	43	7	10	6	4	6	2	14	6	20	14	5	113	31	5	90	22	0	30	7	70	22	16	35	3	3	26	24	6	15	26	28	14	17	6	3	10	3	5	26	26	16	26	5	3	925	53	978								
771	5	2	5	8	12	29	5	7	18	6	17	9	8	10	20	9	8	50	54	4	52	32	24	0	26	64	72	20	112	4	10	44	32	12	28	99	99	47	177	6	6	9	10	3	31	27	15	23	2	4	1376	99	1475								
772	0	0	1	3	2	3	3	3	5	2	3	0	0	0	0	0	0	5	33	4	15	3	2	7	0	4	4	1	3	0	3	1	0	0	10	11	6	14	0	0	1	0	1	0	3	2	3	1	0	162	29	191									
773	21	8	23	15	20	32	14	1	13	0	18	1	12	16	15	18	7	49	32	4	105	35	46	66	13	0	45	30	93	2	6	30	32	18	15	42	40	21	77	12	0	8	15	6	31	38	13	20	3	1	1182	71	1253								
774	5	3	7	8	4	14	5	1	6	6	20	4	12	16	12	7	24	27	2	21	11	16	66	9	31	0	31	45	1	12	44	34	5	17	50	44	44	50	6	0	3	11	2	18	7	9	20	4	5	799	51	850									
775	9	3	1	7	7	12	1	4	7	0	17	3	6	6	3	6	17	24	14	4	12	18	13	27	3	29	59	0	44	2	11	27	30	9	25	39	25	15	40	10	1	5	4	5	13	12	9	24	7	3	672	40	712								
776	12	5	3	12	6	24	9	3	12	9	17	12	14	6	13	12	8	39	56	5	89	27	30	89	21	68	30	19	0	2	10	42	34	7	18	100	59	24	162	9	3	6	14	3	19	18	8	27	8	8	1231	113	1344								
781	2	1	6	9	1	15	0	0	1	0	2	7	2	8	8	6	9	2	0	4	2	3	5	0	7	4	1	7	0	3	33	44	9	9	6	4	2	12	14	2	34	14	12	5	6	3	12	3	1	340	23	363									
782	3	0	4	4	3	9	1	0	2	2	10	0	2	2	4	0	3	8	8	2	9	6	5	2	3	6	7	1	2	7	0	41	27	1	10	12	7	23	16	2	0	4	2	1	3	10	5	5	2	1	287	31	318								
783	5	8	15	18	14	36	18	12	14	0	14	8	15	42	23	35	22	35	37	3	18	15	12	23	5	23	15	29	28	30	61	0	137	22	33	37	50	30	47	59	11	63	42	20	20	20	17	39	11	5	1296	106	1402								
784	16	8	12	22	27	59	14	5	24	2	13	2	9	23	16	32	33	27	33	1	48	29	19	35	11	28	54	30	41	38	41	193	0	33	77	26	44	40	61	31	5	42	13	11	35	28	18	37	7	5	1458	71	1529								
785	6	17	9	32	12	61	1	3	4	0	6	0	8	36	7	16	30	13	9	0	10	20	12	10																																					

CHAPTER 5. THE CITY AS A MATRIX: FLOWS, LINKAGES AND VOLUMES OF RESIDENTIAL MOVEMENT.

5.1 INTRODUCTION - THE MATRIX

The purpose of this chapter is to introduce for simple preliminary analysis the inter-subdivisional movements of electors recorded as having changed residence during 1970-71 within the Adelaide Statistical Division. "Flows" are the main element of analysis. For this purpose a flow is defined as an aggregation of movers who have in common the same origin and destination area and are therefore considered to commence their move, on average, from the same subdivisional mid-point (centroid) and to terminate it at another common centroid. The basic data on flows, derived as already explained from electoral rolls, is presented in a fifty by fifty cell matrix (see Table 5.1). Although discussion is concentrated upon outward movement patterns, shown horizontally in the table, the same data has had considerable preliminary work done on it for inward movement, shown in the vertical columns. Comparison of the two complementary sets of movements would do much to illuminate at the local level the amount and perhaps kind of population change going on through intra-urban movement. However because the overall task is so huge, completion of the analysis and study of inward movement has been left for the future.

The 2,450 cells of the fifty square matrix represent the set of all possible links within the study area, excluding the self to self links. There was discussion in the previous chapter (see section 4.5) of the fact that only 2,133 of these were active links.

The distribution of active links among the origin subdivisions (mean 42.6 links) is graphed in Figure 4.11/1 and the spatial variation in the use of active links is mapped in Figure 4.12. It was suggested that there is an inverse relationship between the number of active links and distance of an origin from the C.B.D. It was shown that there is also an inverse relationship between annual rates of net migration and population turnover but this has not yet been related formally to distance. However, use will be made in this chapter of the cross classification of subdivisions by rates of net migration and population turnover which resulted in nine classes. This was shown in Table 4.4 and Figure 4.6.

As little as fifteen per cent of all migratory movement originating in the study area ends in places outside the Adelaide Statistical Division (discussed in section 4.4.3). About half of this is destined for non-metropolitan parts of South Australia. This suggests that the population in the Adelaide area is behaving residentially as though it resides in an almost closed system with only a small leakage to the outside. Although the leakage is small it is possible that it may be having significant long term effects on the population characteristics of the main donor areas. This would be the case for example if outmovement were selectively sustained of certain age or ethnic components from the parent population. Whether in fact this is currently occurring anywhere in the study area has not been investigated, but is suggested as a worthwhile topic for further research. This would require some supplementation of the data to hand, but as Moore (1969b, p.114) has remarked "it is essential to remember that the city is an open spatial system".

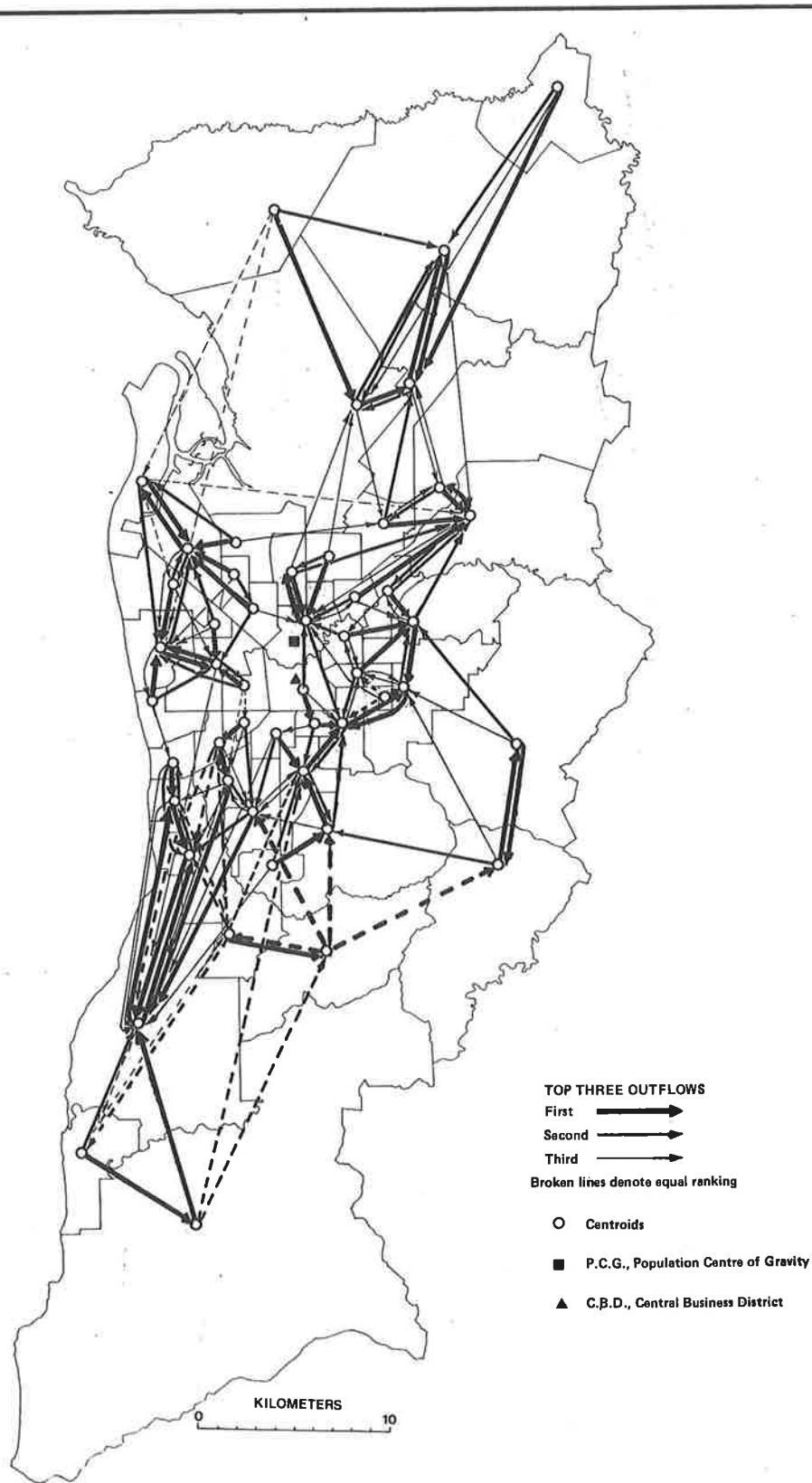

FIG. 5.1: Three largest flows from each electoral subdivision in the Adelaide Statistical Division.

Source: Basic data supplied by State Electoral Dept., Adelaide.

The preliminary analysis to be discussed in this chapter consists of an examination of the spatial distribution of outflow volumes from electoral subdivisions. It begins with a general overview based upon the three major flows from each subdivision and the full flow pattern from a representative selection. However, because the range of flow volumes is very wide, it is necessary to examine more closely the largest ones whose influence on the overall pattern is relatively greater. Finally reference is made to that residential movement, termed 'internal', which takes place within the boundaries of subdivisions. According to the broad definition of migration adopted earlier (section 1.2) any change of place of residence within the defined area forms part of the material of the study.

5.2 FLOWS:

5.2.1 An overview

Generalization in this chapter will be made at several different levels represented by the following collective terms: mutual or reciprocal links, major flows and subsystems. No firm commitment is made to levels of generalization and discussion tends to oscillate between the individual active link and the sub-urban region. The maps in Figure 5.1 show for each electoral subdivision the three largest outflows. "Three" was selected merely as a manageable number. A greater or lesser number must have some, as yet untested, influence on the emergence of patterns. The overall impression of the maps is of a great complexity of criss-crossing lines (see Simmons, 1968, p.637). A closer view

however, reveals distinct channels and nodes upon which the channels focus. It is these patterns of lines and points which call for comment. Table 5.2 sets out for each subdivision the size of its active links arranged according to the number of movers per link.

It is apparent that there are instances where adjacent subdivisions are linked by mutual first choice (see Fig. 5.1). The following list of examples begins in the northwest and ends on the south coast: 803/804, 783/784, 714/716, 744/741, 743/814, 812/751, 722/724, 732/731 and 791/794. The areas included are as diverse as possible and include both the old and well established areas (for example 714/716) and newly developing outer areas (722/724 and 791/794). In many cases one member of a pair is nearer the C.B.D. so that movement between them occurs along a sector either toward or away from the C.B.D. This is reminiscent of the patterns of Dutch and Greek migrant intra-urban moves described by Gibson (1967, p.66). If mutuality is taken to include reciprocal choices even of unequal ranking then the list is expanded to the point where virtually every subdivision has been included in such a relationship. That simply is to say that with few exceptions the greatest outflows from every origin area are destined for adjacent subdivisions. This is an important observation because it is the first of a series of local confirmations of migration principles (see Ravenstein, 1885, especially pp.198-199). In this case the evidence is yet to be refined but suggests that the behavioural preference is for short moves and that there may be distance decay in the number of moves. The most important exception to the pattern of mutual near neighbour choice just described is S.D. 711 (Adelaide).

Its three prime flows are to the nearest adjacent areas but not one flow was reciprocated and no flows of the first three orders were directed to Adelaide. This recalls the indices discussed in section 4.3 where Adelaide was reported as having experienced a heavy net migration decrease.

A closer examination of the flow lines on the map reveals that in most cases each major flow has associated with it a secondary flow in the opposing direction. This is what Ravenstein (1885, p.199) called a "counter-current". Although there were no active links in the first three orders to demonstrate a current running counter to the general outward flow from the central subdivision (711) there is some evidence in the adjoining suburbs. For example the following flows in the inner ring are headed in the direction of the C.B.D.: 805 to 785, 784 to 786, 813 to 715, 753 to 755 and 752 to 751. Of similar lower order and frequency were the following flows directed laterally around the inner ring: 785 to 716, 715 to 716, 716 to 751, 751 to 755, 755 to 751 and 755 to 715.

The method of analysis being followed here treats the study area as a self-contained or closed system so that flows destined for areas beyond the outer boundary are excluded from discussion. As shown in Figure 4.10/3, rural destined flows are an increasingly important component of outflows from subdivisions nearer the outer boundary. Despite the data restriction a little evidence has managed to appear there of a counter flow toward the outer boundary, for example, 732 to 736 to 730, 731 to 722 to 724, 814 to 743. However, no high order flows

were recorded to the northern peripheral subdivisions of 823 and 824.

In socio-psychological studies of group dynamics 'sociograms' devised by Moreno (1946 and 1953) have become a widely used diagrammatic technique (see Evans, 1962, pp.8-29) for representing the interpersonal relationships resulting in the formation of subgroups. The network diagrams drawn are made up of two elements, crosses representing the individuals and lines joining those who share selected positive relationships. In groups with more members than a certain threshold number the typical end-result shows several distinct separate subgroups, often clustered around one or two "key" persons. The aggregated movement preferences shown in Figure 5.1 lend themselves to somewhat similar treatment with subdivisions taking the place of the individual persons in the sociogram.

Following are seven examples selected to illustrate a range of chains of relationships derived from the map (Fig. 5.1) and Table 5.1 and compiled by taking the following two simple steps. Firstly, select as the starting point a subdivision which itself does not receive a first order flow. Secondly, follow its first order flow to its destination, and all the subsequent first or second order flows until the chain ends or turns back on itself. This technique has been applied to a selection of areas and is shown in the accompanying Figure 5.1/A.

(a) FLOWS AWAY FROM THE C.B.D.

1. South and south-east

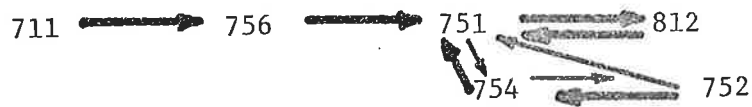

2. South and south-west

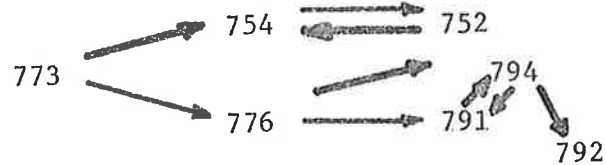

3. North-west



4. North-west

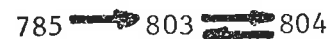

5. North-east

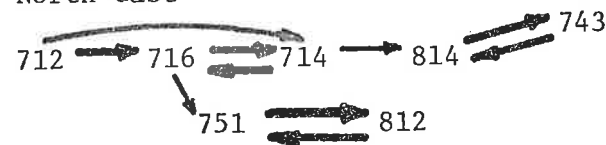

(b) FLOWS TOWARDS THE C.B.D.

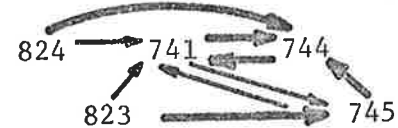

6. Far North



7. Southern coast



KEY

-  first order flows
 second order flows

For Key to S.D. names and locations see Fig. A1 (Appendix A)

FIGURE 5.1/A Diagrams showing for a selection of areas the chain of relationships by first and second order flows of residential transfers between electoral subdivisions

From the above map and diagrams certain subdivisions appear as 'pivot' or 'key' areas about which much of the movement occurs. A tentative list of such areas would include (in numeric code order) 744, 745, 751, 783, 791 and 814. However it must be re-emphasized that the matrix of flows (Table 5.1) indicates an almost complete web of inter-connections with 87 per cent of the possible links being active. Analyses offered here are therefore simple selections of movements separated from their full complicated context.

The following observations and generalizations arise from the discussion of Figure 5.1 and Figure 5.1/A.

(a) There are more or less discrete sets of interconnected flows against a background mass of movement. The sets correspond roughly with sectors after the model of urban structure propounded by Hoyt (1939).

(b) Flows may be interpreted as occurring in the following two main directions; firstly, away from the C.B.D. and inner suburban areas of net migration losses, toward the outer areas of net migration gains, and secondly, lighter flows directed toward the C.B.D. from outer areas.

(c) The middle suburb areas in the sociogram-type chains serve as pivots about which radiate a number of alternative links.

While it is not suggested that any single mover necessarily follows a sequence of residential changes along the "chain" it is suggested that the following is a useful generalization fitting the

observed facts. New housing developments create large numbers of 'new vacancies' generally toward the outer suburban areas, and in attracting residents from existing areas generate a chain of vacancies which can be traced until the chain is terminated or until a vacancy is filled by a migrant from outside the city (Moore, 1969b, p.115). Perhaps in the local application of this behaviour the outer fringe vacancies tend to be filled by people from the nearby outer or middle-suburbs. The vacancies which they create on moving tend to be taken up by people from the inner suburbs who in turn are replaced by people from the central city. The aggregate effect of the continuance through time of this sequence is of a continuous flow of intra-urban migrants emanating in part from the city centre and moving toward the outer-middle suburbs which are also being converged upon by other flows from the outer urban or rural-urban areas. Such descriptions are now commonplace and generally refer to the process as "invasion and succession". Examples have been published by Morrill (1965c) in regard to Negro ghettos in the U.S.A., by Curson (1970) with South-sea Islanders in Auckland and Morrill (1965b) in regard to subdivision of new urban land.

5.2,2 Selected examples of individual origin areas

The preceding discussion made use of three ranked orders of outflows. In so doing, flows within each class were treated as equally voluminous, thereby controlling for volume and enabling concentration on spatial patterns of movement regardless of flow size. That restriction is to be relaxed in this section and consideration given to the spatial differences in volumes of outmigrants

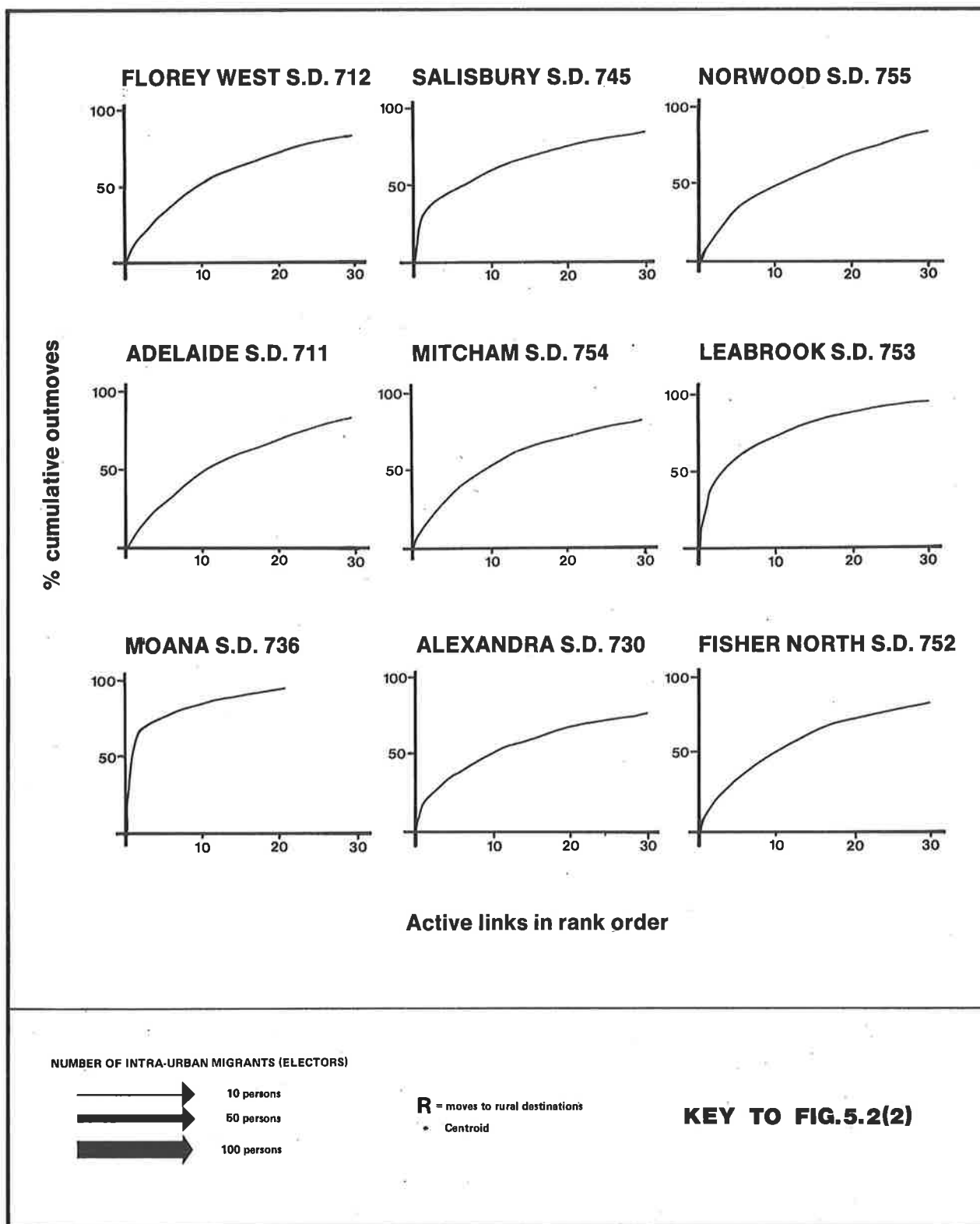

FIG. 5.2: Outmoves from a selection of electoral subdivisions in the Adelaide Statistical Division, 12 March 1970 to 11 June 1971:

- (1) Graphs showing percentage cumulative frequency of outmoves by number of active links in rank size order;
- (2) Maps (on opposite page) showing comparative spatial arrangement of outmoves.

Source: Basic data supplied by State Electoral Dept., Adelaide.

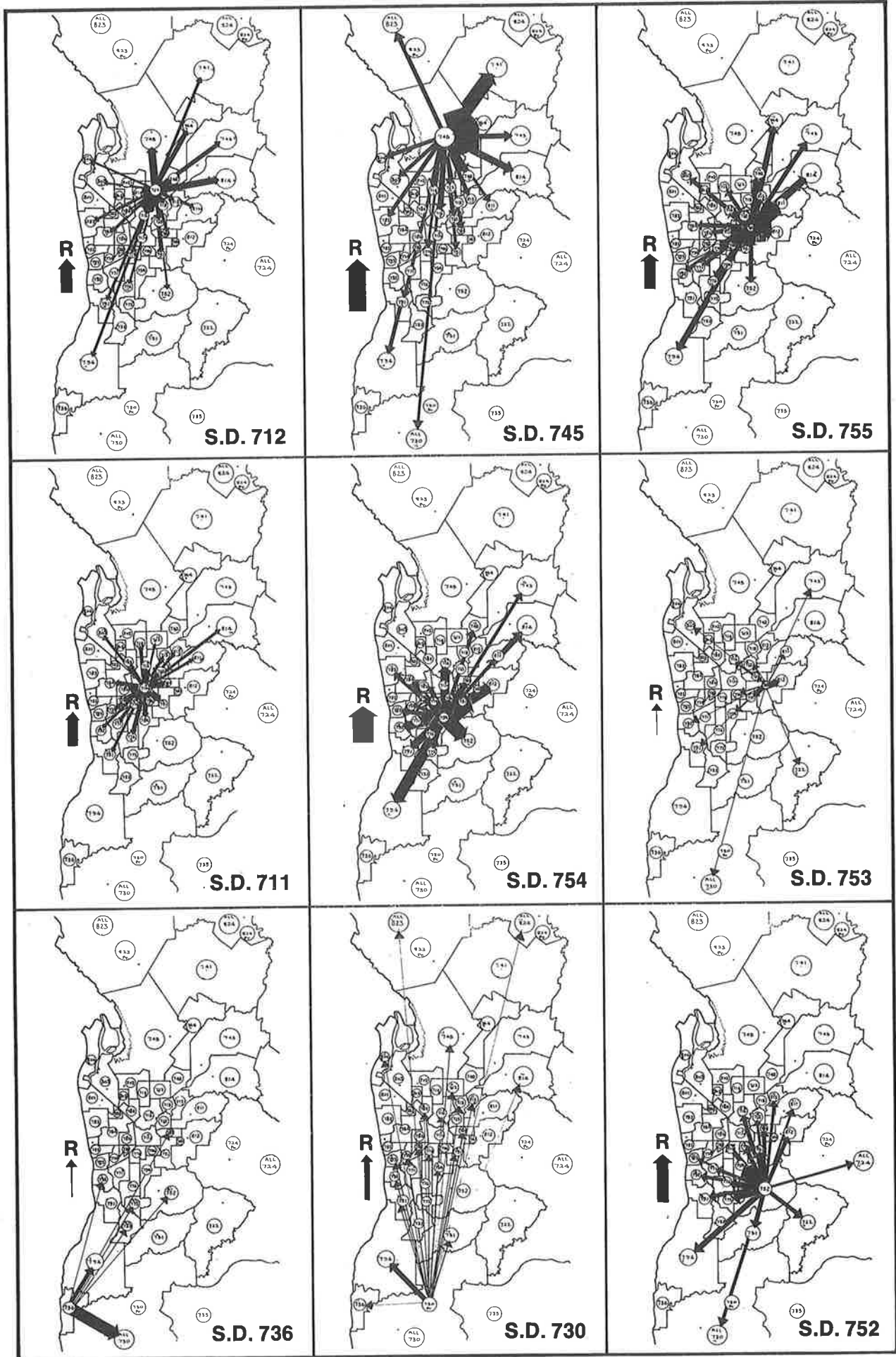

FIG. 5.2(2) Maps showing comparative spatial arrangement of outmoves.

from electoral subdivisions.

As part of the processing of data from the transfer matrix a separate diagram was compiled for each subdivision from a rank listing of flows. The subdivisional maps show only about seventy-five per cent of individual moves because beyond this point flows tend to be not only individually very small but so numerous as to confuse the map. Each of the major active links was represented by an arrow joining the origin to the destination subdivision. The width of the line was scaled to represent proportionately the number of movers utilizing the particular active link. It is not appropriate at this point to display the diagrams of all fifty origin areas. In later chapters when distance and direction are considered in some detail more use will be made of them. Nevertheless some useful ideas do emerge from an examination at this stage of a representative selection of outflow diagrams.

The nine maps displayed as a composite (see accompanying Figure 5.2) have been selected to represent two different but associated distributions. Firstly, the nine classes shown in the cross classification of rates of net migration and population turnover (see Table 4.4. and Fig. 4.6) have been represented by one subdivision from each. Membership of the nine classes is numerically very uneven ranging from as many as ten, to as few as two. Therefore representation is far from proportionate although the range of values is covered. Secondly, it was desired to cover a spatially representative selection of areas from the Adelaide Statistical Division. This task was made the easier by the fact,

demonstrated already (section 4.3) that the population movement indices are correlated with distance from the city centre, ensuring that a reasonably wide spatial coverage would emerge from a selection based on the indices alone. Therefore the simple procedure was followed of taking from Table 4.4 the first subdivision listed in each class, except in two cases where the second and third respectively were taken to improve consistency of population sizes or spacing of example areas.

The aim therefore in discussing this particular selection of nine subdivisions is to provide a preliminary view of general features of the geographic distribution of migration flows and volumes within the Adelaide Statistical Division according to relative scores on population movement indices and geographic location. The preliminary views, which will be taken up again in later sections, are discussed below in two sections under the respective headings of (a) volume and (b) direction.

(a) Volume

By far the largest single flow shown in Figure 5.2 occurs in the outer suburban area between S.D.s 745 and 744 where it is overwhelmingly dominant. By contrast no particular flow is outstandingly dominant in the middle suburbs, but rather there are several flows of similar volume with one a little bigger than the rest from each origin. The middle suburbs are represented by S.D.s 755 (Norwood), 754 (Mitcham) and 712 (Florey West). The central S.D. 711 (Adelaide) displays even less variability among its top six flows. It is clear that from every subdivision the

largest out-flows are to immediately adjacent areas.

The magnitude of rural destined flows (marked 'R' on the map) calls for some passing reference. In most subdivisions the combined outflow to areas of the state beyond the Adelaide Statistical Division is roughly of the same order as the largest single flow to a destination within the Division.

A clear impression given by the maps is that from any given origin there is a distinct fall-off in the number of movers with increasing distance from the origin. This is true regardless of either the volume of moves or the size of the area from which they emanate. This has been observed in many studies in a wide variety of situations (see Hägerstrand 1957, p.112). One explanation (Stouffer, 1940) relies on differences in the density of intervening residential opportunities in the territories to be penetrated by the migrant. In the present case the rate at which flows are absorbed by the urban territories over which they pass varies according to the position of the origin area. For example at least seventy-five per cent of the outmigration from the central area (S.D.711) goes no further than the middle suburbs (about 10 Km radius). The situation differs markedly for outer origin areas such as S.D.s 730 and 745. Apart from the one or two dominant flows which go to the nearest neighbouring subdivision, there are many medium and small volume flows which stretch out across the city - in some cases right to the other side. Most of the urban area, to a distance of at least 30 Km from the origin, is involved in absorbing the main seventy-five per cent of out-migrants from

outer subdivisions. Such territories are typically the largest in the city so that moves originating in them must be longer than elsewhere even before they cross the boundary. The first column in Table 5.2 reveals that the outer origin areas have high proportions of internal moves. Associated with this is the fact that moves from outer areas are more attenuated than those from other parts of the city.

Some middle suburbs display an interesting phenomenon in the morphology of the receptor area of their migrants. On the side nearest the C.B.D. flows appear foreshortened, few moves pass beyond it but many pass either side of it. There remains therefore a sort of shadow on the far side of the C.B.D. suggesting that it has acted as a barrier to movement. This is reminiscent of the "trade shadow" concept employed in marketing studies (for example, Smailes, 1969). Examples here are S.D.s 755 and 754, where movement is predominantly along an axis at right angles to the direction of the C.B.D., and S.D.s 752, 753 and perhaps 712.

(b) Direction

Reference has been made already to the fact that moves from certain middle suburbs display a "directional bias" (Adams, 1969) so that movement tends to take place concentrically across suburbs rather than sectorially away from or toward the C.B.D. as is observed in inner and outer areas respectively. Moves from the city centre (S.D.711) tend to occur in roughly even proportions in almost all directions whereas those from origins nearer the urban

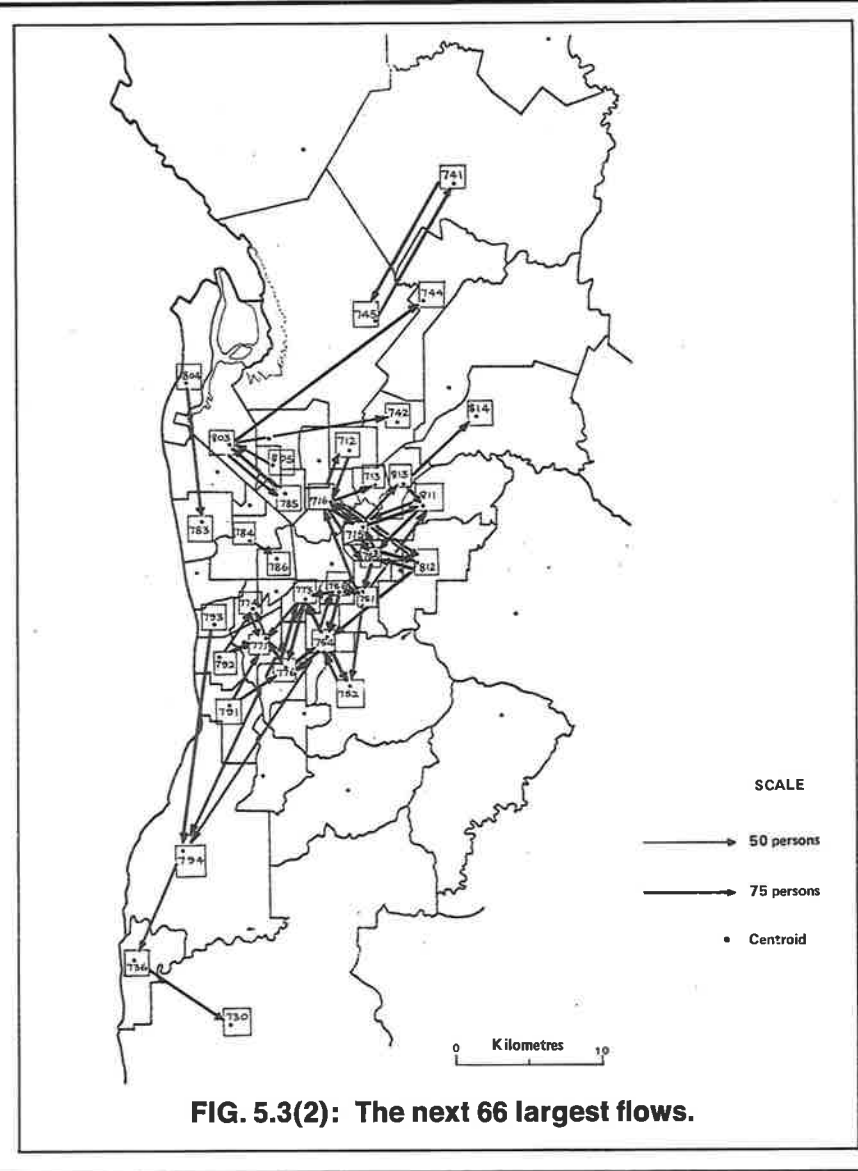
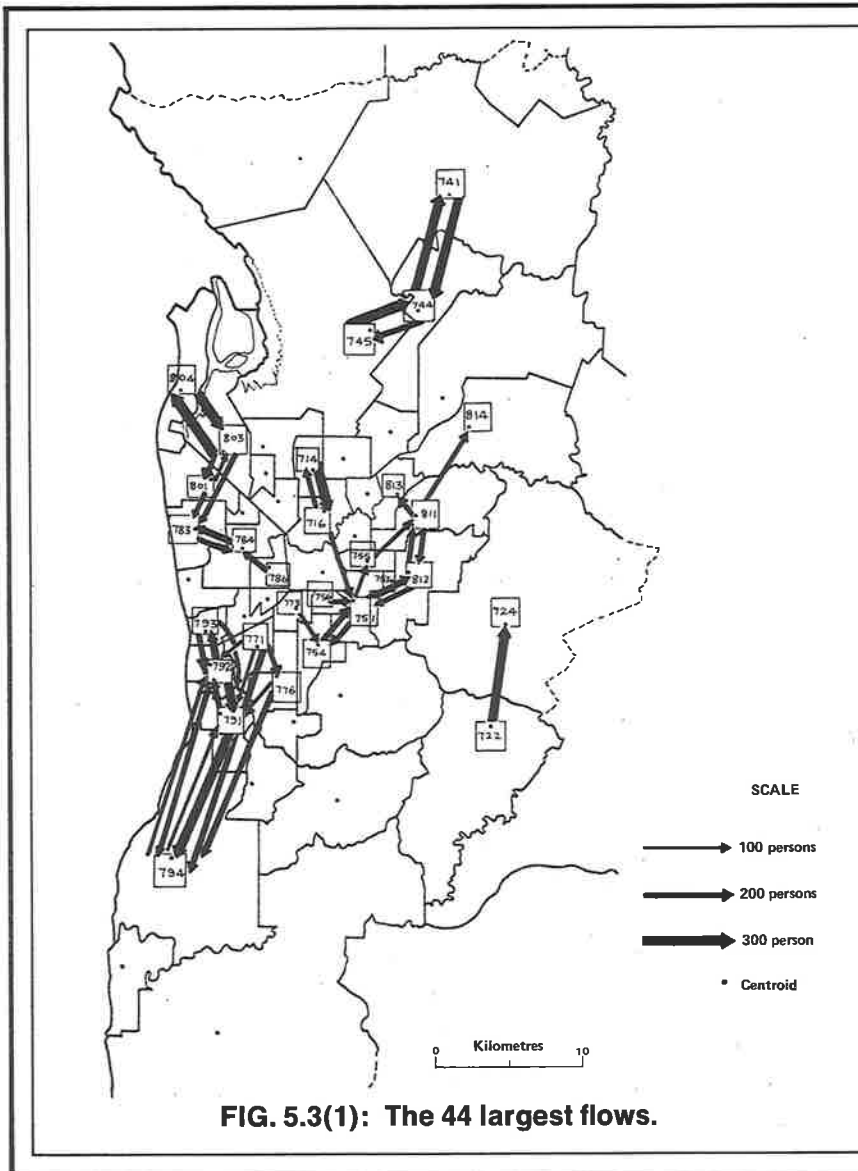

FIG. 5.3: The largest 110 intra-urban flows of electors between subdivisions, Adelaide Statistical Division.

Source: Data for period 12 March 1970 to 11 June 1971 supplied by State Electoral Dept., Adelaide.

periphery (see S.D.s 730 and 745) are concentrated into a narrowly oriented beam, properties which must result in part from the geometry of the system.

In final reference to Figure 5.2 attention must be drawn to the frequency with which S.D.794 (Mawson) appears as a destination. It did in fact record the greatest aggregated inflow of all subdivisions.

5.2.3 Largest flows

Further discussion of the distribution of intra-urban migrants will be concentrated on the 110 flows (5.16%) ranked highest among the 2,133 active links in the Adelaide Statistical Division. Between them they carry 28.58 per cent of all individual moves and are shown diagrammatically (see Figure 5.3/1 and Figure 5.3/2) using arrows of thickness proportional to the number of electors who transfer.

The first of the two maps shows only the 44 largest flows (2%) all of which carried 99 or more persons accounting for 17½ per cent of all moves. There are four distinct and separate systems which between them cover most of the city and, in addition, there is to the east an isolated single flow. Except the latter, these will be discussed collectively and then individually.

A prominent feature already discussed in section 5.2.1 is the high proportion of links which represent a mutual exchange of migrants. Among the twenty-eight subdivisions involved with links at the level shown on the map are eighteen sharing reciprocal flows.

It is interesting to note the sectorial nature of the clusters of subdivisions. Most prominent is that in the south-west focusing strongly toward S.D. 794 (Mawson). A north-western sector with S.D. 786 (Thebarton) at the inner city end has S.D. 804 (Semaphore) at the outer extremity. The cluster of flows involving S.D.s 741, 744 and 745 in the Salisbury-Elizabeth area can hardly be described as sectorially oriented. It is rather a special case of a self-contained system, a situation which probably arises from two physical factors. The Elizabeth area is separated from the contiguous Adelaide suburbs by a greenbelt. Furthermore a large proportion of the housing is government provided (see map Fig. A21) which enables relatively easy movement between alternative rental and/or purchase accommodation at moderate prices. The remaining system is the most attenuated with three separate paths focusing on S.D. 751 (Bragg). Only the section of the system northeast of Bragg reaching out to S.D. 814 (Highbury) can be considered as sectorial.

A considerable proportion of the movement circulates around what may be termed 'key' areas. Subdivisions which fulfil this function are 783 (Henley Beach) and 803 (Price) in the north-west; in the south the triangle of 792 (Glenelg), 791 (Brighton) and 794 (Mawson); in the eastern system 751 (Bragg), 811 (Coles) 812 (Davenport) and in the north 744 (Playford). The fact that these key areas are of roughly equal spacing (about 10 Km) around the outer middle suburbs suggests that perhaps they represent an upper level in a natural hierarchy of "communities of interest". In each case the key subdivision has a combined in and out flow of

about one thousand electors. There is scope, it is suggested, for much fuller investigation, even with the data already on hand, of the structure and operation of these groupings.

Two omissions from the map (Fig. 5.3/1) call for brief comment. Firstly, despite the strong outmigration and high turnover from the inner city (S.D.711) no single flow was large enough to appear at this level of analysis. This resulted from the fairly uniform spread of movement among a considerable number of destinations (see Fig. 5.2). Secondly, high rates of net migration were recorded in the north-eastern subdivisions of Modbury (743) and Highbury (814) but only one flow was large enough to appear on this map suggesting that in-migrants to the area came from a widely scattered variety of sources.

Sixty-six flows of the next lower order (between 67 and 99 persons per active link) are shown in Figure 5.3/2). It displays an additional 2.6 per cent of active links and about 11 per cent of all out-migrations. Even at this level no flows are shown involving the central city and only one to the north-eastern suburbs. The four basic "activity areas" of the first map appear again and there is a persistence of the pattern of reciprocity of many flows. The most outstanding feature is the linkage between systems or activity areas so that the original four now may be seen as two. The first linkage involves the southern and eastern suburbs while the second joins the north-west and northern suburbs.

It was shown in the previous chapter that a group of six

contiguous subdivisions in the south-western suburbs formed an axis of maximum outflow (see Fig. 4.10/2). The same area stretching from S.D. 792 (Glenelg) to S.D.751 (Bragg), appeared in Figure 5.3/1 as parts of two separate systems. It is shown in Figure 5.3/2 as a single, closely-integrated system joined through the mutual linkage of two outlier subdivisions in each of the higher-order systems. The linking of the north-western and northern systems occurs at a lower order between the two key subdivisions, 803 (Price) and 744 (Playford).

The other outstanding new feature is the appearance of an area of intense movement activity of a moderate order in the inner north-eastern suburbs. This network centres around a triangle of key subdivisions, namely, 716 (Torrens), 715 (St. Peters), and 755 (Norwood). The following points constitute a case for considering S.D. 716 (Torrens) as the 'pivot' for the entire city.

- (a) It contains the Population Centre of Gravity, P.C.G. (see section 4.6.2)
- (b) It has the highest absolute number of out-transfers (see Table 5.1)
- (c) It has the second highest absolute number of in-transfers (see Table 5.1)
- (d) It ranks fifth on the rate of annual population turnover (see Table 4.3). (A lower score on internal moves lowers the rate of population turnover).

Its late appearance on the map of high-order flows is due to its

wide range of mainly moderate flows which is what makes its position one of importance in the total city movement and social structure.

Finally it should be pointed out that although in the first map there was little evidence of movement toward the city centre there is rather more at the lower level, in the second map, where some is directed to inner ring subdivisions (786, 773, 756, 715 and 716).

The rapidly growing south-western subdivision 794 (Mawson) is shown to draw smaller numbers of migrants from the more distant areas nearer the city centre.

The main feature of Figure 5.3 may be summarized as follows. The middle suburbs are confirmed as the areas where total movement is greatest. They are the "key areas" for intra-urban migration both as donors and receptors. In all areas the largest flows occur between adjacent subdivisions and there is almost always a reciprocal or counter flow of a similar size. Over the whole city the main thrusts of movement were outwards and concentrated in four main areas - strongly to the south-west and mildly to the north-west, north-east and north.

5.3 INTERNAL MOVES

So far discussion about movement has been based primarily upon the concept of change of address between electoral subdivisions. Passing reference has been made already (see 4.3.2) to some of the

TABLE 5.3

Internal Moves: Rank Size Distribution of Changes
of Address Within Electoral Subdivisions

Internal Changes of Address	Number of Subdivisions	Internal Changes of Address	Number of Subdivisions	Internal Changes of Address	Number of Subdivisions
2	2	117	1	321	1
7	1	136	1	346	1
10	1	163	2	364	1
11	1	168	1	370	1
15	1	170	1	406	1
20	1	180	1	419	1
39	1	192	2	422	1
43	1	212	1	435	1
46	1	231	1	446	1
56	1	254	1	477	1
61	1	269	1	542	1
74	2	271	1	550	1
75	2	272	1	654	1
86	1	277	2	717	1
101	1	278	1		

Total: 11 088 internal changes

Mean: $\frac{11\ 088}{50} = 221.8$ per subdivision

Source: Amendments List, State Electoral Dept., Adelaide.

problems arising from the great variation in the size of territory comprising these spatial units. As a result of this there is also considerable variation between subdivisions in the distance electors must move before becoming 'transfers' on the electoral roll. This irregularity can be overcome to some extent if it is known how many electors change address within each subdivision. A method of deriving this information from electoral rolls was explained in section 3.8.2.

Actual data on internal changes of address was used to generate for each subdivision an index of Population Turnover (see section 4.3.2 and Table 4.3).

The accompanying Table 5.3, which is a consolidation of data from Table 5.2, shows the rank size distribution of numbers of internal moves amongst subdivisions. This information shows that internal moves within the Adelaide Statistical Division comprise about twenty per cent of all moves (11,088 of 51,030 moves) with the mean per subdivision of 221.8 internal changes of address. Unfortunately such changes cannot logically be considered as occurring in aggregations, or flows between points, as the territories are too small. It is, therefore, difficult to generalize about the distance or direction of such transfers without having gathered and processed each of the transfers individually. Since this is such a formidable task, sufficient in itself for a separate study, the analysis in following chapters of distance and direction of movement makes only simple use of internal moves.

REFERENCES

- ADAMS, J.S. (1969) 'Directional Bias in Intra-urban Migration'. Economic Geography, vol. 45, no. 4, pp.302-323.
- CURSON, P.H. (1970) 'Polynesians and Residence in Auckland'. New Zealand Geographer, vol. 26, pp. 162-173.
- EVANS, K.M. (1962) Sociometry and Education. (2nd impression, 1966). Routledge and Kegan Paul, London.
- GIBSON, J.S. (1967) 'The Residential Pattern and Mobility of Dutch and Greek Migrants in the Adelaide Metropolitan Area'. Unpublished thesis, Dept. of Geography, University of Adelaide.
- HÄGERSTRAND, T. (1957) 'Migration and Area'. Lund Studies in Geography, Series B, no. 13, pp. 27-158.
- HOYT, H. (1939) 'The Pattern of Movement of Residential Rental Neighbourhoods'. Reprinted in Readings in Urban Geography. Edited by H.M. Mayer and C.F.Kohn, University of Chicago Press, Chicago, 1959, pp.499-510.
- MOORE, E.G. (1969b) 'The Nature of Intra-urban Migration and Some Relevant Research Strategies'. Proceedings of the Association of American Geographers, vol. 1, pp.113-116.
- MORENO, J.L. (1946) 'Sociogram and Sociomatrix'. Sociometry, vol. 9, pp. 348-349.
- MORENO, J.L. (1953) Who Shall Survive? Foundations of Sociometry, Group Psychotherapy and Sociodrama. Beacon House, New York.
- MORRILL, R.L. (1965b) 'Expansion of the Urban Fringe: A Simulation Experiment'. The Regional Science Association Papers, vol. 15, pp. 185-199.
- MORRILL, R.L. (1965c) 'The Negro Ghetto: Problems and Alternatives'. Geographical Review, vol. 55, pp. 339-361.
- RAVENSTEIN, E.G. (1885) 'The Laws of Migration'. Journal of the Royal Statistical Society, vol. 48, pp. 167-235.
- SIMMONS, J.W. (1968) 'Changing Residence in the City - A Review of Intra-urban Mobility'. Geographical Review, vol. 48, no. 4, pp. 622-651.

SMAILES, P.J. (1969) 'A Metropolitan Trade Shadow. The Case of Adelaide, South Australia'. Tijdschrift Voor Econ. En. Soc. Geog., vol. 50, no. 6, pp. 329-345.

STOUFFER, S.A. (1940) 'Intervening Opportunities: A Theory Relating Mobility and Distance'. American Sociological Review, vol. 5, pp.845-867.

DISTANCES OF OUTMOVEMENT

Distance is such an important factor that it needs more explicit study than it has received.

STOUFFER (1940, p.845)

OUTLINE

A distribution, both statistical and spatial, is prepared showing numbers of movers by distance, utilizing the data on number of movers per active link (Chapter 5) and the calculated distance between centroids (Chapter 4). The problem of deriving from aggregated data an expression of the distances moved within each subdivision is solved by treating the component census collectors districts as origin - destination cells and weighting them for the resident population of electors. From the combined distribution of distances, both internal and external moves, are derived mean distances moved for each subdivision and the whole study area.

A simple four-stage model is used to compare the distance distribution of transfers actually made with the geometry of the network of opportunities and the usage patterns under different population and mobility distributions. This confirms a strong behavioural preference for short moves. Finally, distance moved is compared briefly with a selection of other variables including size of the originating territory, rates of fall-off in transfers with distance from origin and with distance of origin from the city centre.

CHAPTER 6 DISTANCES OF OUTMOVEMENTCONTENTS

	Page
6.1 INTRODUCTION	186
6.2 THE DATA AND METHODS OF ANALYSIS OF DISTANCE MOVED	187
6.2.1 Between Subdivisions	187
6.2.2 Within Each Subdivision	188
6.2.2.1 Problem	188
6.2.2.2 Available information	190
6.2.2.3 Method for internal distance determination	192
6.3 DISTRIBUTION OF DISTANCE MOVED	195
6.3.1 All moves considered in aggregate: a model	196
6.3.2 Modelling results considered	199
6.3.3 Internal moves	200.1
6.4 DISTANCE MOVED COMPARED WITH OTHER VARIABLES	200.2
6.4.1 Size of S.D. and distance	200.4
6.4.2 Movement indices and distance	200.6
6.4.3 Rate of fall-off with distance of origin from C.B.D.	200.8
6.4.4 Ethnicity	200.9
6.4.5 Forced moves	200.10
6.5 SUMMARY	200.10
REFERENCES	200.12

CHAPTER 6 DISTANCES OF OUTMOVEMENT

LIST OF FIGURES

Figure	Page
6.1 Graph comparing percentage cumulative frequencies for distance moved in each of four stages of the distance-moved model	facing p.196
6.2 (Map) Mean distance of outmoves from each electoral subdivision	facing p.200
6.3 Distances moved by electors on residential transfer (1970-71)	facing p.199
(1) Mean number of moves per active link by distance moved	
(2) The four stages of the distance-moved model, showing the percentage of transfers against distance moved	
6.4 Distance of C.B.D. from each origin subdivision compared with	facing p.200.8
(1) rate of fall-off in number of moves with distance	
(2) mean distance moved	
6.5 Pearson correlation coefficients between mean distance moved and selected variables	on p.200.6

CHAPTER 6 DISTANCES OF OUTMOVEMENT

LIST OF TABLES

Table		Page
6.1	Transfers in ascending order of distance for each electoral subdivision in the Adelaide Statistical Division, 1970-71	separate fold-outs
6.1/A	Model, stage 1: The network Number of links by length of link a. internal b. active c. inactive	facing p.194
6.1/B	Model, stages 2 and 3: moves with simplifying assumptions Stage 2 - mean electors Stage 3 - all movers	facing p.194
6.1/C	Model, stage 4: actual transfers	facing p.194

CHAPTER 6 DISTANCES OF OUTMOVEMENT

"All evidence indicates the importance of distance from the mover's origin in differentiating housing alternatives. Most moves are short, within familiar territory..." (Simmons, 1968, in Berry and Horton, 1970, p.405).

"If we are to treat adequately the role of space, one important place to begin is with the function of distance in the description and explanation of migration distances" (Morrill, 1963, p.75).

6.1 INTRODUCTION

The aim of this chapter is to present a description and analysis of the distances covered by those electors who changed place of residence within the Adelaide Statistical Division between March, 1970 and June, 1971. For this purpose reference to particular destinations in the kind of detail discussed in Chapter 5 is unnecessary. The main material for consideration is a matrix showing for each subdivision the number of electors who moved various distances. From this are derived, separately for each origin and for the whole study area, mean values for distances travelled. The data are then reprocessed treating the Adelaide Statistical Division as a single spatial unit in order to discover the total distribution of individual distances moved within the urban system as a whole.

Moves within subdivisions are a considerable part of total movement and necessarily occur over relatively short distances. So far, however, discussion in this thesis has been concerned with transfers between electoral subdivisions. Although for internal transfers no direct measure was available of the distances over which movement occurred, a method was developed in this study for estimating both the distances between the points in the internal network of potential

destinations and of actual transfers weighted according to the distributions of existing populations. This chapter discusses some of the problems involved in trying to deduce meaningful distance figures from aggregations of internal transfers. Finally comparison is made between variation of distance moved and distance of origin from the C.B.D., size of origin unit and rate of fall-off in the number of movers with distance, and with other selected variables.

That a measure of distance moved is available for consideration in the present context is due to a basic generalizing assumption which has been discussed already (see section 4.6.1). The assumption is that for any group of migrants sharing the same origin and destination areas the movements on average begin and end at the central points (centroids) of already established populations within the respective areas. The determination of centroids for the fifty electoral subdivisions and the distances between them was outlined in section 4.5.2. It is this data, and that on flow volumes presented in Chapter 5, which together form the basis of the present chapter. The estimate made of distances covered by transfers within subdivisions was derived in a manner similar to that employed for the inter-subdivisional movement. This was based upon the network within subdivisions of the mid-points of the component collectors' districts.

6.2 THE DATA AND METHODS OF ANALYSIS OF DISTANCE MOVED

6.2.1 Between Subdivision

The calculated distances between the network of centroids is set out in a fifty by fifty matrix (see Appendix E). The numbers of

electors transferring between these points are shown in Table 5.1 and are the basis of the analyses already discussed in Chapter 5. These two sets of information were brought together in the following manner to calculate mean distances for aggregations of outmigrants.

(a) For each subdivision as origin:

- (1) The number of persons moving to each other S.D. is known (see Table 5.1)
- (ii) The distance (Km) between centroids is known (see Appendix E)
- (iii) For each active link multiply (i) by (ii) to obtain a 'Kilometre-persons' product
- (iv) Add together all such products from the one origin
- (v) Divide the total 'kilometre-persons' by the total number of outmigrants. The result is a mean distance per outmovement from the given origin.

(b) For the whole Adelaide Statistical Division:

- (i) Sum all the 'kilometre-person' totals for the fifty subdivisions in the A.S.D.
- (ii) Divide the grand total from (i) by the grand total of outmigrants

6.2.2 Within Each Subdivision

6.2.2.1 Problem:

In contrast to the relative ease of deriving a general expression of the distances moved between subdivisions anything similar for internal moves is much less easily determined.

Although it was known from the rolls that 11,088 electors registered a change of address within their subdivision (representing 21.7 per cent of all transfers during the study period) there was no convenient means of deriving from the rolls the distance moved because the aggregated statements on internal moves did not show precise places of origin or destination. Distances could have been obtained by measurement on the map showing the actual house addresses involved in each transfer within an electoral subdivision but this was impractical because of the large number of moves. Nothing better was possible, therefore, than making systematic estimates of the distance travelled internally. Nevertheless, it is a necessity in this analysis to be able to consider the whole distance distribution of all moves, taking account if required of the fact that some residential transfers occur within and others between the spatial data cells. If, for this purpose the two measures are separately derived they should be based on comparable assumptions and of similar accuracy so that they may be considered together.

The relative importance of the intra-urban moves within data cells (in this case 21.7 per cent) may be compared with other studies. For example, several American studies (see Simmons, 1968, who quotes Green, 1934-42; Caplow, 1949; and Albig, 1933) produce similar results with their approximate average of twenty-five per cent for movement within urban census tracts. Direct comparison of the Adelaide results is not possible because the size of American census tracts is not indicated nor the time-span of movement. Nevertheless the total trend is undoubtedly in keeping with the broad generalization expressed by Johnston (1971, p.317) that "the great

weight of available evidence indicates that short-distance moves predominate within cities".

More precise estimates of the aggregated distances moved internally were obtained in the present case by methods essentially similar to those already described in the determination of the position of and distances between centroids. In this 'internal' case, work was of course at a scale comparatively smaller and at a lower order of the system. The component collectors' districts within subdivisions were represented by their centre points, and themselves considered as the network of possible origins and destinations. The following two expressions of distance were calculated for each subdivision, in the manner shown below; unweighted-network mean distance, and population-weighted mean distance.

6.2.2.2 Available information:

The only information about internal moves recorded from the electoral rolls was the aggregated number of moves for each subdivision. In order to obtain an objective estimate of the distances thus moved the following two components were used: firstly, an indication of the size and distribution of the resident population was obtained for the constituent Census Collectors' Districts; secondly, the location of the central point of each C.D. had been described already with coordinates on a reference grid (Chapter 4, p.150). These two components had been used to determine the population centroid for each electoral subdivision (section 4.6). In order that movements between subdivisions could be considered as occurring along vectors with length and direction it was necessary to make the simplifying assumption (p.161) that, on average, migrations

between subdivisions begin and end at the population centroids. The use of a similar set of simplifying assumptions about aggregated internal moves enables an estimate to be made of their collective characteristics. Moves within subdivisions are merely at a micro-scale compared with those between subdivisions and may be considered as occurring between the component Census Collectors' Districts. The following assumptions enable a calculation of internal distance moved: if the total number of moves made within a subdivision is known then they will have originated from the component C.Ds. in numbers directly proportional to their respective shares of the total subdivisional population of electors; the outmoves from each sub-area will be dispersed to all component C.Ds in proportion to the population already residing there. Underlying both the above is another assumption, namely, that a uniform mobility rate obtains throughout a given subdivision. Finally, if the assumption is made that moves internal to subdivisions begin and end at the mid-points of their component C.Ds then it is possible to attribute a distance to each vector in the network of possible destinations.

In Chapter 4 (section 4.6.2) it was explained that the location of a centroid was calculated for each electoral subdivision using the following formula and components:

$$\text{Co-ordinate 'X' of centroid of the subdivision} = \frac{\sum p_j^i x}{P}$$

where p = population of each component C.D. in turn (i to j)

x = the x co-ordinate of the C.D. mid-point

P = total population of the subdivision (sum of all 'p' values)

The 'Y' co-ordinate is found by repeating the procedure with the 'y' co-ordinates of the C.D. mid-points.

6.2.2.3 Method for internal distance determination

The same data elements were used in the present context to calculate the distances, map and real, between the C.Ds within each electoral subdivision (the method of calculation is explained in Section 4.6.2, p.151). As described above, electors moving within subdivisions are likely to be influenced by existing population distributions because, other than new dwelling construction, residential vacancies are likely to be in proportion to the size of the population. The following formula was based on such a simplifying assumption and was used to obtain an estimate of the mean distance moved internally when population distribution was taken into account.

$$\begin{aligned}
 D &= \frac{\frac{p^1}{p} (p^1 d^{1.1} + p^2 d^{1.2} + \dots + p^n d^{1.n}) + \frac{p^2}{p} (p^1 d^{2.1} + p^2 d^{2.2} + \dots + p^n d^{2.n}) + \dots}{P} \\
 &\quad + \frac{\frac{p^n}{p} (p^1 d^{n.1} + p^2 d^{n.2} + \dots + p^n d^{n.n})}{P} \\
 &= \frac{p^1 (p^1 d^{1.1} + p^2 d^{1.2} + \dots + p^n d^{1.n}) + p^2 (p^1 d^{2.1} + p^2 d^{2.2} + \dots + p^n d^{2.n}) + \dots}{p^2} \\
 &\quad + \frac{p^n (p^1 d^{n.1} + p^2 d^{n.2} + \dots + p^n d^{n.n})}{p^2}
 \end{aligned}$$

where D is the population-weighted mean distance between C.Ds within a given electoral subdivision (S.D.)

p is the population of each individual collectors' district (C.D.)

P is the sum of the populations of all C.Ds in the S.D.

d is the distance between each pair of C.Ds in the network.

If the network of C.D. linkages is analysed without regard for population distribution an unweighted mean distance can be calculated using the following formula:

$$UD = \frac{\sum d^1}{n^2}$$

where UD is the unweighted-network mean distance between C.Ds

d is the distance between each point in the network and each other in turn from point 1 to point n including the self-to-self (zero distance)

n is the total number of points in the network.

Summary indices of the same kind were obtained for the whole Adelaide Statistical Division by using the following formulae:

(a) Adelaide unweighted-network mean

$$A_{uw} = \frac{\sum_{K=1}^N \sum_{i=1}^{n_K} \sum_{j=1}^{n_K} dij}{\sum_{K=1}^N n_K^2}$$

where dij is the distance between C.D. _i and C.D. _j

n_K is the number of C.Ds in the subdivision K

N is the total number of S.Ds in the Adelaide Statistical Division

(b) Adelaide population-weighted mean

$$A_{WT} = \frac{\sum_{K=1}^N \left[\sum_{i=1}^{n_K} \left(\sum_{j=1}^{n_K} dij p_j \right) \right] p_i}{\sum_{K=1}^N p_K^2}$$

where d_{ij}, n_k, N are as already defined above

P_k is the total population of subdivision k

p_i, p_j denote populations of C.D. i and C.D. j
respectively

The results of applying all the procedures described above are set out in the accompanying tables (Table 6.1/A, B and C). These show for each subdivision and the whole A.S.D. a series of factors arrayed across single kilometre classes listed in ascending order of distance. The selected factors are a graded sequence of simplifying assumptions arranged to test whether there is a genuine aggregate behavioural preference for shorter distance movement. The assumptions and their application to the data as a modelling situation are discussed in the next section (6.3).

Table 6.1/A sets out the distance characteristics of the entire network itself, within electoral subdivisions and between subdivision centroids. Table 6.1/B shows the number of moves made under different sets of simplifying assumptions. Table 6.1/C shows the number of actual transfers observed. At the foot of each table is the percentage cumulative frequency used in the graphs of Figure 6.1.

The mean length of all individual moves was 8.2Km, comprising a mean of only 2.5Km for moves internal to subdivisions and 9.8Km for moves between subdivisions. These results may be compared with the mean length of the inter-subdivisional links themselves, of 15.9Km, thereby indicating mover preference for shorter transfers. Even when allowance is made to the network for differences in the distribution of the resident population (see Section 6.3.1) the mean is 14.7Km and when modified for differences in mobility rates the mean is 14.4Km.

The mean length of active links (n=2,133) is 14.6Km in contrast with that of inactive links (n=317), 24.6Km.

These results are obviously in general agreement with the findings of many studies that "most moves are short, within familiar territory" (Simmons, 1968, p.640). However, as may be expected the actual figures differ between studies conducted in different places and times. For example, residential transfers between 1962 and 1967 in Seattle were examined by Boyce (1969, pp23-26). The results compare as follows: the mean length of intra-city moves is 4.8Km in Seattle and 8.2Km in Adelaide; moves shorter than 0.8Km comprise 16 per cent in Seattle and 10 per cent in Adelaide. The prominence in Seattle of Negro ghetto systems with their short moves (mean 2Km) may account for the difference. In 1965 a sample of households in Christchurch, New Zealand, moved a mean distance of almost 4Km (Clark, 1970, p.52). However, because each of these studies was differently based, both spatially and methodologically, little comparative comment is justified.

6.3 DISTRIBUTION OF DISTANCE MOVED

By means of the procedures and formulae outlined above a separate estimate was obtained for each electoral subdivision in the Adelaide Statistical Division of the distances over which electors had moved when changing place of residence within the subdivision. The results are incorporated in Table 6.1/C along with, but differentiated from, the inter-subdivisional movements. Discussion of the results will be in three sections; firstly, all moves considered in aggregate: a model (6.3.1), secondly, modelling results (6.3.2) and thirdly,

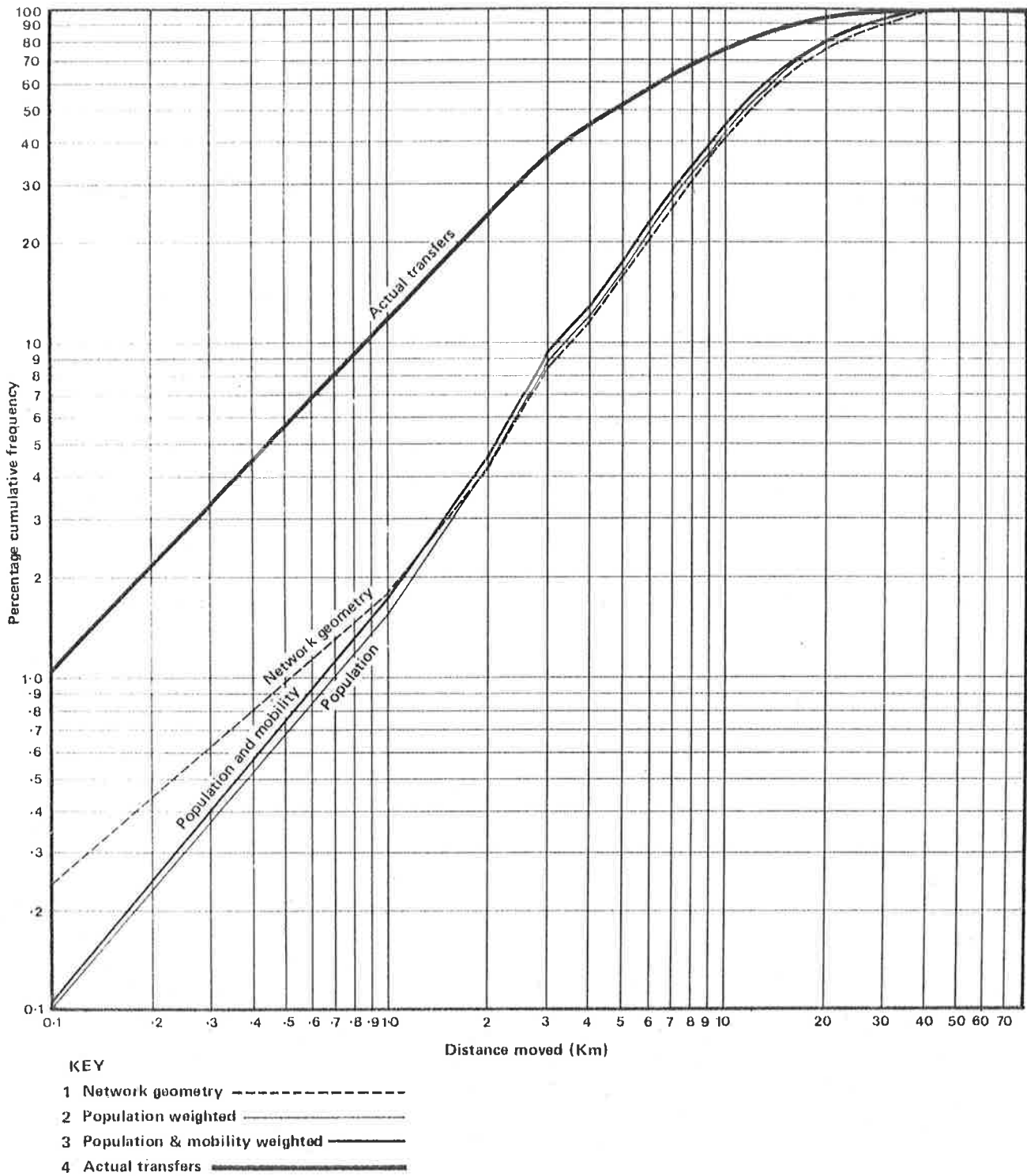

FIG. 6.1: Graph comparing percentage cumulative frequencies for distance moved in each of four stages of the distance-moved model.

internal moves (6.3.3).

6.3.1 All Moves Considered In Aggregate: A Model

These results suggest a strong tendency for movers to prefer short distance transfers. However, it is inadvisable to draw this conclusion too hastily - at least until separate allowance has been made for whatever inherent predisposition the geometry of the network itself has toward shorter linkage opportunities. To this end the following objective comparison was achieved in four stages based on a sequence of graded assumptions without separate regard for either internal or external moves. The comparison was between the range of distance opportunities provided by the geometry of the network of the fifty electoral subdivisions and the actual movements undertaken by electors when changing residence. In each of the four cases, distances were accumulated into single kilometre classes in ascending order and expressed as percentage cumulative frequency (Table 6.1/A,B,C). These cumulations are presented individually on a single graticule as four graphed curves (see Fig. 6.1) and discussed separately below.

Curve (1) represents the network geometry, either taken alone or with equal usage of all linkages (same curve in both cases). The only aspect of reality admitted to the model at this stage is the unmodified distances between all points in the network. It therefore incorporates distances between centroids and an internal unweighted-network mean for each subdivision. The "equal usage" case represented by this curve would result if all subdivisions generated a uniform amount of movement from uniformly dispersed populations so that all

opportunities were uniformly utilized (or not utilized).

Curve (2) represents the network geometry modified by the number of electors residing in each subdivision. In this case the distance network model has been relaxed to take account of one more aspect of reality, namely the known distribution of different population numbers in each subdivision. However, it assumes that all areas have the same mobility rate and therefore that mover volumes differ merely in direct proportion to the population-size of the origin area and that movers are uniformly dispersed to all available destinations.

The results show that Adelaide's population is residentially so distributed within the study area as to provide a slight predisposition for aggregated movement to favour the shorter transfers. For example, the network has 50 per cent of the links shorter than 12.5 kilometres, whereas curve (2) shows 52.7 per cent of moves would occur over this range under the influence of the actual population distribution. The distance-shortening influence of the population distribution is apparently greatest in the middle distances, between about 12 and 35 kilometres, where the curve separation is greatest.

Curve (3) represents the network geometry modified, not only by the number of resident electors, but also by the observed numbers from each subdivision who change residence. This modification of the model incorporates one additional aspect over curve (2) by admitting that different populations display different propensities to transfer residence. The actual observed number of movers from

each subdivision has been applied but with the simplifying assumption that all possible destinations have been equally used. The resulting curve (3), when compared with curve (2), shows a very small additional propensity for differences in the spatial arrangement of mobility rates to increase the preference already noted for shorter distance transfers. For example, the curve (2) showed about 52.7 per cent of moves would be of less than 12.5 kilometres whereas curve (3) shows that differences in mobility rates would increase the proportion over this same distance to 54.8 per cent. However, it is apparent that the distance-shortening influence of differences in mobility rates is almost uniform right across the total range of distances, the two curves being almost parallel.

Curve (4) represents 'reality' - where electors in each subdivision, who were known to have moved to a particular destination, have been aggregated according to which distance link in the network they used. Therefore, the actual personal behavioural choices of movers have been incorporated into this stage of the model. The only remaining assumptions about mover behaviour are those fundamental to this entire study and discussed earlier.

The result shown in curve (4) displays a very pronounced shift towards distances much shorter than those in curve (3). For example, curve (3) showed 54.8 per cent of moves were shorter than 12.5 kilometres whereas in actual fact 81.9 per cent of all moves occurred in that distance range. Given the systematic and controlled relaxation of simplifying assumptions in this set of models the graph must be taken as convincing evidence of a strong behavioural preference for those transferring residence to utilize the short-

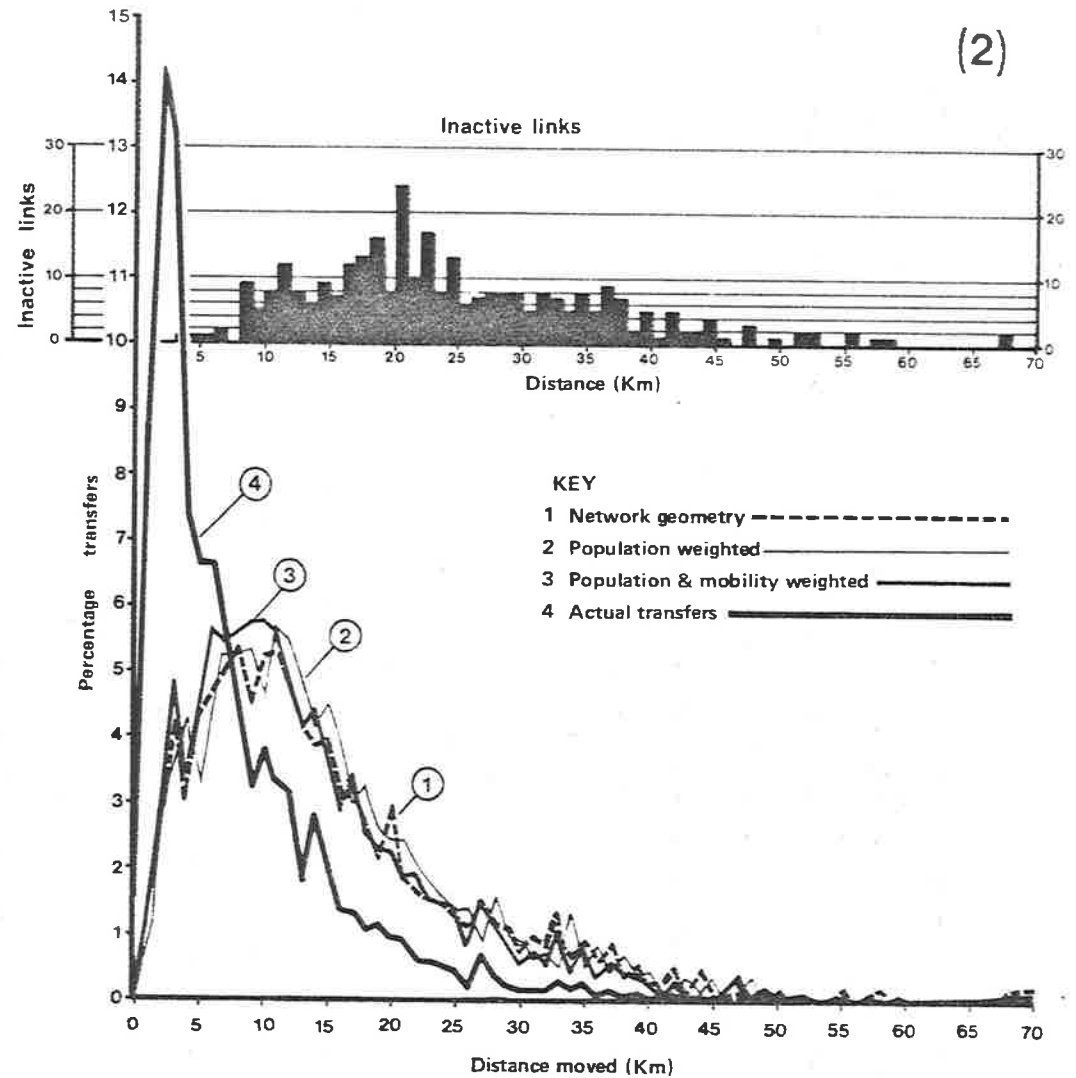
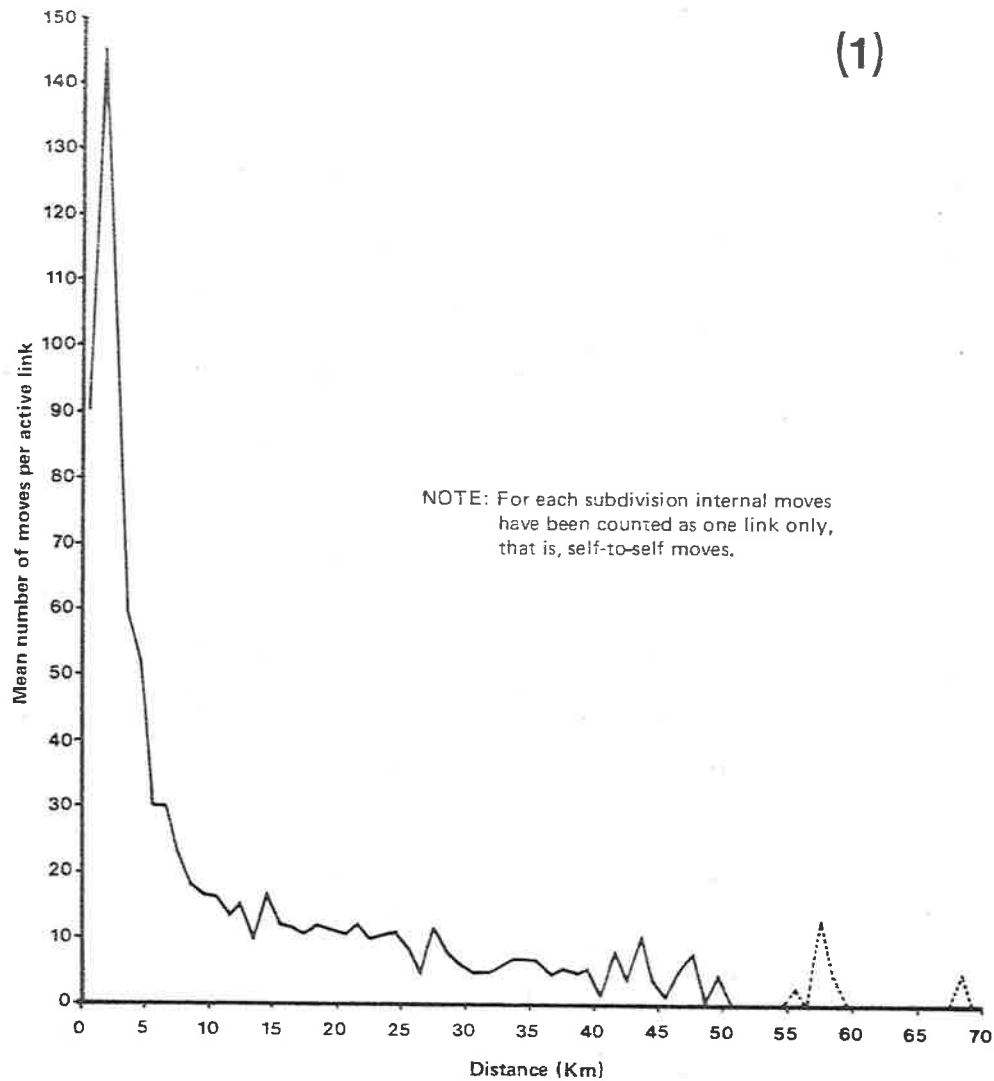

FIG. 6.3: Distances moved by electors on residential transfer (1970-71), (1) Mean number of moves per active link by distance moved, (2) The four stages of the distance-moved model, showing the percentage of transfers against distance moved.

distance opportunities within the Adelaide Statistical Division. This suggests that more people use the shorter links in the network of opportunities than is the case with the longer links. This is made very apparent in the graph (Fig. 6.3/1) showing the number of movers, including internals, per active link by distance actually moved. In contrast to the heavy usage of the shortest links is the fairly steady decline in usage with increasing length of linkage. Notable is the fact that the very shortest links (under 1Km) carry fewer transfers than the next longer class. This is discussed in greater detail later (section 6.4).

6.3.2 Modelling Results Considered

An interesting, and perhaps puzzling, feature of curves 1, 2, and 3 in Figure 6.1 is the way in which for distances below two kilometres curve 1 is further to the left and thus "out of sequence" with the rest of the graph. Quite simply, the graph shows that the existing population distribution (curve 2) and mobility rates (curve 3) favour slightly longer moves, in the range below two kilometres, than does the geometry of the network (Curve 1). It is likely that this slight bias arises from the following combination of facts.

Although the subdivisions with the shortest links are those with the smallest areas or territories, the number of such territories is numerically small and they generally do not have the largest populations. They tend, therefore, to provide overall rather less movers for the very shortest links. In this way, population size and mobility rates represented by curves 2 and 3 respectively, seem to weight slightly against usage of the shortest links on a scale commensurate with the

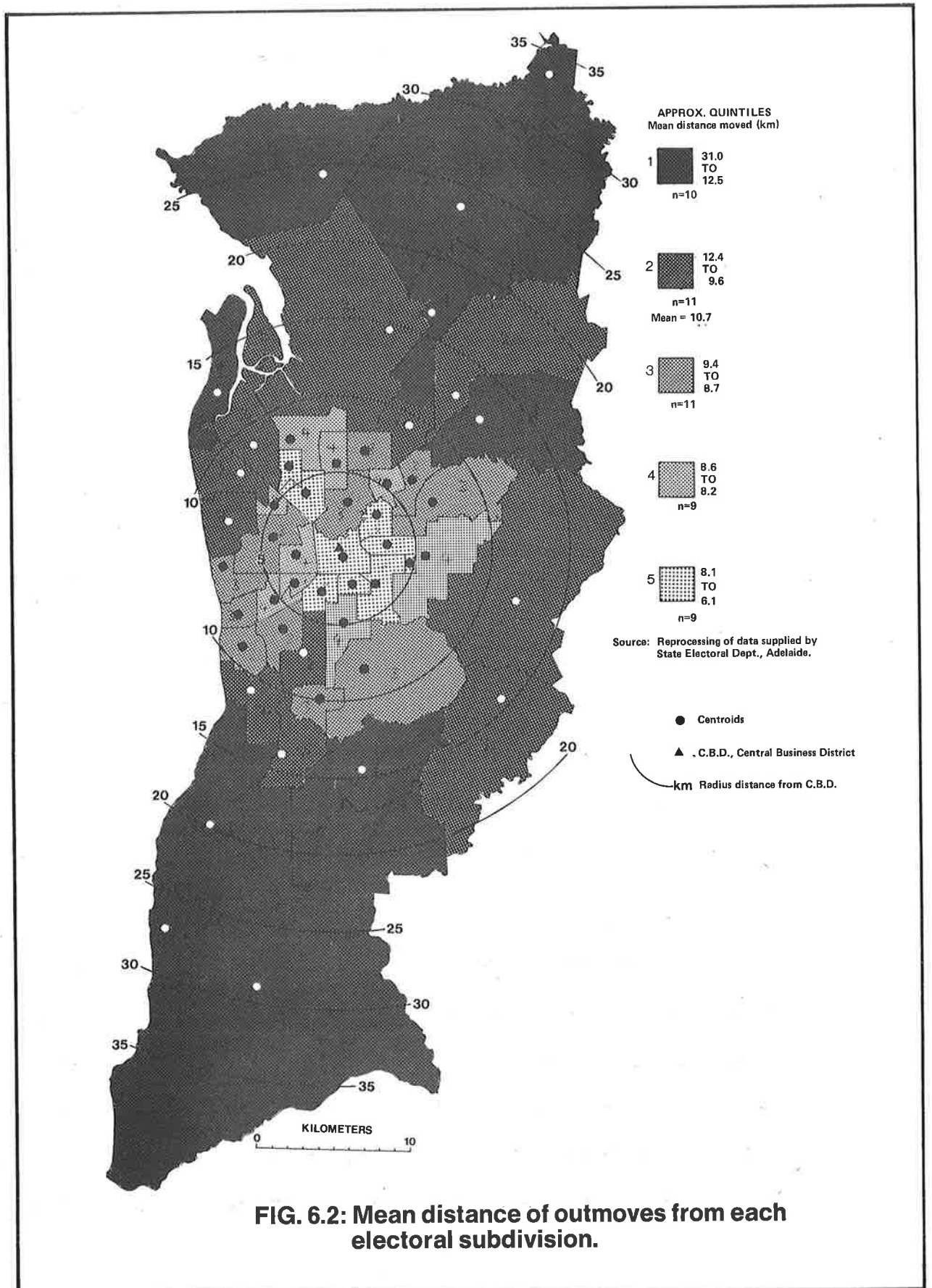

FIG. 6.2: Mean distance of outmoves from each electoral subdivision.

Source: Computations based on data supplied by State Electoral Dept., Adelaide.

actual availability of short links in the total network, as represented by curve 1. This is to suggest that the relative significance of the links shorter than two kilometres is slightly reduced by the actual distribution in the urban area of the population and its rates of turnover. Correlation coefficients discussed later indicate the possibility that this could be allied to the size of the spatial cells.

In view of the above discussion it is all the more noteworthy that actual transfers (curve 4) show a behavioural preference for shorter moves so strong as to completely obliterate the slight reverse trend just described.

Each stage of the four stage model is summarized in a profile enabling comparison of the relative shift across the distance range (Fig. 6.3/2). The graph shows separately for each curve the percentage of all movers utilizing each distance class. In addition it shows the actual number of links left inactive which may be compared with the number of opportunities in the distance class in the entire network. The inactive links are numerically greatest in the middle distance range but are proportionately greatest in the longer distances.

The spatial distribution of all mean distances of outmovement (excluding internal transfers) is shown in the accompanying map (Fig 6.2). Two features of particular interest arise from an inspection of the map. Firstly, there is a spatial gradation in the mean distances moved from subdivisions with the lowest values near the C.B.D. and highest at the urban periphery ($r = 0.94$, highly significant, 48df). This matter, and its relation to area of subdivisions

is discussed at greater length in the next section (6.4.1). Secondly, a few subdivisions have mean outmovement distances which seem somewhat out of keeping with the trend shown by surrounding areas, which is to suggest that they conform less well to the concentric zonation model. For example, the mean distance is greater than might have been expected in S.Ds. 776 (Mitchell), 786 (Thebarton) and 716 (Torrens). In the first case the high average distance moved is associated with a strong attachment to S.D. 794 (Mawson) (see Fig. 5.1, p.163) an area of high growth situated a considerable distance south-west beyond the hills face zone. Thebarton and Torrens, though inner ring suburbs, have considerable "cross city" attachment (see Fig. 5.1, p.163) which raises the mean distance moved. A lower mean distance is shown for S.D. 805 (Spence North) than would be expected from its position in the total urban structure. This may arise because of tenant transfers between South Australian Housing Trust (S.A.H.T.) premises which exist in high numbers in this area (see map Fig. A21). For example, the neighbouring subdivision 802 (Angle Park) has the highest proportion in Adelaide (54%) of its residents as tenants of the S.A.H.T. while S.D. 805 (Spence North) ranks third (49%).

6.3.3 Internal Moves

It was noted earlier (section 6.2.2) that transfers within Adelaide's electoral subdivisions comprised 21.7 per cent of all the moves registered in this study and that similar proportions had been reported in American studies for moves within census tracts. Using the generalizing techniques described in Section 6.2 the mean length

of internal moves (population-weighted) was found to be 2.5 Km compared with 9.8 Km for moves between subdivisions.

The absolute number of internal moves is very strongly and positively related to the size of the electoral population and the total transfers ($r = 0.86$ and 0.85 respectively; highly significant at better than $.005$ with 48 df). Statistically there is no relationship between the number of internal transfers and the size (area) of the originating subdivision ($r = -0.01$, 48 df). On the other hand, there is a strong positive association between the internal proportion of all transfers and the size of the subdivision ($r = 0.48$, highly significant at better than $.005$, 48 df). These relationships are discussed further in Section 6.4.1.

6.4 DISTANCE MOVED COMPARED WITH OTHER VARIABLES

As discussed already (6.2.2) the mean distance per individual mover (8.2Km) contrasts heavily with the network mean distance (15.9Km). The sequence of systematically relaxed assumptions indicated that this difference derives from the aggregated choices of movers being overwhelmingly in favour of the shorter options. The range of opportunities is represented by a separate line in the graph (Fig. 6.3/2) which also shows the actual choices taken. It is notable, however, that the modal distance class for choices is 2.0 to 2.99 and not the shortest possible. Firm evaluation of the reasons for the relative placement of the modal class is not possible here because of the broad nature of this present study. Nevertheless, the following two explanations are obvious ones which require further research to determine their relative influences upon the distance aspect of mover

choices. Firstly, the geometry of the origin zones themselves may be a factor because of the assumptions made to obtain an expression of distance for moves made within subdivisions. In many of the large subdivisions the component collectors' districts used in estimation are themselves large and could lead to over-estimation of the distance moved internally. Secondly, it may be that people do prefer, when changing residence, to move beyond some yet undefined near threshold. Although this contrasts with views expressed in some of the standard writings it is not a new suggestion, as indicated below.

A review of studies covering the number of movers compared with distance moved in intra-urban migration led Simmons (1968, p.641) to proclaim that "all the suggested distributions feature a sharp decline at first which then levels off" (revised version in Berry and Horton, 1970, p.406). Examples may be quoted from Stouffer (1940, pp.850-852), Olsson (1965), Morrill and Pitts (1967, pp.403-409), and more recently Humphreys (1973, p.32).

It is clear from the graphs in Figure 6.3/2 that there is a rapid decrease in the number of movers between subdivisions with increasing distance from the point of origin ($r = 0.73$, 48 df) but the distribution is neither linear nor normal. In his paper entitled "Migration as a decreasing function of distance" Morrill (1965a, pp.37-39) indicates that the Pareto or gravity type formulae provide the simplest expression of distance decay. It is clear that a curved line of best fit would approach the ordinate asymptotically more like most observed cases (see also Clark, 1970, pp.52-55). However, it was noted more than a decade ago by Morrill (1963, p.82) when attempting to fit to his data, five different standard curves for migration distance decay, that all

exaggerated the number of short moves. Amongst the reasons he suggested was that the heavy expense of moving residence may make the very short move unattractive compared with the medium-short transfer. Trends similar to those reported in this present study have been published by Adams (1969, p.316) and Clark (1970, pp.52 and 55).

6.4.1 Size of S.D. and distance

An important factor underlying all the discussion to this point is that the spatial data units, the electoral subdivisions, are extremely variable in size - a fact which would seem to influence the relative differentiation of movers into internal and external. That indices of outmigration are highly sensitive to the size of the area from which movement occurs has been noted by Moore (1966b, p.94) and others. It seems, therefore, a reasonable assumption that in the hypothetical case of two electoral subdivisions, which are equal in all respects except in their territorial extent, the larger area would contain a larger number of internal changes of address. This assumption rests on the hypothesis, not yet tested in this study, that the number of internal moves is dependent on the area of the subdivision. This was put to the statistical test using Pearson's Correlation Coefficient as an indication of the strength of the relationship between area (in square kilometres) of the electoral subdivisions (variable X) and a selection of other variables (Y). The results were as follow:

variable (Y)	Pearson's Correlation Coefficient
. mean electoral population	-0.15 not significant
. total transfers	-0.23 not significant
. number of internal movers	-0.01 not significant
. % of all moves internal to S.D.	0.48 significant *

(* significant at better than .005, 48 df)

This demonstrates clearly that the size of the data unit has a slight, but insignificant, negative relationship with the absolute number of electors and the total number of transfers. In contrast, however, the proportion of the latter which is internal is highly significantly related to the size of the originating subdivision, such that the larger the area the higher the proportion of internal transfers.

Another result which follows predictably from those already reported is that several factors are closely interrelated with distance of the origin S.D. from the central business district. These relationships, and those discussed earlier, are shown in the accompanying diagram (see Fig. 6.5). It is apparent that the size of the subdivisions is closely related to the distance of the origin from the C.B.D. and furthermore, that the mean distance (length) of the intra-urban transfer is even more closely related to both the size of the originating subdivisions and the distance of the subdivision from the C.B.D. (see also Fig. 6.4/2). A little less closely related (negatively) to the mean length of transfer is population (elector) density which is itself just as strongly related to originating distance from the C.B.D.

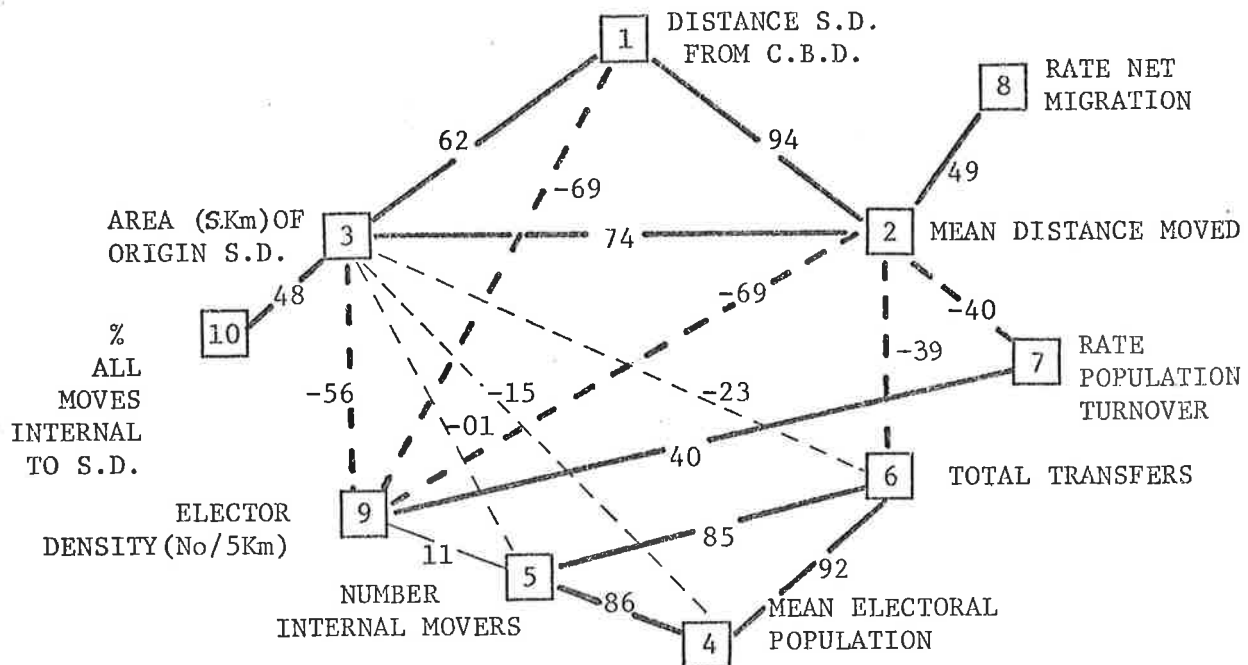

Key to Correlation Coefficients

_____ Positive and significant* _____ Positive, not significant
 - - - - Negative and significant* - - - - Negative, not significant

*Significant at .005 or better, with 48 degrees of freedom.

FIG. 6.5 Pearson correlation coefficients between mean distance moved and selected variables.

6.4.2 Movement indices and distance

Implicit in much of the discussion in Chapter 4 (section 4.3) of indices of annual population movement rates and their spatial distribution is the idea that there are systematic relationships with the independent variable 'distance moved'. This was tested therefore by application of Pearson's Correlation Coefficient to subdivisional scores

with the following results.

(a) Population turnover; $r = -0.40$

(b) Net migration; $r = 0.49$

Both pairs of relationships are highly significant at much better than 0.005 (df 48). It is clear, therefore, that high population turnover rates, which were shown separately to be associated with inner city locations, also have a tendency to accompany short distance transfers. In contrast low rates of turnover tend to occur in outer urban areas and are associated with longer distance moves. Also associated strongly with areas generating long moves are high rates of net migration. Conversely, low rates of net migration occur in areas of short distance transfers.

The trends shown in the factors above may be combined into a collective description of the inner and outer areas respectively of the Adelaide Statistical Division. Such a summary follows. The electoral subdivisions in the inner city areas (those near the C.B.D.) generally have the following comparative characteristics

- . small area
- . high density of electors per unit area
- . low proportion of internal movers
- . low mean distance moved on transfer of residence
- . low rate of net migration (often negative)
- . high rate of population turnover

In contrast, subdivisions in areas of greatest distance from the C.B.D. tend to have the following characteristics

- . large areas
- . low density of electors per unit area

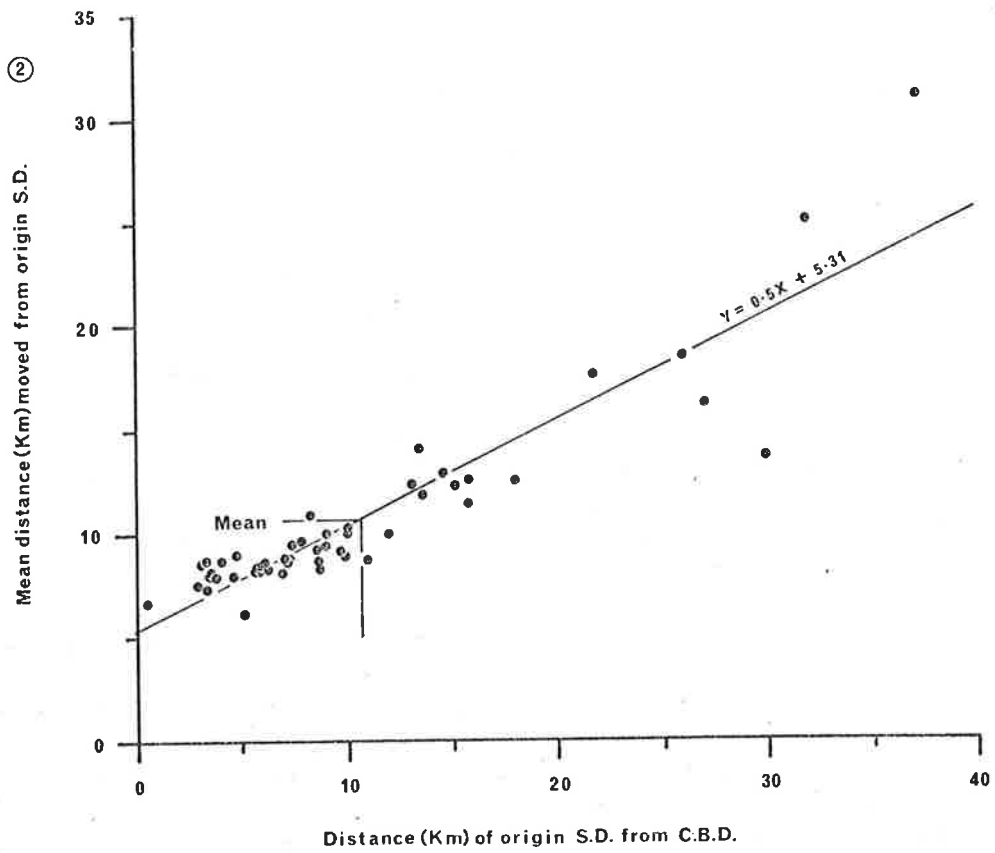
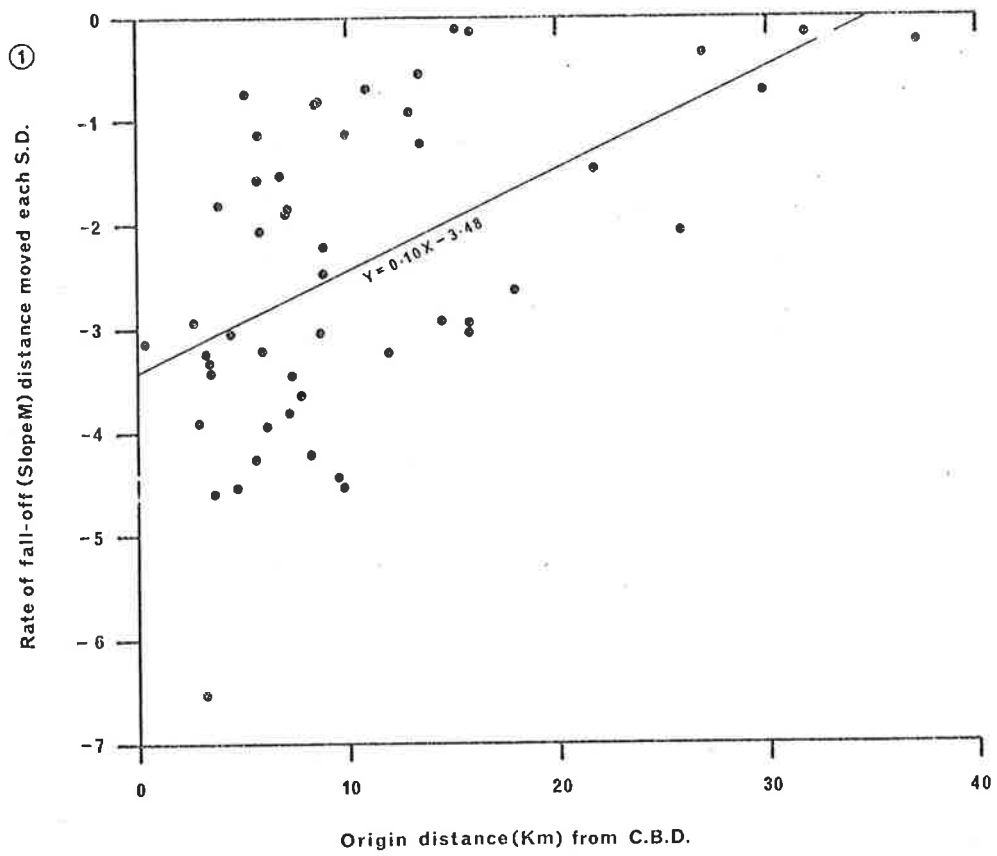

FIG. 6. 4. Distance of C.B.D. from each origin subdivision compared with (1) rate of fall-off in number of moves with distance and (2) mean distance moved.

- . high proportion of internal movers
- . high mean distances moved on transfer of residence
- . high rate of net migration (high growth areas)
- . low rate of population turnover

6.4.3 Rate of fall-off with distance of origin from C.B.D.

The mean distance moved from each subdivision was mapped (see Fig. 6.2) and discussed in section 6.3.1. This distribution clearly implies that outmovements from different origins are absorbed into the surrounding territories at different rates with increasing distance of the origin from the city centre. For example, it was apparent in the previous chapter (Figure 5.2) that most moves out from S.D. 711 (Adelaide, mean external 6.7 Km) are absorbed over a shorter range of distance than was the case from S.D. 730 (Alexandra, mean external 25.1 Km). However, objective comparison of the rate of fall-off with distance from the origin is difficult from maps alone. Therefore the following procedure was used in order to achieve a more objective description of this feature of outmovement patterns.

The earlier processing of distances involved graphing separately for each subdivision the number of moves against distance and the calculation of regression lines and correlation coefficients. By definition the calculated slope ('m') of the regression line represents a generalization of the rate of fall-off in the number who move, plotted against increasing distance from the origin centroid. This therefore is an objective measure on which subdivisions can be compared with one another as in Figure 6.4/1.

The slope of the regression line for each subdivision has been plotted against the distance of the centroid from the C.B.D. (see Fig. 6.4/1). The two measures have a Pearson's Correlation Coefficient of 0.54, significant at better than 0.005 (df 48). The notion is confirmed therefore that not only do the inner city areas on average have short moves (see Fig. 6.4/2) but that most moves are absorbed over a short range. On the other hand peripheral subdivisions have longer moves which are absorbed over a greater range of distances. The relationship between the mean distance moved and the distance of the origin from the C.B.D., as discussed already, is statistically highly significant with a Pearson's Correlation Coefficient of 0.94 (df 48). The relationship between distance of movement, absorption rates and position of origin may be summarized as follows. There is a decreasingly negative rate of fall-off in transfers with increasing distance of the point of origin from the C.B.D.

6.4.4 Ethnicity

Gibson (1967, pp.67-68) in her Adelaide study of individual residential movements of Dutch and Greek migrants was free of the restraints of administrative geographic areas. Important differences were noted between the two nationalities in the distances they moved in intra-urban changes of residence between 1956 and 1966. Dutch migrants moved an approximate mean distance of 4.8 Km and Greeks 0.7 Km. About 48 per cent of Dutch moves were under 6.5 Km compared with 93 per cent of Greek moves. In the present study covering all electoral moves, about 57 per cent were under 6.5 Km in length.

6.4.5 Forced moves

In another Adelaide example involving residential movement Griffiths (1973, p.16a) studied households from three separate areas after they had been forced to change house by different scheme involving large scale property acquisition. It was found that about 78 per cent moved less than 6.5 Km and mean distances moved by the three groups were 5.0, 5.6, and 5.9 kilometres respectively.

6.5 SUMMARY

It has been shown in this chapter that there are significant systematic differences in the distances people move on changing residence within the Adelaide Statistical Division. These differences have been shown to be related to the relative location of the originating home within the urban area, especially with regard to distance from the C.B.D. and population density. Even allowing for the predisposing geometry of the network and population distribution, aggregated movements have been shown to be strongly biased overall to the shorter distance transfers, but the more so in inner areas. Further investigation is necessary to determine the nature of population characteristics associated with differences in distance moved.

One conclusion which may be drawn from locally conducted work cited above is that population subgroups, differentiated on grounds of ethnicity, place of residence or motivation for moving, display different distance preferences in their choice of a new residence. It is probable, therefore, that the descriptions reported in this study and based on large aggregations encompass considerable meaningful

internal divergence which yet remains largely unexplored.

There are many other measures which may vary systematically in association with distances transferred by electors. Most important in the present context are population characteristics such as age, occupation, socio-economic status and level of educational attainment. Discussion of relationships of this kind is left until the final chapter. Another factor of more immediate concern which is discussed in the next chapter is that of the possible relationship between direction of movement and distance, because

"the interaction of the lengths of streams with their direction can provide a more suitable characterization of the flows than distance alone provides"

(Wolpert, 1967, p.606).

REFERENCES

- ADAMS, J.S. (1969) 'Directional Bias in Intra-urban Migration'. Economic Geography, vol. 45, no. 4, pp.302-323.
- ALBIG, W. (1933) 'The Mobility of Urban Population'. Social Forces, vol. 11, pp.351-367.
- BERRY, B.J.L. and HORTON, F.E. (1970) Geographical Perspectives on Urban Systems with Integrated Readings. Prentice-Hall, New Jersey.
- BOYCE, R.R. (1969) 'Residential Mobility and its Implications for Urban Spatial Change'. Proceedings, Association of American Geographers, I, pp.22-26.
- BROWN, L.A. and HORTON, F.E. (1970a) 'Functional Distance: An Operational Approach'. Geographical Analysis, vol. 2, no.1, pp.76-83.
- BROWN, L.A. and HORTON, F.E. (1970b) 'Social Area Change: An Empirical Analysis'. Urban Studies, vol. 7, no.3, pp.271-288.
- CAPLOW, T. (1949) 'Incidence and Direction of Residential Mobility in a Minneapolis Sample'. Social Forces, vol. 27, pp. 413-417.
- CLARK, W.A.V. (1970) 'Measurement and Explanation in Intra-urban Residential Mobility'. Tijdschrift Voor Econ. En. Soc. Geog., vol. lxi, no. 1, pp.49-57.
- GIBSON, J.G. (1967) 'The Residential Pattern and Mobility of Dutch and Greek Migrants in the Adelaide Metropolitan Area'. Unpublished thesis. Dept. of Geography, University of Adelaide.
- GREEN, H.W. (1934-42). 'Movements of Families within the Cleveland Metropolitan District'. Real Property Inventory of Metropolitan Cleveland, Reports numbers 3,5,7,9,11, 13,15 and 17.
- GRIFFITHS, K.R. (1973) 'The Effects of Relocation: A Reappraisal of Acquisition.' Unpublished thesis, Dept. of Geography, University of Adelaide.
- HUMPHREYS, J.S. (1973) 'Intra-urban Migration and Residential Structure'. No. 6, Monash Publications in Geography, Dept. of Geography, Monash University, Melbourne.

- JOHNSTON, R.J. (1971a) 'Some Limitations of Factorial Ecologies and Social Area Analysis'. Economic Geography, vol. 47, no.2, (Supplement), pp.314-323.
- JOHNSTON, R.J. (1971b) Urban Residential Patterns. An Introductory Review. G. Bell and Sons, London.
- JOHNSTON, R.J. (1973b) 'On Frictions of Distance and Regression Coefficients'. Area, vol. 5, no. 3, pp.187-191.
- MOORE, E.G. (1966b) 'Residential Mobility in an Urban Context: A Systems Approach'. Unpublished Ph.D. thesis, University of Queensland.
- MORRILL, R.L. (1963) 'The Distribution of Migration Distances'. Papers and Proceedings of the Regional Science Association, vol. xi, pp. 75-84.
- MORRILL, R.L. (1965a) 'Migration and the Spread and Growth of Urban Settlement'. Lund Studies in Geography, Series B. No. 26.
- MORRILL, R.L. and PITTS, F.R. (1967) 'Marriage, Migration and the Mean Information Field: A Study in Uniqueness and Generality'. Annals, Association of American Geographers, vol. 57, pp.401-422.
- OLSSON, G. (1965b) Distance and Human Interaction. A Review and Bibliography. Bibliography Series no. 2. Regional Science Research Institute.
- ROSS, H.L. (1962) 'Reasons for Moves to and from a Central City Area'. Social Forces, vol. 40, pp.261-263.
- SIMMONS, J.W. (1968) 'Changing Residence in the City - A Review of Intra-urban Mobility'. Geographical Review, Vol. 58, no. 4, pp.622-651.
- STOUFFER, S.A. (1940) 'Intervening Opportunities: A Theory Relating Mobility and Distance'. American Sociological Review, vol. 5, pp.845-867.
- WOLPERT, J. (1967) 'Distance and Directional Bias in Inter-urban Migratory Streams'. Annals, Association of American Geographers, vol. 57, pp.605-616.

CHAPTER 7

DIRECTIONS OF OUTMOVEMENT

The problem can be simplified by classifying moves according to distance and direction.

ROSS (1962, p.261)

The interaction of the lengths of streams with their direction can provide a more suitable characterization of flows than distance alone provides.

WOLPERT (1967, p.606)

OUTLINE

This chapter begins with an outline of selected studies concerned with directional characteristics of intra-urban migrants. Directional bias emerges as the feature of prime concern. This is followed by discussion of the problems of analysing and generalizing circular data and the present lack of adequate tools. The technique then described was specially developed for the present study to identify for each origin a single 'dominant direction of outmovement'. Associated with the technique is the generation of an 'index of concentration' to describe the spread of values around the peak. These two measures enable comparison of dominant direction of outmovement with reference to the direction of the C.B.D. and with distance of origins from the C.B.D. Furthermore it is found that the Index of Concentration has systematic relationships with both distance and direction of intra-urban movement.

CHAPTER 7: DIRECTIONS OF OUTMOVEMENT

CONTENTS		Page
7.1	INTRODUCTION	206
7.2	SOME PREVIOUS STUDIES	206
7.3	ANALYSIS OF CIRCULAR DISTRIBUTIONS	211
	7.3.1 Some General Problems	211
	7.3.2 Background to the Special Technique	214
	7.3.3 Special Technique	217
	7.3.4 Index of Concentration	220
7.4	THE CASE STUDY	222
	7.4.1 The Data and Some General Impressions	222
	7.4.2 Dominant Direction of Outmovement	227
	7.4.3 Index of Directional Concentration of Outmovement	236
7.5	SUMMARY AND CONCLUSIONS	239
	REFERENCES	242

CHAPTER 7: DIRECTIONS OF OUTMOVEMENT

LIST OF FIGURES

Figure	Page
7.1 Allocation of cosine values to directional classes in calculation of Dominant Direction of Outmovement	facing p.218
7.2 Graphs for selected subdivisions showing numbers and directions of intra-urban outmigrations	facing p.223
7.3 Diagrams for selected subdivisions showing volume, distance and direction of intra-urban migrations	under p. 223
7.4 Composite diagram of Adelaide Statistical Division showing for each electoral subdivision the volume, distance and direction of outmigrations	facing p.224
7.5 Histograms for aggregated electoral subdivisions Adelaide Statistical Division showing number of intra-urban migrations against direction with reference to (1) grid north (2) C.B.D.	facing p.225
7.6 Maps showing for each electoral subdivision in the Adelaide Statistical Division (1) classification in a threefold concentric zonation (2) the mean outmovement by volume, distance and direction	facing p.228
7.7 Map showing for each electoral subdivision the quintile classification of the dominant direction of outmovement with the C.B.D. as orientation node.	facing p.229
7.8 Graphs showing percentage cumulative frequency of direction of outmoves (C.B.D. as orientation node) Adelaide Statistical Division: (1) range 0° to 180° (2) 0° to 180° and -180° to 0°	facing p.231
7.9 Graphs comparing (1) Distance of origin from C.B.D. (2) Mean length of outmigration, with dominant direction of outmovement	facing p.234

CHAPTER 7: DIRECTIONS OF OUTMOVEMENT

LIST OF FIGURES (Cont.)

Figure		Page
7.10	Map showing for each subdivision the quintile classification of the index of directional concentration of outmigration	facing p. 237
7.11	Graphs showing variation in indices of concentration with (1) distance of origin from C.B.D. (2) dominant direction of outmovement	facing p. 238

CHAPTER 7. DIRECTION OF OUTMOVEMENT

LIST OF TABLES

Table		Page
7.1	Summary of A.S.D. numbers and percentages of electoral transfers by direction of out-movement with C.B.D. as orientation node	facing p. 215
7.2	Dominant direction of outmovement (Ref. C.B.D.) and Index of Directional Concentration for each electoral S.D. in the Adelaide Statistical Division	facing p. 219
7.3	Three concentric origin zones, showing percentage of transfers from each, directed toward, away from or laterally, with respect to the Central Business District (C.B.D.)	232
7.4	Correlation coefficients between annual rates of population movement and distance and direction moved	235
7.5	Selected population and elector movement characteristics for three concentric zones of electoral subdivisions in the Adelaide Statistical Division, 1970-71	under p.238

CHAPTER 7: DIRECTIONS OF OUTMOVEMENT

7.1 INTRODUCTION

In the last chapter two components of electoral transfers within the Adelaide area, volume and distance, were considered. In this chapter the major topic is to be the direction followed by streams of intra-urban migrants. At first, direction moved will be considered as a single variable and then in combination with the former two. For the purpose of this analysis the urban area will continue to be considered as a closed system (see Moore, 1969, p.114) with movement aggregations based upon the generalizing assumption that movements between electoral subdivisions begin and end at the centroid of each of the fifty subdivisions. The data for directional analysis is contained in two matrices, Table 5.1 and Appendix F. The first has been used already and shows the number of migrants utilizing each link while the second shows the directions between all centroids calculated from the map coordinate reference grid as explained in section 4.6.2.

7.2 SOME PREVIOUS STUDIES

Adams (1969) made an important contribution to thinking on the spatial distribution of intra-urban migrations when he published evidence that such moves were not random but exhibited what he called "directional bias". Brown and Holmes (1971, p.104) have claimed that "directional bias describes the degree to which a single migration is more likely to end in a place that is in a

particular direction from the origin." Humphreys (1973, p.34) has defined directional bias as "the degree of destination nodal concentration existing in a certain direction with respect to an orientation node". For most studies the Central Business District is taken as the orientation node, the origins as 'reference nodes' and destinations as 'related nodes' (see Brown and Holmes, 1971, p.107).

Adams argued from his three time samples drawn from Minneapolis that direction of movement varied systematically within urban areas. He claims that migrants from inner areas moved outward away from the C.B.D., middle suburban migrants moved laterally and those from outer areas moved toward the C.B.D. He offered the explanation (Adams, 1969, p.323) that because residents "build up and retain a narrow, perhaps wedge-shaped image of the city which is sharply in focus for places close to home and other parts of the home sector, and blurry or blank for distant places", when they decide to move house they tend to do so within their existing activity space (Brown and Moore, 1970). The original paper by Adams has inspired a considerable and growing number of others. For example, Horton and Reynolds (1970) showed that residents from the central areas of Cedar Rapids had no directional bias but those from the suburbs did exhibit sectorial characteristics, while Donaldson and Johnston (1973) found considerable support for Adams's hypotheses when they tested them in Christchurch, New Zealand. Clark (1970 and 1971) working in the same city tested for bias by comparing a city wide distribution of urban migrant networks with a randomly generated one.

His tentative findings were that household movements from central regions were spatially random while those from outer areas which comprised only one-third of total movements were sectorially biased. Using mean information field data Clark (1970) successfully simulated the spatial distribution of migrant destinations within a 40 cell matrix thereby adding support to the notion that for given populations life space and migration fields occupy similar territories.

The association of length of time spent searching for a house and the period of residence before moving was shown to influence spatial bias in the areas actually searched by people in the south-eastern suburbs of Melbourne (Whitelaw and Gregson, 1972). The likelihood that within an urban area points other than the C.B.D. may also be associated with directional bias has been shown by Whitelaw and Robinson (1972). It was argued that for many people their activities are sectorially biased when work, shopping and recreational places do not coincide in the C.B.D. It was shown that in predicting orientation of intra-urban migrants "the commuter axis in the Melbourne context is as sensitive as the C.B.D. axis" (Whitelaw and Robinson, 1972, p.192).

It has been observed by Simmons (1968, p.649), Rossi (1955), Johnston (1971b) and others that "urban social areas are not only stable but they appear to persist in their bio-social characteristics unaffected by the particular persons who inhabit them" (Tryon, 1967, p.467). Humphreys (1973) has shown that in Melbourne the majority of moves occur between areas of the same or similar

type thus preserving spatial distributions of socio-economic class structures. It can be argued therefore that the distance and direction taken by movers depend upon the relative location of areas similar to the ones in which they already live. It is not surprising therefore that the distribution of contact fields, search patterns and destination nodes all tend to differ between population subgroups (Moore, 1971), thereby emphasizing the importance of intra-urban migration "in maintaining the socially differentiated residential structure of the city" (Humphreys, 1973, p.36).

The works cited have demonstrated beyond doubt that directional bias is an important attribute of migratory movements particularly within urban areas. It is becoming increasingly clear that there are many concomitant population and environmental characteristics making simple explanation impossible (see Ross, 1962, p.261). Furthermore it has been observed that "since the same spatial pattern of migrations could be produced by a number of processes, it is not possible to observe a pattern and infer back to its cause" (Johnston, 1971b, p.295).

However underlying all studies on intra-urban migration are two large basic problems which must be relieved if progress is to continue in investigations into this phenomenon. The first problem in pursuing empirical research concerns the acquisition of suitable data at the aggregate level which "in itself constitutes a major research task" (Moore, 1969b, pp.114-115). This has already been discussed in earlier chapters of the present study (especially

Chapters 2 and 3). The second problem concerns the dearth of readily available techniques for summarizing the geometrical elements of the migration streams (Wolpert, 1967, p.605). Although considerable progress has been made since Wolpert expressed his concern, the need is almost as great as ever so that the complaint is still justified that "relatively little attention has been given to the spatial patterning and geometrical aspects of intra-urban migrations" (Brown and Holmes, 1971, p.103).

With the large amount of movement data accumulated over an entire city in the present study the need at this point is for clear representation, both visually and numerically, of directional trends. The difficulties of the task are aggravated by the combination of large numbers of movers, and a relatively large number of points to which aggregations of departures and dispersions have been generalized. This may be contrasted with the other recent studies where the emphasis and scale have been of a different order. For example, where the major interest has been on process, data has been gathered for a selected portion only of an urban area as in Whitelaw and Robinson (1972), Whitelaw and Gregson (1972), Donaldson and Johnston (1973) and Humphreys (1973). The emphasis in the present study is on the holistic identification and description of movement patterns over the entire area of a moderately large city. An inspection of a map of the 2,133 active links identified in this study of Adelaide merely makes clear that "flows and counterflows criss-cross the urban area" (Simmons 1968, p. 403) and that while differing greatly in volume and length they seem to lead in every possible direction.

It is readily apparent that for patterns to emerge from the mass of data it is necessary to employ descriptive devices, preferably of an objective kind to isolate or highlight dominant directions of movement. Only when this has been achieved can adequate checks be made of the nature and extent of directional bias.

7.3 ANALYSIS OF CIRCULAR DISTRIBUTIONS

7.3.1 Some general problems

Adams (1969) checked his sample of intra-urban migrations for directional bias by measuring for each separate move the angle subtended between lines connecting the place of origin (reference node) first with the Central Business District (the orientation node) and secondly with the destination (related node). (The terms in brackets are from Brown and Holmes, 1971, p.107). Variations on this basic procedure have been followed in various comparative studies since its first publication (see, for example, Brown and Holmes, 1971; Whitelaw and Robinson, 1972; Whitelaw and Gregson, 1972). However because the present case is using data already partly aggregated before acquisition such direct testing of individual moves is impossible. Nevertheless it does seem logical that the same kind of analysis could be conducted on aggregated data provided the same necessary parameters can be extracted.

In this present study which uses aggregated data the following information required in Adams's directional analysis has been used and discussed already:

- (1) location of C.B.D., origins and destinations (centroid of each S.D.)
- (2) distance and direction from each origin to the C.B.D.

The only remaining measure necessary to apply a check on directional bias in the present aggregations of outmovements is a simple generalization of direction of outmovement in terms of a single vector. The problem at this point is how to achieve this in a meaningful manner from the existing data.

Outmovement was represented diagrammatically in Chapter 5 (see Figs.5.1, 5.2 and 5.3) with proportional arrows radiating in all directions from subdivisional centroids. Despite the simplifying assumption on which this was based, it makes clear that flows from most origins are distributed in an approximately circular pattern. In a linear distribution the calculation of the arithmetic mean provides a suitable measure of central tendency along with its associated measures of dispersion, skewness and kurtosis to describe deviance from normality. This kind of statistical analysis cannot be employed in the present case because "angular or directional data are not amenable to the use of ordinary statistical procedures" (Jones, 1968, p.61). This applies to both the determination of an orientation peak and the estimation of the degree of scatter about that point (see Waterman 1963) which are the two descriptive elements requiring objective identification in the present study.

There are available certain formulae (Jones, 1968, p.63) whose application enables directional data to be tested merely for

presence or absence of distributional uniformity. However, in the present case, testing of this kind is unnecessary because visual inspection of maps and graphs has provided already conclusive evidence of the absence of uniformity. The need in the present circumstances is rather for a way to identify the kind and degree of directional bias, an attribute whose presence is already established.

Jones (1968, p.61) points out that the basic difficulty in analysing directional data is the choice of a directional origin or starting point on the imagined circle around the reference node. He demonstrates this by reference to the experience of Krumbein (1939) in the construction of directional histograms. It is clear that the reference point (zero degrees) may be arbitrarily located anywhere on a circle and that 0 degrees and 360 degrees are one and the same point. The question arises therefore as to where to cut the circle so that there are ends to the distribution. An acceptable but not entirely satisfactory answer to the problem is to pre-sort observation sets according to the directional range or angular spread of values. Those with a total range of less than two radians (114 degrees) may be treated as linear normal distributions (Jones, 1968, p.64 citing findings from Agterberg and Briggs 1963). Although there are certainly some cases of this kind in the present study most are not, and where material being processed is mixed it is preferable to treat all data according to circular estimates (Jones, 1968, p.65).

Circular estimation involves determination of a vector mean and its data scatter by application of the circular normal distribution expressed as an exponential cosine function derived from Mises (1918). (Mises's original text is in German but suitable formulae and explanations are provided by Waterman, 1963, p.101, and Jones, 1968, pp.63-64). It is pointed out by Jones (1968, p.64) that this technique estimates the mode of the circular normal distribution rather than the mean and is really designed to handle samples. The present case utilizes data on a total population and the mode (the most populous directional class) is already identified. Therefore this technique was rejected as unsuitable.

It seemed that there was no readily available technique eminently suited to the task in hand and consequently it was decided to attempt the development of a special technique. Further encouragement in this pursuit was derived from the fact that no loss of direct comparability with existing studies was likely to be incurred by the adoption of a unique method because the literature search had not uncovered any work utilizing directional indices of aggregated human migration.

7.3.2 Background to the special technique

At the time of attempting development of a special technique the following data of calculations were already on hand:

- (1) a network of fifty origin-destination points, and a central business district, with respective locations, connecting

TABLE 7.1

Summary of Adelaide Statistical Division Numbers and Percentages of Electoral Transfers by Direction of Outmovement
with C.B.D. as Orientation Node.

Direction (degrees)	No. of transfers	Percentage of total	Cumulative percentage	Direction (degrees)	No. of transfers	Percentage of total	Cumulative percentage	Direction (degrees)	No. of transfers	Percentage of total	Cumulative percentage
2	938	2.35	2.35	122	492	1.23	40.57	-118	421	1.05	60.94
6	1353	3.39	5.74	126	468	1.17	41.74	-114	311	0.78	61.72
10	985	2.47	8.21	130	149	0.37	42.11	-110	181	0.45	62.17
14	890	2.23	10.44	134	62	0.16	42.27	-106	198	0.50	62.67
18	793	1.99	12.43	138	35	0.09	42.36	-102	450	1.13	63.80
22	730	1.83	14.26	142	399	1.00	43.36	-98	382	0.96	64.76
26	665	1.66	15.92	146	301	0.75	44.11	-94	304	0.76	65.52
30	638	1.60	17.52	150	253	0.63	44.74	-90	168	0.42	65.94
34	567	1.42	18.94	154	137	0.34	45.08	-86	284	0.71	66.65
38	592	1.48	20.42	158	150	0.38	45.46	-82	192	0.48	67.13
42	455	1.14	21.56	162	434	1.09	46.55	-78	532	1.33	68.46
46	1021	2.56	24.12	166	309	0.77	47.32	-74	194	0.49	68.95
50	651	1.63	25.75	170	246	0.62	47.94	-70	327	0.82	69.77
54	550	1.38	27.13	174	418	1.05	48.99	-66	349	0.87	70.64
58	420	1.05	28.18	178	344	0.86	49.85	-62	534	1.34	71.98
62	499	1.25	29.43	-178	230	0.58	50.43	-58	469	1.17	73.15
66	457	1.14	30.57	-174	493	1.23	51.66	-54	609	1.52	74.67
70	394	0.99	31.56	-170	339	0.85	52.51	-50	587	1.47	76.14
74	240	0.60	32.16	-166	487	1.22	53.73	-46	535	1.34	77.34
78	248	0.62	32.78	-162	145	0.36	54.09	-42	511	1.28	78.76
82	216	0.54	33.32	-158	248	0.62	54.71	-38	497	1.24	80.00
86	410	1.03	34.35	-154	0	0.00	54.71	-34	554	1.39	81.39
90	286	0.72	35.07	-150	214	0.54	55.25	-30	721	1.81	83.20
94	157	0.39	35.46	-146	529	1.32	56.57	-26	812	2.03	85.23
98	355	0.89	36.35	-142	115	0.29	56.86	-22	866	2.17	87.40
102	403	1.01	37.36	-138	292	0.73	57.59	-18	823	2.06	89.46
106	305	0.76	38.12	-134	66	0.17	57.76	-14	619	1.55	91.01
110	82	0.21	38.33	-130	234	0.59	58.35	-10	1296	3.24	94.25
114	291	0.73	39.06	-126	200	0.50	58.85	-6	1017	2.55	96.80
118	110	0.28	39.34	-122	414	1.04	59.89	-2	1295	3.20	100.00

Source: Author's reprocessing of data supplied by State Electoral Dept., Adelaide.

distances and directions (See Fig. 4.13 and Appendices E and F)

- (2) the angles between all points in the network measured with separate reference to both grid north and the C.B.D. (See Appendix G)
- (3) the number who transferred along each active link, the total movers from each origin and therefore the grand total of intra-urban migrants (See Table 5.1)
- (4) the number of active links and the maximum possible links (See Table 5.2)
- (5) the number of transfers along each active link arranged into angular classes, derived from (2) and (3) above, and as explained below (See Appendices H and I)

In order to allocate transfers to angular classes and to represent them at both the subdivisional level and the whole study area it was necessary to do some amalgamation. The initial calculation of the inter-connecting bearings between centroids was to within one-tenth of one degree and each subdivision had a possible maximum of 49 active links. In the directional aggregation it seemed desirable for mapping purposes to preserve as many individual active links as possible, therefore it was decided that the number of classes should exceed at least 49. The decision was made to have ninety classes, each with a four-degree range. Accordingly they were set up and transfers allotted (see Table 7.1 for A.S.D. only, and Appendices H and I for the subdivisions). At the same time a cross-tabulation was prepared

showing the number who moved both by distance and by direction (Appendices H and I).

Grid north was taken as the initial reference for determination of all directions because that was the basis of the locational map grid from which the subdivisional centroids were themselves derived. However it could not be expected that this orientation reference would have any meaningful relationship with intra-urban movement patterns. On the other hand, the structural and organisational centre of an urban area, the C.B.D., has been shown to be functionally significant to direction of intra-urban movement. For example, Brown and Holmes (1971, p.107) remark that an important aspect of Adams's work is the definition of directional bias in terms of a node which is functionally significant to the movement being studied. Therefore in the present study all directional data has been accumulated into a second record for which the C.B.D. is the orientation node. This means that for each origin subdivision direction of outmovement is measured as a deviation in degrees from the principal axis - a line from the centroid to the C.B.D. The direction of the C.B.D. from the centroid is therefore zero degrees. Transfers to the right of the principal axis are given a positive bearing whose maximum possible value is 180 degrees in opposition to the C.B.D. Moves to the left of the principal axis are negative and decrease around the semicircle to minus 180 degrees at the point coincident with plus 180 degrees.

Two diagrams to show the directional distribution of residential outmovement were prepared for each subdivision. Firstly a circular or polar graph with lines of scaled thickness portrays the number who move in each directional class, while the length of the lines shows the distance moved (see Fig. 7.3 and Appendix D). Secondly, a histogram was drawn showing the number of movers in each directional class without any reference to distance moved but using a horizontal directional scale referring to both grid north and the C.B.D. A selection only of these is shown in Figure 7.2, which makes clear the wide variety in the directional spread of outmovement. Furthermore where movement is in all directions some origins have a single mode while others have multiple modes and yet other cases display movement concentrated in one or more distinct sectors of a circle. One feature which emerges from both diagrammatic representations is the need for an objective identification of a central tendency "dominant direction" or vector mean.

7.3.3 Special technique

The conventional method of calculating the arithmetic mean of grouped linear data involves finding the product for each observation class (number of occurrences multiplied by the measure) and then dividing the sum of all products by the total number of occurrences. If in the directional or circular case a simple numeric sequence (usually degrees) is used as the measure, false, misleading or ambiguous answers sometimes are obtained. This results in part from the fact that the beginning and end points

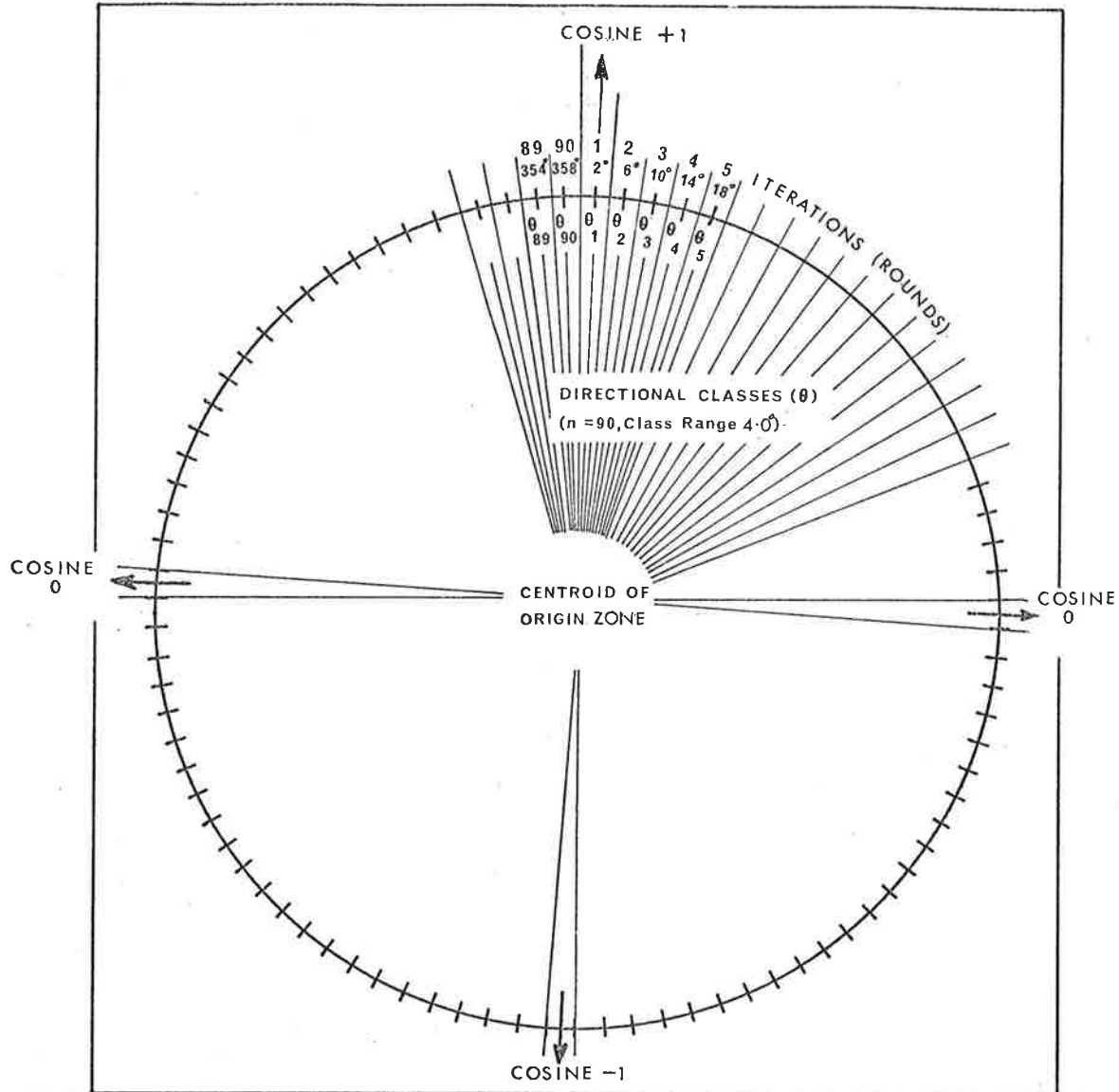

FIG. 7.1 Allocation of cosine values to directional classes in calculation of Dominant Direction of Outmovement.

- Notes:
- Each outmovement directional class takes the central value of its 4.0 degrees range.
 - Each new round begins one class further to the right of 0 degrees, until every class has once been the starting point (90 class, 90 rounds).
 - The 'beginning class' in each round is allocated the cosine value 'plus 1' and others follow in clockwise order. The sum of cosine-mover products for the round are designed to the "beginning class".
 - The Dominant Direction is that class which generates the highest total sum of cosine-mover products.

(the extremes of the continuum) are in fact coincident so that zero degrees and 360 degrees are one and the same and yet produce a mean value of 180 degrees. Although for directional reference any point in a circle may be chosen and that quite arbitrarily, it has been shown that the choice may produce differing results in some circumstances. The immediate need therefore, in the present case, is to discover the best position to break the circle in order to identify, without ambiguity, the dominant direction of out-movement.

The following technique attempts to overcome the disadvantages discussed above by utilizing cosine-mover products. An underlying assumption is that the dominant direction of outmovement for a given origin is represented by that directional class which produces the maximum total sum of cosine-mover products. To avoid breaking the circle in only one place each of a number of directional classes (in this case ninety) is taken in turn as the first or orientation node of a clockwise succession of calculations.

The following method was applied to each subdivisinal origin in turn (see Fig. 7.1).

- (1) The 'beginning class' is that angular class immediately to the right of the principal axis, in this case a line connecting the origin centroid to the C.B.D. (the selected external orientation node, see p.216). The centre of this class is allocated the value of 0 degrees (cosine 'plus 1') and all other classes are then numbered consecutively in a clockwise direction.

TABLE 7.2

Dominant Direction of Outmovement (Ref. C.B.D.) and Index of Concentration for each Electoral Subdivision in the Adelaide Statistical Division.

CODE NO.	SUB.DIVISION	1 Dominant Direction	2 Rk	3 Index of Concen- tration	4 Rk	CODE NO.	SUB.DIVISION	1 Dominant Direction	2 Rk	3 Index of Concen- tration	4 Rk
71=	ADELAIDE					78 =	HINDMARSH				
711	Adelaide	97.8	2	4.95	46	781	Beverley	12.0	30	10.23	40
712	Florey West	14.9	28	16.15	31	782	Hanson North	6.8	39	33.47	12
713	Gilles West	0.7	48	8.43	42	783	Henley Beach	3.7	43	34.10	11
714	Ross Smith	29.7	14	24.02	24	784	Peake	15.4	27	12.71	37
715	St. Peters	46.1	9	4.24	48	785	Spence South	9.1	35	4.43	47
716	Torrens	43.9	10	11.20	39	786	Thebarton	37.7	11	4.15	49
72 =	ANGAS (Part)					79 =	KINGSTON				
722	Fisher East	22.7	18	46.41	6	791	Brighton	0.3	50	24.77	22
724	Heyson North(part)	27.8	15	32.66	14	792	Glenelg	19.8	19	24.25	23
73 =	BARKER (Part)					793	Hanson South	55.3	5	26.13	21
730	Alexandra(part)	11.3	32	55.28	2	794	Mawson	1.8	47	43.51	7
731	Fisher South	10.1	34	40.24	8	80 =	PORT ADELAIDE				
732	Flagstaff Hill	11.8	31	26.83	20	801	Albert Park	16.5	25	29.28	17
736	Moana	54.9	6	38.53	10	802	Angle Park	16.1	26	17.58	29
74 =	BONYTHON					803	Price	8.8	36	20.74	25
741	Elizabeth	3.6	44	48.96	4	804	Semaphore	5.5	41	49.17	3
742	Florey East	17.2	23	16.12	32	805	Spence North	10.5	33	9.50	41
743	Modbury North	5.7	40	32.71	13	81 =	STURT				
744	Playford	18.3	20	20.58	26	811	Coles'	7.8	37	27.00	19
745	Salisbury	56.9	4	20.19	27	812	Davenport	0.5	49	30.76	15
75 =	BOOTHBY					813	Gilles East	3.2	46	15.37	33
751	Bragg	3.5	45	13.93	34	814	Highbury	16.9	24	40.07	9
752	Fisher North	25.0	16	29.32	16	82 =	WAKEFIELD(Part)				
753	Leabrook	13.5	29	13.92	35	823	Goyder (part)	17.9	21	47.05	5
754	Mitcham	17.7	22	17.96	28	824	Light North(part)	3.9	42	56.19	1
755	Norwood	24.6	17	11.28	38						
756	Unley	48.0	8	5.90	44						
77 =	HAWKER										
771	Ascot Park	30.2	13	8.17	43						
772	Fisher West	6.9	38	28.19	18						
773	Goodwood	126.5	1	2.24	50						
774	Hanson East	53.1	7	12.82	36						
775	Marleston	89.2	3	5.25	45						
776	Mitchell	30.4	12	16.34	30						

Source: Author's reprocessing of data supplied by State Electoral Dept., Adelaide.

- (2) The clockwise succession of calculations involves multiplying the number of movers in each class by its allocated cosine value. These cosine-mover products are then summed and recorded against the 'beginning class'. The process is then repeated, beginning with the next class to the right of the first, until after ninety clockwise rotations (iterations) all classes have recorded a "sum of cosine-mover products".
- (3) The directional class which records the highest 'sum of cosine-mover products' is the dominant direction of outmovement.

The procedure for accumulating the cosine-mover products for each of the ninety angular classes comprising the set, is summarized in the following equation.

$$\sum_1^n C.M = X_1 \text{Cos}\theta_1 + X_2 \text{Cos}\theta_2 + \dots + X_n \text{Cos}\theta_n \quad (E7.1)$$

where

- C.M represents the cosine-mover product for each angular class
- X represents the number of out-migrants in each angular class taken in clockwise order
- θ represents the central value for each angular class ($\theta_1 = 0$ degrees in every iteration)
- n is the number of angular classes (1 is the first class in the set).

In the present case, where $n = 90$, the procedure was applied to the existing data by computer. The result is summarized in the accompanying Table 7.2 which shows in column 1 for each subdivision the directional bearing which produced the highest sum of cosine-mover products and was thereby selected as best representing the dominant direction of out-migration, in this case with reference to the C.B.D.

7.3.4 Index of Concentration

This was derived as an objective indicator of the extent to which outmovements from a given origin are concentrated into a narrow or wide range of directions taking into account the volume of flows. Consider the following hypothetical cases representing the two possible extremes of directional concentration. Firstly, the most concentrated outflow possible occurs when all the movement takes place in a single angular class. Secondly, if movement occurs uniformly in all directions so that all angular classes carry flows of the same size the concentration is at a minimum of zero (see Jones 1968, p.63 and Waterman, 1963, p.101). A suitable index therefore will register a maximum in the first case and zero in the latter.

One such index is readily available utilizing the cosine-mover product derived from application of equation, E7.1 (p.219). In the first hypothetical case, maximum concentration, the grand total sum of all cosine-mover products from all ninety rounds, and ignoring signs at this stage only, happens to be $57.4N$, where the sum of the cosine values alone of all 90 angular classes is 57.4, and 'N' is the total number of out-migrants. If signs were not ignored at this stage the grand total would be zero in every case because iterations with positive sums are exactly matched by those with negative totals. Each of the 89 directional classes with zero movers generates cosine-mover products of zero, and the single remaining class, which contains movers, generates the highest possible sum of cosine-mover products. In the second hypothetical case, with uniform movement in all directions, the sum of products at each round will be zero because positive and negative products exactly cancel each other (application of E7.1) thus

identifying no dominant direction. The grand total summation of the ninety iterations, ignoring signs only at this stage would also be zero. The value 57.4 and 0 therefore represent the two possible extremes of the index of directional concentration as applied in this case. If so desired, results could be expressed as a percentage of the absolute maximum, which happens to be 57.4 in this example because of the choice of ninety as the number of angular classes. Use of the percentage would provide a universal index for comparison regardless of the particular number of angular classes selected.

The following is the procedure for obtaining the Index of Directional Concentration (I_c) of outmovement from each individual origin area. It involves dividing the grand total sum of cosine-mover products (ignoring signs) by the total number of out-migrants.

$$I_c = \frac{\sum_i^n (\sum_i^n C.M)}{N} \quad (E7.2)$$

where

- C.M is the cosine-mover product for each angular class
 (as in E7.1)
- N is the total number of out-migrants for the origin
 area (equal to the sum of all 'X' in E7.1)
- n is the number of angular classes set up in the
 particular programme ('i' is the first class in
 the sequence).

In calculating the grand total the signs of the earlier totals are ignored, otherwise the result for I_c would be zero in all cases.

The results of applying this procedure to the present case are

shown in Table 7.2, column 3. The scoring of subdivisions on the Index of Directional Concentration may be compared with the much cruder measure of dispersement used earlier, namely the number of active links (see Table 5.2). An objective statistical comparison is made difficult by firstly, the skewed distribution of real values, and secondly, the large number of tied rankings in the active links. Kendall's tau was selected as a suitable correlation coefficient enabling comparison whilst allowing for the distortions. This confirmed the expected moderately strong, inverse relationship ($\tau = 0.28$, highly significant at .003). The tendency therefore is for a high index of directional concentration to occur in subdivisions with a relatively low number of active links while those with low indices of concentration rank high in active links. The index, however, is a much more sensitive indicator of dispersement as shown by the fact that it succeeds in highlighting differences in directional concentration between areas with the same number of active links. Reference to the tables show for example that although the following four subdivisions each have 45 active links their respective indices of directional concentration are widely different: Adelaide (711) 4.95, Florey West (712) 16.16, Fisher North (752) 29.32 and Elizabeth (741) 48.98. Discussion of spatial and statistical relationships between the index of concentration, direction of out-movement and distance from the C.B.D. is kept until a later section (7.4.3).

7.4 THE CASE STUDY

Discussion so far in this chapter has covered previous studies on direction of intra-urban migration, the problems of measuring directional characteristics of movement and the development of two indices especially for that purpose in the present study. The following discussion centres on presentation of the directional aspects of intra-urban migration in the Adelaide Statistical Division.

7.4.1 The data and some general impressions

The data upon which this presentation is based have been discussed in part already. Their source, collection, processing and limitations were examined in some detail in Chapter 3. Successive chapters have examined separately different characteristics of aggregated intra-urban migrations of electors emanating from electoral subdivisions.

The basic data for this section and their locations in this text are here briefly summarized.

- (1) Direction (reference North) between all centroids in the A.S.D. (See Appendix F)
- (2) Direction (reference C.B.D.) between all centroids in the A.S.D. (See Appendix G)
- (3) Number of electoral transfers between subdivisional origins and destinations, A.S.D., 1970-71 (See Table 5.1)
- (4) Summary cross-tabulation for A.S.D. showing the number of electoral transfers by distance and direction (See Appendices

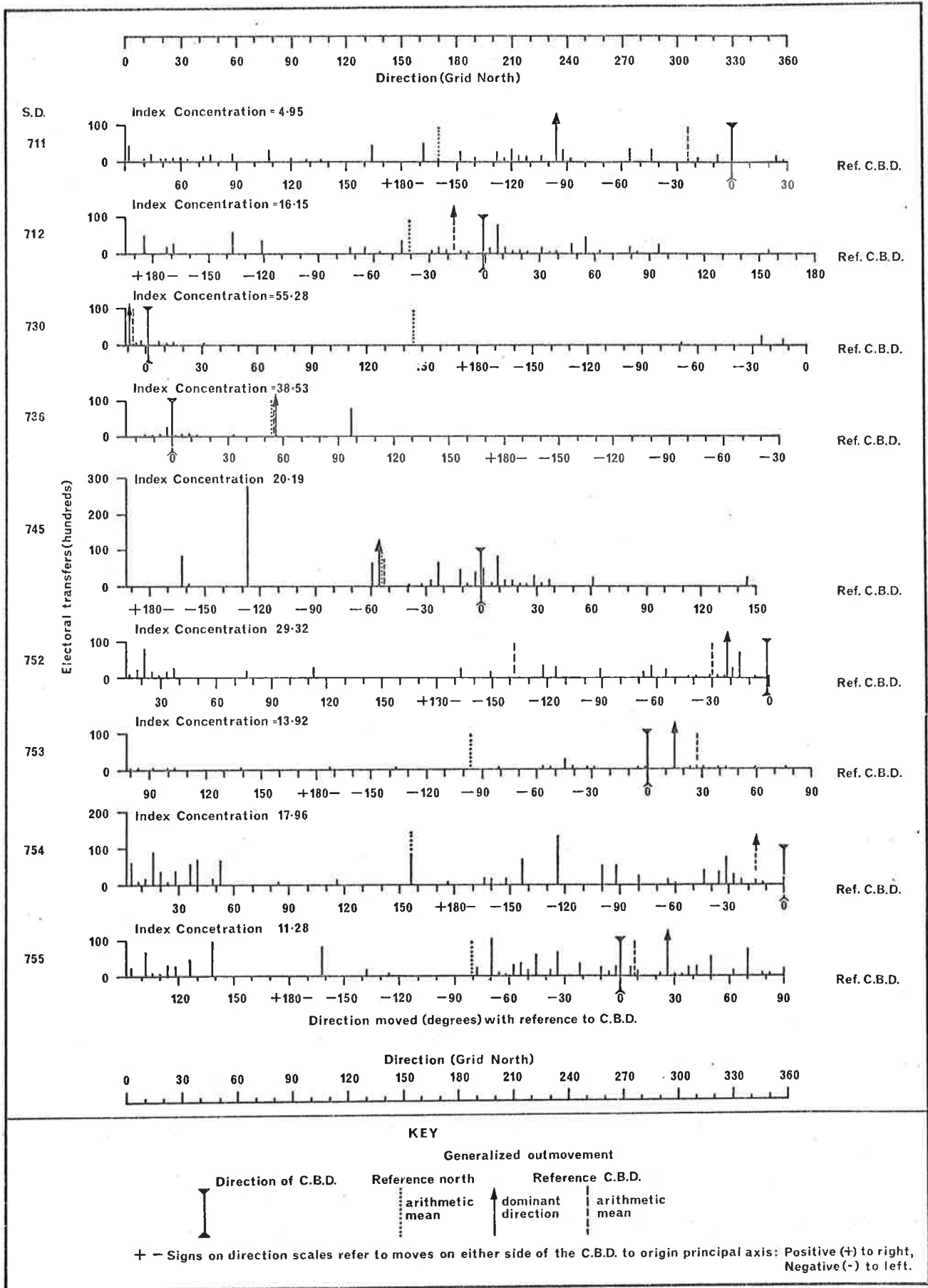

FIG. 7.2 Graphs for selected subdivisions showing numbers and directions of intra-urban outmigrations.
Source; Author's reprocessing of data from State Electoral Dept., Adelaide S.A.

H and I).

Processing of data on direction of outmovement involved the preparation for each subdivision of a table showing the number of transfers in each of ninety directional classes. Although these tables are not included in this thesis because of their bulk, Table 7.1 is in the same format but is a summary for the whole Adelaide Statistical Division. The subdivisional information does appear in diagrammatic form in Appendix D where use is made of concentric circles to show distance from each centroid, and of lines of proportional thickness and length to show the number of movers in each directional class and the distance they move. A selection of these diagrams is presented in this chapter (see Fig. 7.3) as is also a much reduced composite for the whole Adelaide Statistical Division (see Fig. 7.4). The dominant direction of outmigration and the index of directional concentration for each electoral subdivision are both shown in Table 7.2.

A useful, if subjective, first general impression of directional aspects of outmigration may be obtained from an examination of the accompanying Figures 7.2 and 7.3. These represent similar information in two different graphic forms, linear and circular, for a selection of nine subdivisions. The nine subdivisions selected are the same ones used in the cross tabulation of annual rates of net migration and population turnover (see Fig. 4.6 and Table 4.4) and also in the analysis of movement volumes (see Fig. 5.2).

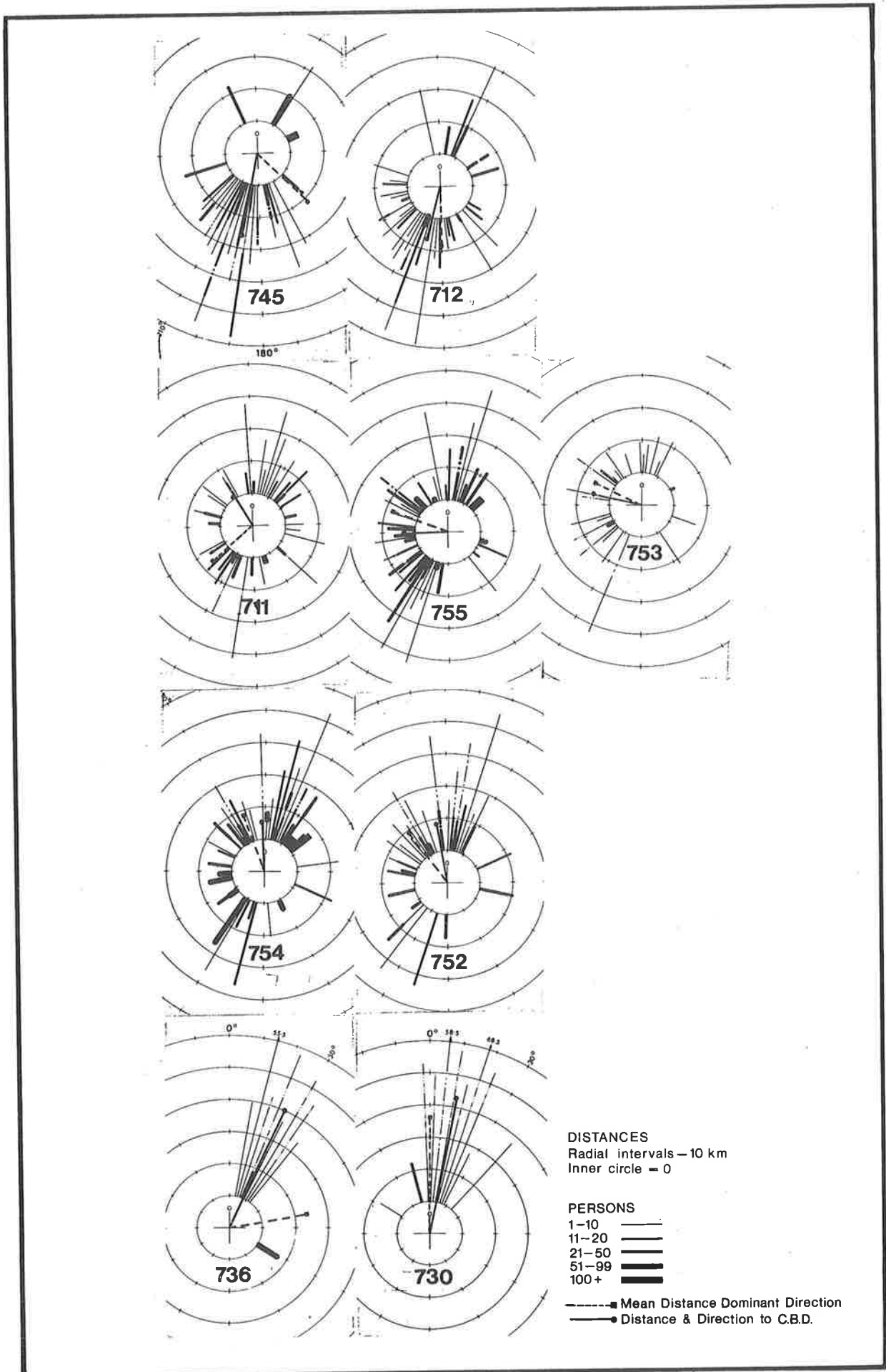

FIG. 7.3: Diagrams for selected subdivisions showing volume, distance and direction of intra-urban migrations.
 Source: Author's reprocessing of data from State Electoral Dept., Adelaide, S.A.

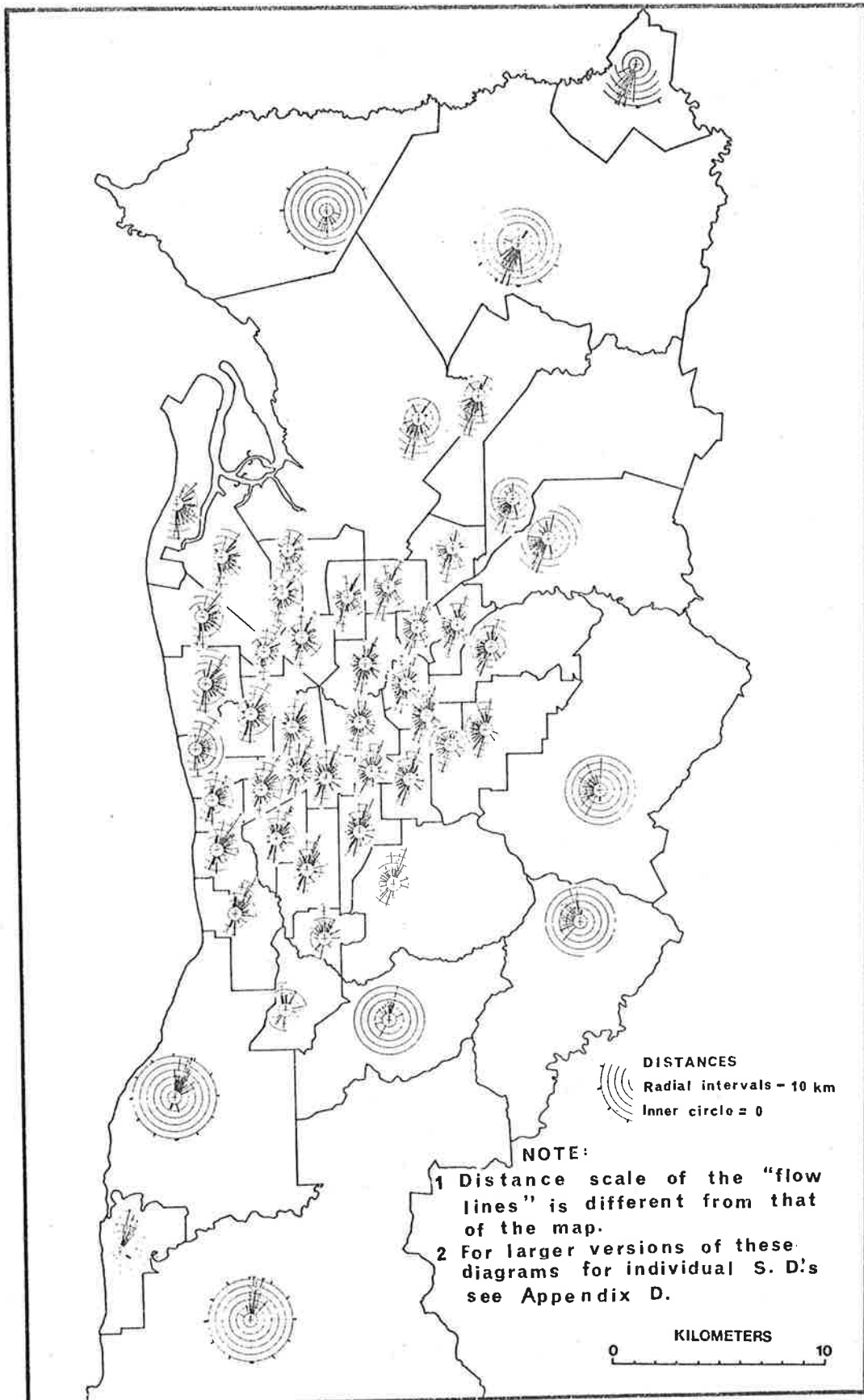

FIG.7.4. Composite diagram of Adelaide Statistical Division showing for each electoral subdivision the volume, distance and direction of outmigrations, March 1970 to June 1971.
Source: Author's reprocessing of data from S. E. D.

Inspection of the graphs in Figure 7.2 yields impressions on both the positioning of modal flows and results of alternative measures of central tendency. It is clear that in the case of S.D.s 730 and 745 a single flow dominates a restricted directional range of flows. In contrast S.D. 711 and to a lesser extent S.D. 712 display a wide, relatively even spread of outflows with no outstanding single dominant. The remaining five subdivisions possess varying degrees of directional bias between the two extremes described earlier. S.D. 755 has a fairly even spread over about two-thirds of the possible range while others have a single dominant flow (for example, S.D.s 736 and 753) or multiple dominants (for example, S.D.s 752 and 754).

The graphs have been marked to show the results of the following three attempts to determine a dominant direction of outmovement: firstly, a simple arithmetic mean with reference to grid north, secondly a simple arithmetic mean with reference to the C.B.D. and thirdly dominant direction derived from the cosine application described earlier in this chapter. In five of the nine cases all three measures either coincide or are within a couple of degrees. In the other cases the grid north mean has failed to identify a central outmovement class. In these cases improvement has resulted from use of the C.B.D. as reference node. The cosine-based dominant direction varies in its relative placement (up to 70 degrees in S.D.711) in comparison with the C.B.D.-based mean but in each case appears subjectively better positioned as a generalizing description of outmovement.

The circular graphs of Figure 7.3 have been placed in approximately correct relative geographic locations with separate reference lines indicating the direction of the C.B.D. and the calculated dominant outflow. Probably the most outstanding directional impression is of a variation with distance from the C.B.D. From the inner suburbs (S.D.s 711 and 712) most movement is outward in all directions, from the middle suburbs (S.D.s 753, 754 and 755) movement also covers a wide range but appears to be mainly laterally across suburbs and from the outer suburbs (S.D.s 730, 736 and 745) movement is mainly toward the C.B.D. While S.D. 754 also fits the latter pattern it has in addition a number of strong outward flows. The accompanying diagram (see Fig. 7.4) is a composite made up from the individual subdivisional elements so reduced that the general over-all impressions of outmovement patterns stand out. They are in substantial agreement with the trends just described.

A graphic representation of the frequency distribution of directions of outmovement for the whole Adelaide Statistical Division is shown in Figures 7.5/1 and 7.5/2 firstly with reference to grid north and secondly to the C.B.D. as reference node. The distribution in the first graph is bi-modal with the peaks representing flows to the north-north-east (centred on 14°) and a rather stronger one to the south-south-west (centred on 194°). The troughs occur to the east (centred on 96°) and west (centred on 278°) emphasizing the fact that the directional distribution is remarkably symmetrical with a pair of almost equal and opposite minima on an axis oriented west-north-west to east-south-east.

This is at right angles to the axis about which the maxima occur. Not surprisingly the spatial distribution revealed by this analysis is a close approximation of the shape of the Adelaide urban area thereby suggesting the obvious that in the overall pattern people are moving in volumes and directions according to the existing distribution of developed areas. Such a crude general impression has arisen apparently in spite of the considerable spatial differences discussed in Chapter 4 in rates of net migration and population turnover.

Direction of outmigration for the entire study area with the C.B.D. as reference node has also been plotted using the same transfer data (see Figure 7.5/2). For the purpose of plotting, it was assumed that the already determined Population Centre of Gravity (P.C.G.) was the point from which total outmovement effectively emanated (see Section 4.6.2). The direction of the C.B.D. was marked on the graph therefore according to its position relative to the P.C.G. (173.9 degrees). The directional distribution of outmoves is in this case unimodal, centred almost symmetrically about the C.B.D. The suggestion emerges that, disregarding the relative location within the city of any particular origin, the greatest proportion of intra-urban moves is directed toward the C.B.D., with successively smaller proportions directed laterally and away from the C.B.D. The smallest directional class is centred on 134 degrees showing that there are slightly greater numbers in the more extreme angular classes directed away from the C.B.D. The finding that the overall directional tendency is toward the C.B.D. seems at variance with

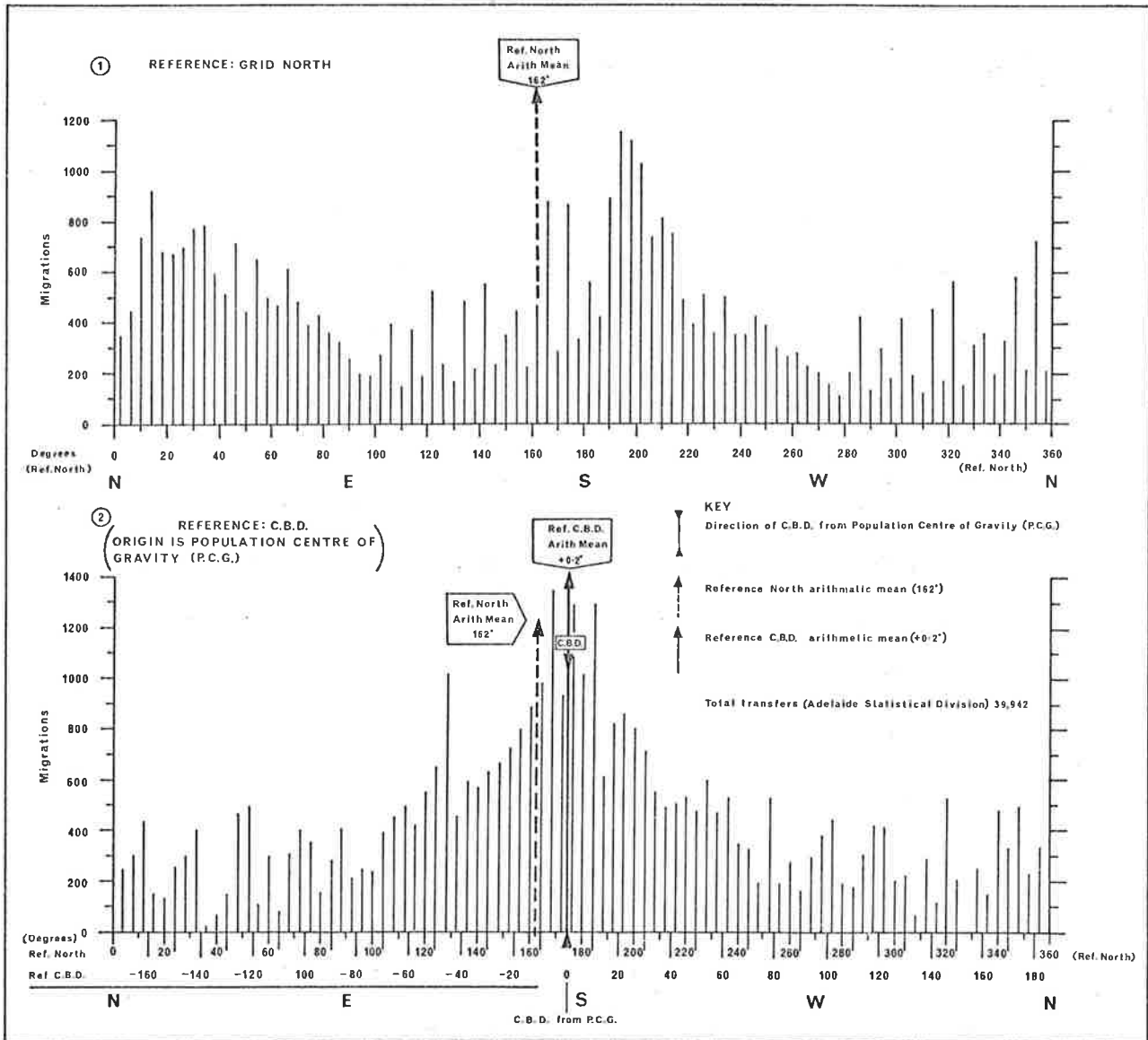

Adams (1969, pp.315 and 320) who showed from his Minneapolis sample arranged in concentric rings that out-movement was dominant and "people close in moved out". This departure therefore calls for further clarification.

7.4.2 Dominant direction of outmovement

The general descriptions just concluded further emphasize the desirability of achieving a clearer, objective generalization of directional trends in Adelaide's intra-urban migration. This therefore is the appropriate place to utilize the technique described in section 7.3.3. for determining a "dominant direction" of outmovement for each electoral subdivision. However, two important notions which are to be used in the presentation of the results should first be defined. The first involves Adams's division into three broad classes of the direction of movement with respect to the C.B.D. as orientation node. In order to ensure objectivity in application of these classes to the present study the criteria employed are those set out by Whitelaw and Gregson (1972, p.11). The line joining the point of origin to the C.B.D. is the principal axis with a bearing of zero degrees, and moves made to either side of this reference are measured positively. Classes are determined as follows: moves toward the C.B.D. are those with angles of less than 45 degrees, lateral moves have angles from 45 degrees to 135 degrees and moves away from the C.B.D. are at angles greater than 135 degrees. The second definition involves the designation within the study area of three broadly concentric zones termed respectively inner,

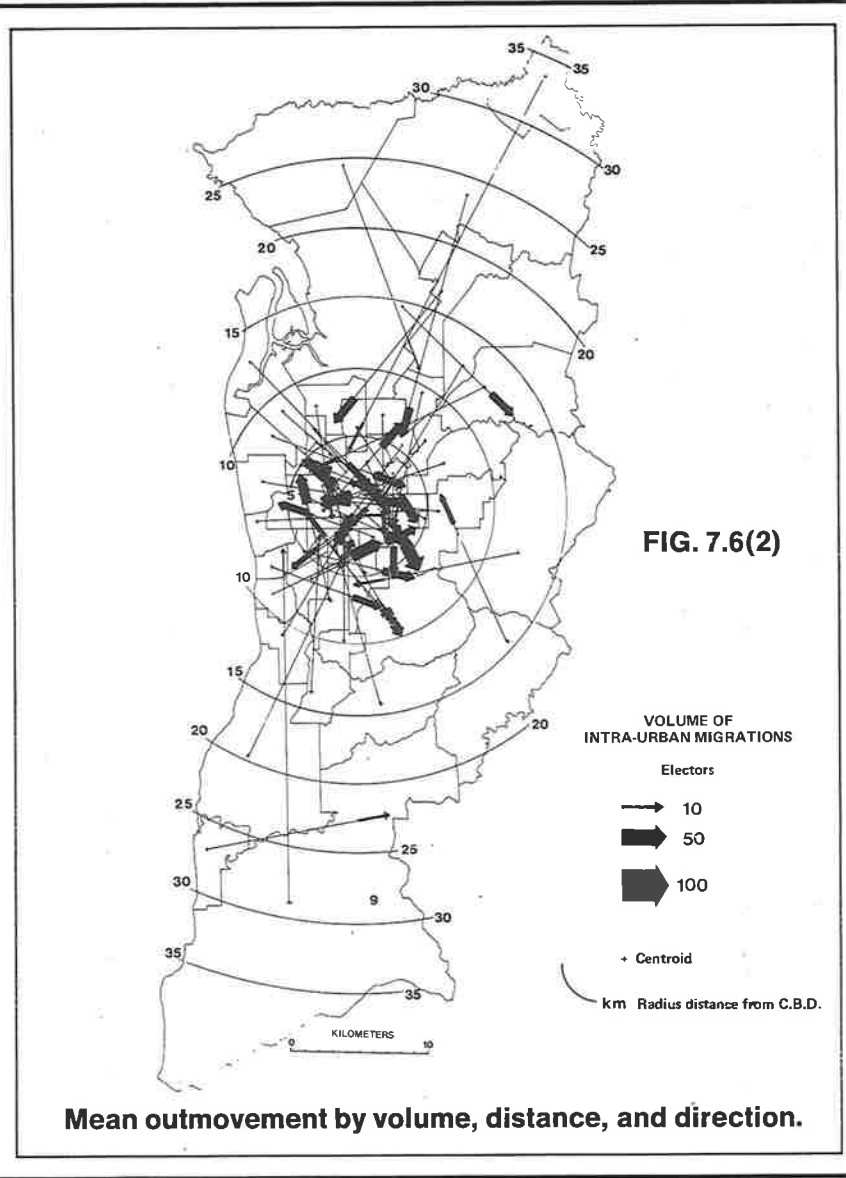
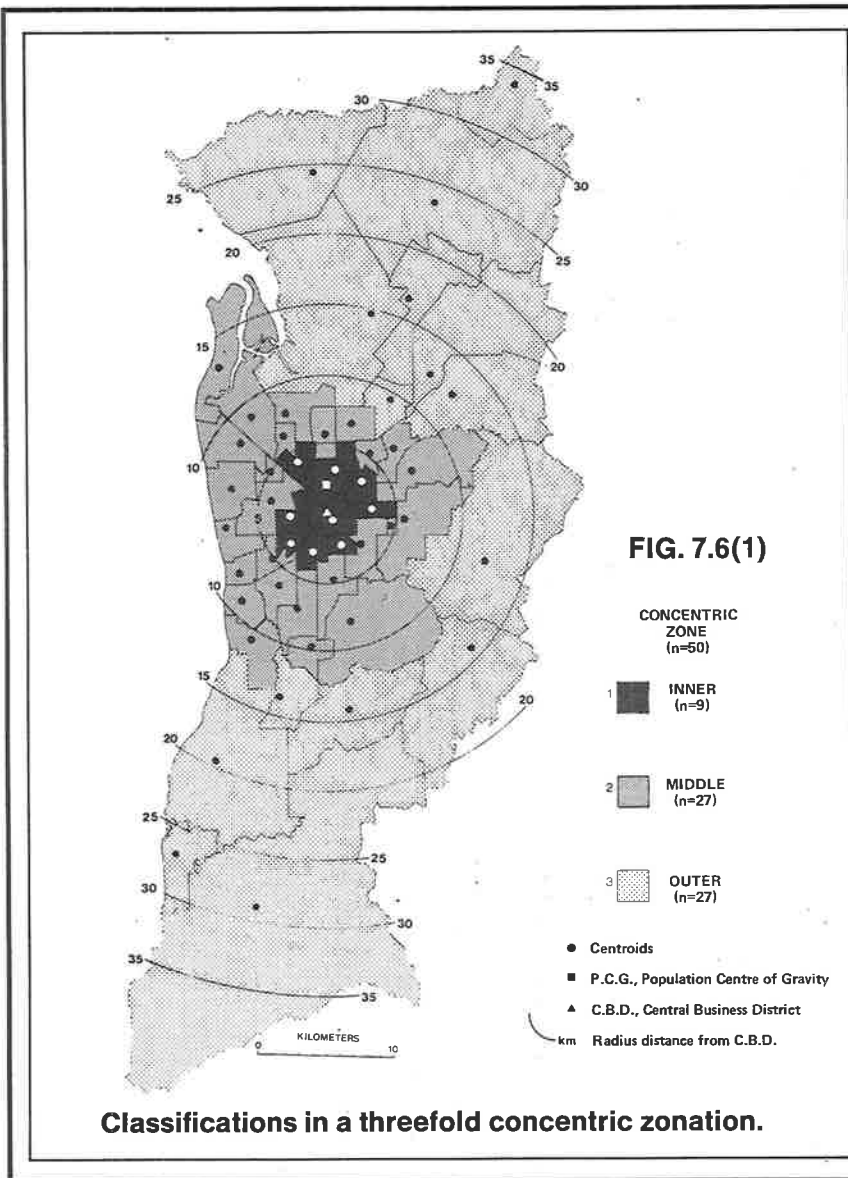

FIG. 7.6: Maps showing for each electoral subdivision in the Adelaide Statistical Division (1) classification in a threefold concentric zonation (2) the mean outmovement by volume, distance, and direction. Source: Author.

middle and outer. Electoral subdivisions have been allocated in such a way that each assembled zone matches spatially as closely as possible the three zones of arbitrarily assigned local government areas in Figure 3.2. The concentric zones of electoral subdivisions are shown in the accompanying Figure 7.6/1.

The results of applying to each subdivision the special technique for determining the dominant direction of outmovement are listed in Table 7.2 and also incorporated into a proportional arrow map (see Fig. 7.6/2). The single arrow from each centroid is scaled to represent both mean length of move and mean volume of movers per active link in addition to showing the dominant direction of outmigration. Several features of importance do emerge from the map even though the superimposed arrows appear somewhat confused. These features are mentioned here briefly and will be taken up again in later discussion. Firstly, relatively few of the generalized flows are actually directed towards the periphery, a bigger proportion is directed inward toward the C.B.D. while many flows are lateral or cross suburban. Secondly, the ends of the vectors of mean flow (shown on the map as arrowheads) are to be found mainly in the middle suburbs; for example, 32 of the 50 flows end within 5 Km of the C.B.D. and 15 more end inside the 10 Km radius line, leaving only 3 mean flows to end beyond that distance of the C.B.D. This gives further weight to a claim made in earlier sections that most movement activity is occurring in the inner and middle suburbs.

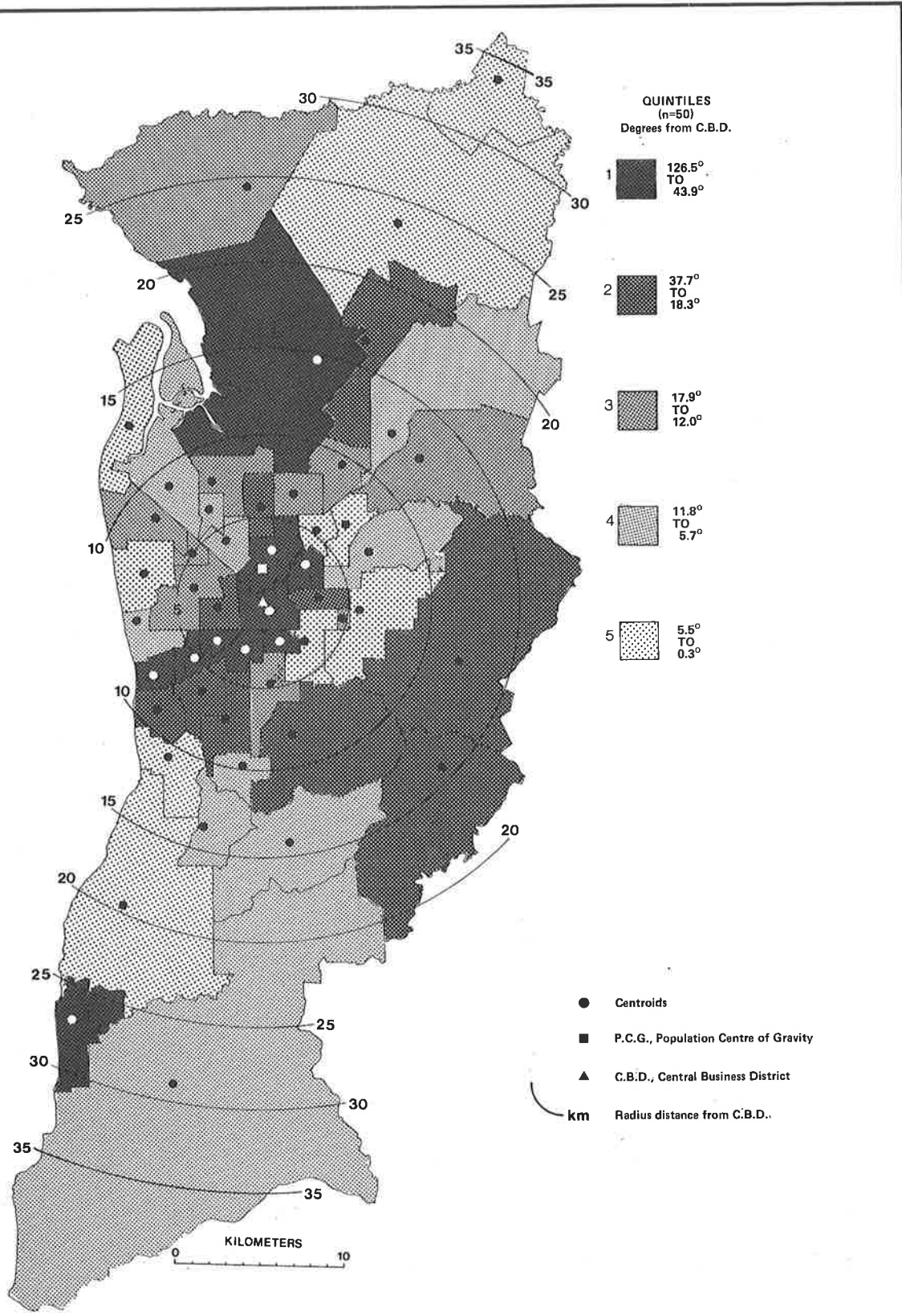

FIG. 7.7: Map showing for each subdivision the quintile classification of dominant direction of out-movement with the C.B.D. as orientation node.

Source: Author's reprocessing of data from State Electoral Dept., Adelaide, S.A.

Subdivisions with similar dominant directions of out-movement have been grouped together into quintiles (see Figure 7.7) for choropleth representation of the spatial distribution of directional trends measured with reference to the direction of the C.B.D. There is evidence of both concentric and sectorial arrangement of similarly classed areas. Areas in the top quintile show the clearest trend for movement to be directed away from the C.B.D. with high angles of movement ranging from 43.9 to 126.5 degrees. This class comprises mainly a contiguous block of central and inner suburban subdivisions. Adjacent to these on their outer edges are four separate areas of the next quintile with smaller angles of out-migration (S.D.s 714, 755, 776 and 771, and 786). Despite this evidence of concentricity the notion of a nicely graded sequence of decreasing angles of out-movement with increasing distance from the central city is hard to confirm even in this subjectively selective manner. There are for example two widely separated, isolated areas of first quintile ranking - in the south S.D.736 (Moana) and to the north S.D.745 (Salisbury). These appear as "erratics" in the landscape whether the distribution is viewed as concentric or sectorial in arrangement. Salisbury need not be considered as totally alone in its directional trend as the areas adjacent on its east show some related gradation. This recalls evidence discussed in chapters 5 and 6 that transfer in the Salisbury-Elizabeth area formed a strongly interconnected movement system. The map (Fig. 7.7) shows that the inner core of first quintile status extends south-westwards from the C.B.D. to S.D. 793

(Hanson South). This extension is associated with another distinct system also discussed earlier and the data suggests a directional gradation southward through S.D. 792 (Gleneig). The above two cases are cited as evidence of the possible effect on direction of out-movement of multiple nucleation (Harris and Ulman, 1945) in the morphology of urban Adelaide.

Special examples of sequential gradations in directional trends can be traced from the C.B.D. in the following three directions. The first runs south, the second westward to the coast and the third north and north-west to S.D. 804 (Semaphore). Although this might be taken as evidence of concentric zonation in the direction of outmovement it must be noted that there are also some sharp contrasts. For example, immediately north-west of the C.B.D. and adjacent to the main road to Port Adelaide is a long sector uniformly of fourth quintile status (S.D.s 785, 805 and 803). Furthermore there are two areas with fifth quintile status lying adjacent to the inner core first quintile (north-east S.D.s 713, 813 and south-east S.D.s 751, 812).

In summary, the main impression to be gained from Figures 7.6 and 7.1 is an unquantified one that there is a negative relationship between direction moved and the distance of origin from the C.B.D. This notion, propounded by Adams (1969), needs further testing in the present case.

A test of directional bias used by Adams (1969, pp.319-321) involved graphing the percentage cumulative frequency of move-

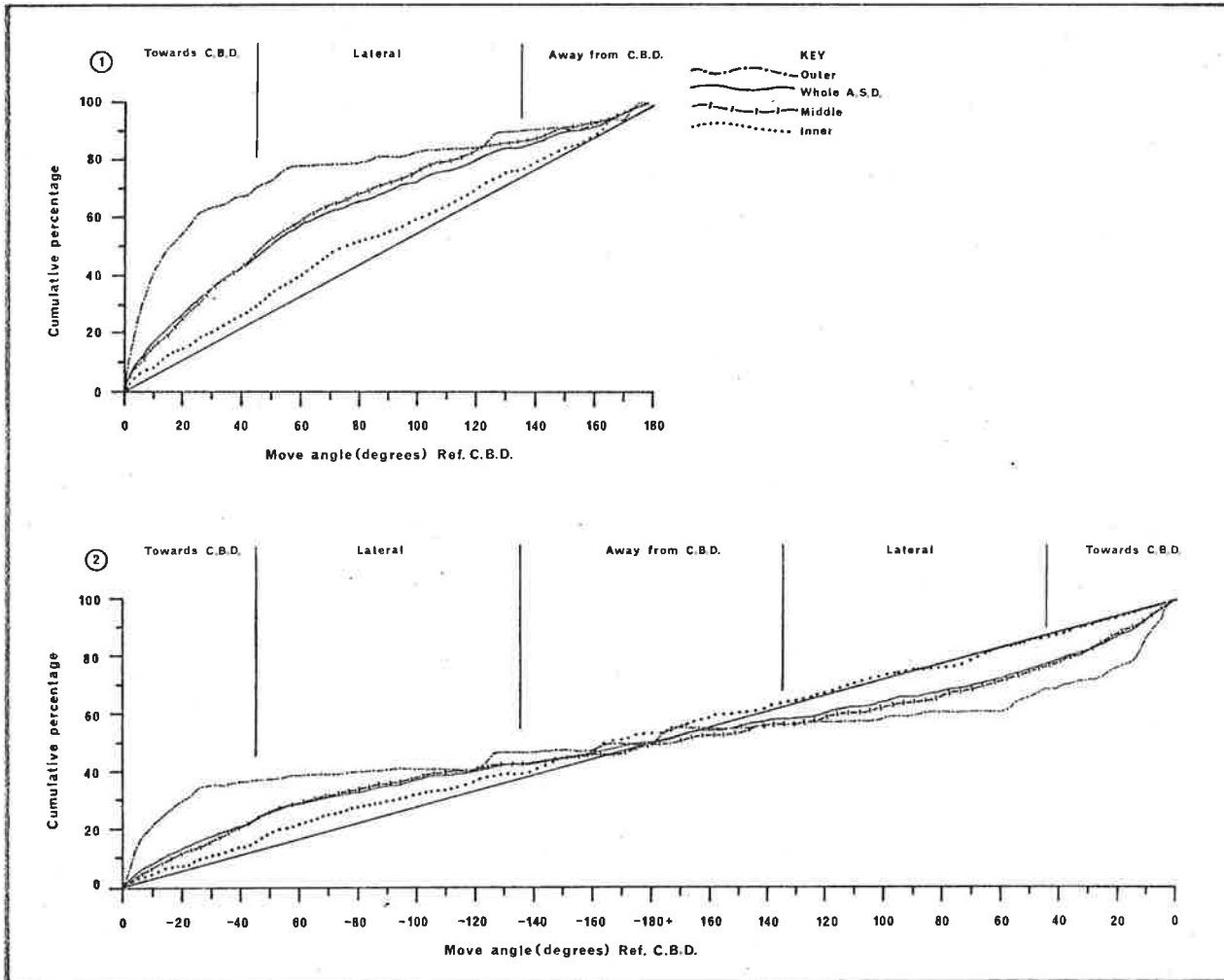

FIG. 7.8 Graphs showing percentage cumulative frequency of direction of outmoves (C.B.D. as orientation node) Adelaide Statistical Division; (1) range 0 to 180 degrees and (2) 0 to 180 and -180 to 0 degrees
 Source: Author's reprocessing of data from State Electoral Dept. Adelaide, S.A.

angles with the C.B.D. as orientation node. He claimed that if movements were directionally unbiased (random) all angles from zero to 180 degrees would be uniformly represented and thus graphically the cumulative frequency distribution would be shown by "a straight line trending upward to the right" (Adams, 1969, p.320). Although this method of measuring spatial bias has been criticized (Brown and Holmes, 1971, p.106) as limited in comparison with more elaborate techniques it is nonetheless useful (see Whitelaw and Robinson, 1972, p.188). The accompanying graphs (see Figure 7.8) result from application of Adams's technique to the Adelaide data.

A threefold division of the directional range as used by Adams and defined by Whitelaw and Gregson (1972, p.11) has been described already at the beginning of this section. For the purpose of discussion the Adelaide Statistical Division has been divided into three arbitrary concentric zones known as inner, middle and outer as already shown in Figure 7.6/1. In both graphs of the accompanying Figure 7.8 there are four data lines representing the percentage cumulative frequency of electoral transfers during 1970-71 by direction with reference to the C.B.D. One line summarizes the entire Adelaide Statistical Division, while the others each represent one of the concentric zones already defined. The first graph shows that 47 per cent of all moves were directed toward the C.B.D. while 37 per cent moved laterally and only 16 per cent were directed away from the C.B.D. This demonstrates clearly a considerable directional bias toward the orientation node. The largest divergence from the line of

"random distribution" on the graph occurs at about 62 degrees and is about 21.5 per cent, much greater than those published by Adams (1969, p. 320) and more like those for selected individual Melbourne suburbs (see Whitelaw and Robinson, 1972, p.188).

It is interesting to note the following distinct geometric differences displayed by out-movements from the three concentric zones. The transfers from the inner zone most nearly resemble a uniform-random distribution. The middle zone of suburbs provides over 60 per cent of all transfers, displays more directional bias than the inner zone and, not surprisingly, closely approximates the graphed line representing the entire study area. The outer suburbs show a very strong directional trend toward the C.B.D. with 70 per cent of transfers headed in that direction. The directional distribution of transfers from each of the three concentric zones is further summarized in the accompanying Table 7.3

TABLE 7.3

Three concentric origin zones, showing percentage of transfers from each, directed toward, away from or laterally, with respect to the Central Business District (C.B.D.)

Concentric Zone of Origin	Direction of Destination with Reference to the C.B.D.		
	Toward 0° to 45°	Laterally 46° to 135°	Away from 136° to 180°
Inner (100%)	30	47	23
Middle (100%)	48	39	13
Outer (100%)	70	20	10
Whole Adelaide Stat. Division (100%)	47	37	16

Source: Author's reprocessing of data from State Electoral Dept., Adelaide.

An important feature which emerges from the foregoing is that outmovements from any given origin area are likely to be ranged across most of the possible directional spectrum. The particular mix in any specific origin area depends among other things upon the location of that area within the city; for example, in inner areas lateral movements and those away from the C.B.D. are both at a proportionate maximum. With increasing distance of the origin from the C.B.D., movements toward it become proportionately greater while those directed laterally or away from the C.B.D. become progressively less important numerically.

Although the Adams technique ignored which particular side of the C.B.D. reference line transfers occurred it is a logical possibility that directional bias could differ between the two sides. In order to test this aspect in the present study angles measured with the C.B.D. as orientation node were designated as positive if on the right of the principal axis and negative if on the left of the principal axis. Figure 7.8/2 is a percentage cumulative frequency graph comparing the distribution of both the positively and negatively directed electoral transfers. It is clear that the bias to lateral movement is a little greater in the negative (left hand) transfers than the positive. Translated into practical spatial terms over the whole city this implies, for example, that residents in the southern suburbs tend to show a slightly greater preference for movement on the western side, the eastern residents tend to prefer movement south rather than north, that northern residents tend to prefer eastern oriented movement, that western residents show a slight preference

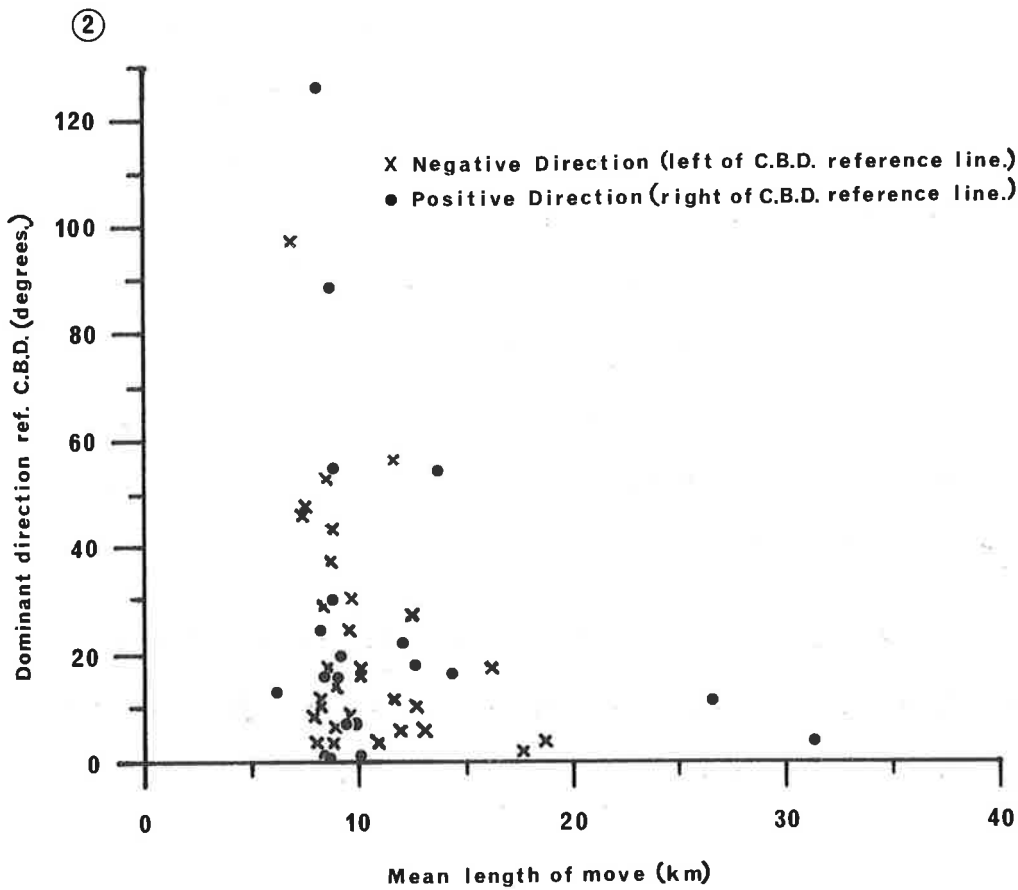
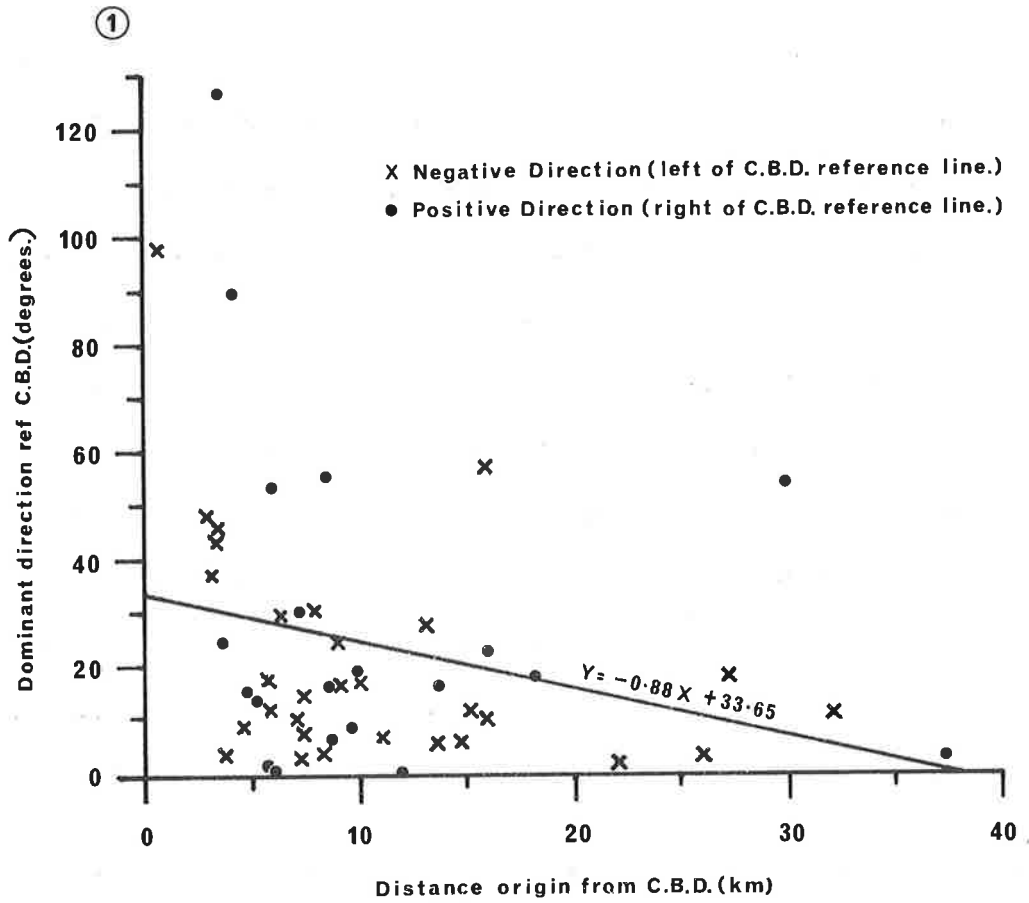

FIG. 7.9 Graphs comparing (1) distance of origin from C.B.D. and (2) mean length of outmigration with dominant direction of outmovement
 Source: Author's reprocessing of data from State Electoral Dept., Adelaide S.A.

to northern movement. Given the overall elongated shape of the urban area and the concentration of growth in the south-west and north-east, as described in Chapters 3 and 4, it is most likely that the distribution results from a slight bias to the north and south respectively from these particular areas. The trend shown in the graph is slight and general to the whole city and whether true at the regional scale just described, can only be determined by similar analysis at the regional level. Such analysis, though practicable, is not appropriate here because it would take the discussion too far from the main line of argument, but is a worthwhile topic for further investigation.

Having established objectively that directional bias is present in the transfer patterns, and gathered an indication of its nature and extent, it is logical to examine the relationship of the calculated dominant direction of out-movement with other variables. Accordingly the concluding discussion of this section centres on an assessment of the level of correlation between the subdivisional distributions of dominant direction of outmovement and each of two measures of distance. The first correlation is with the distance of origin centroids from the C.B.D. and the second with the mean length of outmoves. These two sets of relationships are portrayed separately in the graphs of Figure 7.9/1 and 7.9/2.

Earlier discussions have indicated the likelihood of a negative relationship between distance of origin from the C.B.D. and the direction of outmovement with reference to the C.B.D. The

relationship (Fig. 7.9/1) is shown to be significant at 0.025 (df 48) with a low, inverse Spearman rank correlation ($R = -0.29$). On the other hand the relationship between mean length of move and the direction of movement is rather less strong ($R = -0.24$) and only probably significant. Therefore, both the distance of origin from the C.B.D. and mean distance moved, are similarly related to direction moved. It was shown previously (Fig. 6.4/2) that mean distance moved and distance of origin from the C.B.D. were themselves highly and significantly correlated (Pearson $r = 0.91$, df 48).

It was shown in Chapter four that the spatial distribution of population movement indices (population turnover and net migration) are related to distance of the origin from the C.B.D. This relationship was described quantitatively in Chapter six so that it is now possible to compare the relationships between movement indices, distance and direction of movement as set out in the accompanying Table 7.4

TABLE 7.4

Correlation coefficients between annual rates of population movement and distance and direction moved.

Index	Annual Rate	Distance of	Mean distance	Dominant	Index of
Annual	of popula-	origin from	moved	direction of	directional
rate	tion turn-	C.B.D.		outmovement	concentra-
	over				tion
Net	$r = -0.479$	$r = 0.467$	$R = 0.593$	$R = -0.263^{(a)}$	$R = 0.572$
Popula-	—	$r = -0.379$	$R = -0.400$	$R = 0.419$	$R = -0.356$
turnover					

(a) Probably significant at the 0.05 level. All other relationships are highly significant at better than 0.005 (df 48).

In the present context the relationships may be summarized as follows. There is a distinct but weak tendency for the direction of outmovement to be increasingly oriented toward the C.B.D. with increased distance of the place of origin from the C.B.D. This trend is paralleled by those between movement indices and distance in which net migration increases with distance from the C.B.D. while population turnover decreases. In addition the mean distance moved increases with distance from the C.B.D. For origin areas nearer the C.B.D. there is a weak tendency for the dominant direction of outmigration to be oriented away from the C.B.D. and to take place over relatively shorter distances.

7.4.3 Index of directional concentration of outmovement

As indicated earlier in this chapter, the measure of a dominant direction of outmovement did not of itself provide any information about the amount of circular spread of flows about the descriptive generalizing measure (see section 7.3.4). There is a strong possibility that origin areas which prove to have the same dominant direction of outmovement could have in fact important differences in the spatial disposition of their respective sets of individual outflows. It was in an effort to meet the need to identify and describe such differences that the Index of Directional Concentration was developed and applied as already described (see Section 7.3.4). The Index of Directional Concentration and the Dominant Direction of Outmovement for each electoral subdivision are listed in Table 7.2.

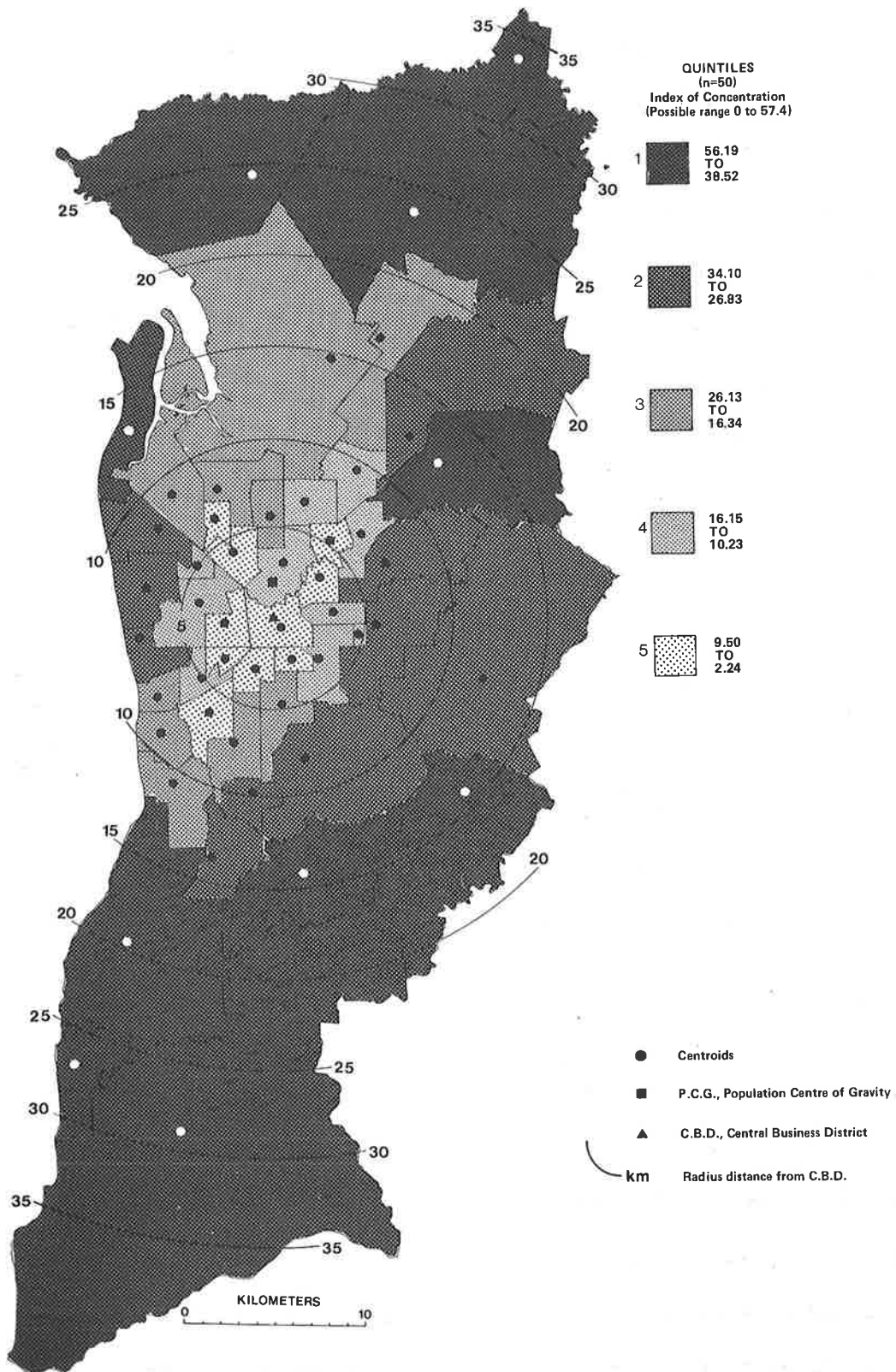

FIG. 7.10: Map showing for each subdivision the quintile classification of the index of directional concentration of outmigration.

Source: Author's reprocessing of data from State Electoral Dept., Adelaide, S.A.

A map has been compiled (see Fig. 7.10) using quintile classes to show the spatial distribution in the study area of the Index of Concentration. The map shows an obvious close positive relationship between the index and distance of origin from the C.B.D. This is confirmed in the graphic representation (see Fig. 7.11/1) in which a high Pearson's Coefficient of Correlation ($r = 0.83$) is highly significant at better than 0.005 (df 48). A few of the more interesting exceptions to the general distribution of subdivisions call for brief comment. Exceptions will be discussed, firstly, as areas where the Index of Concentration is rather higher than distance from the C.B.D. would suggest, and secondly, where the index is lower than distance would suggest.

Most of the areas with higher than expected index scores are on either the eastern or western margins of the urban area, hemmed in by the sea-coast (west) or the hills face zone (east and south-east). Examples are S.D.s 804 (Semaphore), 783 (Henley Beach), 782 (Hanson North), 814 (Highbury), 812 (Davenport) and 722 (Fisher East). Areas with lower scores on the Index of Concentration than distance would indicate are 744 (Playford), 745 (Salisbury) and 736 (Moana). Movers from these areas are spread over a greater directional range than those from other S.D.s a similar distance from the C.B.D., which is to suggest that movement patterns here are more like those of areas nearer the C.B.D. It can only be guessed as to whether the reasons lie in the nature and interests of the population or the existence of an older nucleation in the area or

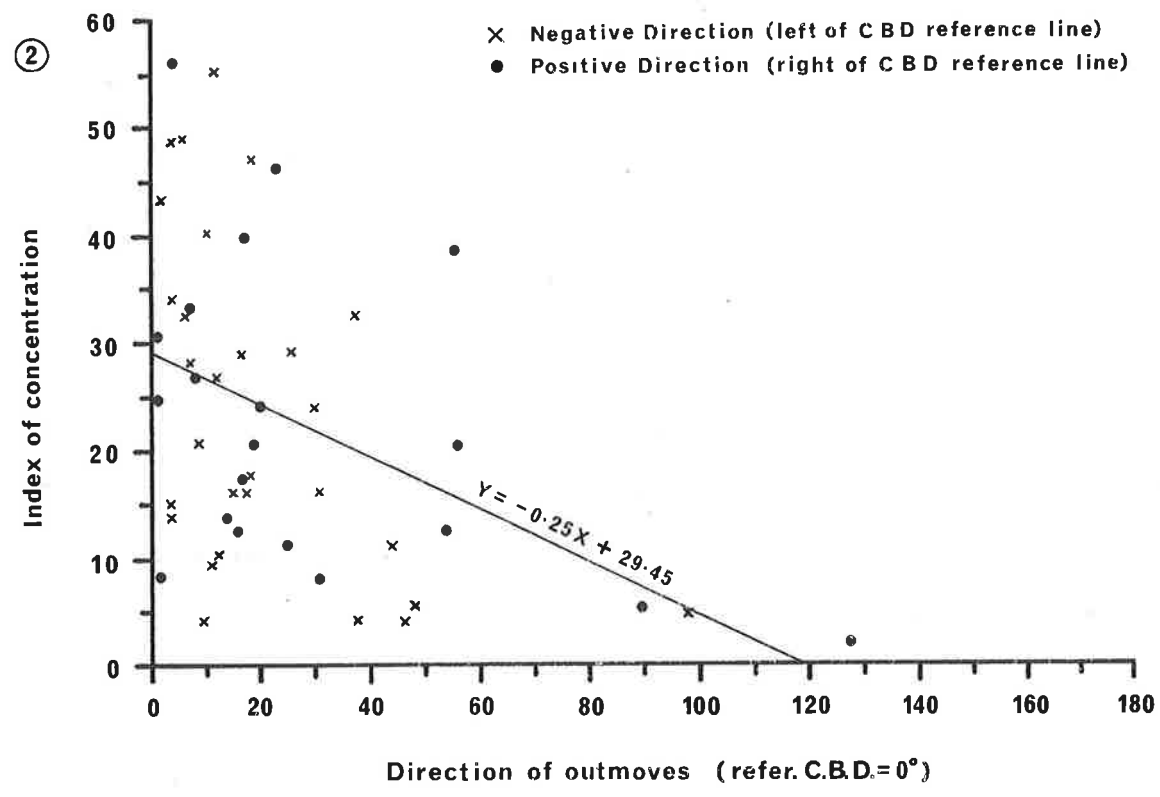
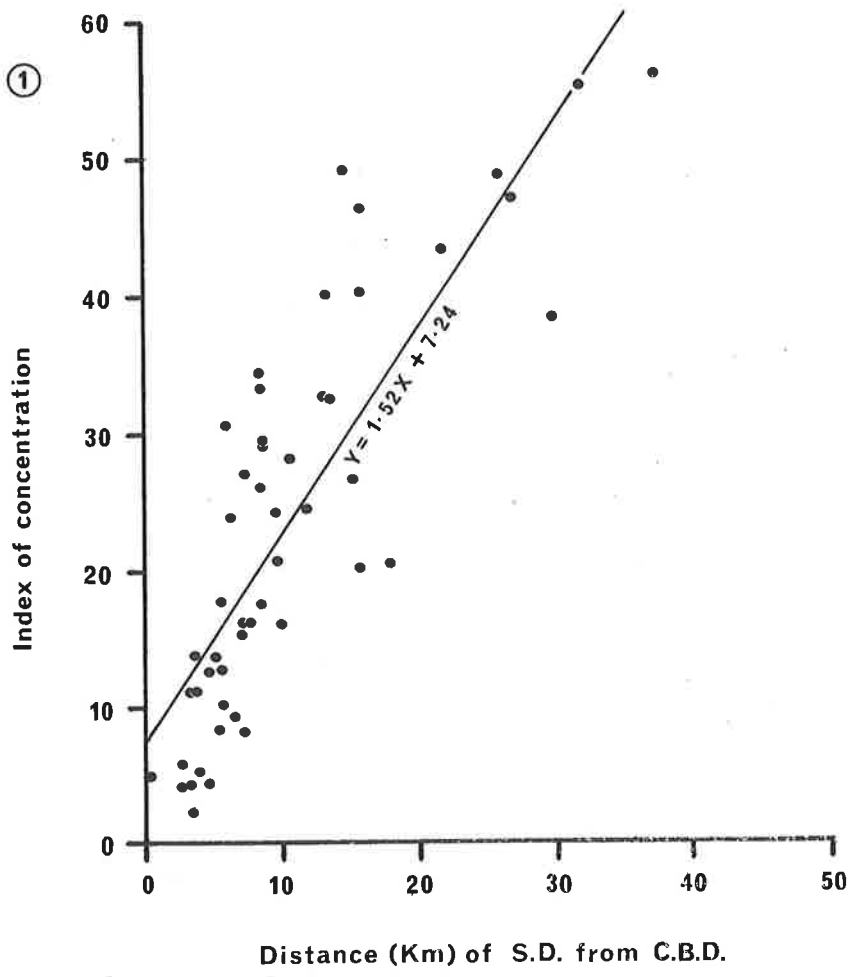

FIG 7.11 Variation in indices of concentration with (1) distance of origin from C.B.D. and (2) dominant direction of movement.

Source: Author's reprocessing of data from State Electoral Dept., Adelaide S.A.

the range of suitable housing opportunities in surrounding areas. It has just been demonstrated that a strong positive relationship exists between distance of origin from the C.B.D. and the Index of Concentration. A little earlier it was shown that there is a moderately negative relationship between distance from the C.B.D. and dominant direction of outmovement. It is appropriate now to examine the nature of the relationship between the Index of Concentration and the Dominant Direction of outmovement. This is portrayed graphically in Figure 7.11/2 where a strong negative Pearson's Correlation Coefficient ($r = -0.46$, $df 48$) is highly significant. This suggests that there is a strong likelihood of an area with a high angle of outmovement (such areas tend to occur near the inner city) having a low index of concentration while areas with low angles of outmigration (generally outer areas directed towards the C.B.D.) tend to have highly concentrated outflow patterns.

In both this and the previous section, most of the descriptions employed varied with distance from the C.B.D. In order to highlight the underlying co-variance with distance, use will be made here of the three concentric-zone classification of Adelaide as defined in Figure 7.6/1. Accordingly the accompanying Table 7.5 lists for each of the three zones and the whole study area a selection of population and elector characteristics intended to summarize the major points from this and preceding chapters.

TABLE 7.5

Selected population and elector movement characteristics for three concentric zones of electoral subdivisions in the Adelaide Statistical Division, 1970-71.

CHARACTERISTIC	CONCENTRIC ZONES						WHOLE AD. STAT. DIV. (50 S.Ds.)	
	INNER (9 S.Ds.)		MIDDLE (27 S.Ds.)		OUTER (14 S.Ds.)		Number	%
	Number	%	Number	%	Number	%		
1. Mean distance (Km) from C.B.D.	3.2	-	7.8	-	21.0	-	-	-
2. Area (S.Km) (b)	60.36	3.3	389.15	21.4	1368.02	75.3	1817.53	100
3. Mean area (S.Km) per S.D.	6.71	-	14.41	-	97.72	-	-	-
Population:								
4. Total Population (a)	131,050	15.6	512,526	60.8	198,762	23.6	842,338	100
5. Total electors (c)	73,246	15.6	295,877	63.2	99,340	21.2	468,463	100
6. Population density	2171.1	-	1317.0	-	145.3	-	463.5	-
7. Elector density	1213.5	-	760.3	-	72.6	-	257.7	-
Elector migration:								
8. Internal S.Ds	1944	17.5	6439	58.1	2705	24.4	11,088	100
(mean)	(216)		(239)		(193)		(222)	
9. Intra-urban	9321	23.3	24,598	61.6	6023	15.1	39,942	100
(mean)	(1036)		(911)		(430)		(799)	
10. Urban to rural	558	16.0	2030	58.0	908	26.0	3,496	100
(mean)	(62)		(78)		(65)		(70)	
11. Active links (Max.= 49 per S.D.)	424	19.9	1218	45.1	491	23.0	2,133	100
(mean)	(47.1)		(45.1)		(35.1)		(42.7)	
Movement rates:								
12. Elector deletions	17,322	22.6	46,335	60.5	12,934	16.9	76,591	100
(mean)	(1925)		(1716)		(924)		(1532)	
13. Elector additions	16,323	18.2	51,136	57.1	22,062	24.6	89,521	100
(mean)	(1814)		(1894)		(1576)		(1790)	
14. Population Turnover (% Annual)	-	19.8	-	14.4	-	13.2	-	14.6
(% Share)		(21.1)		(60.9)		(18.0)		(100)
15. Net Migration (% Annual)	-	-1.1	-	1.3	-	7.7	-	3.3
(% Share)		(-7.2)		(34.5)		(65.5)		(100)
Movement parameters:								
16. Mean distance (Km)	7.9	-	9.0	-	15.8	-	10.7	-
17. Dominant direction (degree Ref. C.B.D.)	58.1	-	15.7	-	18.8	-	24.2	-
18. Index concentration (max. possible 57.4)	6.0	-	21.1	-	39.2	-	23.5	-

Sources: (a) Census June 30, 1971, Australian Bureau of Statistics
 (b) Calculations by author
 (c) All other derived from data supplied by State Electoral Dept., Adelaide.

7.5 SUMMARY AND CONCLUSIONS

Although the inner zone of the Adelaide Statistical Division includes only 3.3 per cent of the territory it contains 15.6 per cent of both the population and of electors. It has an even greater share of all outmovement (about 20 per cent) experiencing a high turnover rate and a negative rate of net migration. The middle zone, with 21.4 per cent of the territory, houses 60.8 per cent of the population but 63.2 per cent of electors. Residential movement of electors is proportionately a little less than its share of population and electors, but the range of subdivisional movement-contacts is wider than for other zones. Although electoral deletions outnumber additions in the middle zone there is a low rate of increase through births (see Fig. 3.4/2). The outer zone contains more than three-quarters of the total territory of the A.S.D. but its residents comprise only 23.6 per cent and its electors 21.2 per cent of the total. Its share of internal moves is a high 24.4 per cent but between subdivisions a low 15.1 per cent. This is a zone of growth as shown by the high rate of 7.7 per cent per annum net migration, more than twice the A.S.D. average, which accounts for two-thirds of Adelaide's net migration increase. The growth is accompanied by a low rate of population turnover.

The distance and directional characteristics portrayed are generalized in the following terms. Outmovements originating anywhere in Adelaide are far from random in distance or direction, confirming one of the claims of Adams (1969). Moves which begin

in or near the inner city areas show only a moderate tendency to be directed away from the C.B.D. but a strong propensity for lateral destinations. Such moves are short and in aggregate are dispersed evenly over a large number of destinations through the full directional range. Such findings seem more in agreement with Clark (1970 and 1971) who claimed that central city regions generate spatially random movement patterns. Middle suburban areas of Adelaide give rise to the major proportion of all moves which in this case are longer and moderately concentrated directionally either toward the C.B.D. or laterally but still with a wide range of destinations. Transfers from outer suburbs are over longer distances and occur in narrow directional spans strongly focused toward the C.B.D. with fewer of the available destinations actually used.

It has been pointed out that because the same pattern of migrations can be produced by a number of processes "it is not possible to observe a pattern and infer back to its cause" (Johnston, 1971, p.295). The present study has so far said little about the characteristics of the population. This aspect will be related to movement patterns in the next chapter but without firm causal inferences. However it has been demonstrated clearly that some of the spatial aspects of aggregated intra-urban migration in Adelaide resemble those already described in the small range of existing case studies.

The techniques specially developed and outlined in this chapter for the objective description of directional characteris-

tics of movement have served their immediate purpose well. There is reason to believe therefore that these techniques could be profitably explored further so that improvements and refinements fit them for wider use. They involve basically simple procedures needing computer application to handle large amounts of repetitive processing.

REFERENCES

- ADAMS, R.B. (1969) 'U.S. Metropolitan Migration: Dimensions and Predictability'. Proceedings, Association of American Geographers, vol. 1, pp. 1-6.
- AGTERBERG, F.P. and BRIGGS, G. (1963) 'Statistical Analysis of Ripple Marks in Atokan and Desmoinesian Rocks in the Arkoma Basin of East-Central Oklahoma'. Journal of Sedimentary Petrology, vol. 33, pp. 393-410.
- BROWN, L.A. and MOORE, E.G. (1970) 'Intra-urban Migration: A Perspective'. Geografiska Annaler, Series B, vol. 52, no. 1, pp. 1-13.
- BROWN, L.A. and HOLMES, J. (1970) 'Search Behaviour in an Intra-urban Migration Context: A Spatial Perspective'. In Population and Migration in an Urban Context: A Spatial Perspective, Meetings of Population Association of America.
- BROWN, L.A. and HOLMES, J. (1971) 'Intra-urban Migrant Lifelines: A Spatial View'. Demography, vol. 8, no. 1, pp. 103-122.
- CAPLOW, T. (1949) 'Incidence and Direction of Residential Mobility in a Minneapolis Sample'. Social Forces, vol. 27, pp. 413-417.
- CLARK, W.A.V. (1970) 'Measurement and Explanation in Intra-urban Residential Mobility'. Tijdschrift Voor Econ. En. Soc. Geog., vol. lxi, no. 1, pp. 49-57.
- CLARK, W.A.V. (1971) 'A Test of Directional Bias in Residential Mobility'. In Perspectives in Geography, I - Models of Spatial Variation. Edited by Harold McConnell and David Yaseen, Northern Illinois University Press, Illinois, pp. 2-27.
- DONALDSON, B. and JOHNSTON, R.J. (1973) 'Intra-urban Sectoral Mental Maps: Further Evidence from an Extended Methodology'. Geographical Analysis, vol. 5, no. 1, pp. 45-54.
- GREER-WOOTTEN, B. and GILMOUR, G.M. (1972) 'Distance and Directional Bias in Migration Patterns in Depreciating Metropolitan Areas'. Geographical Analysis, vol. 4, pp. 92-97.

- HARRIS, C.D. and ULLMAN, E.L. (1945) 'The Nature of Cities' Reprinted in Readings in Urban Geography, Edited by H.M. Mayer and C.F. Kohn, University of Chicago, 1959, pp. 277-286.
- HAYNES, K.E. and RUBE, M.I. (1973) 'Directional Bias in Urban Population Density'. Annals, Association of American Geographers, vol. 63, no. 1, pp. 40-47.
- HORTON, F.E. and REYNOLDS, D.R. (1971b) 'Action Space Differentials in Cities'. In Perspectives in Spatial Geography, I. Models of Spatial Variation. Edited by Harold McConnell and David A Yaseen, Northern Illinois University Press, Illinois, pp. 83-104.
- HUMPHREYS, J.S. (1973) 'Intra-urban Migration and Residential Structure'. No. 6, Monash Publications in Geography, Dept. of Geography, Monash University, Melbourne.
- JOHNSTON, R.J. (1969b) 'Population Movements and Metropolitan Expansion: London 1960-61'. Transactions of the Institute of British Geographers, No. 46, pp. 69-91.
- JOHNSTON, R.J. (1971a) 'Some Limitations of Factorial Ecologies and Social Area Analysis'. Economic Geography, vol. 47, no. 2, (Supplement), pp. 314-323.
- JOHNSTON, R.J. (1971b) Urban Residential Patterns. An Introductory Review. G. Bell and Sons, London.
- JONES, T.A. (1968) 'Statistical Analysis of Orientation Data' Journal of Sedimentary Petrology, vol. 38, no. 1, pp. 61-67.
- KRUMBEIN, W.C. (1939) 'Preferred Orientation of Pebbles in Sedimentary Deposits'. Journal of Geology, vol. 47, pp. 673-706.
- MISES, R.V. (1918) 'Über die Ganzzähligkeit der Atomgewichte und verwandte Fragen'. Physikalische Zeitsch, vol. 19, pp. 490-500.
- MOORE, E.G. (1966b) 'Residential Mobility in an Urban Context: A Systems Approach'. Unpublished Ph.D. thesis, University of Queensland.
- MOORE, E.G. (1969b) 'The Nature of Intra-urban Migration and Some Relevant Research Strategies'. Proceedings of the Association of American Geographers, pp. 113-116.

- MOORE, E.G. (1971) 'Comments on the Use of Ecological Methods in the Study of Residential Mobility in the City'. Economic Geography, vol. 47, no. 1, pp. 73-85.
- MORRILL, R.L. (1965a) 'Migration and the Spread and Growth of Urban Settlement'. Lund Studies in Geography, Series B. No. 26.
- MORRILL, R.L. and PITTS, F.R. (1967) 'Marriage, Migration and the Mean Information Field: A Study in Uniqueness and Generality'. Annals, Association of American Geographers, vol. 57, pp. 401-422.
- OLSSON, G. (1965a) 'Distance and Human Interaction A Migration Study'. Geografiska Annaler (Series B). vol. 47 B, pp. 3-43.
- OLSSON, G. (1965b) Distance and Human Interaction. A Review and Bibliography. Bibliography Series no. 2. Regional Science Research Institute.
- RAVENSTEIN, E.G. (1885) 'The Laws of Migration'. Journal of the Royal Statistical Society, vol. 48, pp. 167-235.
- ROSS, H.L. (1962) 'Reasons for Moves to and from a Central City Area'. Social Forces, vol. 40, pp. 261-263.
- ROSSI, P.H. (1955b) Why Families Move: A Study in the Social Psychology of Urban Residential Mobility. The Free Press, New York.
- SIMMONS, J.W. (1968) 'Changing Residence in the City - A Review of Intra-urban Mobility'. Geographical Review, vol. 58, no. 4, pp. 622-651.
- STOUFFER, S.A. (1940) 'Intervening Opportunities: A Theory Relating Mobility and Distance'. American Sociological Review, vol. 5, pp. 845-867.
- TRYON, R.C. (1967) 'Predicting Group Differences in Cluster Analysis: the Social Area Problem'. Multivariate Behavioural Research, vol. 2, pp. 453-475.
- WATERMAN, T.H. (1963) 'The Analysis of Spatial Orientation'. Ergebnisse Der Biologie, vol. 26, pp. 98-117.
- WHITELAW, J.S. and GREGSON, J.S. (1972) 'Search Procedures in the Intra-urban Migration Process'. Monash Publications in Geography, No. 2.

- WHITELAW, J.S. and ROBINSON, S. (1972) 'A Test for Directional Bias in Intra-urban Migration'. New Zealand Geographer, vol. 28, no. 2, pp. 181-193.
- WOLPERT, J. (1967) 'Distance and Directional Bias in Inter-urban Migratory Streams'. Annals, Association of American Geographers, vol. 57, pp. 605-616.

CHAPTER 8

COMPARISON OF SELECTED POPULATION CHARACTERISTICS AND MOVEMENTPARAMETERS

Three major clusters of social variables should be examined for their contributions to mobility: urbanization, . . . , economic status, . . . ; and segregation, . . .

SIMMONS (1968, p.629)

OUTLINE

This chapter explores the relationships between each of the two indices of population movement (dependent variables) and a selection of twenty-six population and housing variables (independent variables) chosen to enable, amongst other things, comparison with the findings of two other Australian studies. Several techniques are evaluated and utilized in this chapter by application to a matrix of Pearson Correlation Coefficients. Simple linkage analysis of the variables reveals several distinct clusters, each with its own set of closely related variables. The central core of variables comprises essentially age-related components.

Comparison of pairs of variables, while controlling for all others, by Partial Correlation, alters the emphasis, and the factors of owner-occupancy and mean age of adults emerge related to population turnover, and the child-woman ratio to net migration. Objective identification of the most 'important' variables is achieved by

application to the correlation matrix of 'multiple regression'. It reveals that population turnover rates are best 'explained' by the proportion of occupied private houses, and net migration rates by the mean age of the adult population.

Finally, it is argued that the study as a whole shows the need for further research to discover the underlying reasons for the particular spatial distributions of aggregated movement patterns and associated factors here described. Amongst others, there is a need for work concentrating on individual behaviour of residents to relate their perceived and observed motivations for residential movement to the aggregated movement patterns. Linkage with this present study can be achieved by utilizing the same areas and population parameters so that change through time can be assessed.

CHAPTER 8 COMPARISON OF SELECTED POPULATION CHARACTERISTICS AND
MOVEMENT PARAMETERS

CONTENTS

	Page
8.1 INTRODUCTION	252
8.1.1 Background	252
8.1.2 Aim of this Chapter	253
8.2 SEARCH FOR AN ANALYTICAL PROCEDURE (Using Correlation Coefficients)	255
8.2.1 Social Area Analysis or Factorial Ecology	255
8.2.2 Selection of Variables	261
8.2.3 Definition of Selected Variables	264
8.3 LINKAGE ANALYSIS	268
8.3.1 Steps in Derivation of First Generation Linkages	269
8.3.2 Steps in Derivation of Second Generation Linkages	269
8.4 COMPARISON OF THREE AUSTRALIAN CORRELATION STUDIES OF POPULATION TURNOVER	272
8.4.1 Population Turnover	274
8.4.2 Other Variables	276
8.4.3 Summary	280
8.5 PARTIAL CORRELATION ANALYSIS	280
8.5.1 Shortcomings of Simple Correlation Analysis	280

	249.
	Page
8.5.2 Application of Partial Correlation	283
8.5.3 Population Turnover	283
8.5.4 Net Migration	285
8.6 MULTIPLE REGRESSION	287
8.6.1 Population Turnover	288
8.6.2 Net Migration	289
8.7 CHAPTER EIGHT SUMMARY AND CONCLUSIONS	291
8.8 THESIS SUMMARY AND CONCLUSIONS	293
8.8.1 Major Intent and Findings	294
8.8.2 Implications for Further Research	297
8.8.3 Summary Evaluation	301
REFERENCES	303

CHAPTER 8 COMPARISON OF SELECTED POPULATION CHARACTERISTICS AND
MOVEMENT PARAMETERS

LIST OF FIGURES

Figure		Page
8.1	Linkage groups based upon the matrix of simple correlations between selected variables, Adelaide Statistical Division	facing p. 270

CHAPTER 8 COMPARISON OF SELECTED POPULATION CHARACTERISTICS AND
MOVEMENT PARAMETERS

LIST OF TABLES

Table	Page
8.1 Summary of Stimson's factor analysis of Metropolitan Adelaide 1966, based upon data drawn from the census 1966 (Australian Bureau of Statistics)	258
8.2 Definition of variables and derivation of components used in their calculation for statistical analysis	pp. 265, 266,267
8.3 Matrix of Pearson Correlation Coefficients between all selected variables	facing p.268
8.4 Comparison of ecological correlations between variables in three Australian cities, Brisbane (B), Sydney (S) and Adelaide (A)	facing p.274
8.5 Partial correlation coefficients between (a) annual index of population turnover and various independent variables and (b) annual index of net migration and the same independent variables, based on electoral subdivisions in the Adelaide Statistical Division	facing p.283
8.6 Multiple correlation between population turnover and seven independent variables	facing p.288
8.7 Multiple correlation between net migration and eight independent variables	facing p.289

CHAPTER 8. COMPARISON OF SELECTED POPULATION CHARACTERISTICS AND
MOVEMENT PARAMETERS

8.1 INTRODUCTION

8.1.1 Background

The main emphasis of chapters five, six and seven of this thesis has been upon describing geometric characteristics of aggregated migratory movements of electors between the fifty electoral subdivisions of the Adelaide Statistical Division. At several stages of the argument, brief references have been made to associated population characteristics. For example, in chapter three, while discussing the extent and distribution of adults not included in electoral rolls, reference was made to the proportion of adult aliens within local government areas. In attempts to test the reliability of electoral data, statistics were presented for two age categories of British Nationals, numbers of deaths and rates of natural increase. However, the table summarizing movement characteristics for three concentric zones of Adelaide (Table 7.5) made no use of any other population characteristics. It has been shown that both, movement rates and the geometric characteristics of residential movements, exhibit considerable and systematic spatial variation throughout the study area.

It has not been possible to attribute geometric variations in residential movement to particular population subgroups because of an absence of suitable data on population characteristics - a lack which arose from difficulties in collection of the original data from electoral rolls which made it impossible to extract even

the three recorded personal characteristics of birth-date, sex, and occupation. In the present context of analysis of intra-urban movement there are two major groupings of the total population whose characteristics are of obvious interest for comparison, namely, movers and stayers. Demographic information is not separately available at present for these two groups but provision of it would enable assessment of change, both in the kind and extent of the aggregate population characteristics of both origin and destination areas under the recorded flow of transfers during the study period. It must be observed that by following a pattern similar to that set in this thesis, study to discover such facts for the Adelaide area is not only practicable but certain to reveal some important implications for urban planners of every kind.

Work already carried out in South Australia (Hugo 1971, chapters 5 and 6) shows that between 1961 and 1966 streams of migrating electors from both urban and rural areas rarely constituted a representative cross-section of the resident population either in their districts of origin or destination (Hugo, 1974, p.88). For example, it was found by analyzing migration streams by age, sex and occupation that "the net migration losses experienced by rural communities are highly selective of females and of the school-leaving age groups" (Hugo, 1974, p.91).

8.1.2 Aim of this chapter

Although findings of the kind cited above are rendered unattainable in the present case by the limitations imposed by the data source, there remain, nevertheless, avenues open for useful

exploration. The primary purpose of this chapter is to extend, into related population characteristics, discussion of rates of residential change measured by indices of annual population turnover and net migration, matters already discussed in some length in chapter four. The intention is to discover the extent to which behavioural differences, as expressed in movement rates, are associated with systematic differences in objectively-measured population characteristics. As already pointed out, this cannot be done here separately for either the mover or the stayer part of the population. The only possibility remaining, therefore, is that specific areas be compared both for indices of movement and population characteristics. The same sets of areal units, namely the fifty electoral subdivisions, which have served already in this analysis as both origin and destination areas, are appropriate for this purpose.

Demographic information about residents of the fifty electoral subdivisions, (although not normally available for these specific areal units) is readily aggregated from data collected at the 1971 census because, at an earlier stage in this study, census collector's districts were systematically amalgamated to match exactly the territories of the electoral subdivisions (see sections 3.5 and 4.6). The data on population and movement are not only coincident for space but almost so for time because the census was conducted on 30th June 1971 and the residential movements cover the period 14th March 1970 to 11th June 1971. It is clear then that the whole range of census derived population parameters is available for comparison with rates of movement. The critical decision is the choice of the most appropriate measures and their use in a variety of indices. This is

a matter for which there are some existing works to serve as guides.

8.2 SEARCH FOR AN ANALYTICAL PROCEDURE (Using correlation coefficients)

8.2.1 Social Area Analysis or Factorial Ecology

Since the work of Park and Burgess and other sociologists of the 'Chicago School' in the 1920's (Park, Burgess and McKenzie, 1925) there has been a growing interest in the identification and quantification of measures of urbanization, and particularly in attempts to express this in terms of the attributes and behaviour of the human population (Johnston, 1971a, pp 314-316; Johnston, 1971b, pp 64-69). In this tradition, great impetus was given to the wide acceptance of what has come to be known as 'social area analysis' by the work in California of Shevky and Bell (1955). In applying social area analysis they used a battery of statistically generalizing procedures upon a wide selection of population parameters from the census tracts of Los Angeles and San Francisco. They identified three general social factors or constructs, which may be termed respectively, economic or social status, urbanization or family status, and ethnicity. Underlying the large amount of work in this tradition, now more commonly called 'factorial ecology', has been the aim of obtaining from a broad array of population data (the universe) a small number of basic factors (discrete sets) which are a reliable expression of the total distribution of an urban population. Some Australian examples of work in this style are Jones (1969), Parkes (1972) and Stimson (1971).

Factorial ecology must be evaluated in the present context, therefore, as a possible means of achieving the stated aims of this chapter. Nevertheless, because the analyses of this chapter constitute only a relatively small part of the total study, it is inappropriate here to embark upon an extensive review of either the historical development or the theoretical underpinnings of factorial ecology. These aspects are dealt with comprehensively by Rees (1970), Berry (1971), Rees (1971) and other authors in the same volume as Berry (1971) while a useful overview is provided by Abler, Adams and Gould (1971, pp. 149-189). Just as inappropriate here would be a survey of the considerable number of recent studies which have utilized this approach. A comprehensive list and outline appear in Rees (1971, pp. 222-232). There is, however, merit, if not necessity, in making clear what is meant by 'factorial ecology' and the precedents or intellectual antecedents which led to the consideration of this method in the present context. Furthermore, self-imposed limitations to its implementation must be assessed.

"Factorial analysis is a family of techniques ... that seeks ... redundancy in sets of variables. The techniques mostly work on matrices of correlation coefficients ... and reduce these to sets of hybrid variables which represent combinations of the initial set. In this way, the number of variables is reduced, hopefully to a more manageable ... set of descriptions."
Johnston, 1973a, p.129

According to Berry (1971, p. 209, citing Rees, 1971) the term factorial ecology has been applied only to studies using the city as study area, census tracts as units of description, and census variables as manifest input. Rees prefers to extend the use of the term to social science studies in which 'ecological' simply refers

to use of areal units as observations. There is broad agreement that the three social constructs identified by Shevky and Bell are widely observable, if not universal, and are usually called socio-economic status, familism (or urbanization) and ethnic status (or segregation). Nevertheless, there has been continuing debate (Johnston, 1971a, pp. 314-319) about the validity of the basic assumptions and the efficacy of some of the procedures. Although it is a basic procedural feature of factorial ecology to ensure that the summarizing factors which emerge are statistically uncorrelated this does not guarantee that they are in fact independent (Johnston, 1971a, p. 318). It is not surprising therefore, that questions arise about the meaning of the generalized groupings of statistically independent factors, especially as the relative dominance or mix, and therefore levels of 'explanation', vary from one city to another. Rees (1971, p. 222) has pointed out that factor analysis is not a hypothesis-testing procedure but is able to predict "descriptive dimensions rather than causal influences of a phenomenon under study."

Although the usually, but not necessarily, three-fold classification represents a useful and objectively derived descriptive summary of a wide range of variables it is not wise to assume in the absence of suitable research in a specific city that the same combination applies universally. Nevertheless, the technique has been shown to yield useful results in several separate Australian cities, for example, Brisbane (Timms, 1971), Melbourne (Jones, 1969), Newcastle (Parkes, 1971 and 1973) and Adelaide (Stimson, 1971; Stimson and Cleland, 1975). Through his application of factorial analysis to residential metropolitan Adelaide, an area similar to

that of this present study, Stimson has already amply demonstrated the explanatory power of a small number of generalized social factors in substantially the same population and at much the same time as the present movement study. The accompanying table (Table 8.1) is drawn from the earlier study by Stimson (1971, p.3) in which he made use of a wide selection of variables based on population and dwelling characteristics derived from the 1966 census. It was applied to 139 areas of amalgamated collectors districts and confirmed in the Adelaide situation the existence of social area dimensions of the Shevky-Bell type (Stimson, 1971, p.15).

TABLE 8.1

Summary of Stimson's factor analysis of Metropolitan Adelaide 1966, based upon data drawn from the census of 1966 (Australian Bureau of Statistics)

	Factors	Eigen value	% total variance explained	Cumulative % total variance explained
I	Socio-economic status	26.86	24.20	24.20
II	Household composition, low familism	21.03	18.95	43.15
III	Recent U.K. migrants	9.64	8.69	51.85
IV	High ethnicity	6.84	6.96	58.02
V	Aged, low familism	4.37	3.94	61.96
VI	High N.W. & E European ethnicity	3.48	3.13	65.10

Source: Stimson (1971, p.3)

Interestingly, it was observed that there was a not inconsiderable amount of "interdependence among the three constructs of socio-economic status, familism and ethnicity which were hypothesised as separate dimensions within the social area schema" (Stimson, 1971, p.16). Later work in Adelaide, by the same author operating on similar lines with data from the 1971 census, has yielded similar general findings (Stimson and Cleland, 1975). In the light of the above it is intended to accept the threefold classification as an eminently reasonable framework for further discussion in the Adelaide case. These constructs correspond to the "three major clusters of social variables" listed in the thematic quote with which this chapter opened (Simmons, 1968, p.629). Nevertheless, the constructs themselves are so broad and comprised of so many component variables that it seems preferable, in a comparative study of migratory movement rates, to have recourse to the relevant population variables themselves, rather than generalized groups of variables alone. Although the factors isolated in factor analysis are uncorrelated, it has been pointed out that they are not necessarily independent (Stimson and Cleland, 1975, p.10; Meyer, 1971; Johnston, 1971a) and that "crucial variables in the factors exhibit a relationship which is not apparent when only the factor results are examined" (Meyer, 1971, p.342). Therefore, since the present purpose involves looking for variables having specific relationships with residential mobility rates, it is appropriate to use correlation methods (Meyer, 1971, p.343) which enable, not only the identification of the level of probability of a relationship, but also the quantitative description of the strength and direction of that relationship.

Factorial ecology is rejected as a method of analysis for the present study because:

- (a) The task is to compare two different populations on different measures. The one, electors, is a large subset of the other, the total population, and, as shown elsewhere (sections 3.6 and 3.9) its proportionate share varies between S.D.s. A complex weighting procedure would be necessary to compensate for this variation. Furthermore, Sanders (1975, p. 347) warns of the 'ecological fallacy' of assuming that correlations taken on populations are equal to those taken on persons.
- (b) The particular spatial units (electoral subdivisions) unavoidably adopted for this study (section 3.7) display such great size differences between them as to negate assumptions made in factorial ecology about the internal homogeneity of spatial units (Stimson and Cleland, 1975, p. 27).
- (c) It seems an over-sophisticated and elaborate procedure in view of the basically simple aim of this present section. There is a danger of using what Moore (1969b, p.115) in discussing sampling procedures, called "unnecessarily complex analytical sledgehammers ... to yield their hidden generalizations".

However, when the aim is to make statements about relationships between specific variables of theoretical interest then of the two methodologies, factor analysis and correlation, "correlation methods would appear to be more appropriate" (Meyer, 1971, p. 343).

Comparison of selected population characteristics and annual rates of movement will be undertaken in this chapter by development of a correlation matrix for the study area as a whole, setting out the calculated levels of association using the Pearson Product-moment Coefficient of Correlation. This was judged to be the most appropriate technique after consideration not only of other studies but also of the available data and resources. From the matrix, and further analyses based upon it, it should become apparent that certain broad categories of rates of population turnover and/or net migration may be associated with identifiable levels of certain population characteristics. However, even where systematic differences or similarities are identified and described by correlation coefficient, it does not prove the existence of causal relationships (Blalock, 1972, p.443; Moore, 1969a, pp.18-19). Nevertheless, the greater understanding achieved by the careful description of complex inter-relationships enables both the identification of possible causal relationships, which subsequently may be investigated further, and the predicting with greater confidence of likely developments in spatial patterns.

8.2.2 Selection of Variables

As already indicated in part, the method of analysis selected involves the statistical comparison of the movement indices (dependent variables) and various population parameters (independent variables) by means of a correlation matrix based upon the Pearson Product-moment Coefficient. Having chosen to utilize the threefold classification of variables from factorial ecology, the following two problems

require solution in the practical application: firstly, which specific population parameters are the most suitable ones to use in estimating status on the generalized factors, and secondly, which of the selected population parameters best match the movement indices. Guidance in solving the first problem may be taken from previous studies, and the second, hopefully, will be answered by analysis of the correlation matrix set up as a result of choices made in answer to the first.

The most immediate need is the selection of 'appropriate' or 'relevant' variables. Two studies with similar needs provide some useful guidance. Firstly, for example, residential mobility rates for Brisbane between 1954 and 1961 were studied by Moore (1969a, 1970, 1971 and 1972). With support drawn from pioneer studies (principally Rossi, 1955) and local experience, he selected from the tabulations of the 1961 census C.D.s a range of 'relevant variables' relating to socio-economic and demographic characteristics. Along with rates of population turnover these were presented in a matrix showing ecological correlations between all variables used. Relationships were explored and possible explanations developed, special note being taken where relationships were not of expected intensity or direction. Secondly, Sinclair (1975) has used a similar selection of variables in his study of turnover rates in the inner Sydney Metropolitan Area for the intercensal period 1966 to 1971. With two similar case studies available for comparison from Australian state capital cities, it would be wasteful not to ensure that this present work on yet another Australian capital city is able to be compared by utilizing the same variables (section 8.4). Nevertheless, the following are good reasons

for adding extra variables to the list: firstly, an alternative measure may prove to be a better indicator than one selected in another city, and secondly, some additional relationships may be worth exploring for their own sakes.

Another study of interest is that of population age structure and associated population characteristics in Kansas City, Missouri (Coulson, 1968). Coulson devised a single quantitative measure or index for the generalized expression of the age distribution of an aggregated population. He then established a wide array of population variables and tested the strength of their relationships with the new age index. Use will be made here of both the age index itself and selections from Coulson's array of independent variables.

The selection of independent variables for the present study was based, therefore, upon the following three points: firstly, an examination of previous studies with which useful comparisons could be made if care were taken to ensure comparability of data (for example Moore, 1969a; Sinclair, 1975; Coulson, 1968; Stimson, 1971); secondly, the need to explore more widely for any measures of particular local importance or aptness; and thirdly, consideration of the range of information available from the 1971 census conducted by the Australian Bureau of Statistics. It is, of course, essential for the operation of this exercise that the selected independent variables be numerically quantifiable.

8.2.3 Definition of selected variables

The operational terms in which the selected variables are individually expressed were dictated in part by the nature of the available data. As pointed out by Coulson (1968, p.165) the validity of analyses based upon such parameters depends upon the ability of the measures selected to reflect the characteristics intended by the researcher. The operational definitions set up for this present exercise are listed in the accompanying Table 8.2 which shows the components and formulae used in their calculation.

The data were extracted in the Computing Centre, University of Adelaide* from the tape[#] supplied by the Australian Bureau of Statistics. Details of the contents and arrangements are provided in the handbook 'Magnetic Tape Summaries of Collector's District Data' (C.B.C.S., 1972). The amalgamating of census collector's districts (C.D.s) to achieve areas exactly equivalent to electoral subdivisions (S.D.s) was discussed in sections 3.4 and 3.5.

* Special computer programmes had to be written both to extract the data required from the A.B.S. tape and to re-record it in a data-file suitable for further use in conjunction with the "Statistical Package for the Social Sciences" (see Nie, et al, 1970, pp.15-21). This writer acknowledges with gratitude the valuable assistance given by Mrs. C. Klingner and Miss R. Lewis of the Computing Centre, University of Adelaide.

The present writer was instrumental in obtaining for the University of Adelaide a copy of the magnetic tape 'Summaries of Collector's District Data' from the census of 1971 and requested development of the special programmes to utilize it on the C.D.C. 6400 machine.

TABLE 8.2

Definition of variables and derivation of components used in their calculation for statistical analysis^(a)

Symbol	Variable name	Components and calculation
X ₁	Index of age differential	$\frac{(\text{population } 0 \text{ to } 14 \text{ yr}) - (\text{population } \geq 65\text{yr})}{\text{total population}}$
X ₂	Mean age of total population	15, five-year age cohorts, middle year multiplied by number of persons in the group. Product (person-years) for all age groups, summed and divided by the total population. Result is 'mean age'
X ₃	Mean age of adult population	calculated as in X ₂ , but only for persons 20 years and over.
X ₄	Child-woman ratio	$\frac{\text{children } 0 \text{ to } 4\text{yr}}{\text{no. females } 15 \text{ to } 44\text{yr}} \times \frac{1000}{1}$
X ₅	% population 0 to 15 yr (dependent chn.)	$\frac{\text{children } 0 \text{ to } 15 \text{ yr}}{\text{total population}} \times \frac{100}{1} \%$
X ₆	Age structure index (Regression coefficient, after Coulson, 1968)	15, five-year age cohorts as in X ₂ . The regression coefficient 'b' is the slope of the best fit line of the age distribution pyramid
X ₇	% Australian born in the total population	$\frac{\text{number born in Australia}}{\text{total population}} \times \frac{100}{1} \%$
X ₈	Population density (persons per square km)	$\frac{\text{total population}}{\text{area of S.D. (S.km)}}$
X ₉	% non-movers	$\frac{\text{no. of persons in same dwelling } 1971 \text{ as in } 1966}{\text{total persons}} \times \frac{100}{1} \%$
X ₁₀	% adult population with tertiary qualifications	$\frac{\text{no. persons with tertiary qualifications}}{\text{no. } 18 \text{ yr and over}} \times \frac{100}{1} \%$
X ₁₁	% single females	$\frac{\text{females over } 15 \text{ yr never married}}{\text{total females}} \times \frac{100}{1} \%$
X ₁₂	% single males	$\frac{\text{males over } 15 \text{ yr never married}}{\text{total males}} \times \frac{100}{1} \%$

TABLE 8.2 (Cont)

Symbol	Variable name	Components and calculation
X ₁₃	% males employers or self-employed	$\frac{\text{no. male employers} + \text{no. males self-employed}}{\text{total males}} \times \frac{100}{1} \%$
X ₁₄	% labour force employers/self-employed	$\frac{\text{no. in labour force employers} + \text{self-employed}}{\text{total in labour force}} \times \frac{100}{1} \%$
X ₁₅	% male labour force employers/self-employed	$\frac{\text{no. of male employers} + \text{self employed}}{\text{total male labour force}} \times \frac{100}{1} \%$
X ₁₆	% employed in professional and administrative occupations	$\frac{\text{no. persons in professional and administrative occupations}}{\text{total persons employed}} \times \frac{100}{1} \%$
X ₁₇	private home index	$\frac{\text{total occupied private 'houses' (b)}}{\text{total dwellings (c)}} \times \frac{100}{1} \%$
X ₁₈	separate private house index	$\frac{\text{separate houses}}{\text{total dwellings}} \times \frac{100}{1} \%$
X ₁₉	% dwellings owner occupied	$\frac{\text{private dwellings owner occupied}}{\text{total dwellings}} \times \frac{100}{1} \%$
X ₂₀	% dwellings occupied by tenants of state housing authority	$\frac{\text{no. dwellings tenanted from state}}{\text{total dwellings}} \times \frac{100}{1} \%$
X ₂₁	% dwellings unoccupied	$\frac{\text{no. unoccupied dwellings}}{\text{total dwellings}} \times \frac{100}{1} \%$
X ₂₂	distance from C.B.D. (km)	distance between S.D. centroids and C.B.D. calculated in centroids determination programme (section 4.6.2)
X ₂₃	distance from P.C.G. (km)	distance between S.D. centroids and calculated population centre of gravity derived from application of centroids determination programme (section 4.6.2)
X ₂₄	area of sub-division (sq km)	measured by planimeter from maps and check calculated by computer from coordinate references

Symbol	Variable name	Components and calculation
Pt	population turn-over	calculated as explained in section 4.3, using electoral roll data
Nm	net migration	calculated as explained in section 4.3, using electoral roll data
Er	total on electoral roll	number of electors on subdivisional roll at 11/6/71
Bn	British nationals 21 yr and over	special tabulation carried out by Australian Bureau of Statistics (1971 census)

(a) Sources

Components, except Pt, Nm, and Er, have been derived from the Census, June 30, 1971, Australian Bureau of Statistics. The indices Pt, Nm and Er were applied to data supplied by the State Electoral Department, Adelaide.

The following publications have been consulted in defining terms:

'Magnetic tape summaries of collector's district data, census 71 technical specifications' Bureau of Census and Statistics, Australia (1972).

Australian Bureau of Statistics (1973) 'Characteristics of the population and dwellings Local Government Areas'. Bulletin 7, Part 4, South Australia, pp. i to xx.

- (b) The A.B.S. 1971 census definition of 'house' includes separate house, semi-detached house, attached house, terrace or row house, villa unit or town house but excludes self-contained flat or home unit, non-self-contained flat, improvised home, caravan, houseboat and other.
- (c) 'Dwellings' comprise those premises which on census night were (1) occupied by a household (persons or group of persons living and eating together) and (2) unoccupied habitable premises built specifically for private living purposes. Dwellings are described as 'non private' if they provide group accommodation and have been excluded from all lines of the accompanying indices and tables.

TABLE 8.3

Matrix of Pearson Correlation Coefficients between all selected variables

(Names, definitions and derivations shown in Table 8.2)

	VARIABLES (X)																								PT	NM	ER	BN
	1	2	3	4	5	6	7	8	9	10	11	12	13	14	15	16	17	18	19	20	21	22	23	24				
X1		-98	-89	85	97	-98	-51	-60	-24	-30	-88	-82	06	11	07	38	68	53	30	36	-09	49	42	34	-67	64	01	-01
X2	-98		96	-88	-95	100	54	60	39	27	86	82	04	09	-05	34	-60	-52	-30	-30	06	-47	-41	-32	61	-72	04	04
X3	-89	96		-86	-82	96	54	55	55	24	77	76	00	-04	00	27	-42	-45	-28	-19	05	-36	-33	-24	48	-78	10	10
X4	85	-88	-86		84	-88	-42	-63	-49	-17	-86	-83	19	23	20	-27	56	64	46	04	09	52	49	35	-54	76	-14	-15
X5	97	-95	-82	84		-95	-52	-60	-23	-24	-87	-84	09	15	11	-33	73	55	32	36	09	54	46	38	-67	62	05	03
X6	-98	100	96	-88	-95		54	60	39	27	86	82	-04	-09	-05	34	-60	-52	-30	-30	06	-47	-41	-32	61	-72	04	04
X7	-51	54	54	-42	-52	54		18	39	46	33	31	16	09	15	45	-19	00	14	-28	17	-17	-08	-11	09	-32	-11	-12
X8	-60	60	55	-63	-60	60	18		42	-07	51	51	-40	-42	-40	-03	-50	-50	-37	00	-38	-71	-70	-58	42	-54	27	27
X9	-24	39	55	-49	-23	39	39	42		-22	17	33	03	03	03	-27	17	-12	-20	28	-31	-21	-27	-13	-14	-68	26	21
X10	-30	27	24	-17	-24	27	46	-07	-22		27	01	18	14	20	97	22	13	41	-49	08	-21	-09	-09	18	01	-09	-08
X11	-88	86	77	-86	-87	86	33	51	17	27		93	-08	-12	-08	39	-71	-68	-51	-17	03	-53	-49	-29	67	-68	05	08
X12	-82	82	76	-83	-84	82	31	51	33	01	93		-05	-07	-06	10	61	-69	64	-04	06	-46	-44	-22	61	-75	01	04
X13	06	-04	00	19	09	-04	16	-40	03	18	-08	-05		99	100	08	12	38	32	-39	47	42	45	49	-18	15	-44	-44
X14	11	-09	-04	23	15	-09	09	-42	03	14	-12	-07	99		99	03	16	38	31	-34	43	45	47	49	-22	15	-41	-41
X15	07	-05	00	20	11	-05	15	-40	03	20	-08	-06	100	99		09	13	38	33	-38	45	42	45	48	-19	14	-42	-42
X16	38	34	27	-27	-33	34	45	-03	-27	97	39	10	08	03	09		-34	01	33	-49	06	-27	-16	-17	27	-03	-03	-01
X17	68	-60	-42	56	73	-60	-19	-50	17	22	-71	61	12	16	13	-34		64	39	39	-03	53	46	40	-78	41	09	05
X18	53	-52	-45	64	55	-52	00	-50	-12	13	-68	-69	38	38	38	01	64		89	-36	17	45	46	34	-51	55	-01	-03
X19	30	-30	-28	46	32	-30	14	-37	-20	41	-51	64	32	31	33	33	39	89		-60	13	26	32	11	-37	51	-01	-03
X20	36	-30	-19	04	36	-30	-28	00	28	-49	-17	-04	-39	-34	-38	-49	39	-36	-60		-31	12	01	07	-35	-06	19	18
X21	-09	06	05	09	09	06	17	-38	-31	08	03	06	47	43	45	06	-03	17	13	-31		49	57	61	13	25	-41	-39
X22	49	-47	-36	52	54	-47	-17	-71	-21	-21	-53	-46	42	45	42	-27	53	45	26	12	49		98	65	-38	47	-19	-20
X23	42	-41	-33	49	46	-41	-08	-70	-27	-09	-49	-44	45	47	45	-16	46	46	32	01	57	98		65	-29	48	-23	-23
X24	34	-32	-24	35	38	-32	-11	-58	-13	-09	-29	-22	49	49	48	-17	40	34	11	07	61	65	65		-24	26	-09	-09
PT	-67	61	48	-54	-67	61	09	42	-14	18	67	61	-18	-22	-19	27	-78	-51	-37	-35	13	-38	-29	-24		-49	03	05
NM	64	-72	-78	76	62	-72	-32	-54	-68	01	-68	-75	15	15	14	-03	41	55	51	-06	25	47	48	26	-49		-29	-28
ER	01	04	10	-14	05	04	-11	27	26	-09	05	01	-44	-41	-42	-03	09	-01	-01	19	-41	-19	-23	-09	03	-29		100
BN	-01	04	10	-15	03	04	-12	27	21	-08	08	04	-44	-41	-42	-01	05	-03	-03	18	-39	-20	-23	-09	05	-28		100

NOTE: Decimal point has been omitted to conserve space

8.3 LINKAGE ANALYSIS

Following the selection and definition of the twenty-eight variables as described in the previous section of this chapter, their values were calculated from data gathered at the census of June 30, 1971 and stored on computer tape which was manipulated on the University of Adelaide's C.D.C. 6400 computer. Because of their bulk neither the raw data nor their indices are listed in this thesis. However, the geographic distribution of values amongst the fifty electoral subdivisions is shown on a separate map for each variable arranged in quintiles (Appendix A1 to A34). The next step was to calculate the Pearson Product-moment Coefficient of Correlation between all variables by utilizing computer programmes available in the 'Statistical Package for the Social Sciences' (S.P.S.S., Nie, et al, 1970, pp.143-156). The results of this application are set out in the accompanying matrix (Table 8.3).

A method of elementary linkage analysis developed by McQuitty (1957) makes it possible to explore inter-relationships within a set of variables by objective classification into 'mutually exclusive groups on the basis of coefficients of correlation' (Coulson, 1968, p.166). It is observed by Yeates (1974, p.96) that the technique determines 'typal' structures in which every member of a type is more like some other member of that type than it is to any other type. The following modified outline of elementary linkage analysis is based upon both the study by Coulson (1968, pp. 166-169) and an explanation by Yeates (1974, p.96). It was the means by which the technique was applied in the present study to the master matrix of correlation coefficients (Table 8.3).

8.3.1 Steps in derivation of first generation linkages

- (1) Underline the highest correlation coefficient in each column of the correlation coefficient matrix.
- (2) Select the highest entry in the matrix. (A coefficient of 1.00 was recorded between X6 Age Structure Index and X2 Mean Age of the total population.) These variables constitute the first two members of the first type.
- (3) By reading across the rows of the highest entries from (2) above select the variable (underlined) highest correlated with them. These can be called 'first relations'.
- (4) For all first relations select 'second relations' if they exist, in a manner similar to that described in (3) above.
- (5) In analogous fashion, third and fourth order relations can be determined.
- (6) Select a second reciprocal relation excluding all those variables classified in the first type and repeat above steps until all the variables are grouped into typical relation sets.

This application resulted in eight groups of variables as shown in the accompanying diagram (Fig. 8.1). These groups are discussed below after the explanation of the steps in derivation of the second generation of linkages.

8.3.2 Steps in derivation of second generation linkages

This stage was undertaken to discover the way in which the groups resulting from stage one are themselves linked by correlations which are necessarily of a lower order.

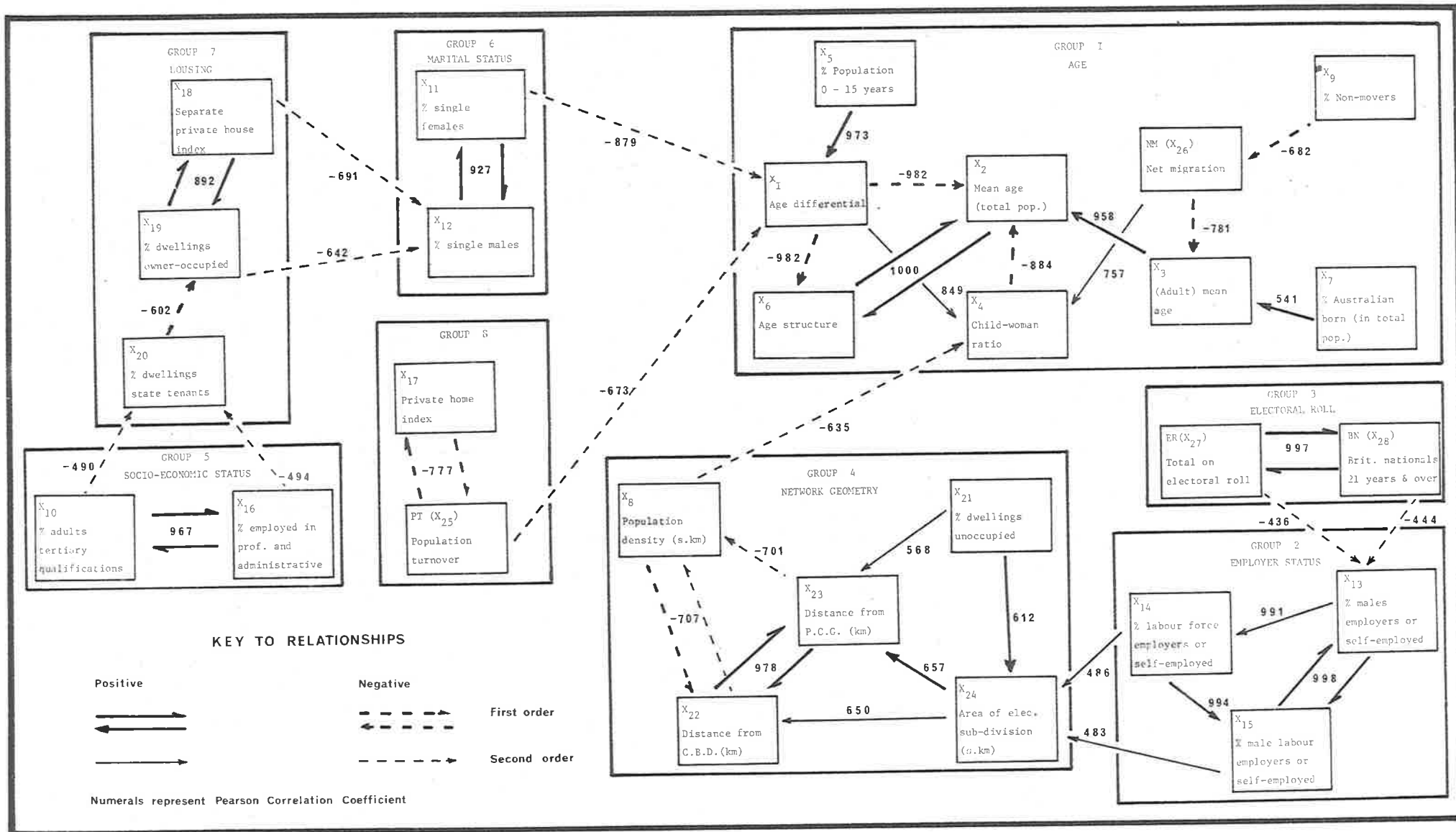

FIG. 8.1: Linkage groups based upon the matrix of simple correlations between selected variables, Adelaide Statistical Division.

By further reference to the master matrix, lower order relationships are built up as follows:

- (1) In each column of the matrix underline the second highest correlation coefficient.
- (2) From the original group 1 of the first generation of linkages take each variable in order and look along its row in the matrix for any second order relationships, which are then plotted on the diagram.
- (3) Repeat (2) above for each group in turn.

The results of applying both stages of the above procedures are shown diagrammatically in the accompanying Figure 8.1. Each group, resulting from the application of the procedures described above, has as its nucleus a reciprocal pair of correlated variables with any attached relationships being at successively lower levels of correlation. In five of the eight groups the variables comprising the nuclear reciprocal pair are in fact alternative measures of a single characteristic. These were selected in this way initially (as has been discussed already in this chapter in Sections 8.2.2 and 8.2.3) in order to attempt evaluation of which measure in each pair or group was the more sensitive to variation in the dependent variable, that is, which independent variable correlates most highly with the dependent variable.

In Group 1 three general measures of the distribution of age in the population were used. A perfect correlation was recorded between X_6 , age structure (after Coulson), and X_2 mean age of the total population. The third measure, X_1 age differential, was almost

as strongly, but negatively, related to the other two variables. Related in turn to X_1 is X_5 , dependent children, with a strongly positive score. Index X_3 , mean age of adults, and Index X_4 , child-woman ratio, also contain age components and are related to X_2 . Second and third order relationships with age were recorded with rates of net migration, percentage non-movers and Australian born. Group 2 consists of only three variables each of which is a different measure of the proportion of the work force which is "employers or self-employed". Group 3 is no more than a highly correlated reciprocal pair of variables concerned with absolute numbers actually registered as electors or eligible to be so registered. Group 4 is largely concerned with the geometry of the electoral network. The two elements of the nucleus are measures of distance from different central points while the other variables are derivatives of distance. Group 6, which has but two variables, measures separately marital status of the two sexes. The spatial differences prove to be small. Group 5, consisting of only two highly correlated variables, concerns high socio-economic status, estimated by the surrogates of (1) proportions of the work force in professional or administrative jobs, and (2) proportions of the adult population with tertiary qualifications. Groups 7 and 8 are concerned with types of housing, tenancy and movement rates. The strongest relationship is between the private house index and owner occupancy which in turn relates negatively to tenancy with the State Housing Trust. The reciprocal relationship at the core of Group 8 is a negative one between population turnover and private home index which includes occupancy of all dwellings except flats and home units.

The following is one interpretation of the way the objectively defined groups of variables relate together. Age is the component common to all factors in the central group, which itself relates in approximately descending order to the following variables: marital status (percentage single persons); spatial attributes (especially population density); percentage employers/self-employed; absolute number of electors. Another 'branch' of relationships between groups is linked with age, through marital status, and is concerned with types of housing, nature of occupancy and socio-economic status according to educational and occupational status.

Although the underlying theme of this chapter is the relationship of a range of independent variables with the two movement indices as dependent variables little reference has been made so far to the dependent variables. This is because both population turnover (X_{25}) and net migration (X_{26}) are subsumed in other groups of relationships where they appear merely as one population characteristic along with a variety of others, suggesting that of themselves the movement indices are not of more than medium importance as population descriptors. However, this in no way detracts from the overall importance of the study of movement as one mechanism by which population characteristics are spatially rearranged, because at this stage in the discussion, relationships are being treated as though static at a particular moment in time, namely at the census.

8.4 COMPARISON OF THREE AUSTRALIAN CORRELATION STUDIES OF POPULATION TURNOVER

It is useful here in discerning the influence of the different

TABLE 8.4

Comparison of ecological correlations between variables in three Australian cities, Brisbane (B), Sydney (S) and Adelaide (A)

VARIABLE ^{1,5}		Case Study	Pt	X ₁	X ₂	X ₃	X ₄	X ₅	X ₆
Pt	Population turnover	B	1.00	-.53	.53	-.72	-.21	-.67	-.70
		S	1.00	-.55	.68	.93	-.68	-.62	
		A	1.00	-.67	.67	-.51	-.37	-.09	-.38
X ₁	Age differential	B		1.00	-.74	.79	-.23	.49	.82
		S		1.00	-.73	-.58	.21	-.05	
		A		1.00	-.88	.53	.30	-.51	.49
X ₂	% single females	B			1.00	-.65	-.13	-.33	-.66
		2 S			1.00	.73	-.62	-.24	
		A			1.00	-.68	-.51	.33	-.53
X ₃	Private single house index	B				1.00	.08	.74	.86
		3 S				1.00	-.68	-.50	
		A				1.00	.89	.00	.45
X ₄	% dwellings owner-occupied	B					1.00	.21	.04
		S					1.00	.75	
		A					1.00	.14	.26
X ₅	% Australian born	B						1.00	.70
		S						1.00	
		A						1.00	-.17
X ₆	Distance from C.B.D.	B							1.00
		4 S							
		A							1.00

Sources:

Brisbane (B) : Moore (1969a) p.23
 Sydney (S) : Sinclair (1975) p.9
 Adelaide (A) : Present writer's processing of data from State Electoral Department (1970-71) and Australian Bureau of Statistics (1971).

Notes:

- The variables are defined in Table 8.2
- Sinclair uses '% single adults'
- Sinclair uses '% flats'
- Sinclair omits this variable
- For practical reasons the variables used in this present study were given different index numbers, and their distribution mapped as shown in Appendix A:
 (Pt) Pt, Fig. A. 26; (X₁) X₁₁, Fig. A.2; (X₂) X₁₁, Fig. A.12; (X₃) X₁₈, Fig. A.19; (X₄) X₁₉, Fig. A.20; (X₅) X₇, Fig. A.8; (X₆) X₂₂, Fig. A.23.

variables to make comparisons between some of the findings in this present case study and those of two Australian examples conducted in similar manner. This discussion is undertaken with some caution following the warning of Yeates (1974, pp 92, 93) concerning "the horrendous difficulties in comparing statistical studies of inter-relations between the same variables in different regions or countries". All three studies involve the use of ecological correlations between population turnover as dependent variable and, with minor differences, the same five or six selected independent variables. The studies may be summarized as follows:

Moore (1969a) studied about one-third (200,000 population) of the city of Brisbane, Queensland, south-east of the C.B.D. Population turnover was derived from 1961 State electoral rolls which listed only British nationals 21 years of age and over. Population and housing information was gathered from the 1961 census in 193 collector's districts which were the areal data units of the study. Distance from the C.B.D. was measured by the surrogate of public transport travel time.

Sinclair (1975) based his Sydney study upon approximately the central two-thirds (1.78 million) of the population of the Sydney Statistical Division, New South Wales. All variables, including population turnover, were from the 1971 census and the spatial units were twenty-eight local government areas. Sinclair omitted a measure of distance and therefore used one less variable than Moore.

This present study is based upon the entire population (842,000) of the Adelaide Statistical Division for which population turnover in fifty electoral subdivisions was derived from State electoral rolls for 1970-71. The population and housing variables were calculated for

electoral subdivisions by re-assembly of 1971 census collector's district data. The variable 'distance from the C.B.D.' was calculated as a straight line between the derived population centroid of each electoral subdivision.

The results obtained in these three studies are shown in the accompanying Table 8.4 and discussed below by taking each variable in turn.

In comparing the results of the three studies it is important to note the two variables defined differently by Sinclair and the one omitted by him. Firstly, instead of 'percentage single females' (X_2) he used 'percentage single adults' thereby allowing the occurrence of a comparative spatial shift in the distribution in any area where single males and females existed in different concentrations. Secondly, Sinclair used 'percentage flats' in place of 'private single house index'. Although these categories of dwellings are discrete they are not the only categories of dwellings used, and are therefore not complementary. It can be expected, therefore, that their respective distributions will differ in non-systematic manner. Finally, Sinclair did not use 'distance from the C.B.D.' as a variable.

8.4.1 Population Turnover

With only one exception there is agreement about the direction of relationships between population turnover and other variables. There is a tendency for higher population turnover to occur in younger populations than in older ones. Unmarried persons, and single females in particular, are strongly associated with high rates of population turnover. Low rates of population turnover tend to occur in areas with high proportions of single private homes but this

is less pronounced in Adelaide than in the part of Brisbane studied. Sinclair showed, in his Sydney study, a very strong positive relationship between turnover rates and percentage flats. The tendency for high owner-occupancy of dwellings to be associated with low turnover rates is strongest in Sydney, much weaker in Adelaide, and even weaker still in Brisbane. Since the data covers such a wide time span it can only be surmised whether such differences exist at present or whether shifts have occurred over time. The one disagreement on population turnover between the three studies involves 'percentage Australian born'. Brisbane and Sydney display strongly negative associations between turnover rates and Australian born thereby suggesting that areas with high proportions of foreign born have high turnover rates. However, Adelaide shows no spatial relationship between the two variables ($r=0.09$), a finding in substantial agreement with that of Stimson and Cleland (1975, p.271) where 'overseas born' and 'intercensal mobility' were shown in Adelaide to have a similar correlation coefficient ($r=-.05$). By way of tentative explanation of the marked difference in the Adelaide case the following suggestions are made. Firstly, both the Brisbane and Sydney studies cover only part of the area of their respective cities while urban Adelaide is covered beyond its spatial limits thereby placing the 'foreign born/Australian born' distribution in differing perspectives in each case. Particular geographic concentrations of foreign born within urban areas may appear less outstanding when viewed in a broader context (see for example Fig. A.8 and also 'Adult aliens', Fig. A.32). On the one hand it may be a fact that foreign born in Adelaide are spatially less concentrated

or segregated than in either Brisbane or Sydney. On the other hand such areas of ethnic concentrations as do exist may have undergone change during the decade so that inter-city comparison by means of data with this time difference is hazardous. For example, children born in Australia to foreign born parents appear in the statistics to 'dilute' the proportion of foreign born. However, the children may well be brought up, and behave, in a manner more akin to their foreign born parents than to 'Australian born'. This is to suggest that with the passage of time the behavioural and statistical differences between ethnic groups in some areas may become blurred without the 'real' situation having changed very markedly.

8.4.2 Other Variables

(a) Index of Age Differential

Study of the relationship of the index of age differential with other variables shows two cases where the Adelaide results are of the opposite sign to those of the Brisbane example. One involves owner-occupancy, and the other, Australian born. In Adelaide there is a moderate tendency, similar to that in Sydney, for the younger population to be resident in owner-occupied accommodation, whereas in Brisbane the opposite is true. The Brisbane case proved the opposite of the writer's expectation (Moore 1969a, p.27) and was reported to be due to a local factor associated with the government Housing Commission. However, in the case of Adelaide it appears that a population subgroup with high dwelling owner-occupancy is parents with children under fifteen years (see X_5 , Fig. A.6). The other difference relates to the age differential

and proportion of the population Australian born. In each of the two cases the relationship was moderately strong, but of opposite sign, while Sydney showed no correlation on the same variables. In Adelaide, at the 1971 census, the tendency was for the younger populations to be associated with lower proportions of Australian born, a fact which implies that higher proportions of foreign born accompany higher proportions of children in the population (a trend in Adelaide also shown by Stimson and Cleland 1975, pp.270-271). The fact that the Brisbane case differed, by showing a strong tendency for both lower age and high proportion of Australian born to occur together, may also be due to some special feature of the particular geographic part selected for study in that city.

All three cities were shown to have a very strong negative association between index of age differential and percentage of single females. This shows that the higher the proportion of single women in an area the less important is the section of the population under 14 years of age in comparison with the section 65 years and over.

In both Brisbane and Adelaide a high positive correlation exists between age differential and the proportion of single private dwellings, showing that the more numerically dominant the group under 15 years in comparison with the elderly, the greater is the proportion dwelling in single private homes. However, in Sydney, where there is a strong negative relationship between flat dwellers and age differential, it appears that the greater the proportion living in flats, the greater is the dominance of the

'65 years and over' group compared with children.

The relationship between age differential and distance from the C.B.D, is strong and positive in both Brisbane and Adelaide, but more so in the former where only part of the urban area was studied. In each case it is clear that there is a strong tendency for the higher proportions of dependent children to be located at greater distances from the C.B.D.

(b) Percentage of single females

The three studies are in substantial agreement over the relationship between single women and private dwellings. Brisbane and Adelaide both have a strong negative relationship between the proportions of single females and of single private dwellings, while Sydney has a strong positive link between single females and flat dwelling. Owner-occupancy is also negatively related to single women, but strongest in Sydney and weakest in Brisbane. In Sydney and Adelaide, areas with high proportions of single women are under-represented by Australian born, whereas in Brisbane the opposite is the case. Such concentrations of single women occur in inner city areas as shown by the high negative correlations between single females and distance from the C.B.D.

In summary, the trend is for single women to live in flats as tenants in areas towards the C.B.D., with the mix of foreign and Australian born depending on the particular city.

(c) Percentage of single private dwellings

The private house index shows considerable variation between

the three case studies, possibly resulting from differences in spatial distribution of housing types. Adelaide has a very high positive correlation between owner-occupancy and single private dwellings, whereas in the Brisbane study no relationship exists. In Sydney there is a strong tendency for owner-occupancy to be low where the proportion of flats is high. The proportion of Australian born is highly positively correlated with single private dwellings in Brisbane, but uncorrelated in Adelaide, whereas in Sydney there is a strong negative relationship between flats and Australian born showing that foreign born and flats are strongly associated. Single private dwellings tend to be located at greater distance from the C.B.D., very strongly so in Brisbane and moderately so in Adelaide.

From the above it may be seen that single private houses in Adelaide are generally owner-occupied by either Australian or foreign born located in increasing proportion toward the urban periphery. In the Brisbane study similar housing is occupied by owners or tenants strongly dominated by Australian born located increasingly towards the city's outer limits. In Sydney flats are predominantly occupied by tenants, a disproportionate number of whom are foreign born.

(d) Dwellings owner-occupied

Owner-occupancy of dwellings is strongly dominated by Australian born in Sydney but only moderately so in Brisbane and weakly so in Adelaide. In Adelaide there is a moderate tendency for owner-occupancy to increase with distance from the centre of the city.

(e) Australian born and distance from C.B.D.

In Brisbane there is a very strong positive relationship between distance from the city centre and the proportion of Australian born showing that this section of the population is increasingly predominant with increasing distance from the C.B.D. The situation is different in Adelaide where there is a slight tendency for foreign born to increase proportionately with distance from the centre of the city.

8.4.3 Summary

The foregoing discussion has shown that population turnover in all three case studies was related negatively to age differential, owner-occupancy, single private dwellings, and distance from the C.B.D., but positively related to single females. The relationship with 'percentage Australian born' was less clear, being zero in Adelaide and negative in both Brisbane and Sydney.

Other relationships of importance between the selected variables were as follows:

- . age differential is negatively related to single females
- . single females are negatively related to both single private dwellings and owner-occupancy
- . percentage Australian born and distance from the C.B.D. are factors which vary from one city to another.

8.5 PARTIAL CORRELATION ANALYSIS

8.5.1 Shortcomings of simple correlation analysis

To this point discussion has been based upon a matrix of

simple correlations which were themselves derived from what, for practical purposes, amounts in the Adelaide study to a total population of electoral movers and a total population of census respondents. Nevertheless, the analysis of variables selected from these populations has been subject to a source of distortion which is potentially considerable but, in this discussion, so far unacknowledged. Siegel (1956, p.223) has warned that when a correlation is observed between two variables, there is always the possibility that the correlation is due to the association between each of the two variables and a third variable. Cooley and Lohnes (1971, pp. 53, 96) have remarked that the elements of a 'system of predictors' interact in a complex fashion and that intercorrelations among elements of a vector variable are the bane of the multivariate researcher's struggle for meaning. Therefore, given the present array of variables and the wish to describe relationships between movement indices as dependent variables and the rest as independent variables, there is reason to question whether the relationships are, in fact, of the kind and degree described in the correlation matrix (Table 8.3).

The problem raised here may be met with two answers. The first answer is concerned with some of the statistical assumptions made about data when they are subjected to correlation and regression analyses (Johnston, 1971a, p.320; Gould, 1970, p.442; Poole and O'Farrell, 1971, p.156). The second answer is concerned with the technique of 'partial correlation' which can be applied to data to eliminate the effects of variation between variables other than the pair under study (Siegel, 1956, p.223).

TABLE 8.5

Partial correlation coefficients between (a) annual index of population turnover and various independent variables and (b) annual index of net migration and the same independent variables, based on electoral subdivisions in the Adelaide Statistical Division

INDEPENDENT VARIABLE	DEPENDENT VARIABLES			
	Population Turnover Partial Corr.	Rank	Net Migra- tion Partial Corr.	Rank
X1 Index of age differential	-.35	15	-.32	7
X2 Mean age of total population	.29	17	.01	26
X3 Mean age of adult population	-.58 *	6	-.20	10
X4 Child-woman ratio	-.42	13	-.53 **	1
X5 Percentage of population 0-15 yrs (dependent children)	.50 *	8	.25	8
X6 Age structure index	-.22	19	.00	27
X7 Percentage of Australian-born in total population	-.33	16	.19	12
X8 Population density (Persons/sq.km.)	-.43	12	.11	14
X9 Percentage of non-movers	.11	25	-.52 **	2
X10 Percentage of adult population with tertiary qualifications	.20	21	.08	20
X11 Percentage of single females	-.39	14	-.34 **	5
X12 Percentage of single males	.19	22	.08	19
X13 Percentage of males who are employers or self-employed	-.11	24	.20	9
X14 Percentage of labour force, employers or self-employed	-.21	20	-.16	13
X15 Percentage of male labour force, employers or self-employed	.14	23	-.10	16
X16 Percentage of employed in pro- fessional or administrative occupations	.03	27	-.11	15
X17 Private home index (excluding flats)	-.10	26	.36 **	4
X18 Separate private house index	.62 *	3	.01	25
X19 Percentage of dwellings owner- occupied	-.66 *	1	-.04	24
X20 Percentage of dwellings occupied by tenants to S.H.A.	-.46	9	-.07	23
X21 Percentage of dwellings unoccupied	.59 *	5	.19	11
X22 Distance from C.B.D. (Km)	-.28	18	-.07	22
X23 Distance from P.C.G. (Km)	.43	11	.09	17
X24 Area of subdivision (Sq Km)	-.64 *	2	-.33	6
PT Percentage annual population turnover	--	-	-.45 **	3
NM Percentage annual net migration	-.45	10	--	-
ER Total on electoral roll	.59 *	4	.08	18
BN British nationals 21 years and over	-.57 *	7	-.08	21

Notes:

1. Degrees of freedom = 22
2. *Significant at better than 0.02 on the two-tailed test
3. ** Significant at .01 or better on the two-tailed test

When applying correlation and/or regression analysis to sample data for the purpose of developing explanations or testing hypotheses it is necessary, because of the underlying theoretical assumptions of the techniques, to ensure that the variables are independent of one another and are linear and normal in their distributions (Poole and O'Farrell, 1971, pp. 148-149). In this present case, however, as already remarked, the information is not taken from a sample but a total population, and the purpose is exploratory and descriptive, without being overtly theoretical or explanatory. Gould (1970, p.442) has pointed out the logical absurdity of treating total populations as samples. He shows that this, in fact, is what is done when application is made to total populations of the same inferential tests of significance as used on samples. If the tests are applied to a total population the associations described cannot be extrapolated according to the purpose of the tests to a larger population, where in fact none exists. Where the purpose is descriptive

"it is not necessary to make any assumptions at all about the form of the distribution, the variability of Y scores within X columns or 'arrays', or the true level of measurement represented by the scores in order to employ linear regression and correlation indices to describe a given set of data."

Hays (1974, p. 636)

However, even with this release from some of the more demanding statistical requirements there is still to be answered the undeniable problem of likely intercorrelation between the "independent" variables when compared separately with the movement indices (Boudon, 1968, p.199). In such circumstances partial

correlation is a useful device (Siegel, 1956, p.223; Hays, 1974, p.710) because it is able to "indicate the intercorrelation between any one independent variable with the dependent variable, with all other independent variables held constant" (Yeates, 1974, p.121).

8.5.2 Application of partial correlation

Partial correlation was applied in the present case using the computer programmes available in the 'Statistical Package for the Social Sciences' (Nie, et al, 1970, pp. 157-173). The existing matrix (Table 8.3) of Pearson Correlations between twenty-eight variables was used as input. Two separate analyses were conducted, each with a different dependent variable, namely, population turnover and net migration. The following facility of the programme was of special value:

"When a value equal to the number of control values is specified, a single partial (of Nth order where N is the number of control variables) will be produced for each pair of variables specified by the correlation list using ALL the control variables simultaneously as the control." (Nie, et al, 1970, p. 163)

The results of this application are shown in the accompanying Table 8.5 which shows for each variable the value of the partial correlation, and an indication of the level of significance.

8.5.3 Population turnover

Areas with high rates of population turnover are shown by the partial correlation analysis to have a high probability, which declines successively down the list, of being associated with the

following characteristics: (Maps of distributions in Appendix A)

- a low level of owner-occupancy of dwellings (X_{19} , Fig. A 20)
- a high incidence of separate private dwellings (X_{18} , Fig. A 19)
- a relatively high proportion of unoccupied dwellings (X_{21} , Fig. A 22)
- an electoral subdivision of small area (X_{24} , Fig. A 25)
- a high absolute number of electors on the roll (ER, Fig. A 28)
- a low mean age of its adult population (X_3 , Fig. A 4)
- a moderately high proportion of dependent children (X_5 , Fig. A 6)

The reverse levels of the same characteristics may be presumed to occur in areas with low rates of annual population turnover, which is to suggest that 'stable' populations tend to occur in areas with the following characteristics:

- high levels of owner-occupancy of dwellings (X_{19} , Fig. A 20)
- low incidence of separate private dwellings (X_{18} , Fig. A 19)
- low proportion of unoccupied dwellings (X_{21} , Fig. A 22)
- electoral subdivisions of larger area (X_{24} , Fig. A 25)
- low absolute number of electors on the roll (ER, Fig. A 28)
- high mean age of its adult population (X_3 , Fig. A 4)
- a moderately low proportion of dependent children (X_5 , Fig. A 6)

The combination described above of small area electoral subdivisions, with high numbers on the electoral rolls for areas of high population turnover, locates such areas mainly in the inner and middle suburbs. It is here that the population combines young adults, a moderate proportion of women with dependent children and a high proportion of tenants living in separate private dwellings.

8.5.4 Net Migration

Partial correlation analysis reveals that high annual rates of net migration are likely to be associated with the following characteristics in descending order of probability:

- . low child-woman ratio (X_4 , Fig. A 5)
- . low percentage of non-movers (high percentage of movers) in the intercensal period (X_9 , Fig. A 10)
- . low annual rate of population turnover (Pt, Fig. A 26)
- . a moderately high proportion of dwellings "private homes", that is, not flats (X_{17} , Fig. A 18)
- . relatively low percentage of single females (X_{11} , Fig. A 12)

By reversing the above findings the following characteristics describe areas of low, often negative, rates of net migration:

- . high child-woman ratio (X_4 , Fig. A 5)
- . high percentage of non-movers (low percentage of movers) in the intercensal period (X_9 , Fig. A 10)
- . high annual rates of population turnover (Pt, Fig. A 26)
- . moderately low proportion of private homes, that is, a relatively higher proportion of flats (X_{17} , Fig. A 18)
- . a relatively high percentage of single females (X_{11} , Fig. A 12)

The above, seemingly contradictory, combination of low population turnover and low percentage of non-movers is understandable when it is realized that high rates of net migration occur in newly developing areas of the city. It can be expected, therefore, that at the census many people in such areas will be at addresses

different from those of the previous census, and therefore defined as "movers". However, few residents (electors) leave the newly developing areas which therefore have a low rate of population turnover. The low child-woman ratio is accounted for by the relatively low mean age of adults (Index X_3) suggesting that few families are yet complete in the newer areas. This is in contrast to the areas of low, or even negative, rates of net migration where mean age is higher and families presumably completed as suggested by the high child-woman ratio. The high population turnover in these latter areas may be accounted for, in part, by the leaving-home of young adults and the high turnover of flat-dwellers who are more numerous in such areas (complement of X_{17}).

Partial correlation analysis has been used above in the determination of the strength of relationships between the dependent variables, net migration and population turnover, considered separately with each member of a set of independent variables. A limitation of the partial correlation technique is that independent variables are considered only singly thereby omitting the possible influence of combinations. Coulson (1968, p. 171) in such circumstances utilized the technique of multiple correlation and multiple regression. His main purpose was to reduce progressively the full set of his original independent variables while retaining the highest possible predictive power. This technique will now be discussed before application to the present data.

8.6 MULTIPLE REGRESSION

Blalock (1972, p.429) points out that multiple regression is usually employed when attempting to predict a single dependent variable from any number of independent variables considered simultaneously. However, it has been observed that when the technique is used descriptively rather than theoretically on a given set of data, whether a simple or a total population,

"it is not necessary to make any assumptions at all about the form of the distribution, the variability (of scores) or the true level of measurement represented by the scores ..."

(Hays, 1974, pp. 635-636).

A further benefit derives from the use of the variation of the technique known as "stepwise" multiple regression. It is one of a number of strategies enabling determination of the relative importance of different variables. Stepwise multiple regression, according to Yeates (1974, pp. 120-212), is really a search procedure by which variables are entered one at a time into the regression equation in an order determined by the level of the individual variable's contribution to the total variance, the greatest contributor being entered first and others entered in decreasing order of contribution. Stepwise multiple regression was applied to the data of the present study by means of the computer programme available in the 'Statistical Package for the Social Sciences' (Nie, et al, 1970, pp.174-195). The purpose was to continue both the exploration and description of relationships between the same sets of variables already under review.

The independent variables were examined as two separate sets to discover the contribution of individual variables to the total

TABLE 8.6

Multiple Correlation (R) between population turnover and seven independent variables.

DEPENDENT VARIABLE :			POPULATION TURNOVER (PT)						
Step	Variable Entered or removed	F to enter or remove	Significance	Multiple R	R Square	R Square Change	Simple R	Overall F	Significance
1	X17 Private home index	73.290	.000	.777	.604	.604	-.777	73.290	.000
2	X1 Index of age differential	4.863	.032	.801	.641	.037	-.673	42.026	.000
3	X7 % Australian-born in total population	5.451	.105	.824	.679	.038	.085	32.488	.000
4	X23 Distance from P.C.G. (Km)	2.738	.105	.835	.698	.018	-.290	25.971	.000
5	X22 Distance from C.B.D. (Km)	7.179	.010	.860	.740	.042	-.379	25.066	.001
6	NM % annual net migration	11.346	.002	.891	.794	.054	-.492	27.691	.003
7	X9 % of non-movers	5.133	.029	.904	.817	.022	-.139	26.750	.003

NOTES:

- 25 variables in equation
- Regression F level = .02
Tolerance level = .0005

variation in each of the two dependent variables, population turnover (Pt) and net migration (Nm). The data in-put was the same matrix of Pearson Correlation Coefficients used in the Partial Correlation analysis. The storage and retrieval of these elements was initiated by utilizing optional features of the S.P.S.S. programme. Accordingly independent variables were entered into the regression equation one by one beginning with the variable with the highest contribution to total variability in the dependent variable. No further variables were added beyond $F < .01$.

The results of the application are set out below and are separately discussed under the headings of Population Turnover (8.6.1) and Net Migration (8.6.2).

8.6.1 Population Turnover

The independent variables ranked amongst the top seven, together account for 81.7 per cent of the variation in population turnover rates at high overall levels of significance, better than .003, as shown in the accompanying Table 8.6.

The largest amount of variation (60.4 per cent) is accounted for by the Private Home Index (Index X_{17}) which excludes flats and is negatively related to population turnover, thereby suggesting that the percentage of flats in an area may be the best positive predictor of rates of population turnover (see Sinclair, 1975, p.9; Stimson and Cleland, 1975, pp. 104, 105, 267).

The Index of Age Differential (X_1) adds another 3.7 per cent

TABLE 8.7

Multiple correlation (R) between net migration and eight independent variables

DEPENDENT VARIABLE : NET MIGRATION (NM)									
Step	Variable Entered or removed	F to enter or remove	Signifi- cance	Multiple R	R Square	R Square Change	Simple R	Overall F	Signifi- cance
1	X3 Mean age adult population	75.248	.000	.781	.611	.611	-.781	75.248	0
2	X19 % dwellings owner-occupied	14.873	.000	.839	.704	.094	.510	55.935	.000
3	X9 % non-movers	16.929	.000	.885	.784	.080	-.682	55.571	.000
4	PT % annual population turn- over	23.069	.000	.925	.857	.073	-.492	67.442	.000
5	X11 % single females	5.449	.024	.934	.873	.016	-.685	60.378	.001
6	X1 Index of age differential	6.985	.011	.944	.891	.018	.642	58.323	.001
7	X21 % dwellings unoccupied	5.154	.028	.950	.903	.012	.248	55.557	.003
8	X4 Child-woman ratio	7.282	.010	.958	.917	.015	.757	56.793	.003

NOTES:

1. 22 variables in equation
2. Regression F level = .01 (Default value)
Tolerance level = .001 (Default value)

to the variation in population turnover with which it is highly correlated negatively. High positive age differentials describe a predominance of dependent children over retired people and in the present case indicates a tendency for the younger population to be associated with lower annual turnover rates.

Percentage Australian born (X_7) in the population adds a similar amount to the variation in population turnover but is only slightly positively related to it. Distance from the C.B.D. (X_{22} , 4.2 per cent) and distance from the P.C.G. (X_{23} , 1.8 per cent) are both negatively related to the turnover rates indicating a decrease with increasing distance from the inner areas. Annual net migration rates (N_m) add 5.4 per cent explanation to the population turnover with which the relationship is strongly negative. The percentage of non-movers (X_9) accounts for 2.2 per cent of the turnover rates but is only weakly negatively related.

8.6.2 Net Migration

Compared with population turnover there is a slight tendency for more independent variables to share in "explanation" (Tab.8.7), but predominance of a single variable is still apparent. The top eight variables together account for 91.7 per cent of the total variance, while X_3 (mean age of the adult population) alone accounts for 61 per cent, based on a simple correlation of -0.78 , making clear the strong tendency for areas of high net migration to be comprised of young populations. This result was to have been expected from other trends already described. Another 9.4 per cent is added by X_{19} (percentage of dwellings owner-occupied) and with its positive

relationship to net migration suggests that high owner-occupancy accompanies high rates of net migration. X_9 (percentage of non-movers, "stayers") accounts for a further 8 per cent of variation and is negatively related to net migration, implying that areas of greatest growth tend to have low levels of "stayers" while areas of low (even negative) net migration have high proportions of stayers. This seemingly paradoxical combination is discussed in section 8.5.4.

Population turnover (Pt) as an independent variable contributes 7.3 per cent of the variation in net migration with which the relationship is moderately negative. X_{11} (percentage single females) contributes 1.6 per cent to net migration and is strongly negatively related revealing that areas of high net migration have low proportions of single females (presumably they have high proportions of married women).

The three remaining variables selected for comment each contribute somewhere between one and two per cent to total variation, and in each case is positively related to the dependent variable. X_1 (age differential) reflects the same trend shown by X_3 , namely the predominance of younger populations in areas of high net migration. X_{21} (percentage of dwellings unoccupied) reveals a weak tendency for areas of high net migration to have a high proportion of empty dwellings. It may be presumed from the geographic location that many of these are newly constructed and awaiting first occupants. X_4 (child-woman ratio) shows an expected strong tendency for high net migration to occur in areas accompanying high ratios of children under 5 years to women of child-bearing age.

Age is the characteristic which emerges as paramount and fundamental. It was shown that areas of high net migration are typically dominated by young married adults with young children and new owner-occupied dwellings. Areas of low (even negative) net migration have older populations, most members of which are non-movers, although there is a highly mobile element present. Such areas also have fewer owner-occupied dwellings, a higher proportion of single females, a low child-woman ratio and relatively few unoccupied dwellings.

8.7 CHAPTER EIGHT SUMMARY AND CONCLUSIONS

The purpose of this chapter was to search for systematic relationships between each of the two indices of population movement previously described (population movement and net migration) and a selection of population and housing variables. The latter two sets were selected partly with a view to enabling comparison of results with previous studies in Brisbane and Sydney.

The method of analysis adopted after examination of alternatives involved the compilation of a correlation matrix showing Pearson Correlation Coefficients between a total of twenty-eight different variables including the movement indices. This information was then used in the construction of simple 'linkage analysis' diagrams to identify groups of related variables. This was followed by application to the same data of 'partial correlation analysis' which enabled comparison of pairs of variables while controlling for the influence of all other variables. Finally, 'multiple regression' analysis of the same data was used to identify which of the selected independent

variables had the largest share in the total relationship with the dependent movement indices.

Linkage analysis showed a central core of age-related variables with associated clusters of marital status, housing type and occupancy, employer and socio-economic status, and network geometry. The movement indices were unobtrusively embedded amongst the other variables suggesting that in a broad array of variables viewed at a single time, movement rates prove to be of little importance in the total distribution of population characteristics.

Despite some relatively minor differences, which resulted from the individual urban morphologies, there were distinct similarities in the results between the studies in ecological correlations involving six independent variables in Brisbane, Sydney and Adelaide. Population turnover was found to relate strongly and negatively to indices of private single houses (or positively to 'flats') and population age differential. Moderately negative relationships were found with owner-occupancy and, in two cities only, with Australian born. A strong positive association was revealed between rates of population turnover and percentage single females.

Analysis of a larger number of variables by partial correlation confirmed the importance of the same variables but changed the relative emphases. Owner-occupancy, mean age of adults, areal size of data units and number of British nationals all related negatively with population turnover, while positive correlations were found with separate private houses, percentage of dependent children and total on the electoral roll. Net migration was negatively related to the

child-woman ratio, percentage of non-movers, rates of population turnover, and percentage of single females; and positively associated with the private home index (excluding flats).

Multiple regression showed that in population turnover the most important single variable (highest coefficient of determination or R squared) was the private home index (negative relationship), followed by index of age differential, Australian born and distance from the P.C.G. Net migration was best 'explained' by mean age of adults, followed by percentage of dwellings owner-occupied, percentage of non-movers in the population and rates of population turnover.

8.8 THESIS SUMMARY AND CONCLUSIONS

The following summary of this study is divided into three sections whose contents are here outlined.

(a) Major Intent and Findings (section 8.8.1)

The original aims and questions for investigation are reviewed for comparison with actual findings, all of which were detailed in earlier chapters.

(b) Implications for Further Research (section 8.8.2)

Suggestions for further work mentioned separately in various earlier discussions are brought together under this heading to argue the need for continued monitoring of Adelaide's intra-urban migration and for development of theoretical perspectives to integrate empirical studies.

(c) Summary Evaluation (section 8.8.3)

This section restates the major limitations of the study and

points out its special contribution to the extension of geographic knowledge about residential change in urban areas.

8.8.1 Major Intent and Findings

Following a brief evaluation of the movement data, the two statements of 'major intent' from chapter 2 are reiterated in order to compare the findings which resulted from investigations to answer the initial questions.

The South Australian electoral roll, used as the data source on residential movement of electors, was shown by its high correlation with suitable information from the Australian census, to be reliable for this purpose. Spatial variation in the margin of difference between the two sources was apparent but explicable in broad terms by variations in the age distribution of the population.

The first intent was to describe for a selected period the dimensions and spatial characteristics of intra-urban migration in Adelaide. Data from the electoral rolls of the fifty subdivisions in Adelaide over the fifteen months March 1970 to June 1971, were used as the basis for the study. Residential transfers of electors were used in two ways: firstly in the generation of indices to express annual rates of movement (population turnover and net migration) originating within electoral subdivisions, and secondly, by considering subdivisions as a network of points, to describe the number, distance and direction of transfers according to the relative location within the urban area of both places of origin and of destination. It was found that there are considerable systematic

differences in the characteristics of intra-urban movements depending where they originate within the total urban area. Rates of both population turnover and net migration were shown to be related to distance from the C.B.D. and inversely related to each other. Population turnover was highest in inner urban areas, while net migration was highest in the outer urban areas. The former was related to young single adults and older adults, whereas high net migration was accompanied by young married couples with some young children. These findings are in general agreement with those in Brisbane by Moore (1966b).

Movers, considered in aggregate, displayed a strong tendency to transfer over short distances, with about thirty per cent covering less than three kilometres, and seventy per cent less than ten kilometres. However, the actual distance moved by an elector depended upon the location of his originating residence with reference to the city centre. The shortest moves tended to be initiated in inner areas and the longer ones in outer areas. Furthermore, the range of distances covered by movers from a given origin showed a similar variation according to its position in the total urban context. The broad patterns conform with findings reported by Morrill (1963) and Clark (1970).

Direction of outmovement was analysed with reference to the C.B.D. as the functional node of the urban area. Techniques specially devised for this present study enabled generalized expression of the directional characteristics of aggregations of out-movements. As expected, movements were not random in arrangement

but displayed zonal differences approximately concentric in distribution as proposed by Adams (1969). However, the preferred destinations resembled the patterns proposed by Clark (1970 and 1971) rather than those by Adams (1969). Transfers from the inner zone were mainly lateral in orientation, short and uniformly scattered in all directions. Movers from the middle suburbs, where the biggest proportion of intra-urban transfers originated, travelled further and either toward the C.B.D. or laterally, using a wide range of destinations. The outer suburbs generated proportionately fewer transfers which covered longer distances, and were oriented toward the C.B.D. in strongly focussed streams with comparatively few of the available urban destinations used.

The second of the two major intents expressed in chapter two was to relate patterns of intra-urban migration to selected population characteristics in order to suggest some tentative explanations for the patterns observed. Twenty-six variables were utilized, mostly from census data, in correlation analyses to discover which factors were most closely related to movement indices.

Systematic spatial variations were found to exist in the Adelaide area between annual indices of residential movement and certain population and housing variables. Important associations were recorded with age-related variables, marital status, type of housing and nature of occupancy. Population turnover rates in particular were associated with low rates of owner-occupancy, and high proportions of both young adults and flats (low proportion of private houses was the index used). High rates of net migration

were associated with a low mean-age of adults, a low child-woman ratio, and a high proportion of owner-occupancy of dwellings. Levels of ethnicity and socio-economic indicators did not rank among the significant factors in accounting for population movement rates.

One specific question which it was hoped to answer in this study still remains substantially unanswered: "To what extent is the socio-economic status of sub-areas of the city maintained or changed through intra-urban migration?" Although a substantial basis for providing the answer is here established, further research is necessary to reach the intended goal.

8.8.2 Implications for Further Research

This thesis has highlighted the need for further research in the field of intra-urban migration. At some stages the needs have emerged as direct and clear, at others, as by-products or alternatives to actions taken in the course of the study. It was emphasized at the beginning, that the shortness of the time-span to be studied made trend analysis impossible. The results make even clearer the value of some form of monitoring, either continuous or at regular time intervals, of data on the residential movement of population as an aid to social planning based upon observed and anticipated trends in population change.

Analysis was based almost entirely upon out-migration from sub-areas. It was pointed out that the same data-matrix transposed may be viewed as in-migration. Comparative analysis of the two sets

of flow data can be expected to yield information about the level and kind of change taking place in the sub-areas as a result of differences in the nature and volume of in and out-flows of population. Assessment of trends logically follows from such analysis.

Residential movement within electoral subdivisions was examined only briefly even though it comprised more than one-fifth of all transfers within the study area. This body of information warrants closer study to discover, amongst other things, whether there is a minimum threshold distance people perceive as necessary to transfer in order to justify the effort of moving. Another matter worthy of examination is the degree to which population and behavioural differences within subdivisions were disguised by assumptions of internal homogeneity.

Several other behavioural matters have been suggested for investigation as a result of findings in this study; for example, it is of interest to discover the extent to which movers change status (say, socio-economic, marital or family) on transfer, or alternatively, take pre-existing characteristics unaltered with them. The fact that 85 per cent of all residential out-movement generated within the study area also terminates there raises the question of whether non-metropolitan populations also behave on transfer as though doing so within an almost closed system. Inherent in this comparison of metropolitan and non-metropolitan populations is the question of whether there are differences in their respective rates of residential mobility. Another omitted, but extremely important, subgroup of the population is 'aliens' who, by definition, are not electors. The movement patterns of both urban aliens and

urban electors may exercise reciprocal influences upon one another through the concentration or dispersal, segregation or assimilation of the various minority groups comprising aliens. Although in the Adelaide case aliens are proportionately small, they are likely to be an important part of the total residential movement in the urban area and therefore their movements should be researched to fill the gaps in this present study.

Two spatial aspects of city structure have been specifically suggested for further investigation. Firstly, the identification of nine roughly equal 'key areas' in the movement network suggested the existence of a kind of hierarchy of 'natural areas of community interest' (section 5.2.3). This should be checked for persistence in later migration studies and also for concomitance with the distribution of other sociological measures. Secondly, when a broad, summarizing overview was taken of the directional patterns of movement between four major sub-regions of the city, it appeared that, though near equilibrium resulted, there was a small surplus of out-movement from region to region in a way which seemed to suggest a slight propensity in the overall movement pattern to clockwise movement. Whether or not this is a fact, and of any importance, could be determined by further research, particularly of additional time sequences of intra-urban residential movement.

Some special techniques have been developed in the course of this research. For example, the total procedure followed to calculate centroids, and measures of distance and direction between those points considered as an urban network, was independently evolved specially for this study. However, another geographic user

(Clark, 1971) has since been found to have already confirmed the utility of the basic technique. Less well established are the techniques employed to describe directional aspects of out-migration: firstly, dominant direction of out-movement, and secondly, the 'index of concentration' to describe the relative directional spread of out-flows. Though effective in the present context, further experimentation could lead to improvements and in particular to a more general measurement scale for the Index of Concentration.

The described patterns of distances and directions of intra-urban migration are the accidental by-products of aggregations of individual human actions. They have been the cumulative outcome of multitudes of separate decisions and actions, the major intent of which has not been considered in this study. The decision-making process and associated search procedures, as the predecessor of the act of changing residence, constitute an important section of intra-urban migration. The motivational aspect of this phenomenon is perhaps the most complex and still requires much more study, especially in the Australian context where little work has been done. It is hoped that this present study may provide a basis for research into this aspect so far almost totally neglected in Adelaide, for, as expressed by Boyce (1969, p.22)

'The missing link in most approaches is the process of residential mobility itself. Specifically how and why do people change residence?'

8.8.3 Summary Evaluation

Emphasis in this study has been upon residential out-movement of electors, to the exclusion of other sections of the population, from fifty urban electoral subdivisions which differ considerably from each other in size, a fact which led to some problems of distortion in inter-area comparisons.

Electoral rolls in South Australia were shown to be a valuable source of residential transfer data which, despite handling problems and limitations, is both reliable and of considerable accuracy where this can be assessed. The time span covered by the movement study was necessarily short thereby rendering it impossible to show trends for change through time. Analysis of residential movement within the single urban area of Adelaide was generally limited to that taking place between each of the fifty electoral subdivisions of which it is comprised. Annual rates of movement were expressed in terms of standard indices of net migration and population turnover, and their distributions were mapped. These indices provided the basis for a search, using correlation analyses, for related population and housing measures in an effort to find clues for future investigation into forces underlying the movement patterns.

The patterns described for Adelaide, though of a dynamic human-movement network, are merely the state of affairs at 'a given moment in time', and in the absence of similar descriptions for other times with which to make comparisons, no satisfactory extrapolations can be made about either past or future dispositions of aggregated residential transfers. Nevertheless, this study has provided the important first step toward the much-to-be-desired

monitoring of local trends in intra-urban migration. It has demonstrated both the utility and the efficacy for such a study of a readily available official data source. Furthermore, it has shown pertinent ways of processing and representing the data, and in two cases developed special techniques in response to particular need.

Although not specifically included in the initial aims of this work, circumstance has decreed that a major thrust of this thesis has been the pioneering and demonstration of techniques to summarize aggregations of intra-urban migrations in order to achieve an holistic view of movements within a single urban system. Despite the fact that regularities in the particular data set have been clearly identified they cannot logically be seen as constituting generalizations for other cases of intra-urban migration. Such generalizations can be made validly only by using the results of the initial study, as pointed out by Moore (1969b, p. 115) 'to form hypotheses to be tested in other empirical situations.'

REFERENCES

- ABLER, R., ADAMS, J.S. and GOULD, P. (1971): Spatial Organization. The Geographers View of the World, Prentice-Hall, London.
- ADAMS, J.S. et al (1973): 'Intra-urban Migration'. Annals, Association of American Geographers, vol. 63, no. 1, pp. 152-155.
- BAGLEY, C. and BOSHIER, R. (1975); 'Demographic Predictors of Conservatism and Racial Prejudice'. The Australian and New Zealand Journal of Sociology, vol. II, no. 2, pp. 65-68.
- BERRY, B.J.L. and HORTON, F.E. (1970): Geographic Perspectives on Urban Systems with Integrated Readings, Prentice-Hall, New Jersey.
- BERRY, B.J.L. (1971): 'Introduction: The Logic and Limitations of Comparative Factorial Ecology'. Economic Geography vol. 47, no. 2 (Supplement), pp. 209-219.
- BLALOCK, H.M. (1972): Social Statistics, McGraw-Hill, Kogakusha, Tokyo.
- BLALOCK, H.M. and BLALOCK, A.B. (1968): Methodology in Social Research, McGraw-Hill, New York.
- BOUDON, R. (1968): 'A New Look at Correlation Analysis' in H.M. Blalock and A.B. Blalock Methodology in Social Research, McGraw-Hill, New York.
- BOURNE, L.S. (1971): 'Physical Adjustment Processes and Land Use Successions, a Conceptual Review and Central City Example'. Economic Geography, vol. 47, no. 1, pp.1-15.
- BOYCE, R.R. (1969): 'Residential Mobility and Its Implications for Urban Spatial Change'. Proceedings, Association of American Geographers, vol. I, pp. 22-26.
- BROWN, L.A. and HORTON, F.E. (1970): 'Social Area Change: An Empirical Analysis'. Urban Studies, vol. 7, no. 3, pp. 271-288.
- BROWN, L.A. and LONGBRAKE, D. (1969): 'On the Implementation of Place Utility and Related Concepts: the Intra-urban Migration Case', in K.R. Cox and R.G. Colledge (ed) Behavioural Problems in Geography: A Symposium, Studies in Geography, no. 17, Dept. of Geography, Northwestern University, Evanston, Illinois.

- BROWN, L.A. and LONGBRAKE, D. (1970): 'Migration Flows in Intra-urban Space: Place Utility Considerations'. Annals, Association of American Geographers, vol. 60, no. 2, pp. 368-384.
- BROWN, L.A. and MOORE, E.G. (1970): 'Intra-urban Migration: A Perspective'. Geografiska Annaler, Series B, vol. 52, no. 1, pp. 1-13.
- BROWN, L.A., ODLAND, J. and GOLLEDGE, R. (1970): 'Migration, Functional Distance, and the Urban Hierarchy'. Economic Geography, vol. 46, no. 3, pp. 472-485.
- BRYSON, L. and THOMPSON, F. (1972): An Australian Newtown. Life and Leadership in a New Housing Suburb, Penguin Books.
- CASETTI, E. (1971): 'Equilibrium Land Values and Population Densities in an Urban Setting'. Economic Geography, vol. 47, no. 1, pp. 16-20.
- CAVE, P.W. (1969): 'Occupancy Duration and the Analysis of Residential Change'. Urban Studies, vol. 6, no. 1, pp. 58-69.
- CLARK, S.D. (1966): The Suburban Society, University of Toronto Press, Toronto.
- CLARK, W.A.V. (1970): 'Measurement and Explanation in Intra-urban Residential Mobility'. Tijdschrift Voor Econ. En. Soc. Geog., vol. lxi, no. 1, pp. 49-57.
- CLARKSON, J.D. (1970): 'Ecology and Spatial Analysis'. Annals, Association of American Geographers, vol. 60, no. 4, pp. 700-716.
- COMMONWEALTH BUREAU OF CENSUS AND STATISTICS (1971): Census of Population and Housing Magnetic Tape Summaries of Collector's District Data, Canberra.
- CONGALTON, A.A. (1969): Status and Prestige in Australia, Cheshire, Melbourne.
- COOLEY, W.W. and LOHNES, P.R. (1971): Multivariate Data Analysis, John Wiley and Sons, New York.
- COULSON, M.R.C. (1968): 'The Distribution of Population Age Structure in Kansas City'. Annals, Association of American Geographers, vol. 58, no. 1, pp. 155-176.
- DAVIES, W.K.D. (1972): 'Data Analysis in Urban Geography'. Geography, vol. 57, no. 256, pp. 196-206.
- ERICKSON, R.A. (1975): 'The Spatial Pattern of Income Generation in Lead Firm, Growth Area Linkage Systems'. Economic Geography, vol. 51, no. 1, pp. 17-26.

- FREDLAND, D.R. (1974): Residential Mobility and Home Purchase, Lexington Books, D.C. Heath Ltd, Farnborough.
- GIBSON, J.G. (1967): 'The Residential Pattern and Mobility of Dutch and Greek Migrants in the Adelaide Metropolitan Area'. Unpublished thesis, Dept. of Geography, Adelaide University.
- GOLDSTEIN, S. and MAYER, K.B. (1965): 'Demographic Correlates of Status Differences in a Metropolitan Population'. Urban Studies, vol. 2, no. 1, pp. 67-84.
- GOULD, P. (1970): 'Is Statistix Inferens the Geographical Name for a Wild Goose?'. Economic Geography, vol. 46, no. 2 (Supplement), pp. 439-448.
- HALL, F.L. (1973): Location Criteria for High Schools, Research Paper Series no. 150. Dept. of Geography, University of Chicago, Chicago.
- HARTSHORN, T.A. (1971): 'Inner City Residential Structure and Decline'. Annals, Association of American Geographers, vol. 61, no. 1, pp. 72-96.
- HAYNES, K.E. and RUBE, M.I. (1973): 'Directional Bias in Urban Population Density'. Annals, Association of American Geographers, vol. 63, no. 1, pp. 40-47.
- HAYS, W.L. (1974): Statistics for the Social Sciences (2nd edition), Holt, Rinehart and Winston, London.
- HENDERSON, F.M. and VOILAND, M.P.J. (1975): 'Some Possible Effects of Energy Shortages on Residential Preferences'. The Professional Geographer, vol. xxvii, no. 3, pp. 323-326.
- HERBERT, D. (1972): Urban Geography. A Social Perspective, David and Charles, Newton Abbot, Devon.
- HERBERT, D.T. (1973): 'Residential Mobility and Preference: A Study of Swansea', In Social Patterns in Cities, edited by B.D. Clark and M.B. Gleave, Institute of British Geographers, Special Publication No. 5, London.
- HOLMES, J.H. (1971): 'External Commuting as a Prelude to Suburbanization'. Annals, Association of American Geographers, vol. 61, no. 4, pp. 774-790.
- HOOVER, E.M. (1971): An Introduction to Regional Economics, Alfred A. Knope, New York.
- HORTON, F.E. and REYNOLDS, D.L. (1970): 'Intra-urban Migration and the Perception of Residential Quality'. In Population and Migration in an Urban Context: A Spatial Perspective (Paper No. 4), Meetings of the Population Association of America.

- HORTON, F.E. and REYNOLDS, D.R. (1971): 'Effects of Urban Spatial Structure on Individual Behaviour'. Economic Geography, vol. 47, no. 1, pp. 36-48.
- HUGO, G.J. (1971a): 'Internal Migration in South Australia 1961-1966' Unpublished M.A. thesis, Dept. of Geography, Flinders University, S.A.
- HUGO, G.J. (1974): 'Internal Migration and Urbanization in South Australia'. In Urbanization in Australia, edited by I.H. Burnley, Cambridge University Press, pp. 81-98.
- HUMPHREYS, J.S. (1973): 'Intra-urban Migration and Residential Structure' No. 6, Monash Publications in Geography, Dept. of Geography, Monash University, Melbourne.
- JOHNSTON, R.J. (1966b): 'The Population Characteristics of the Urban Fringe: A Review and Example'. Australian and New Zealand Journal of Sociology, vol. 2, no. 2, pp. 79-93.
- JOHNSTON, R.J. (1968): 'Choice in Classification: The Subjectivity of Objective Methods'. Annals, Association of American Geographers, vol. 58, no. 3, pp. 575-589.
- JOHNSTON, R.J. (1969a): 'Some Tests of a Model of Intra-urban Population Mobility: Melbourne, Australia'. Urban Studies, vol. 6, no. 1, pp. 34-57.
- JOHNSTON, R.J. (1969b): 'Population Movements and Metropolitan Expansion: London 1960-61'. Transactions of the Institute of British Geographers, no. 46, pp. 69-91.
- JOHNSTON, R.J. (1971a): 'Some Limitations of Factorial Ecologies and Social Area Analysis'. Economic Geography, vol. 47, no. 2, (Supplement) pp. 314-323.
- JOHNSTON, R.J. (1971b): Urban Residential Patterns, An Introductory Review, G. Bell and Sons, London.
- JOHNSTON, R.J. (1972): 'Activity Spaces and Residential Preferences: Some Tests of the Hypothesis of Sectoral Mental Maps'. Economic Geography, vol. 48, no. 2, pp. 199-211.
- JOHNSTON, R.J. (1973a): Spatial Structures: Introducing the Study of Spatial Systems in Human Geography, Methuen, London.
- JOHNSTON, R.J. (1973b): 'Residential Differentiation in Major New Zealand Urban Areas: A Comparative Factorial Ecology'. In Social Patterns in Cities, edited by B.D. Clark and M.B. Gleave, Institute of British Geographers, Special Publication No. 5, London.

- JONES, F.L. (1969): Dimensions of Urban Social Structure. The Social Areas of Melbourne, Australia, A.N.U.Press, Canberra.
- LEE, E.S. (1966): 'A Theory of Migration'. Demography, vol. 3, pp. 47-57.
- LEE, E.S. and BARBER, G.P. (1966): 'Differentials in Spatial Mobility'. In National Vocational-Technical Education Seminar on Occupational Mobility and Migration, edited by H.G. Beard, Center Seminar and Conference Report No. 2, North Carolina State University, North Carolina.
- McQUITTY, L.L. (1957): 'Elementary Linkage Analysis for Isolating Orthogonal and Oblique Types and Typal Relevancies'. Educational and Psychological Measurement, vol. 17, pp. 207-229.
- MARTIN, J.I. (1967): 'Extended Kinship Ties: An Adelaide Study'. Australian and New Zealand Journal of Sociology, vol. 3, no. 1, pp. 44-63.
- MARTIN, J.I. (1970): 'Suburbia: Community and Network'. In Australian Society A Sociological Introduction, edited by A.F. Davies and S. Encel, Cheshire, Melbourne.
- MEYER, D.R. (1971): 'Factor Analysis Versus Correlation Analysis: Are Substantive Interpretations Congruent?'. Economic Geography, vol. 47, no. 2 (Supplement), pp. 336-343.
- MOORE, E.G. (1966a): 'Models of Migration and the Intra-urban Case'. Australian and New Zealand Journal of Sociology, vol. 2, no. 1, pp. 16-37.
- MOORE, E.G. (1969a): 'The Structure of Intra-urban Movement Rates: An Ecological Model'. Urban Studies, vol. 6, no. 1, pp. 17-33.
- MOORE, E.G. (1969b): 'The Nature of Intra-urban Migration and Some Relevant Research Strategies'. Proceedings of the Association of American Geographers, Vol. 1, pp. 113-116.
- MOORE, E.G. (1970): 'Intra-urban Residential Mobility and Urban Spatial Structure'. In Population and Migration in an Urban Context: A Spatial Perspective (Paper No. I) Meetings of the Population Association of America.
- MOORE, E.G. (1971): 'Comments on the Use of Ecological Models in the Study of Residential Mobility in the City'. Economic Geography, vol. 47, no. 1, pp. 73-85.

- MOORE, E.G. (1972): 'Residential Mobility in the City'. Association of American Geographers, Commission on College Geography, Resource Paper No. 13.
- MORGAN, B.S. (1974): 'Social Distance and Spatial Distance: A Research Note'. Area, vol. 6, no. 4, pp. 293-297.
- MORGAN, B.S. (1975): 'The Segregation of Socio-economic Groups in Urban Areas: A Comparative Analysis'. Urban Studies, vol. 12, no. 1, pp. 47-60.
- MORIARTY, B.M. (1972): 'Locational Preferences and Urban Residential Development'. Proceedings of the Association of American Geographers, vol. 4, pp. 76-79.
- MORRILL, R.L. (1963): 'The Distribution of Migration Distances'. Papers and Proceedings of the Regional Science Association, vol. xi, pp. 75-84.
- MORRILL, R.L. (1965): 'Expansion of the Urban Fringe: A Simulation Experiment'. The Regional Science Association Papers, vol. 15, pp. 185-199.
- MULLER, J.C. (1975): 'Associations in Choropleth Map Comparison'. Annals, Association of American Geographers, vol. 65, No.3, pp. 403-413.
- MURIE, A. (1974): Household Movement and Housing Choice, Centre for Urban and Regional Studies, Birmingham University, Occasional Paper No. 28.
- MCCRACKEN, K.W.J. (1975): 'Household Awareness, Spaces and Intra-urban Migration Search Behaviour'. Professional Geographer, vol. 27, No. 2, pp. 166-170.
- NIE, N. et al (1970): Statistical Package for the Social Sciences, McGraw-Hill, New York.
- OLSON, J.M. (1975): 'Autocorrelation and Visual Map Complexity'. Annals, Association of American Geographers, vol. 65, no. 2, pp. 189-204.
- OLSSON, G. (1965): 'Distance and Human Interaction: A Migration Study'. Geografiska Annaler (Series B), vol. 47B, pp. 3-43.
- PAPAGEORGIU, G.J. (1971): 'A Theoretical Evaluation of the Existing Population Density Gradient Functions'. Economic Geography, vol. 47, no. 1, pp. 21-26.
- PARK, R.E., BURGESS, E.W. and MCKENZIE, R.D. (1925): The City, University of Chicago Press, Chicago.

- PARKES, D. (1972): 'Elements of Time and Space for an Australian Industrial City: An Urban Social Geography'. Unpublished Ph.D. thesis, University of Newcastle.
- POOLE, M.A. and O'FARRELL, P.N. (1971): 'The Assumptions of the Linear Regression Model'. Institute of British Geographers, Transaction No. 52, pp. 145-158.
- RAVENSTEIN, E.G. (1885): 'The Laws of Migration'. Journal of the Royal Statistical Society, vol. 48, pp. 167-235.
- REES, P.H. (1970): 'Concept of Social Space: Toward an Urban Social Geography'. In Geographic Perspectives on Urban Systems with Integrated Readings, edited by B.J.L. Berry and F.E. Horton, Chapter 10. Prentice-Hall, New Jersey.
- REES, P.H. (1971): 'Factorial Ecology: An Extended Definition, Survey and Critique of the Field'. Economic Geography, vol. 47, no. 2 (Supplement), pp. 220-233.
- ROBSON, B.T. (1969): Urban Analysis. A Study of City Structure with Special Reference to Sunderland, Cambridge University Press, London.
- ROBSON, B.T. (1975): 'The Urban Environment'. Geography, vol. 60, no. 268, pp. 184-188.
- ROSE, H.M. (1970): 'The Development of an Urban Subsystem: The Case of the Negro Ghetto'. Annals, Association of American Geographers, vol. 60, no. 1, pp.1-17.
- ROSEMAN, C.C. (1971): 'Migration as a Spatial and Temporal Process'. Annals, Association of American Geographers, vol. 61, No.3, pp. 589-598.
- ROSEMAN, C.C. (1973): 'Comment in Reply'. Annals, Association of American Geographers, vol. 63, no. 1, pp. 155-156.
- ROSS, H.L. (1962): 'Reasons for Moves to and from a Central City Area'. Social Forces, vol. 40, pp. 261-263.
- ROSSI, P.H. (1955): 'Why Families Move'. In The Language of Social Research. A Reader in the Methodology of Social Research, edited by P.F. Lazarsfeld and M. Rosenberg, Free Press, Glencoe, Illinois, pp. 457-468.
- SABINO, A.J. (1973): 'Residential Mobility' Unpublished thesis for Dip. Techn. Town Planning (S.A.I.T.), Adelaide.
- SALINS, P.D. (1971): 'Household Patterns in American Metropolitan Areas'. Economic Geography, vol. 47, no. 2 (Supplement) pp. 234-248.

- SANDERS, R.A. (1975): 'The 1970 Public Use Sample: A Geographical Context'. The Professional Geographer, vol. xxvii, no. 3, pp. 347-349.
- SCHWIND, P.J. (1975): 'A General Field Theory of Migration: United States, 1955-1960'. Economic Geography, vol. 51, no. 1, pp. 1-16,
- SHEVKY, E. and BELL, W. (1955): Social Area Analysis: Theory, Illustrative Application and Computational Procedures, Stanford University Press, Stanford.
- SIEGEL, S. (1956): Nonparametric Statistics for the Behavioural Sciences, McGraw-Hill, New York.
- SIMMONS, J.W. (1968): 'Changing Residence in the City; A Review of Intra-urban Mobility'. Geography Review, vol. 58, no. 4, pp. 622-651.
- SINCLAIR, D. (1975): 'A Causal Analysis of Population Turnover Rates'. Geography Bulletin, vol. 7, no. 1, pp. 4-13.
- STIMSON, R.J. (1971): 'Social Differentiation in Residential Areas in Adelaide'. 43rd Anzaas Congress, Section 21, Brisbane.
- STIMSON, R.J. (1972): 'Perceived Status and Residential Desirability of Adelaide Suburbs'. 44th Anzaas Congress, Section 21, Sydney.
- STIMSON, R.J. (1974): 'The Social Structure of Large Cities'. In Urbanization in Australia, edited by I.H. Burnley, Cambridge University Press, pp. 147-164.
- STIMSON, R.J. and CLELAND, E.A. (1975): A Socio-Economic Atlas of Adelaide. An Analysis of the 1971 Census, School of Social Sciences, The Flinders University of S.A. and the Department for Community Welfare, South Australia.
- STOUFFER, S.A. (1940): 'Intervening Opportunities: A Theory Relating Mobility and Distance'. American Sociological Review, vol. 5, pp. 845-867.
- STRETTON, H. (1970): Ideas for Australian Cities. By the author, Griffin Press, Adelaide.
- TIMMS, D.W.G. (1967): 'Occupational Stratification and Friendship Nomination: A Study in Brisbane'. Australian and New Zealand Journal of Sociology, vol. 3, no. 1, pp. 32-43.
- TIMMS, D.W.G. (1971): The Urban Mosaic. Towards a Theory of Residential Differentiation, Cambridge University Press, Cambridge.

- WALBERG, H.J. and BARGEN, M. (1974): 'Urban Spatial Models'. In Evaluating Educational Performance. A Source Book of Methods, Instruments and Examples. Chapter 19, McCutchan Publishing Corporation, Berkeley, California.
- WARNES, A.M. (1975): 'Commuting Towards City Centres: A Study of Population and Employment Gradients in Liverpool and Manchester'. Institute of British Geographers, Transactions No. 64, pp. 77-96.
- WHEELER, J.O. (1968): 'Residential Location by Occupational Status'. Urban Studies, vol. 5, no. 1, pp. 24-32.
- WHITELAW, J.S. (1971): 'Migration Patterns and Residential Selection in Auckland, New Zealand'. Australian Geographical Studies, vol. 9, no. 1, pp. 61-76.
- WHITELAW, J.S. (1972): 'Scale and Urban Migrant Behaviour'. Australian Geographical Studies, vol. 10, no. 1, pp. 101-106.
- WHITELAW, J.S. (1973): 'Intra-urban Migration'. Geographical Education, vol. 2, no. 1, pp. 75-87.
- WHITELAW, J.S. and GREGSON, J.S. (1972): 'Search Procedures in the Intra-urban Migration Process'. Monash Publications in Geography, No. 2.
- WOLPERT, J. (1965): 'Behavioural Aspects of the Decision to Migrate'. Papers of the Regional Science Association, vol. 15, pp. 159-169.
- WOLPERT, J. (1966): 'Migration as an Adjustment to Environmental Stress'. Journal of Social Issues, vol. 22, no. 4, pp. 92-102.
- YAPA, L., POLESE, M. and WOLPERT, J. (1971): 'Independencies of Commuting, Migration, and Job Site Relocation'. Economic Geography, vol. 47, no. 1, pp. 59-72.
- YEATES, M. (1974): An Introduction to Quantitative Analysis in Human Geography, McGraw-Hill, New York.

APPENDIX A

Maps showing the distribution among the fifty electoral subdivisions within the Adelaide Statistical Division of 28 selected indices of population, housing and geometric measures.

Sources are shown on the individual maps.

Appendix A

The diagrams listed below appear in the same order on the following pages.

- FIG. A.1. Key to names and computer code numbers of electoral subdivisions (S.D.s) within the Adelaide Statistical Division (A.S.D.), March 1970.
- FIG. A.2. Index X_1 Index of age differential.
- FIG. A.3. Index X_2 Mean age of total population.
- FIG. A.4. Index X_3 Mean age of adult population.
- FIG. A.5. Index X_4 Child/woman ratio.
- FIG. A.6. Index X_5 Percentage of population dependent children between 0 and 15 years of age.
- FIG. A.7. Index X_6 Age structure index (Regression Coefficient after Coulson, 1968).
- FIG. A.8. Index X_7 Percentage Australian born in the total population.
- FIG. A.9. Index X_8 Population density in persons per square kilometre.
- FIG. A.10. Index X_9 Percentage of 1971 population in same dwelling in 1971 as 1966.
- FIG. A.11. Index X_{10} Percentage adult population with tertiary qualifications.
- FIG. A.12. Index X_{11} Percentage of single females.
- FIG. A.13. Index X_{12} Percentage of single males.
- FIG. A.14. Index X_{13} Males who are employers or self-employed.
- FIG. A.15. Index X_{14} Percentage of labour force who are employers or self-employed.
- FIG. A.16. Index X_{15} Percentage of male labour force who are employers or self-employed.
- FIG. A.17. Index X_{16} Percentage of workforce in professional or administrative occupations.

- FIG. A.18. Index X_{17} Private homes,
- FIG. A.19 Index X_{18} Separate private homes.
- FIG. A.20 Index X_{19} Percentage of dwellings owner-occupied.
- FIG. A.21. Index X_{20} Percentage of dwellings occupied by tenants of S.H.A.
- FIG. A.22. Index X_{21} Percentage of dwellings unoccupied.
- FIG. A.23. Index X_{22} Distance (km) from C.B.D.
- FIG. A.24. Index X_{23} Distance (km) from P.C.G.
- FIG. A.25. Index X_{24} Area of subdivision (sq. km.),
- FIG. A.26. Index PT Percentage annual population turnover of electors, 1970-71.
- FIG. A.27. Index NM Percentage annual net migration of electors 1970-71.
- FIG. A.28. Index ER Total persons on electoral rolls, 11 June, 1971.
- FIG. A.29. Index BN British nationals, 21 years and over.
- FIG. A.30. Total population (persons).
- FIG. A.31. Percentage of British Nationals in adult population.
- FIG. A.32. Percentage of adult aliens in total population.
- FIG. A.33. Percentage of population in usual dwelling.
- FIG. A.34. Percentage of all dwellings temporarily unoccupied.

Code No.	Subdivision	Code No.	Subdivision
71	ADELAIDE	78	HINDMARSH
711	Adelaide	781	Beverley
712	Florey West	782	Hanson North
713	Gilles West	783	Henley Beach
714	Ross Smith	784	Peake
715	St. Peters	785	Spence South
716	Torrens	786	Thebarton
72	ANGAS [part]	79	KINGSTON
722	Fisher East	791	Brighton
724	Heysen North [part] ¹	792	Glenelg
		793	Hanson South
		794	Mawson
73	BARKER [part]	80	PORT ADELAIDE
730	Alexandra [part] ²	801	Albert Park
731	Fisher South	802	Angle Park
732	Flagstaff Hill	803	Price
736	Moana	804	Semaphore
		805	Spence North
74	BONYTHON	81	STURT
741	Elizabeth	811	Coles
742	Florey East	812	Davenport
743	Modbury North	813	Gilles East
744	Playford	814	Highbury
745	Salisbury		
75	BOOTHBY	82	WAKEFIELD [part]
751	Bragg	823	Goyder [part] ³
752	Fisher North	824	Light North [part] ⁴
753	Leabrook		
754	Mitcham		
755	Norwood		
756	Unley		
77	HAWKER		
771	Ascot Park		
772	Fisher West		
773	Goodwood		
774	Hanson East		
775	Marleston		
776	Mitchell		

KEY TO CODE NUMBERS, NAMES AND LOCATION
OF ELECTORAL SUBDIVISIONS

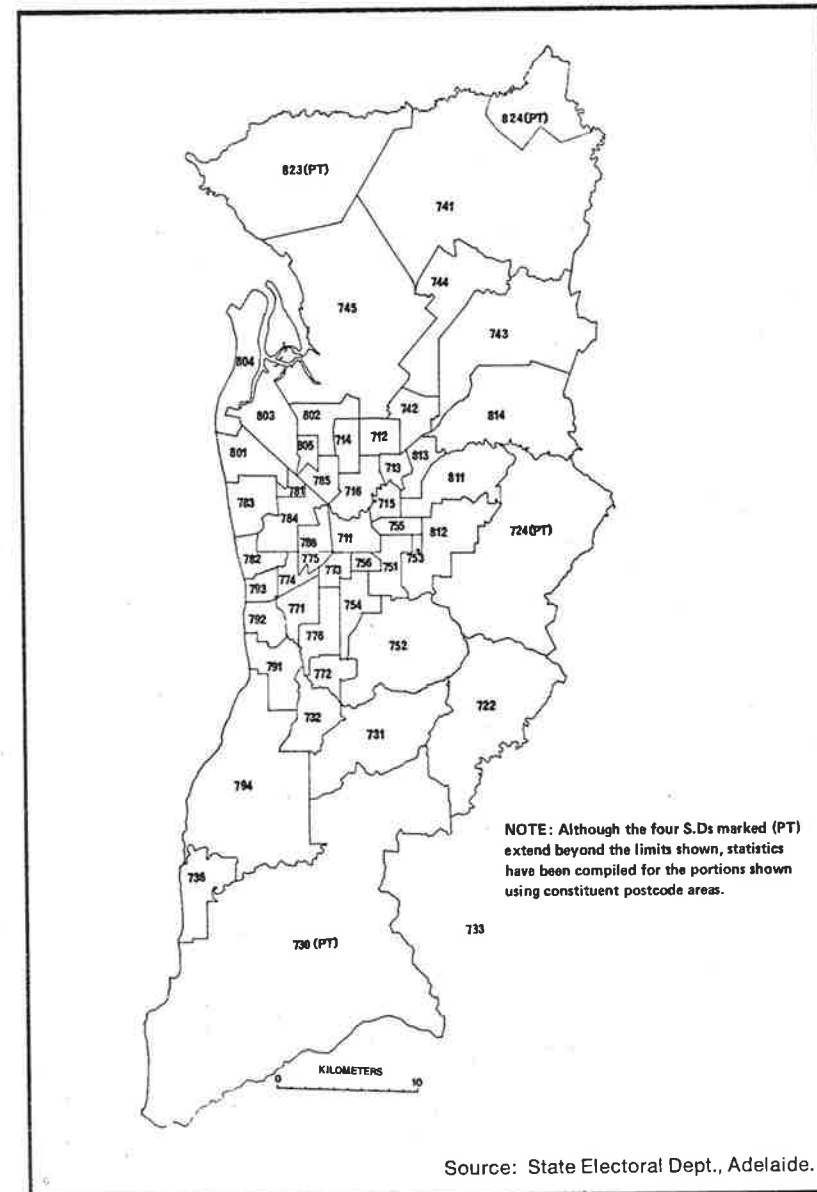
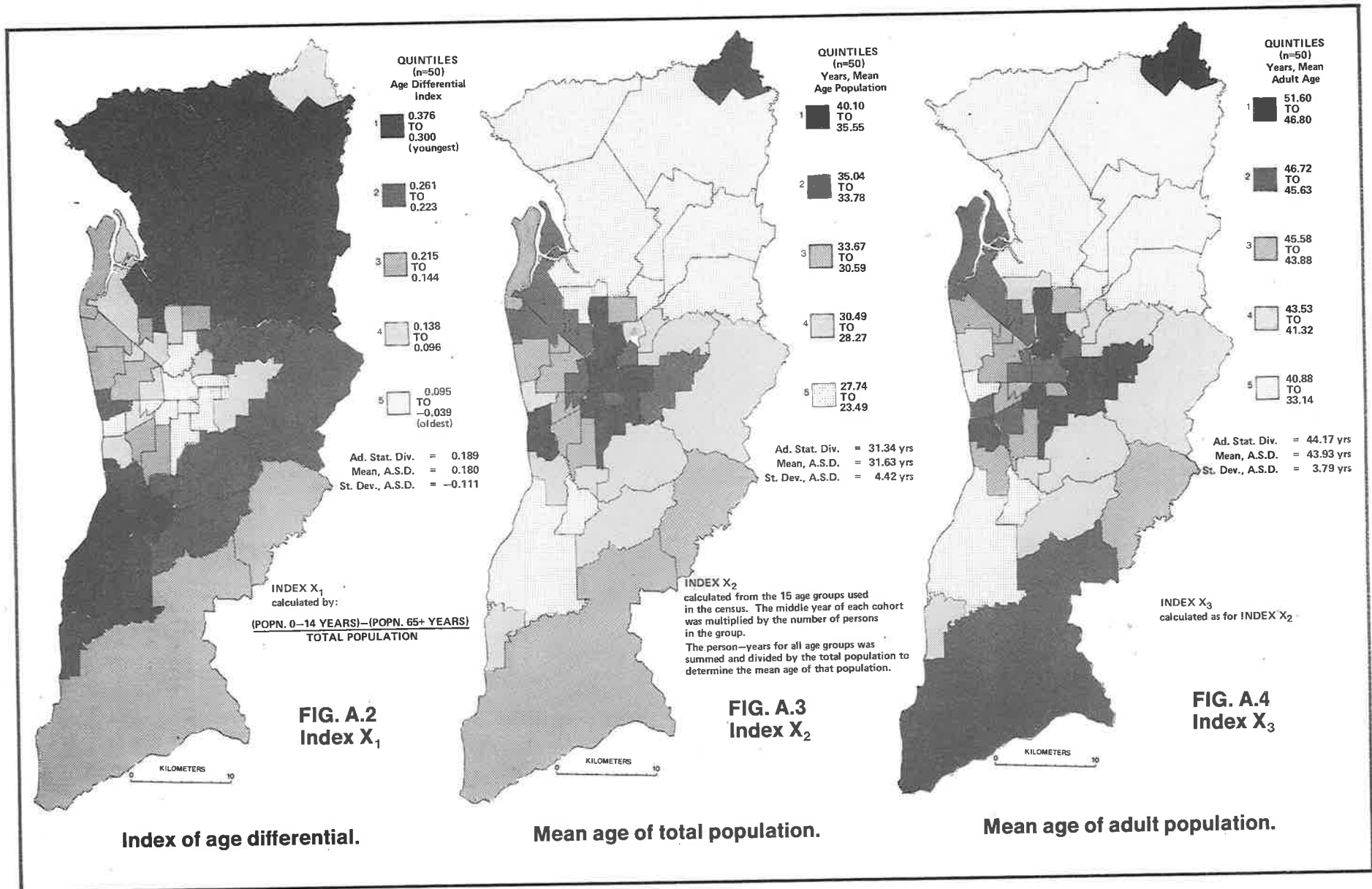
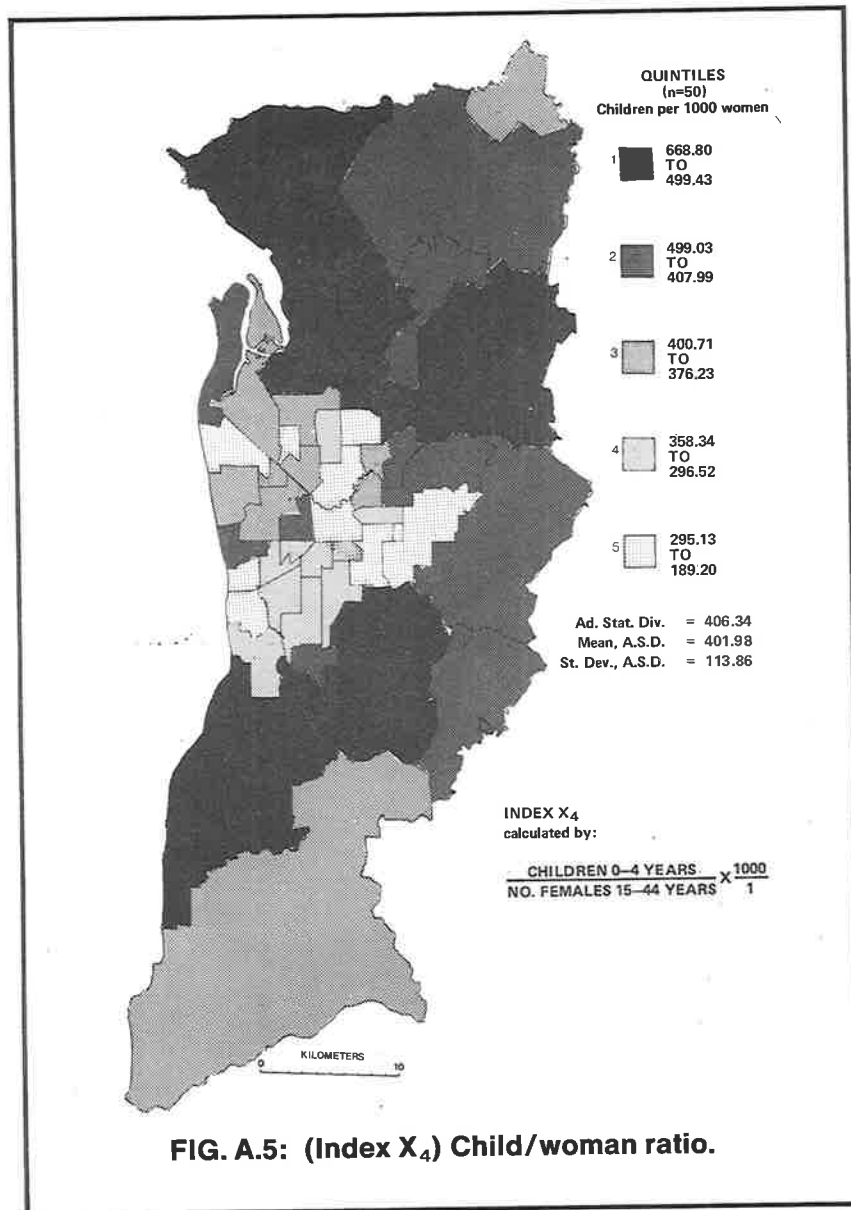

FIG. A.1: Key to names and computer code numbers of electoral subdivisions (S.D.s) within the Adelaide Statistical Division (A.S.D.) March, 1970.



Source: Calculations based on data from A.B.S. Census, June 1971.



Source: Calculations based on data from A.B.S. Census, June 1971.

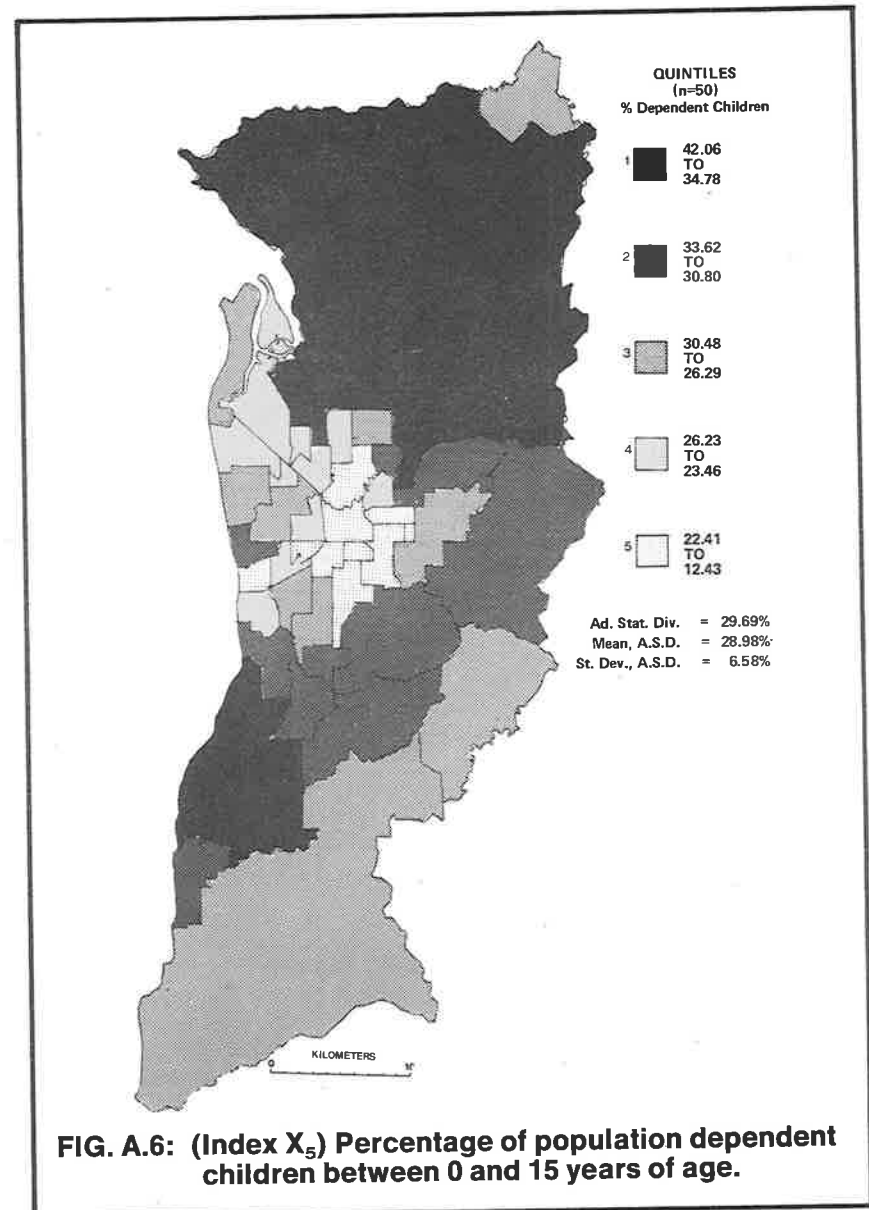

Source: Calculations based on data from A.B.S. Census, June 1971.

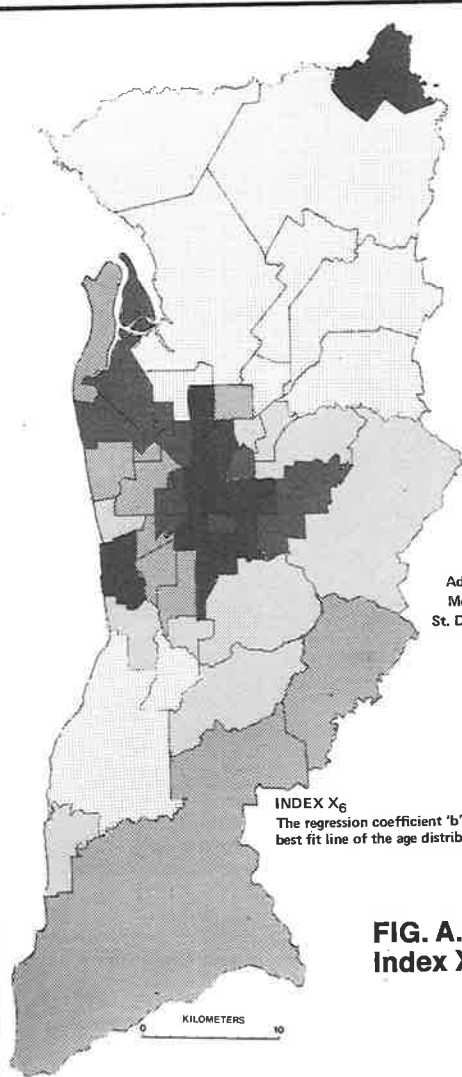

QUINTILES (n=50)
Age Regression Coefficient 'b'

1	0.044 TO -0.021 (oldest)
2	-0.028 TO -0.046
3	-0.047 TO -0.092
4	-0.093 TO -0.125
5	-0.132 TO -0.193 (youngest)

Ad. Stat. Div. = -0.081
Mean, A.S.D. = -0.077
St. Dev., A.S.D. = 0.063

INDEX X₆
The regression coefficient 'b' is the slope of the best fit line of the age distribution pyramid.

FIG. A.7
Index X₆

Age structure index (Regression Coefficient, after Coulson, 1968).

Source: Calculations based on data from A.B.S. Census, June 1971.

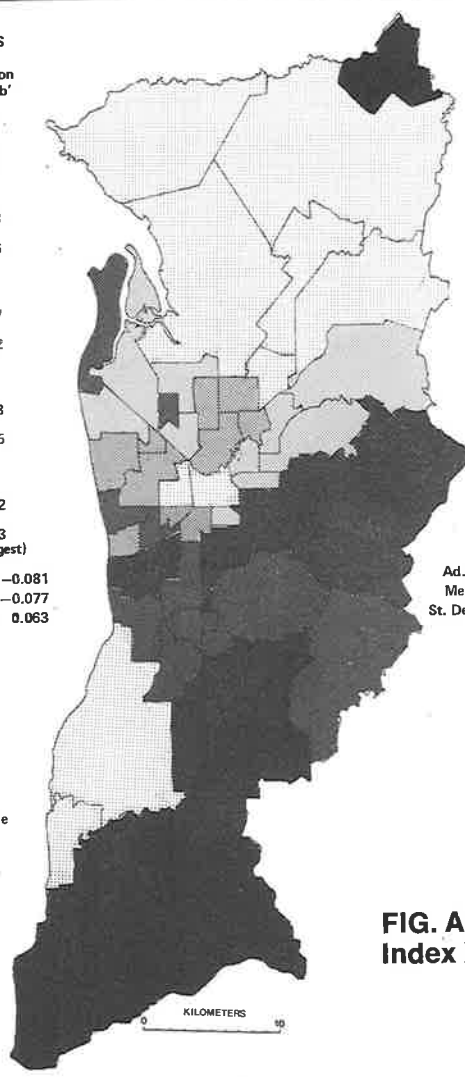

QUINTILES (n=50)
% Australian Born

1	89.09 TO 81.86
2	81.49 TO 78.00
3	77.73 TO 72.88
4	72.41 TO 68.33
5	67.85 TO 44.17

Ad. Stat. Div. = 71.92%
Mean, A.S.D. = 73.42%
St. Dev., A.S.D. = 9.84%

FIG. A.8
Index X₇

Percentage Australian born in the total population.

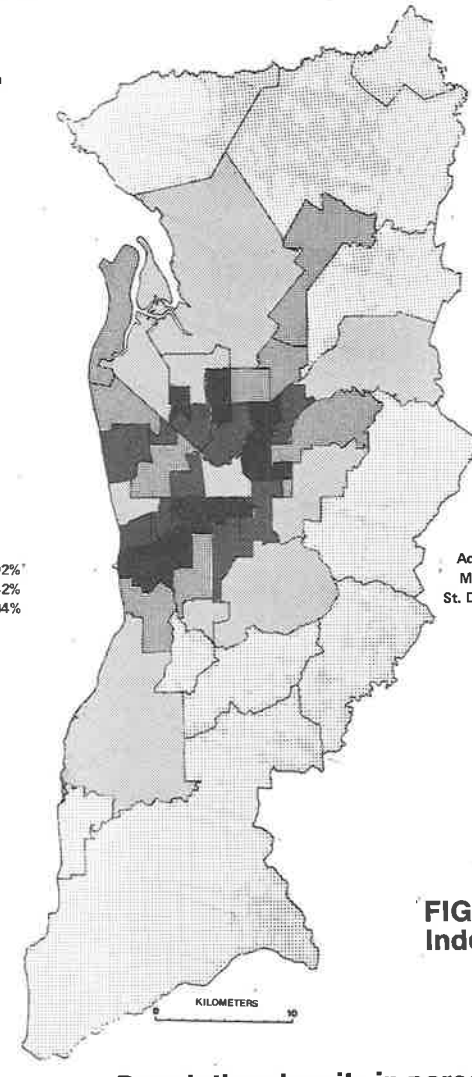

QUINTILES (n=50)
Persons per Square Km.

1	3,366.67 TO 2,360.12
2	2,344.31 TO 2,021.67
3	1,967.58 TO 895.24
4	853.61 TO 228.77
5	212.07 TO 12.27

Ad. Stat. Div. = 1,463.45
Mean, A.S.D. = 1,403.48
St. Dev., A.S.D. = 999.67

FIG. A.9
Index X₈

Population density in persons per square kilometre.

Source: A.B.S. Census, June 1971, population. Areas derived from planimeter measures on large scale maps and independent calculations based upon co-ordinate references.

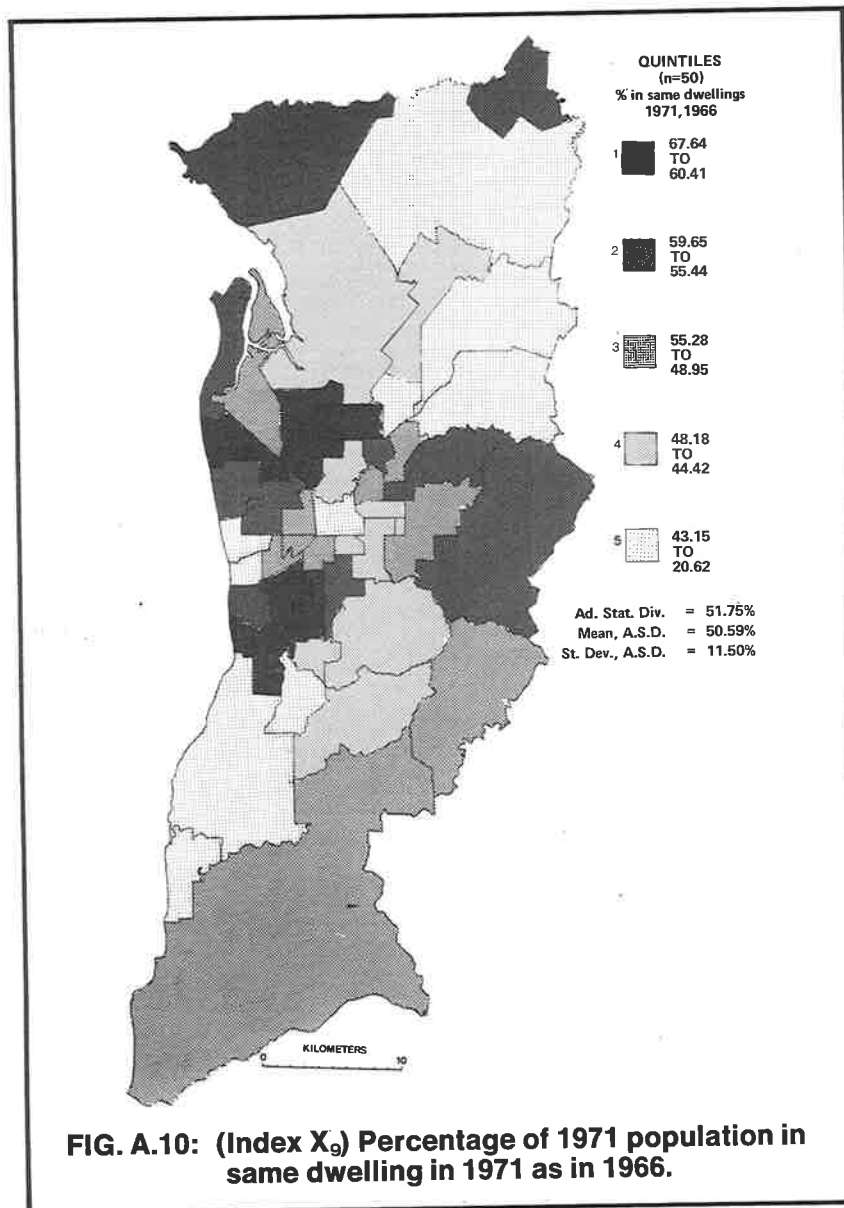

Source: A.B.S. Census, June 1971.

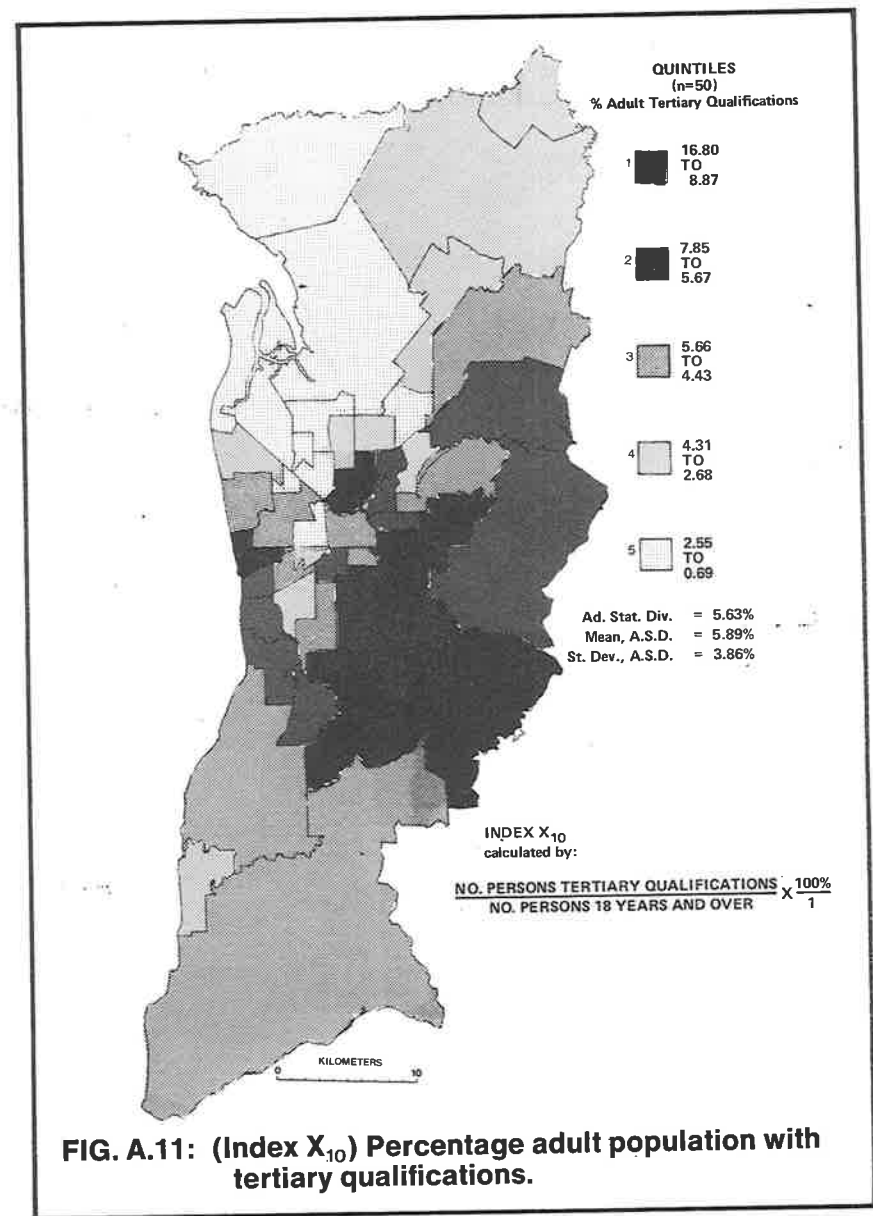

Source: Calculations based on data from A.B.S. Census, June 1971.

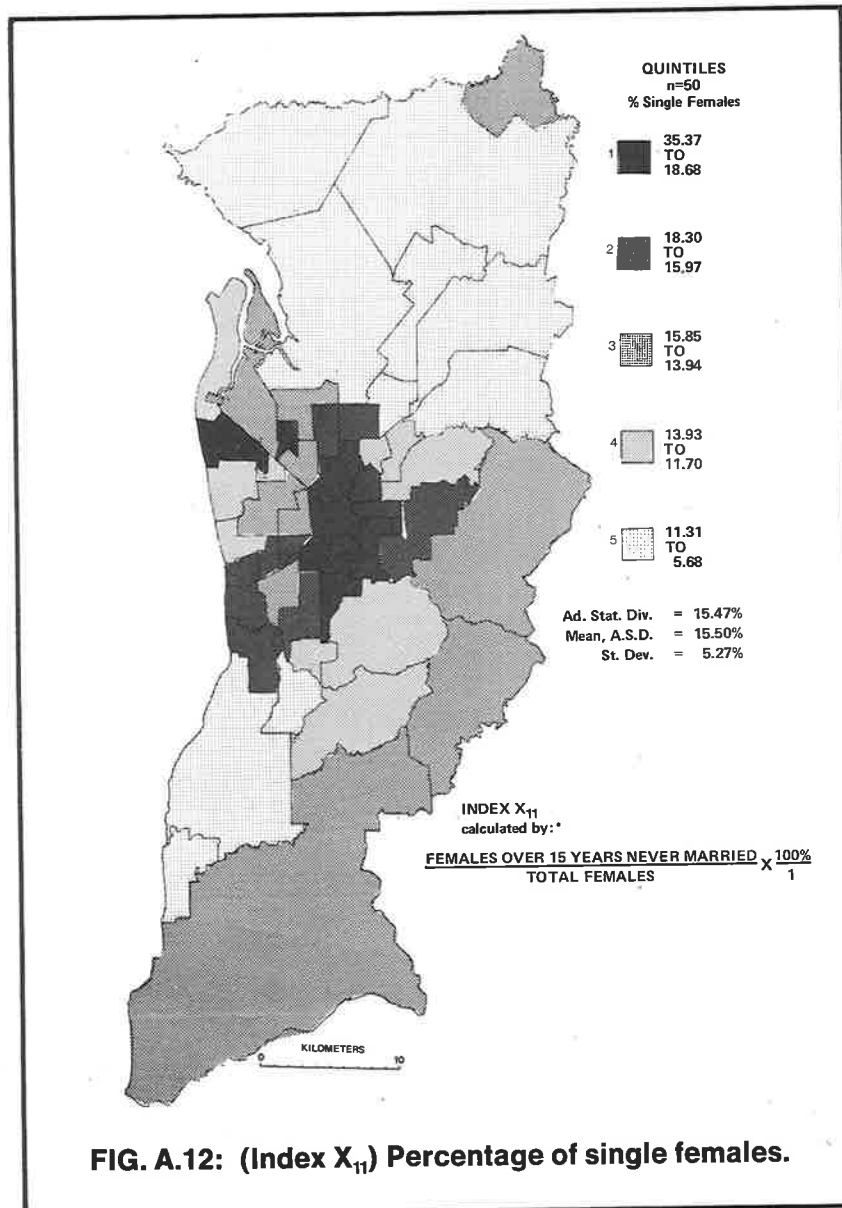

FIG. A.12: (Index X₁₁) Percentage of single females.

Source: Calculations based on data from A.B.S. Census, June 1971.

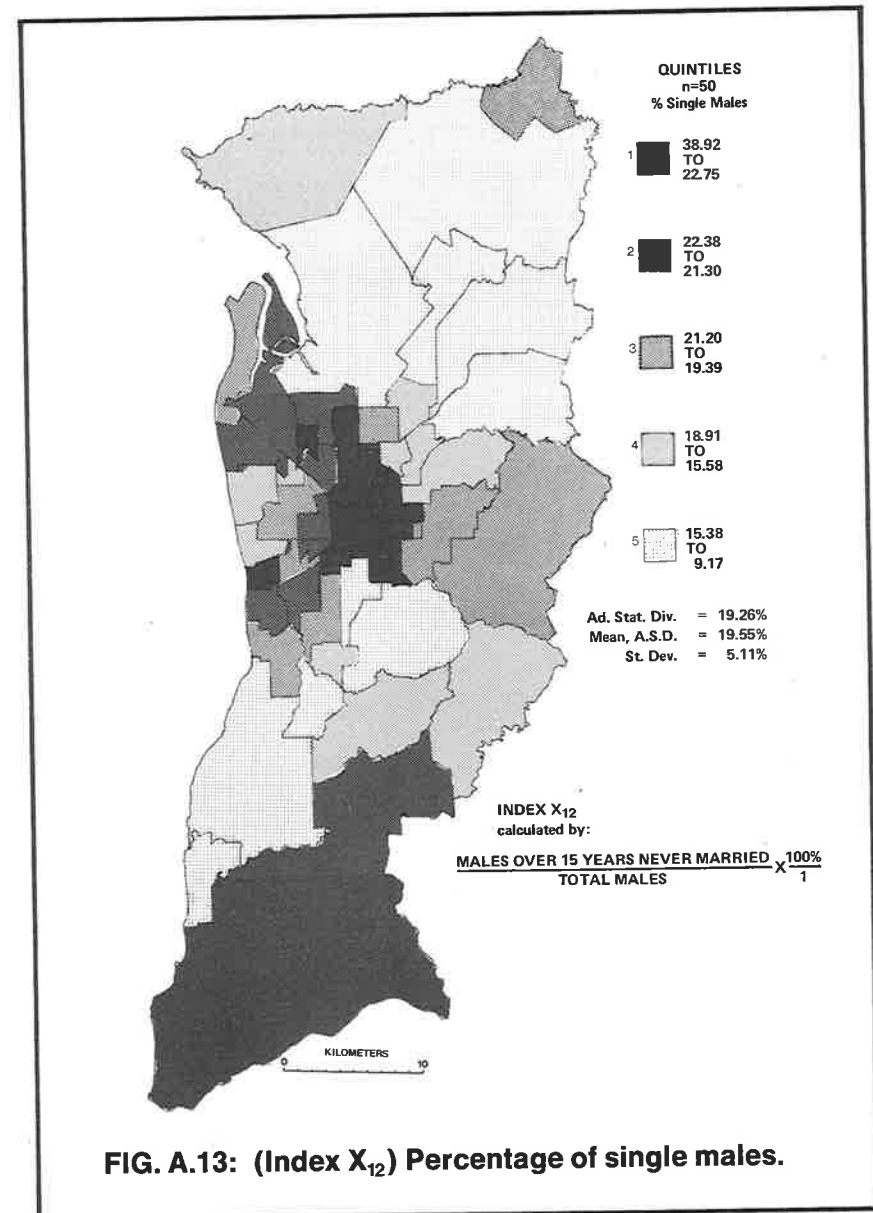
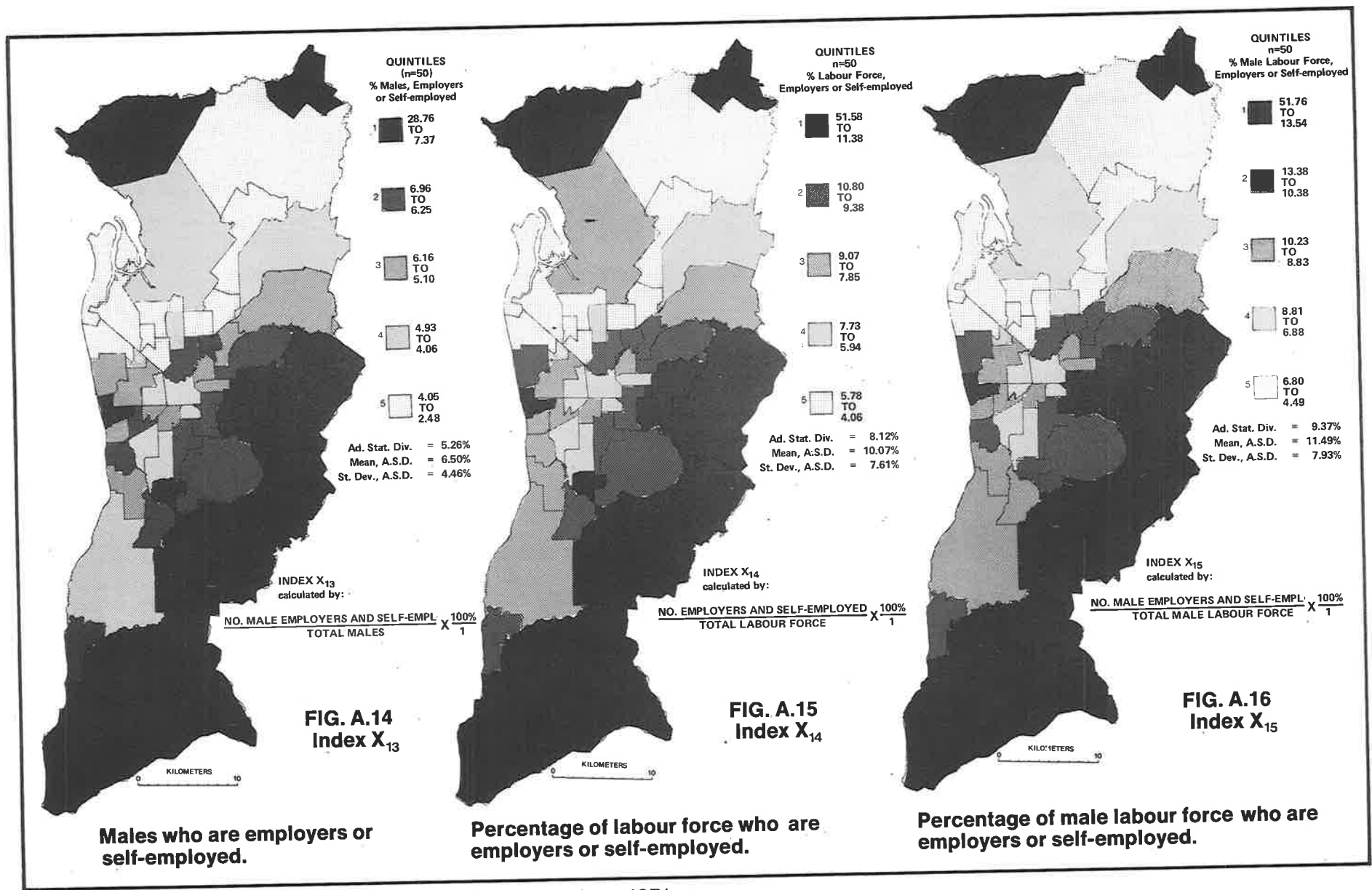
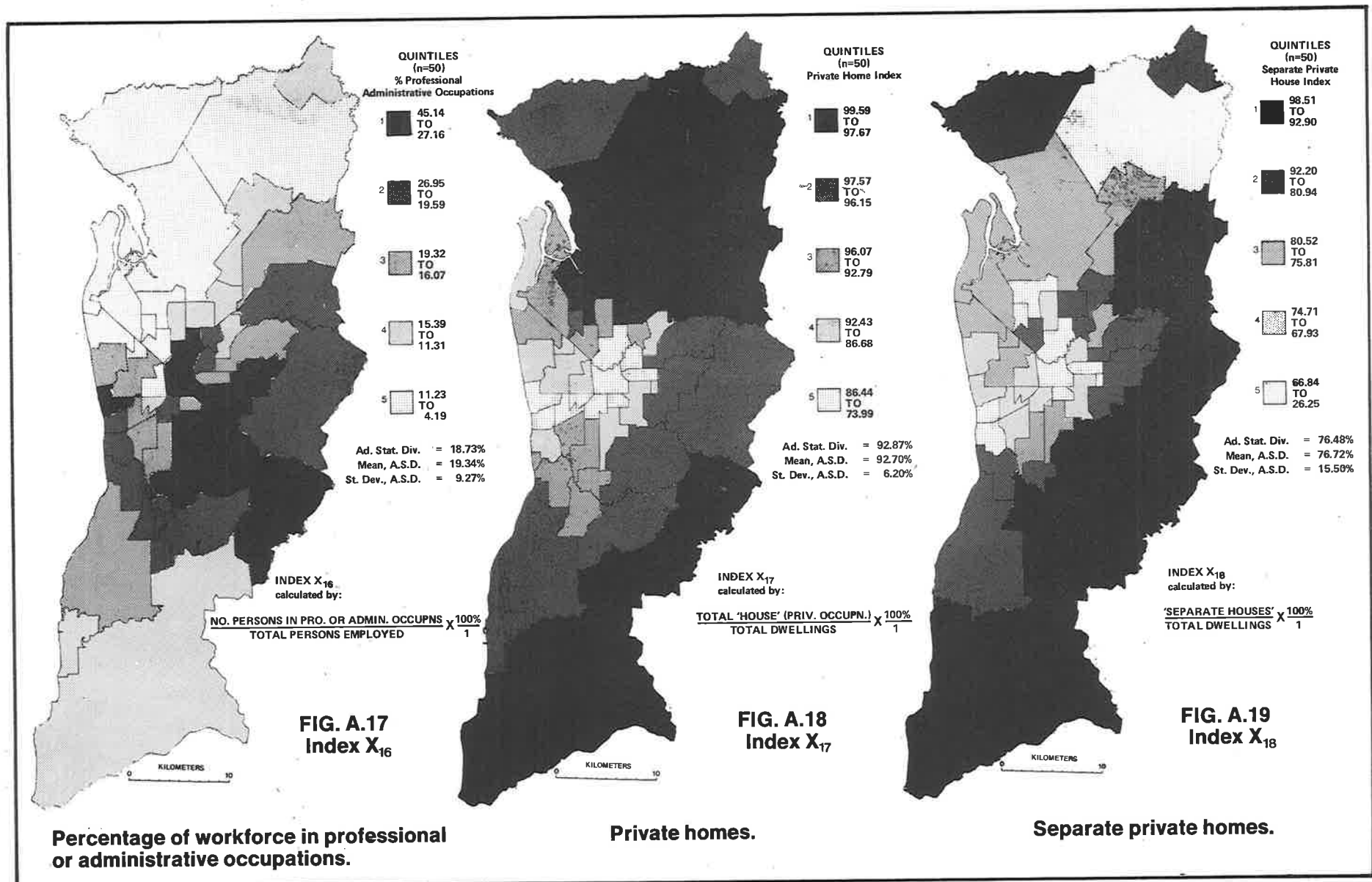

FIG. A.13: (Index X₁₂) Percentage of single males.

Source: Calculations based on data from A.B.S. Census, June 1971.



Source: Calculations based on data from A.B.S. Census, June 1971.



Source: Calculations based on data from A.B.S. Census, June 1971.

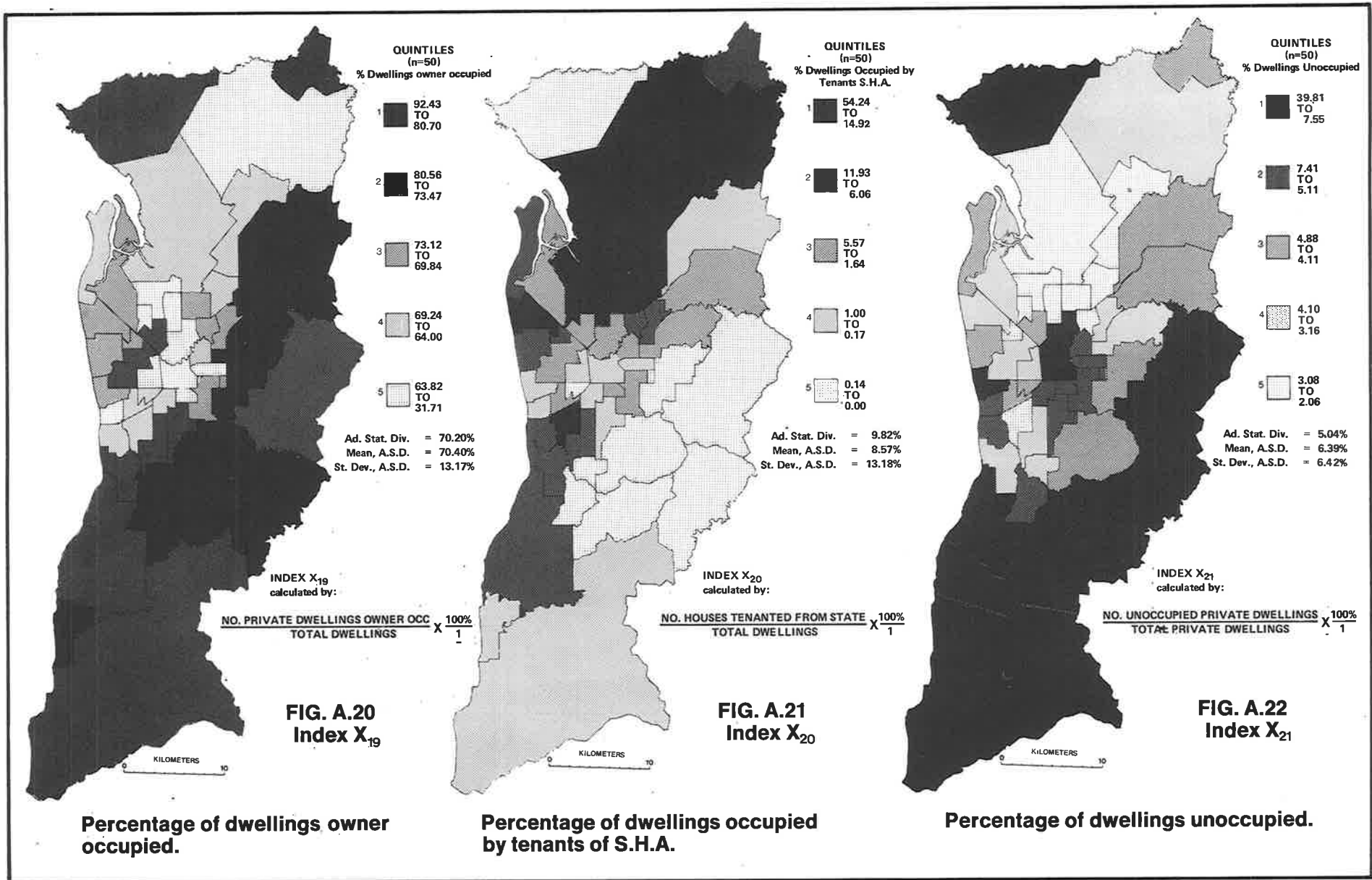

Source: Calculations based on data from A.B.S. Census, June 1971.

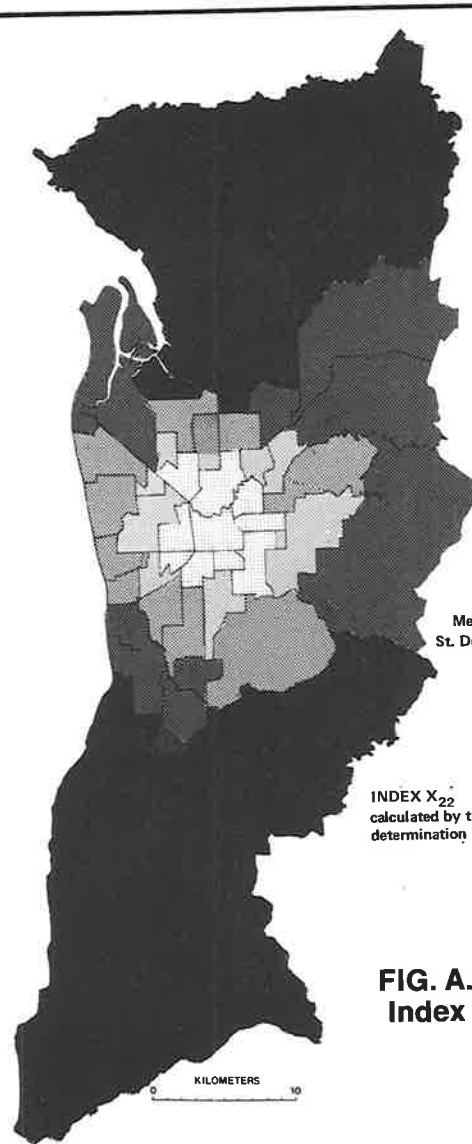

QUINTILES (n=50)
Distance from C.B.D.

1	37.10 TO 15.80
2	15.10 TO 9.60
3	8.90 TO 7.20
4	7.10 TO 4.70
5	4.50 TO 0.50

Mean, A.S.D. = 10.65km
St. Dev., A.S.D. = 8.07km

INDEX X₂₂
calculated by the 'CENTROIDS' determination programme.

FIG. A.23
Index X₂₂

Distance (km) from C.B.D.
Source: The U.B.D. map of Adelaide, City and Suburbs.

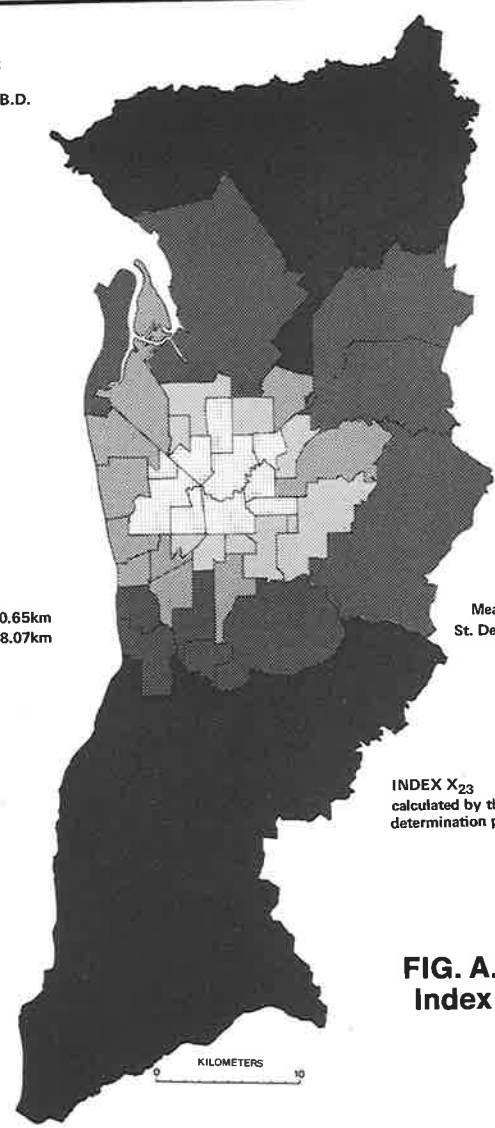

QUINTILES (n=50)
Distance from P.C.G.

1	35.30 TO 16.20
2	14.00 TO 9.90
3	9.80 TO 6.90
4	6.70 TO 5.00
5	4.60 TO 1.30

Mean, A.S.D. = 10.79km
St. Dev., A.S.D. = 8.08km

INDEX X₂₃
calculated by the 'CENTROIDS' determination programme.

FIG. A.24
Index X₂₃

Distance (km) from P.C.G.

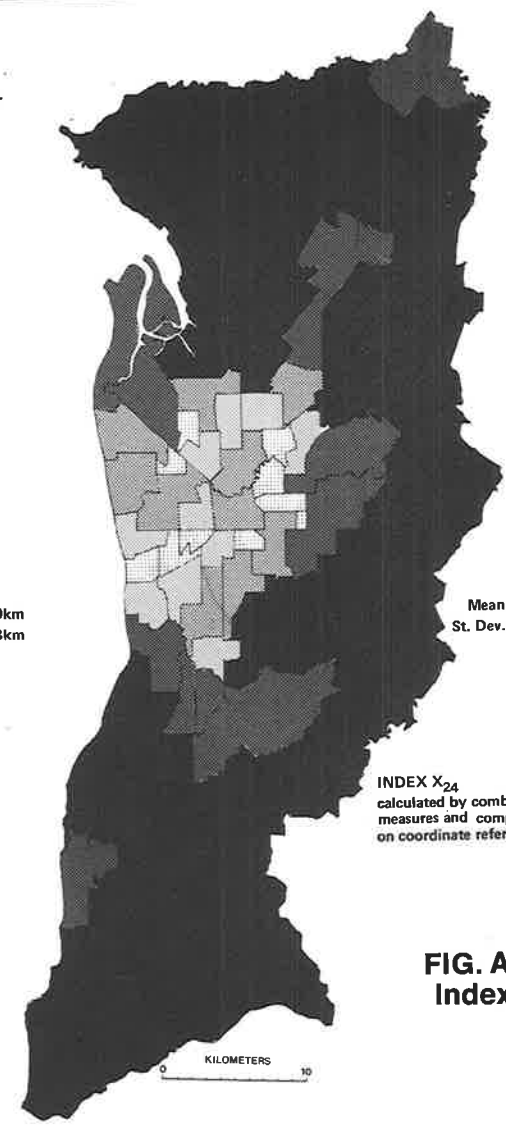

QUINTILES (n=50)
Area of Subdivision

1	351.66 TO 58.06
2	53.59 TO 16.76
3	15.20 TO 10.39
4	10.23 TO 5.65
5	5.60 TO 1.04

Mean, A.S.D. = 36.35 sq. km.
St. Dev., A.S.D. = 59.84 sq. km.

INDEX X₂₄
calculated by combination of planimeter measures and computer calculations based on coordinate references.

FIG. A.25
Index X₂₄

Area of subdivision (sq. km).
Source: Author's calculation (see above means).

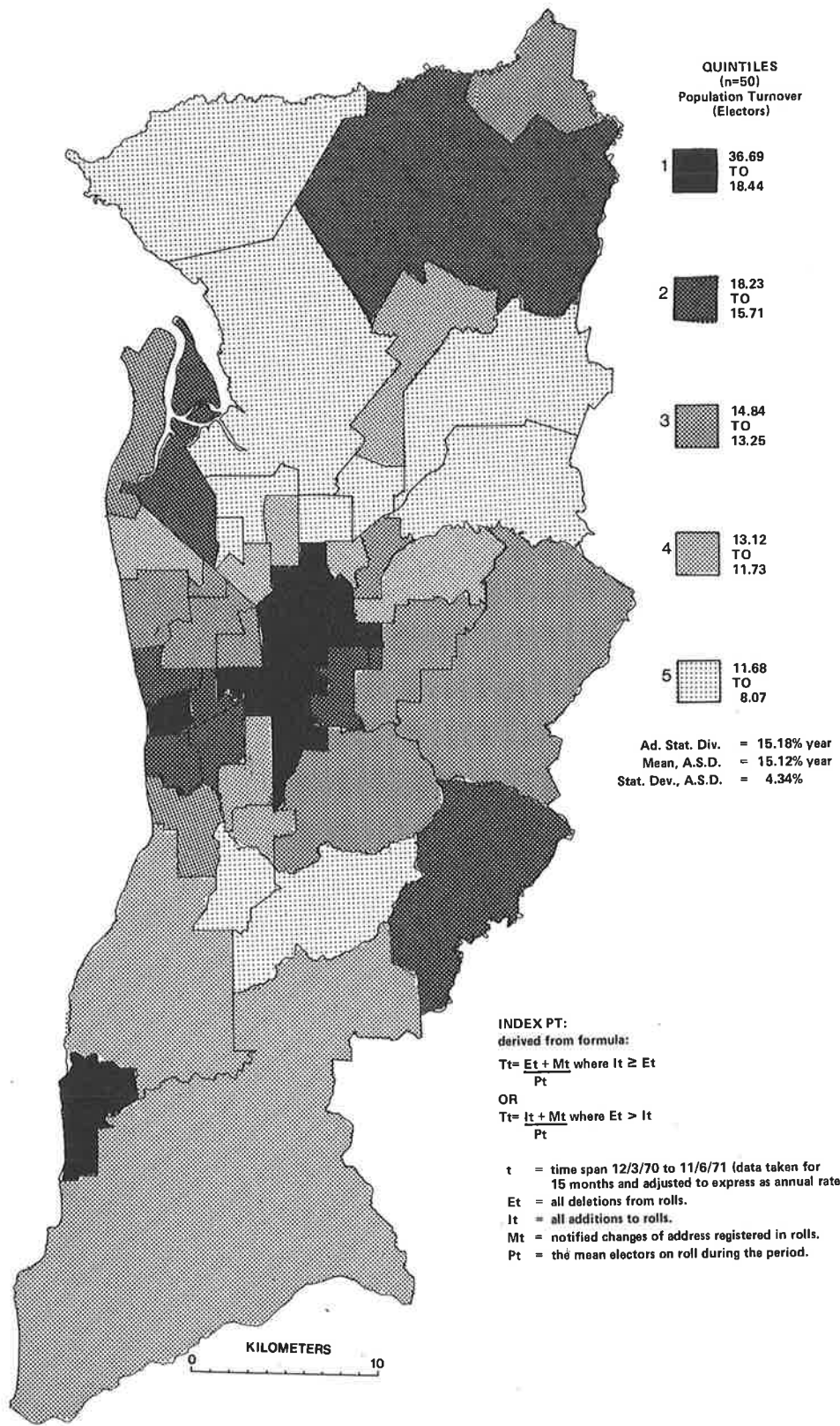

FIG. A.26: (Index PT) Percentage annual population turnover of electors, 1970-71.

Source: Data supplied by State Electoral Dept., Adelaide.

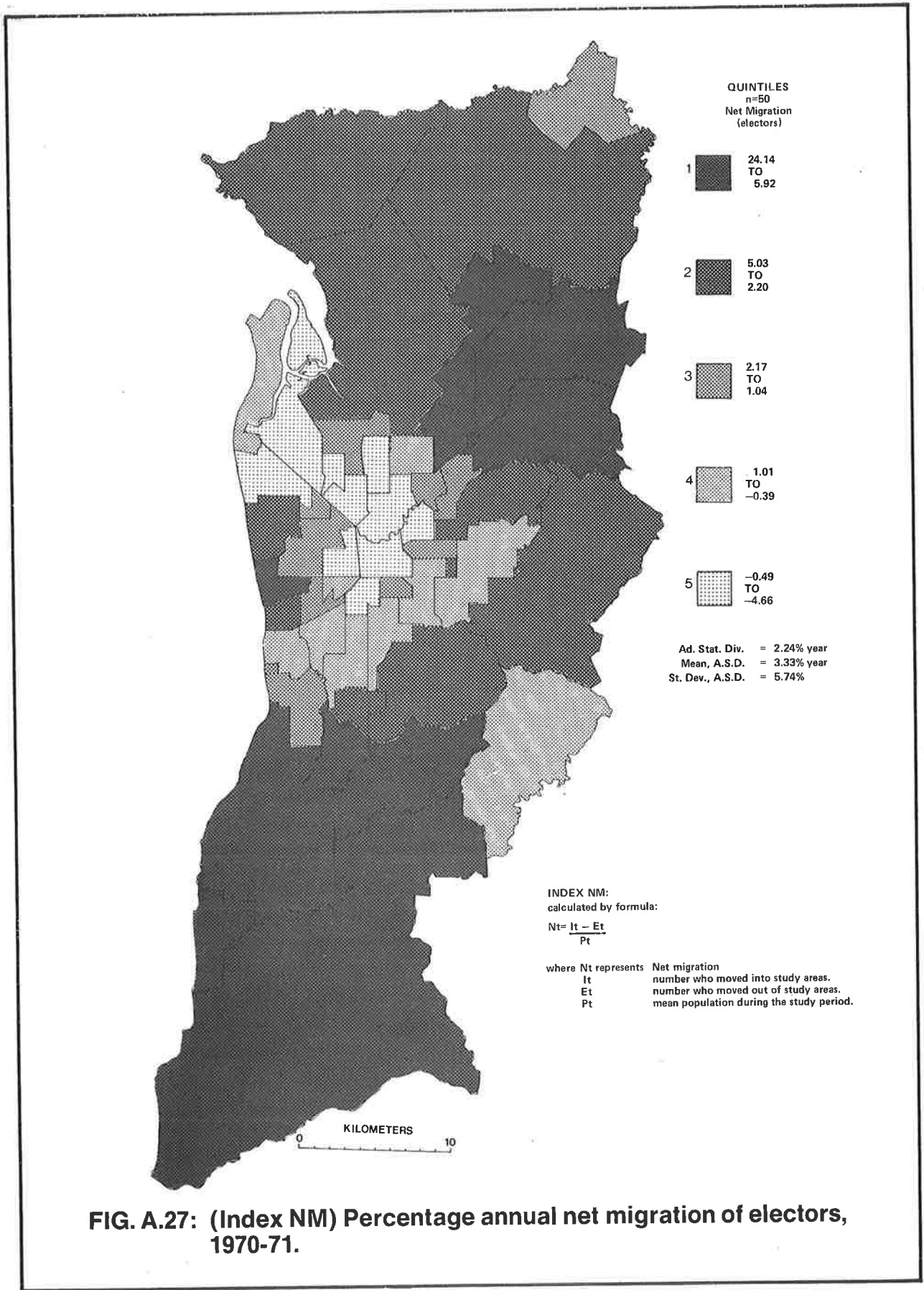
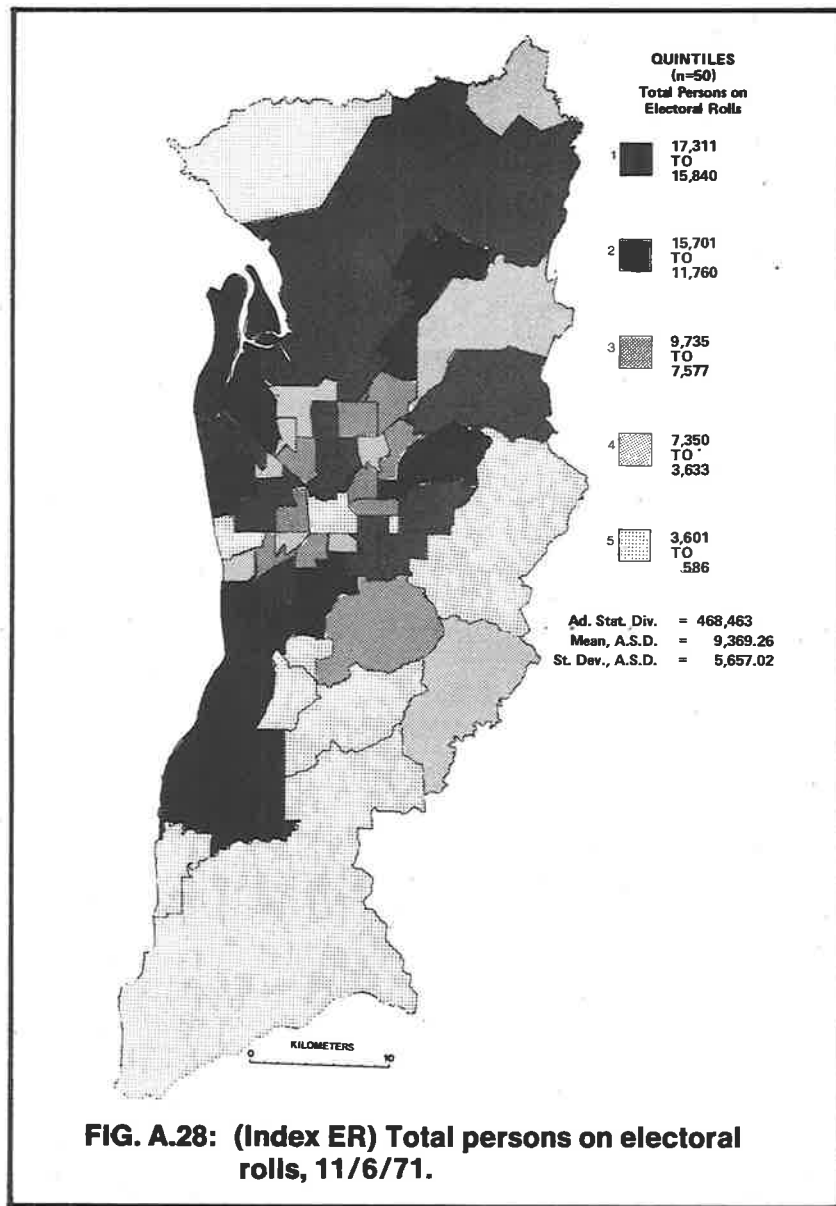
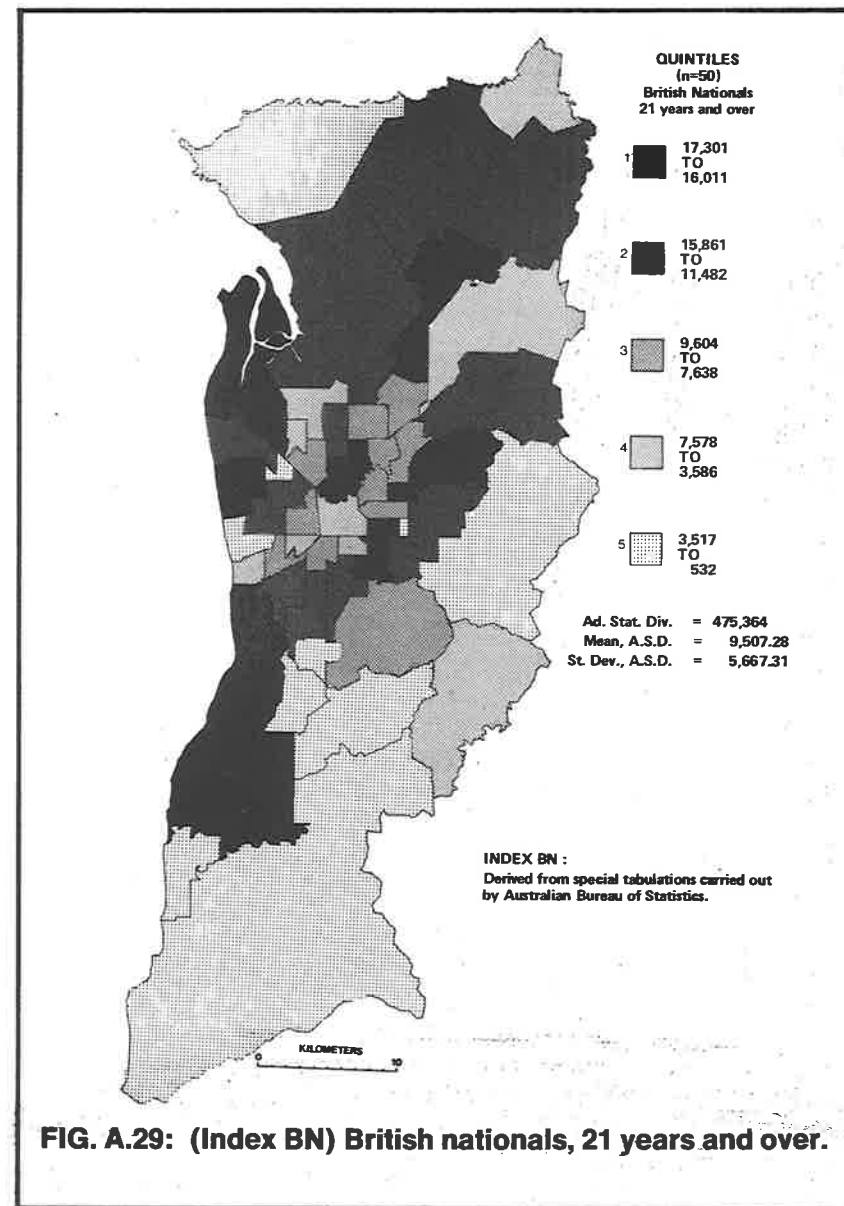

FIG. A.27: (Index NM) Percentage annual net migration of electors, 1970-71.

Source: Data supplied by State Electoral Dept., Adelaide.



Source: Data supplied by State Electoral Dept., Adelaide.



Source: A.B.S. Census, June 1971.

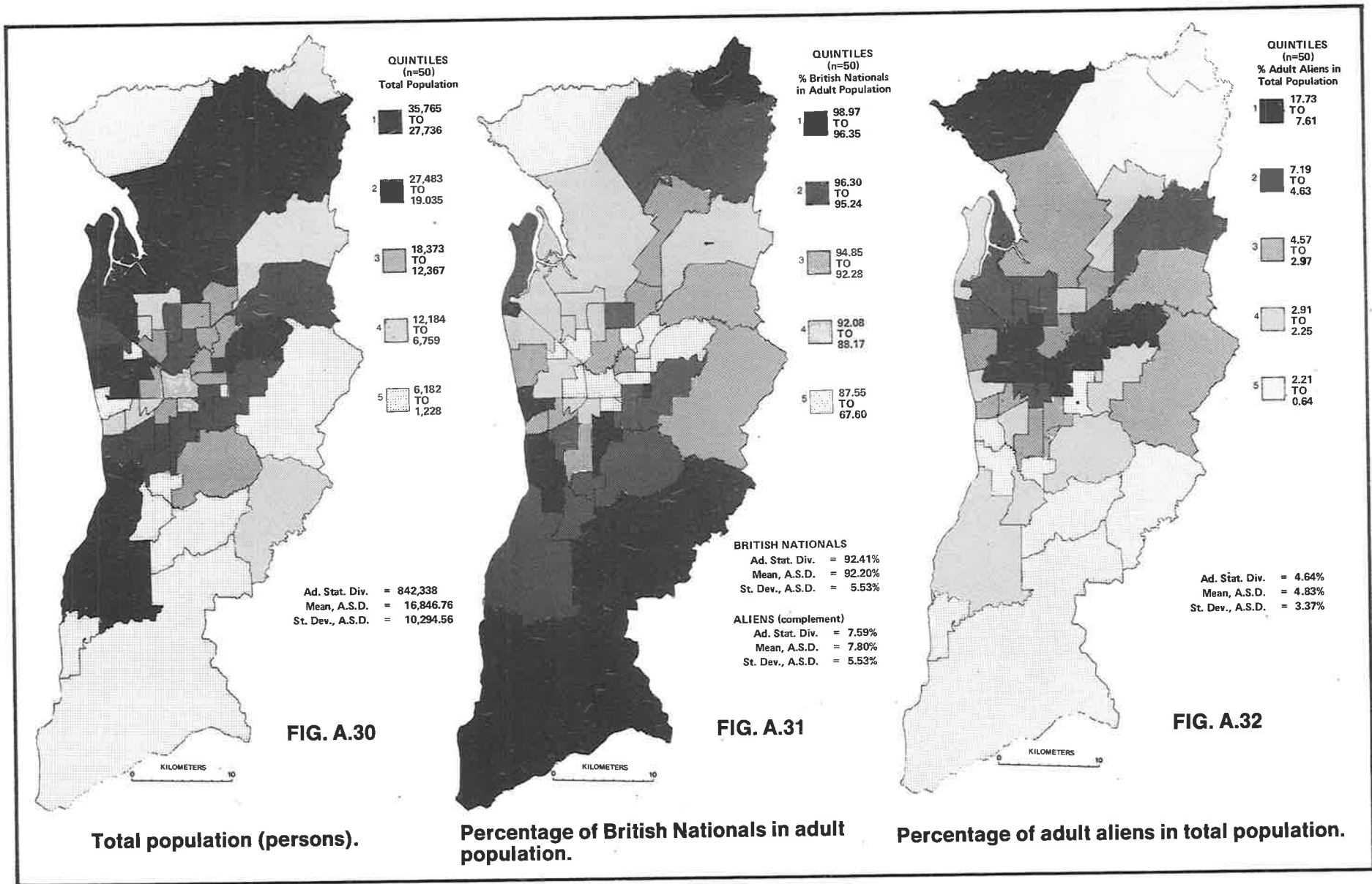

Total population (persons).

Percentage of British Nationals in adult population.

Percentage of adult aliens in total population.

Source: A.B.S. Census, June 1971.

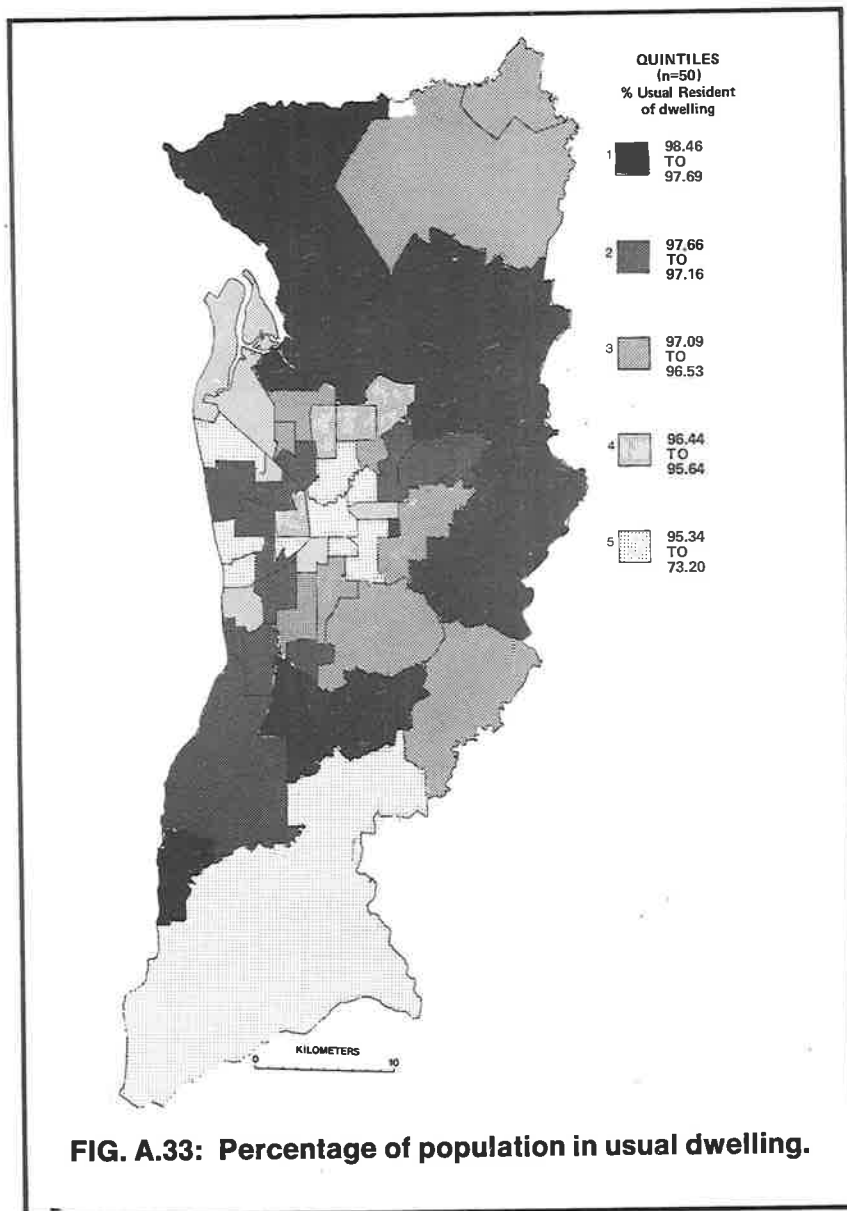

Source: Data supplied by A.B.S. Census, June 1971.

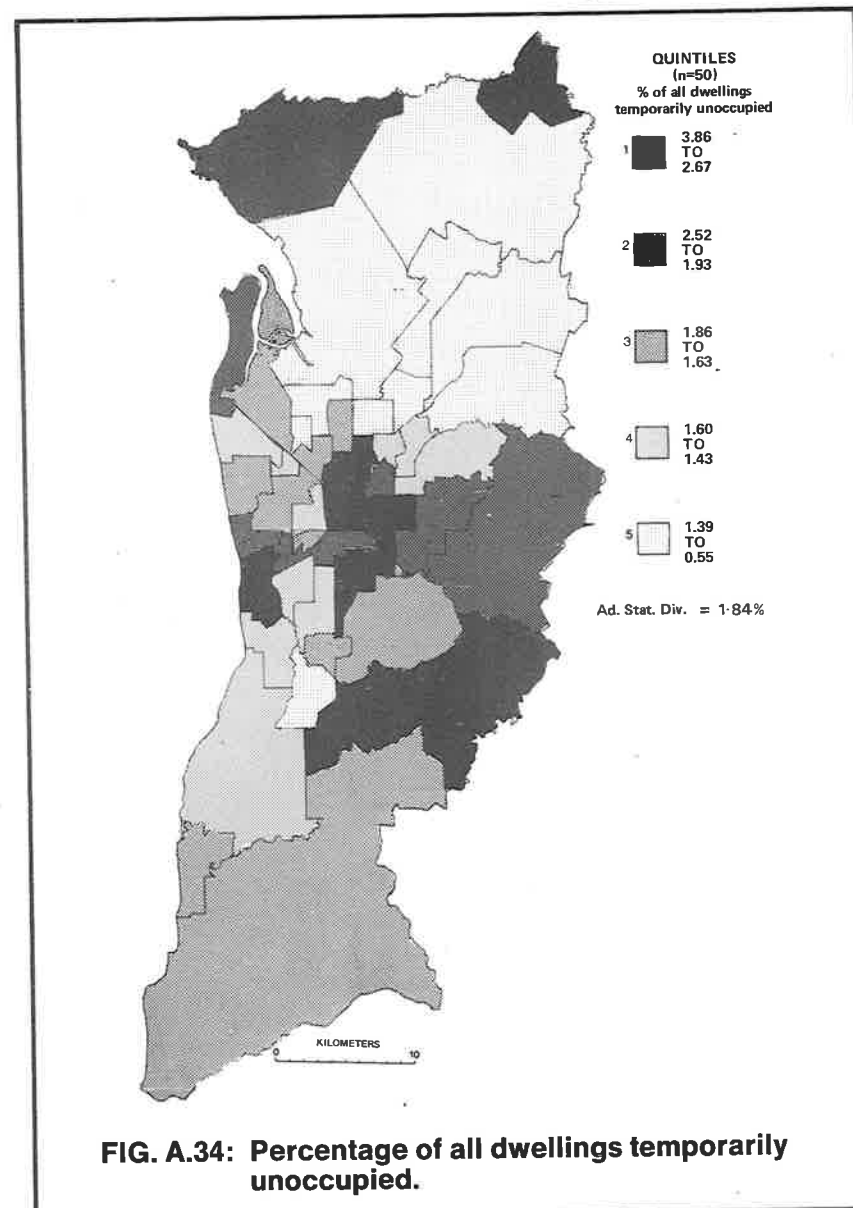

Source: Data supplied by A.B.S. Census, June 1971.

APPENDIX B

Population age pyramids for the whole Adelaide Statistical Division
and each of its fifty electoral subdivisions,

Source: Reprocessing of census data, 30 June 1971, from
Australian Bureau of Statistics, Adelaide.

ADELAIDE STATISTICAL DIVISION

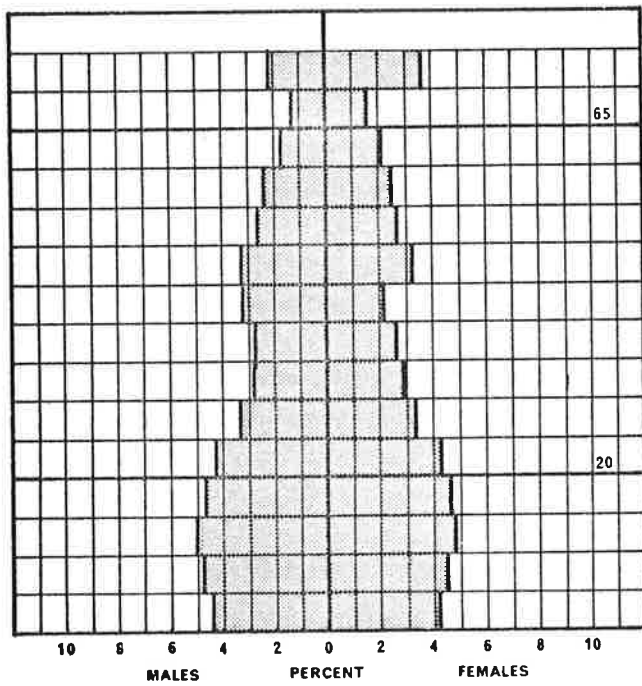

S. D.

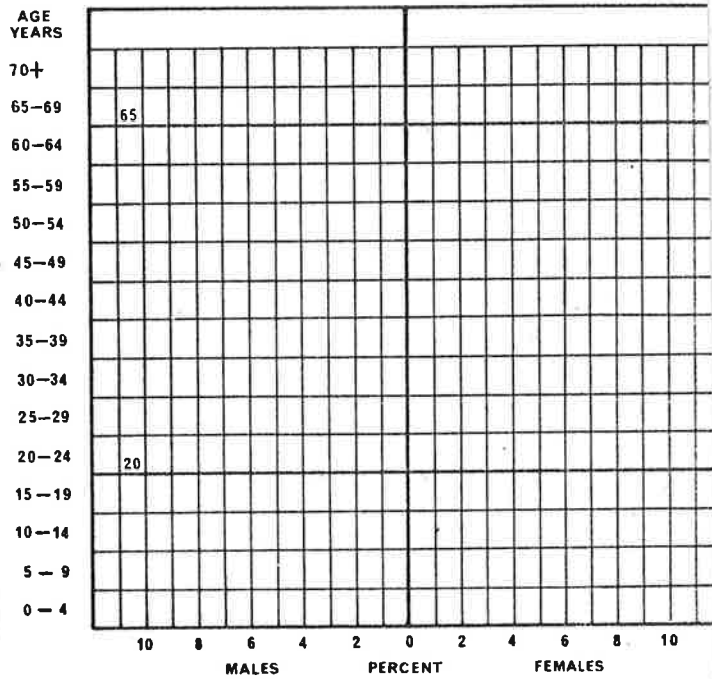

POPULATION AGE STRUCTURES

S. D. 711 ADELAIDE

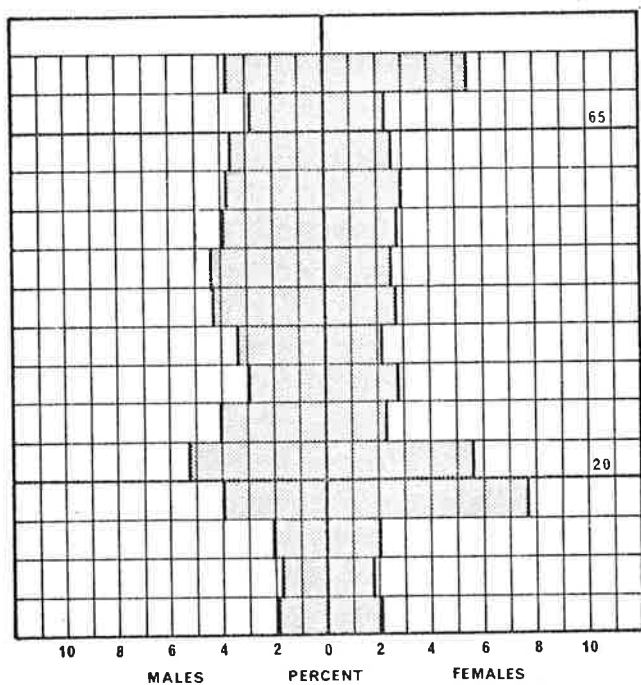

S. D. 712 FLOREY WEST

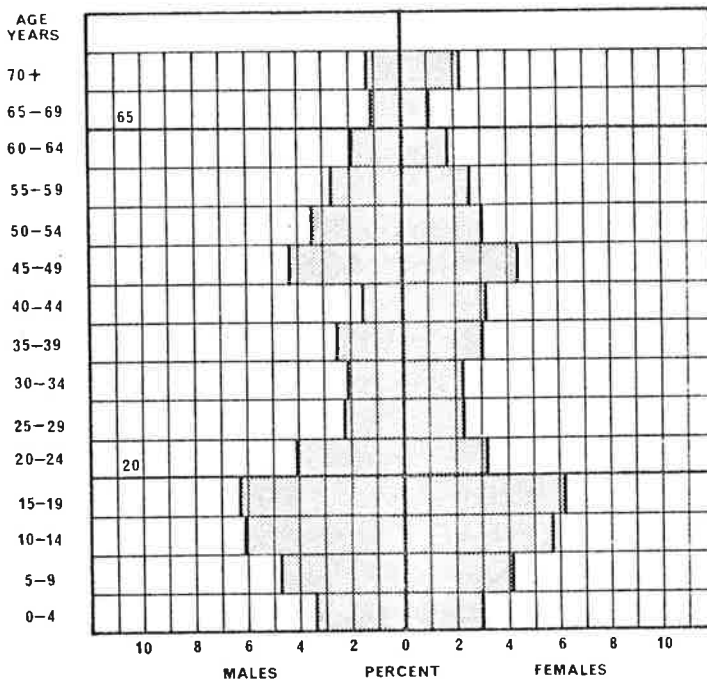

S. D. 713 GILLES WEST

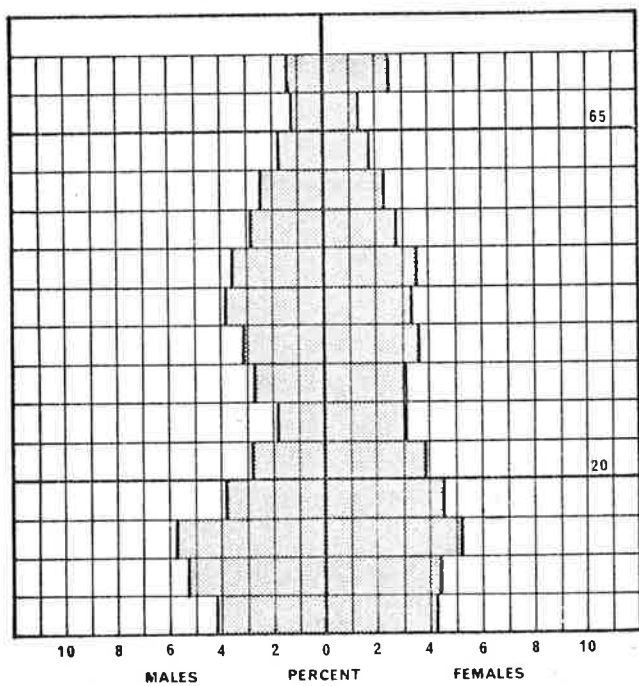

S. D. 714 ROSS SMITH

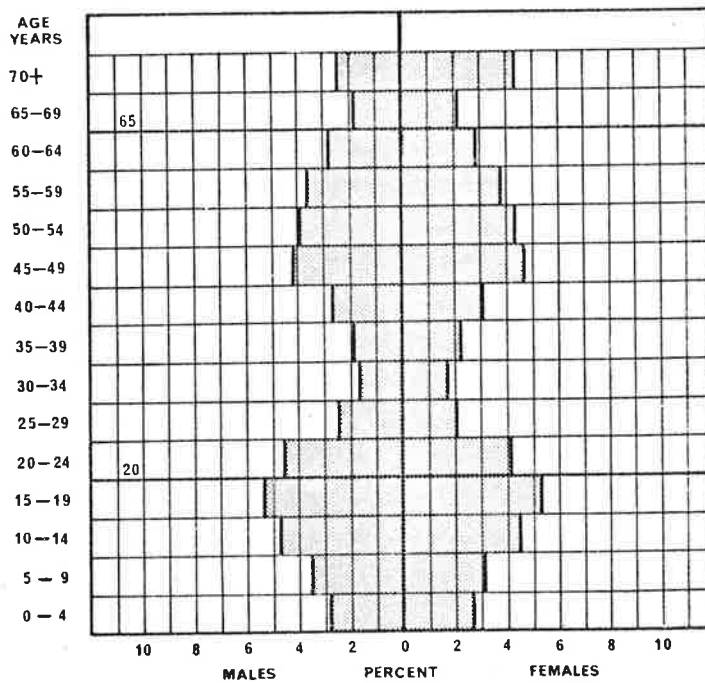

POPULATION AGE STRUCTURES

S. D. 715 ST. PETERS

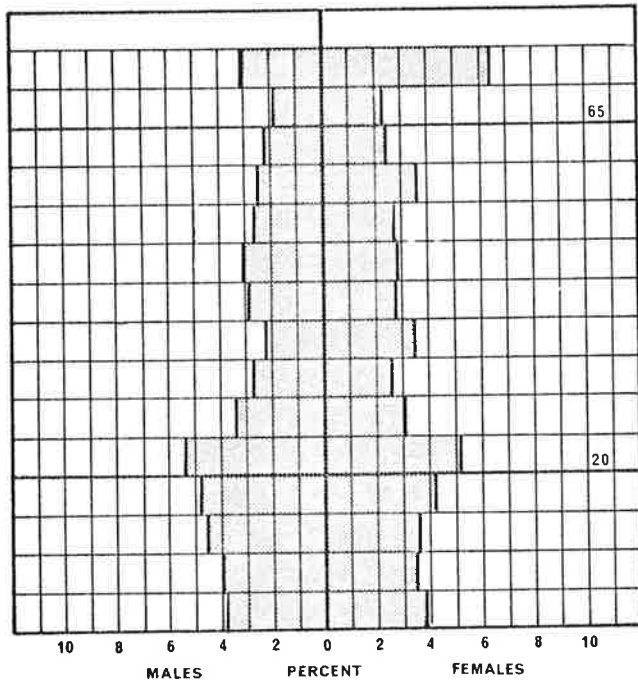

S. D. 716 TORRENS

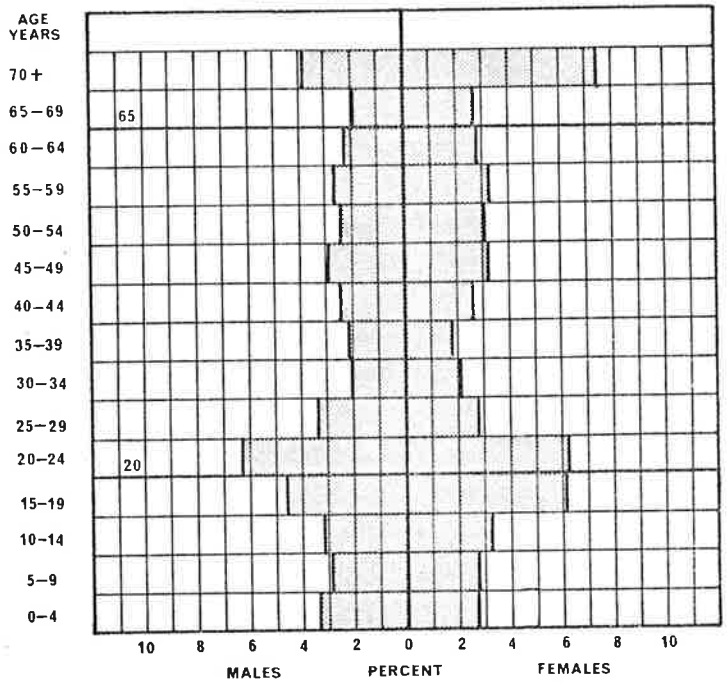

S. D. 722 FISHER EAST

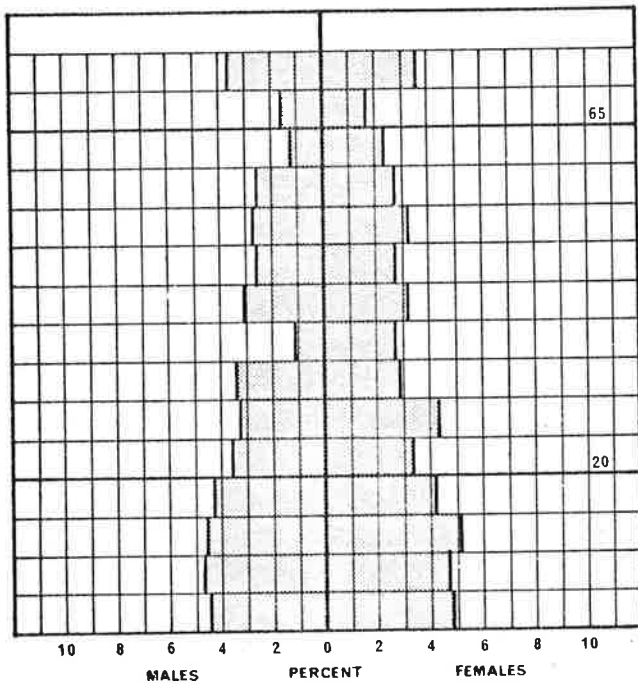

S. D. 724 HEYSEN NORTH (PT)

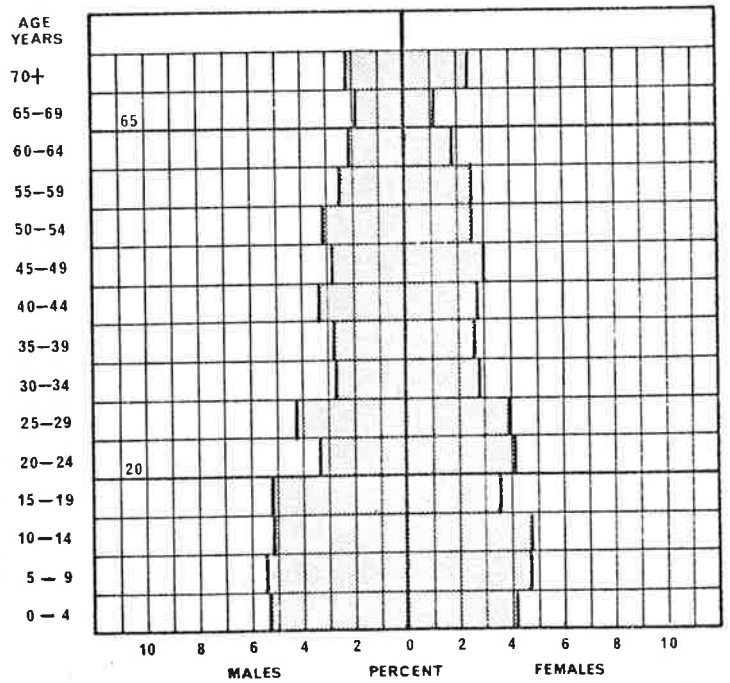

POPULATION AGE STRUCTURES

S. D. 730 - ALEXANDRA (PT)

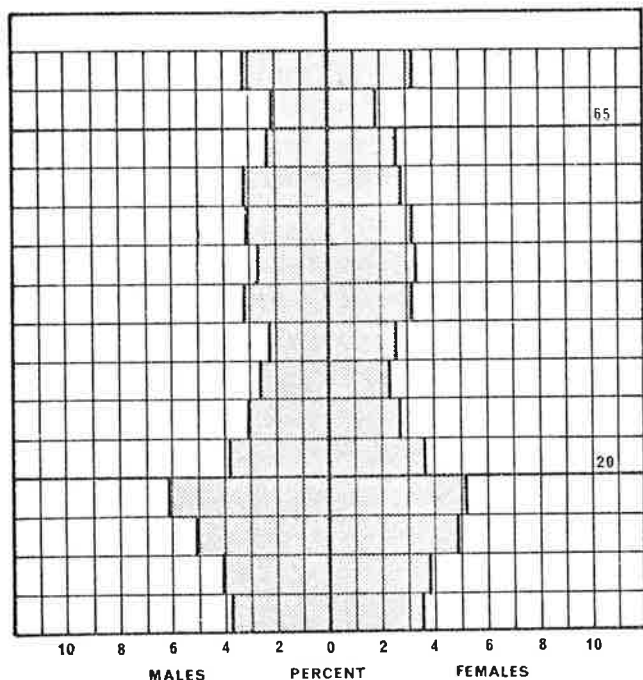

S. D. 731 - FISHER EAST

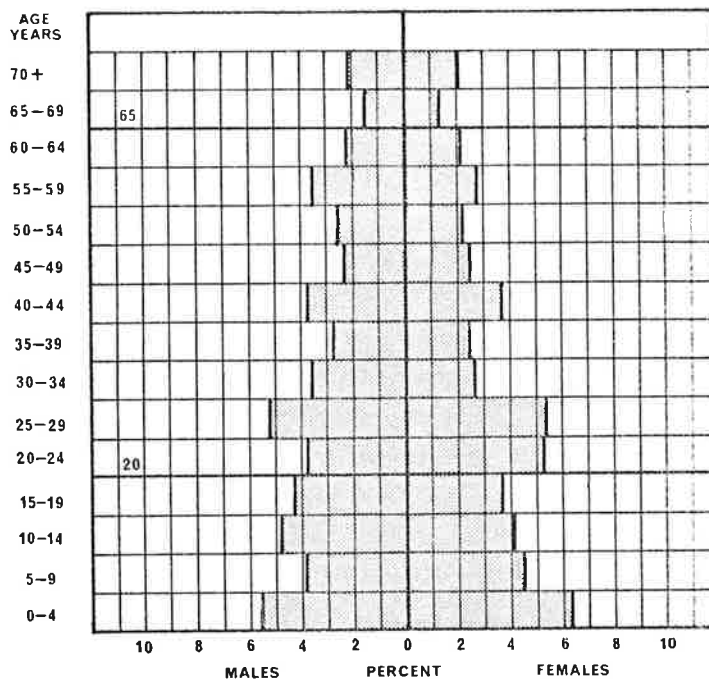

S. D. 732 - FLAGSTAFF HILL

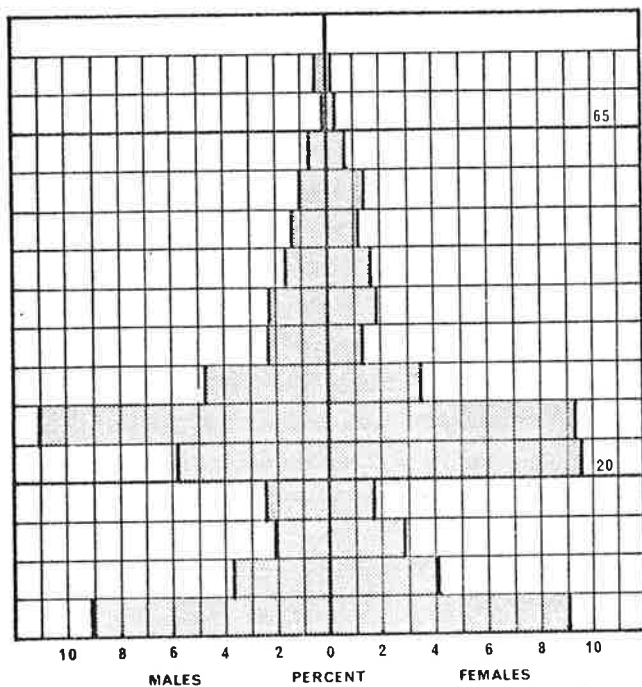

S. D. 736 - MOANA

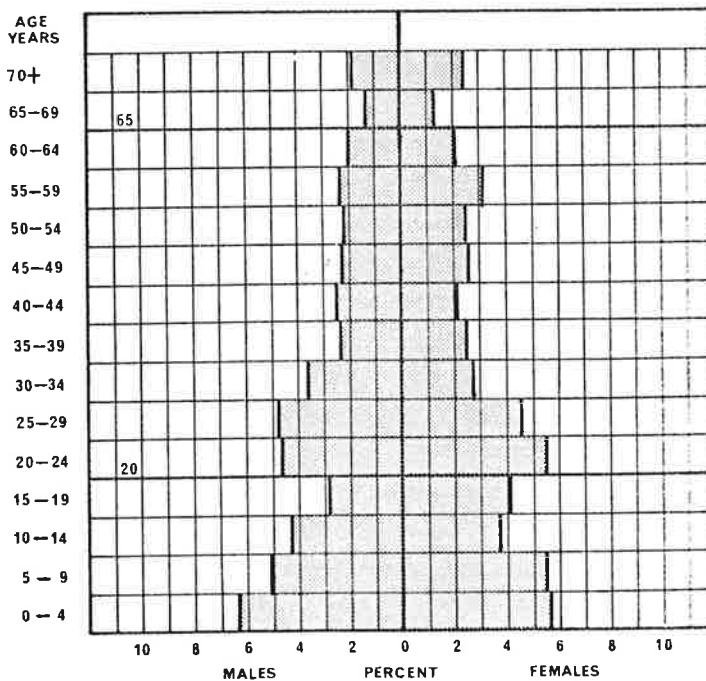

POPULATION AGE STRUCTURES

S. D. 741 ELIZABETH

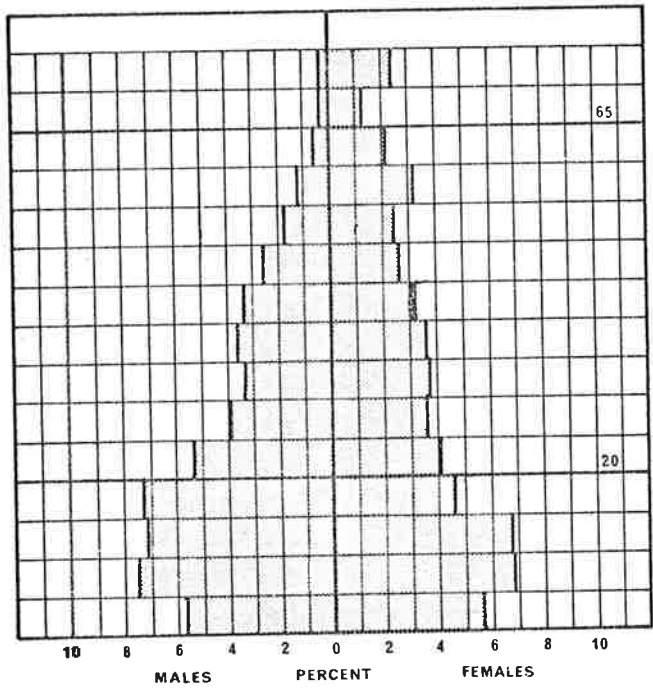

S. D. 742 FLOREY EAST

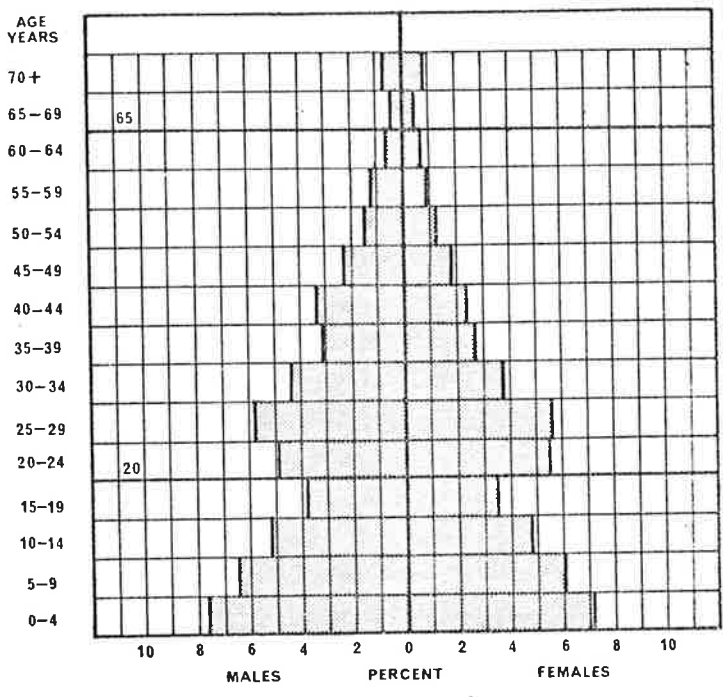

S. D. 743 MODBURY NORTH

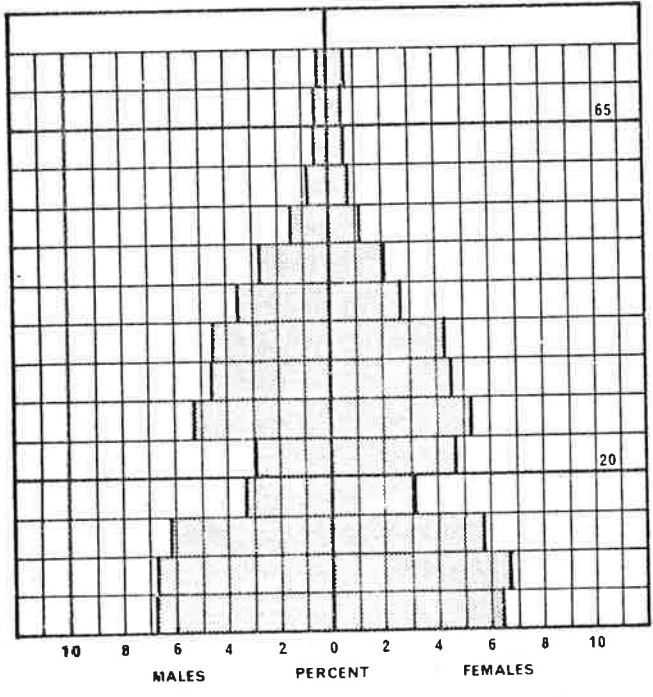

S. D. 744 PLAYFORD

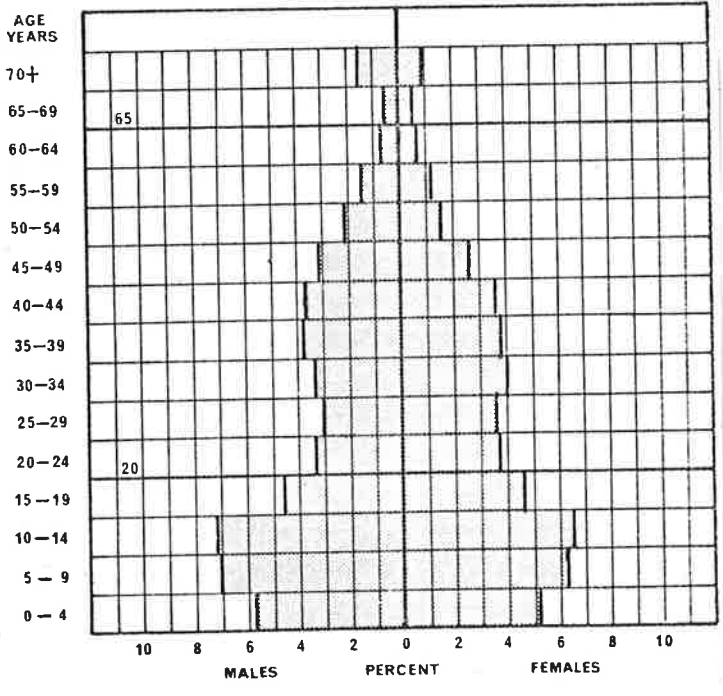

POPULATION AGE STRUCTURES

S. D. 745 SALISBURY

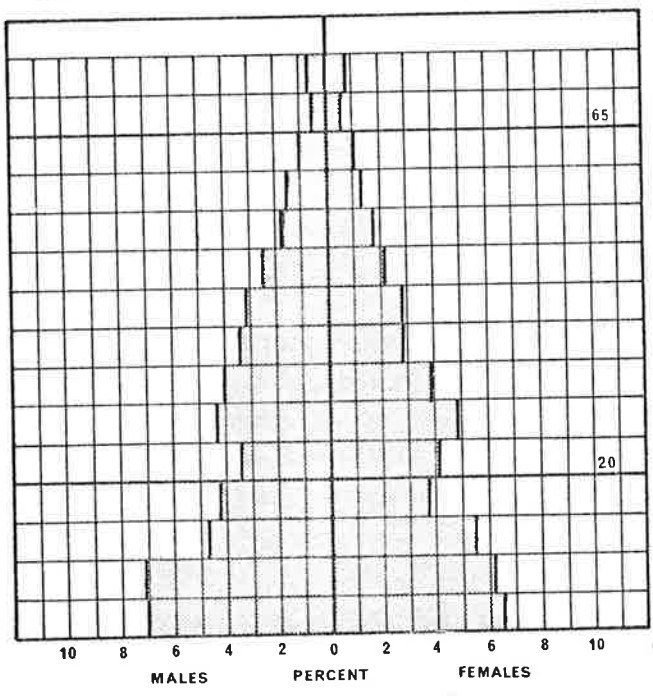

S. D. 751 BRAGG

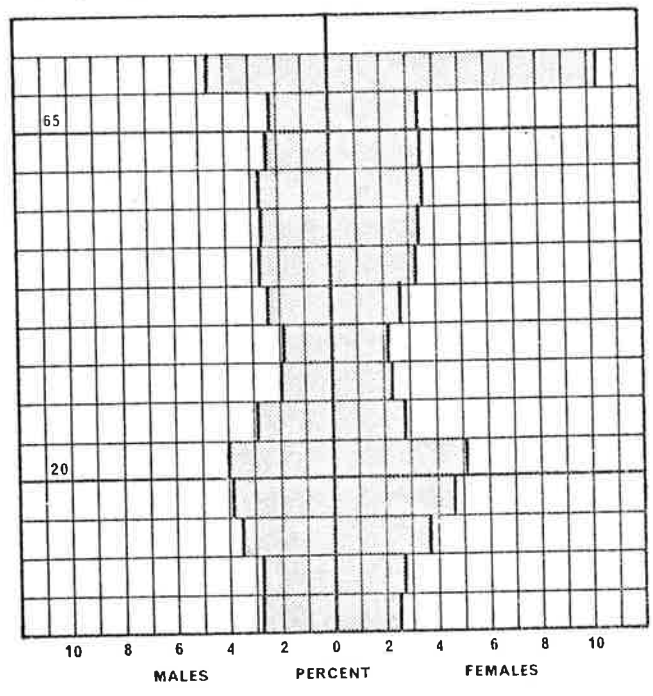

S. D. 752 FISHER NORTH

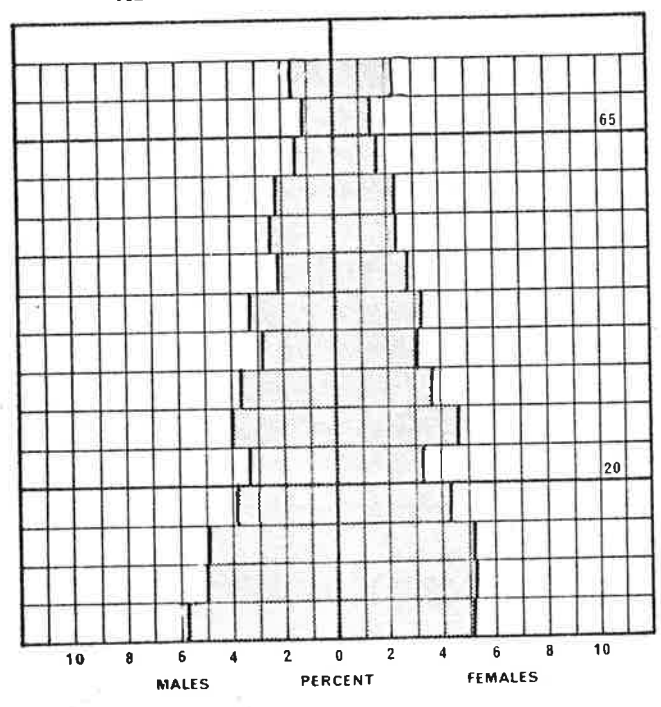

S. D. 753 LEABROOK

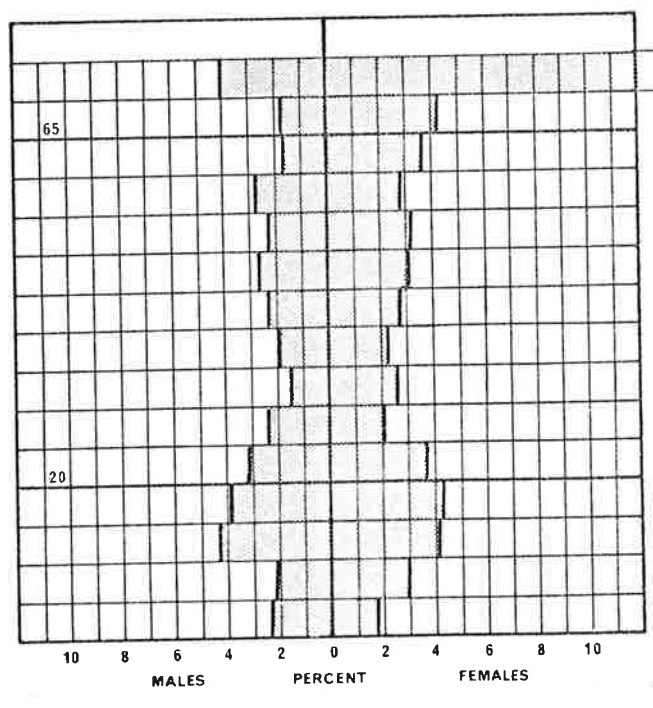

POPULATION AGE STRUCTURES

S. D. 754 - MITCHAM

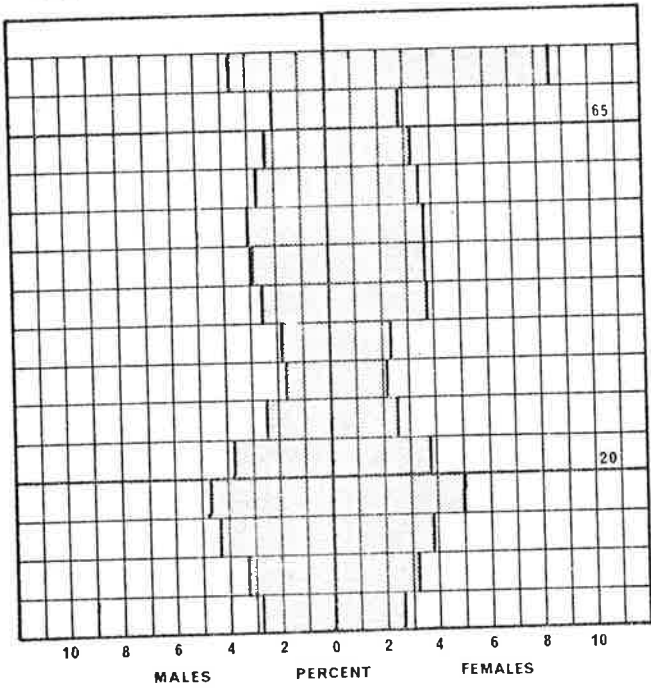

S. D. 755 - NORWOOD

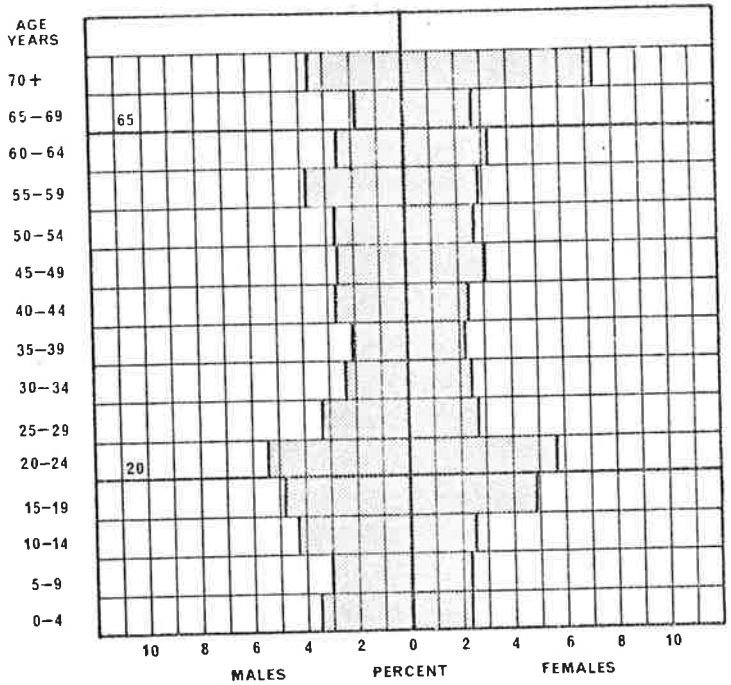

S. D. 756 - UNLEY

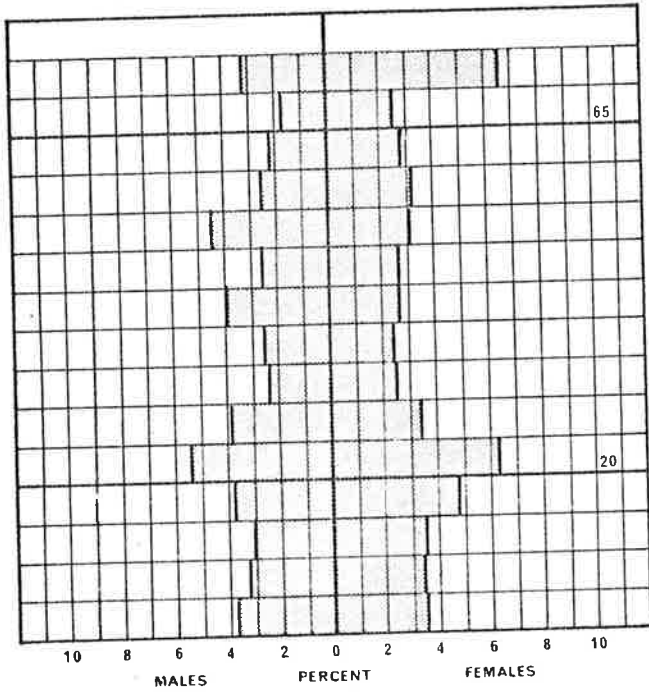

S. D. 771 - ASCOT PARK

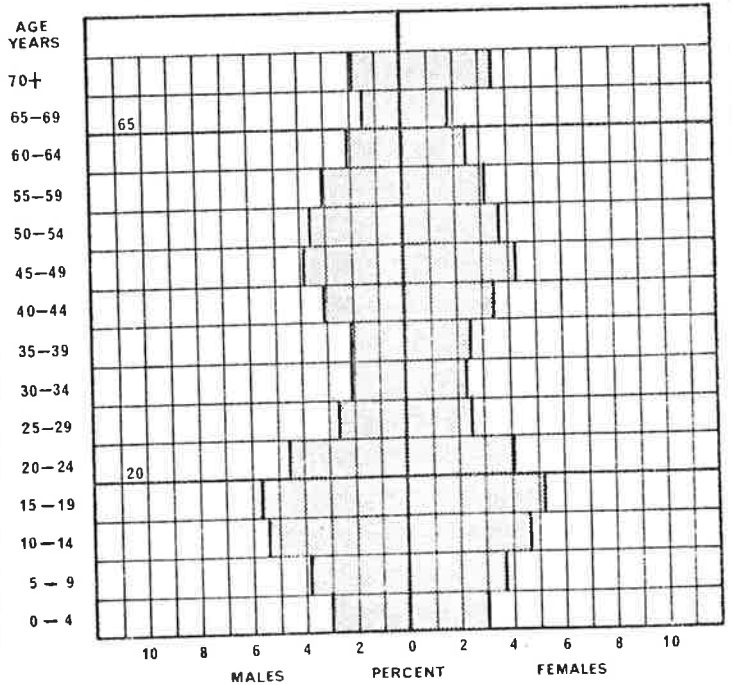

POPULATION AGE STRUCTURES

S. D. 772 - FISHER WEST

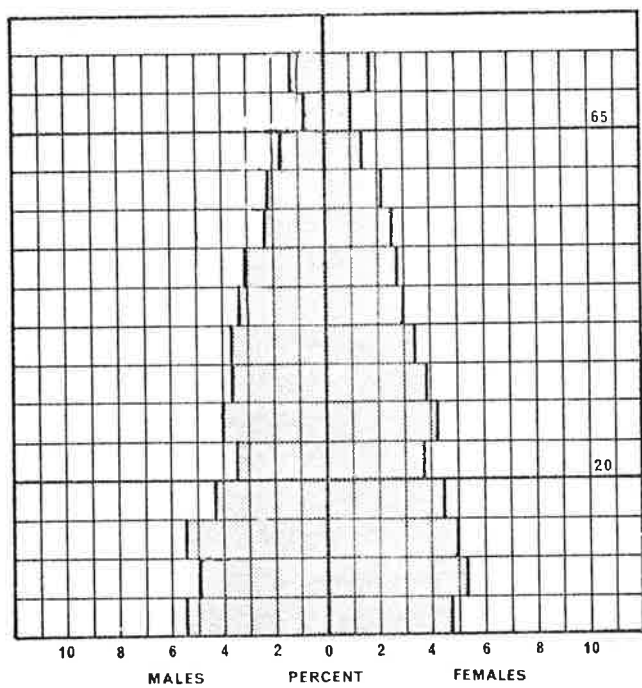

S. D. 773 - GOODWOOD

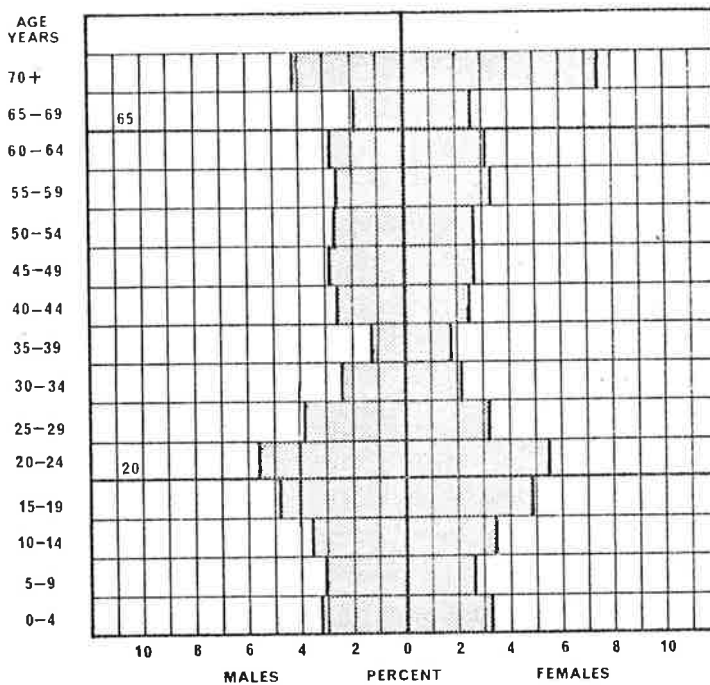

S. D. 774 - HANSON EAST

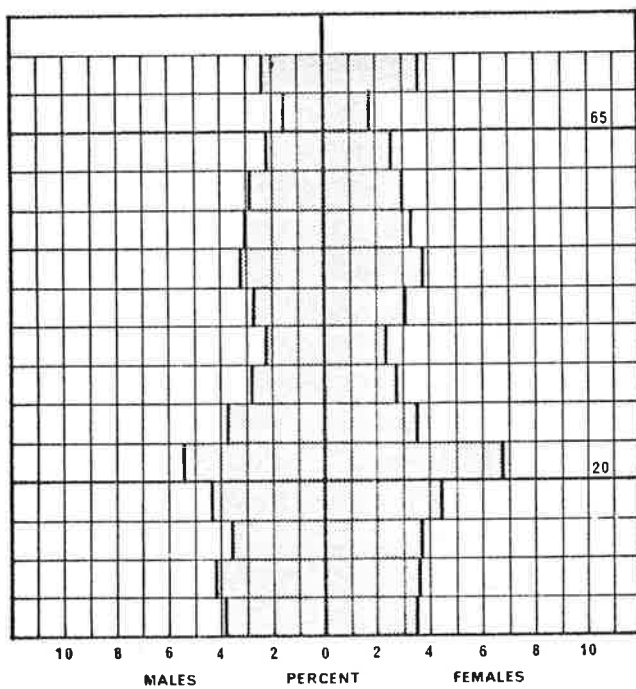

S. D. 775 - MARLESTON

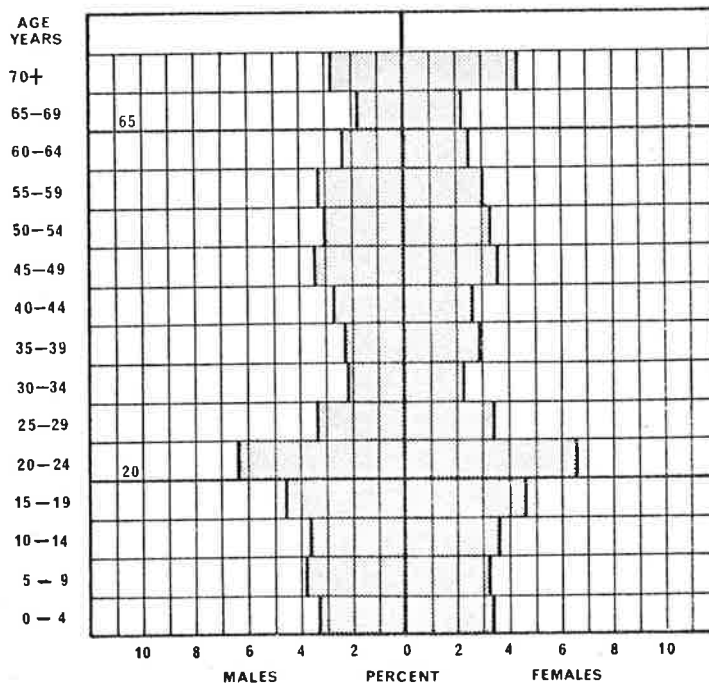

POPULATION AGE STRUCTURES

S. D. 776 - MITCHELL

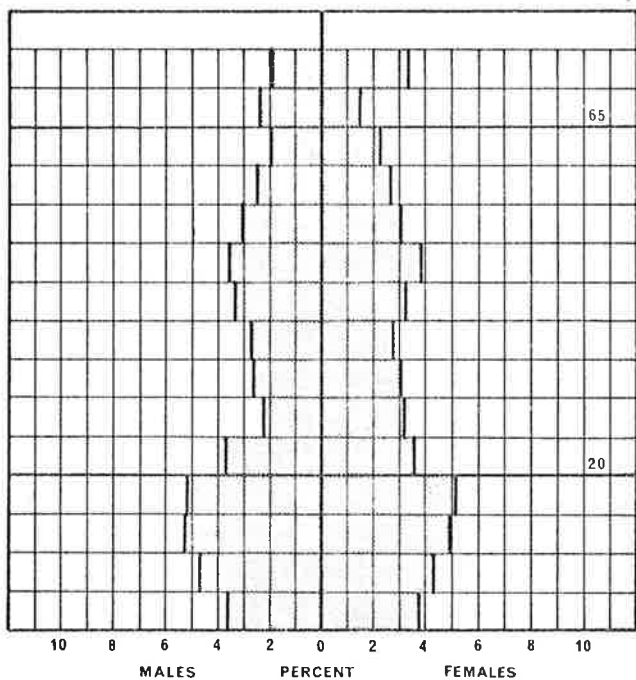

S. D. 781 - BEVERLEY

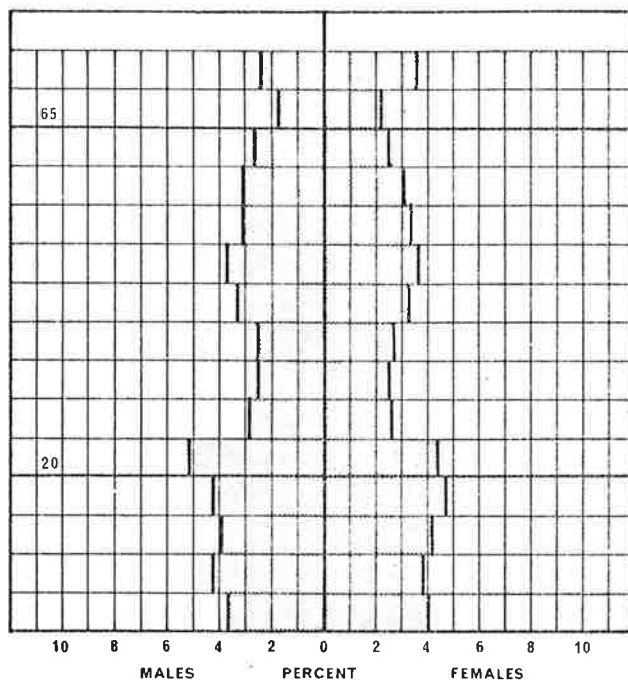

S. D. 782 - HANSON NORTH

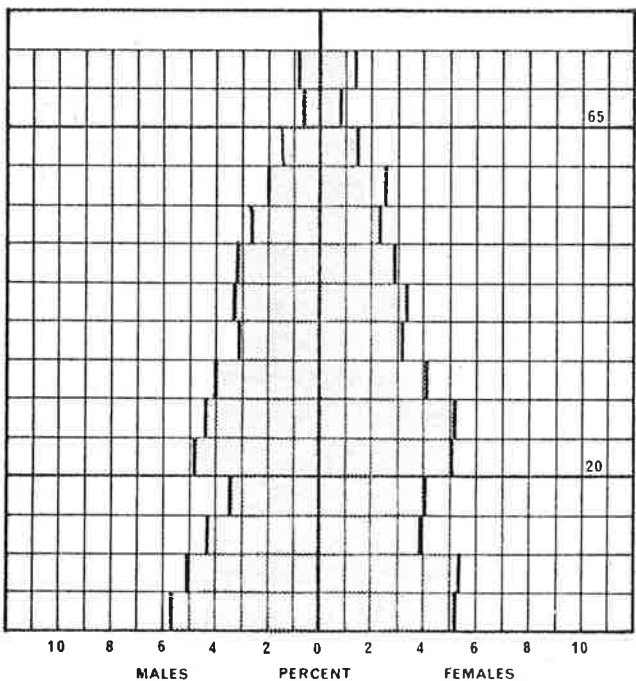

S. D. 783 - HENLEY BEACH

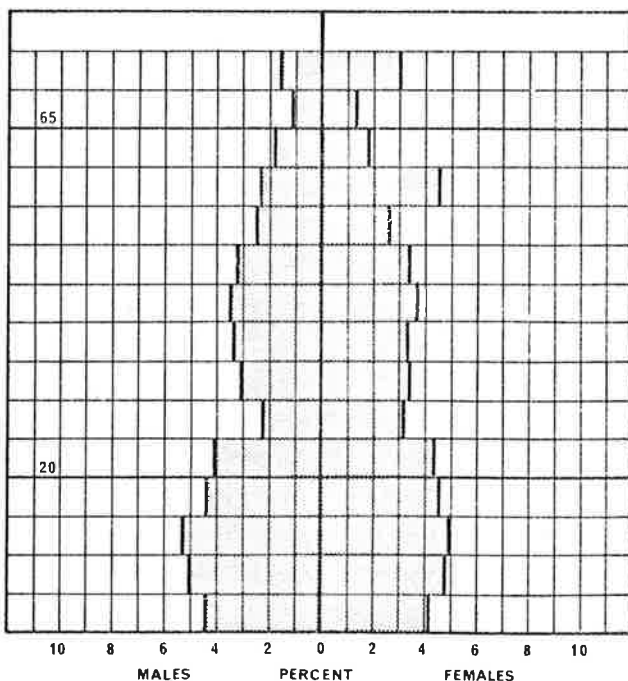

POPULATION AGE STRUCTURES

S. D. 784 - PEAKE

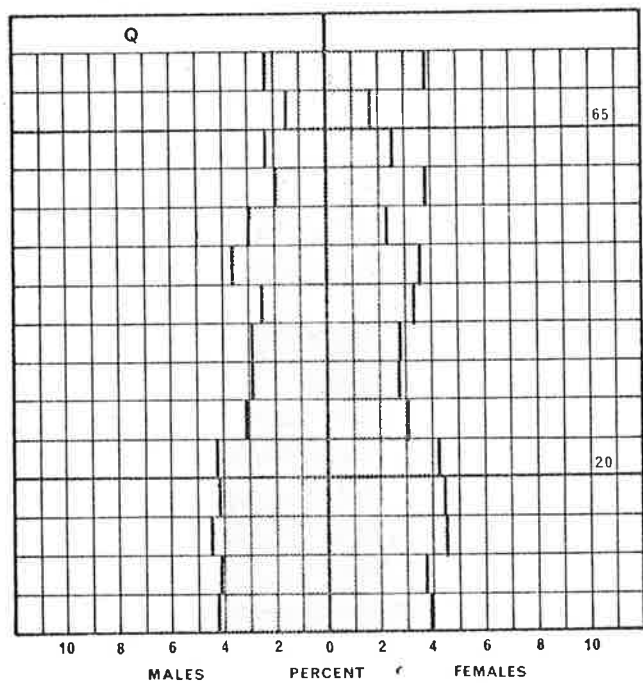

S. D. 785 - SPENCE SOUTH

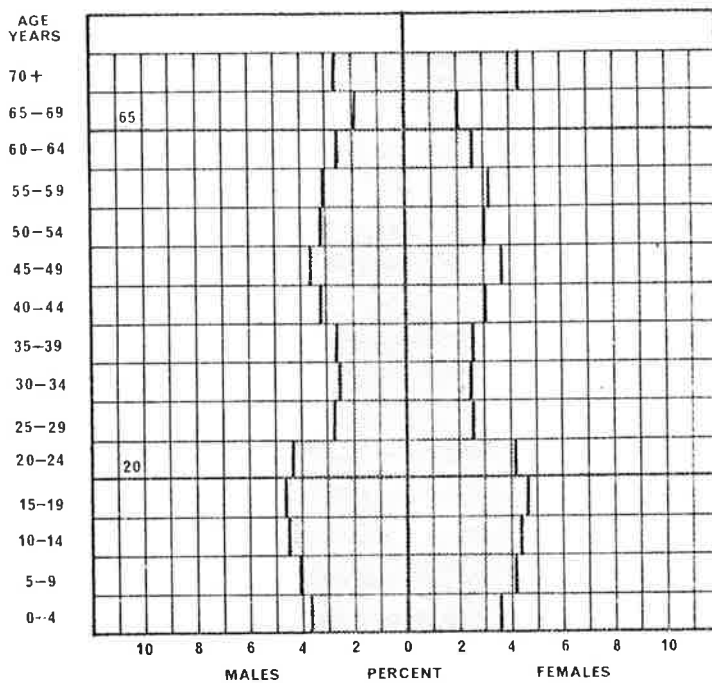

S. D. 786 - THEBARTON

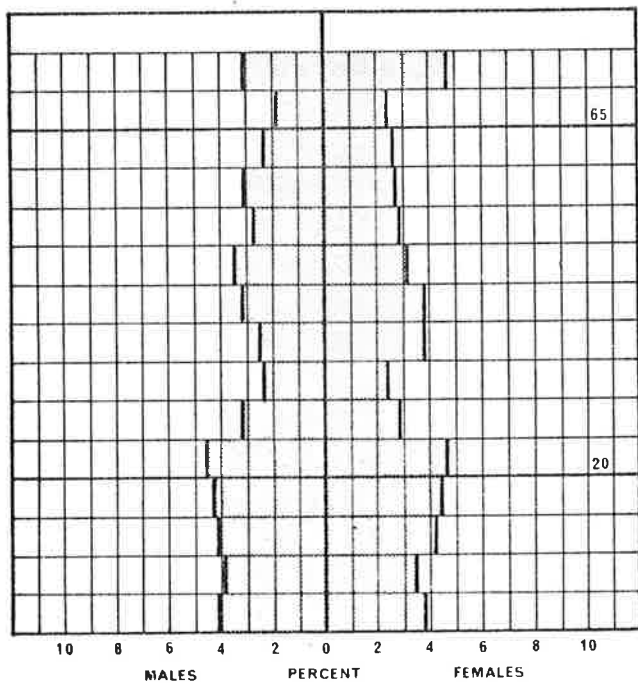

S. D. 791 - BRIGHTON

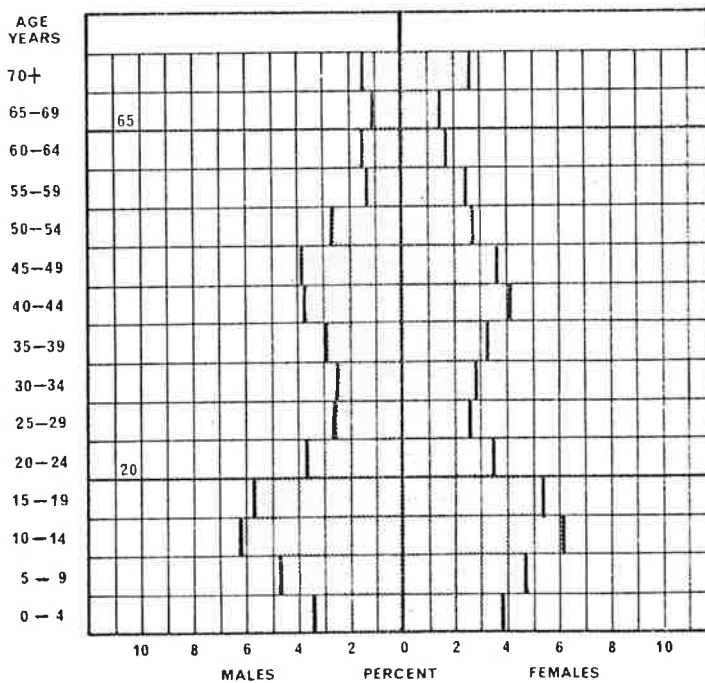

POPULATION AGE STRUCTURES

S. D. 792 - GLENELG

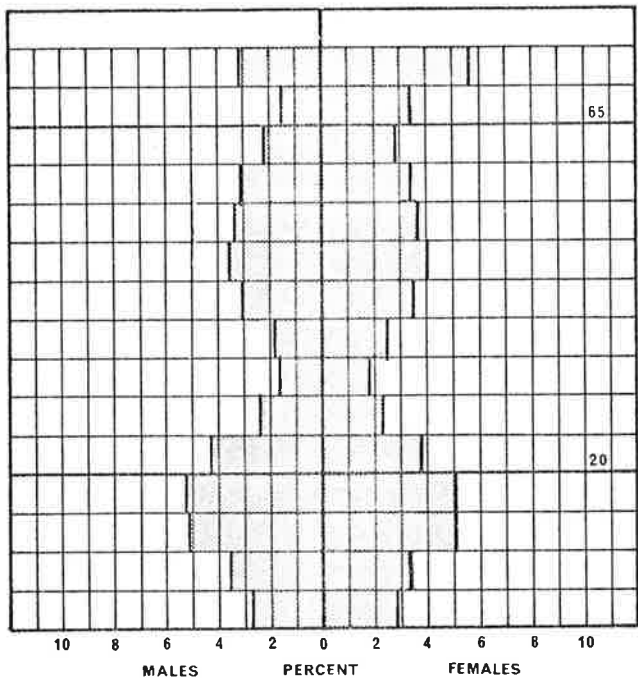

S. D. 793 - HANSON SOUTH

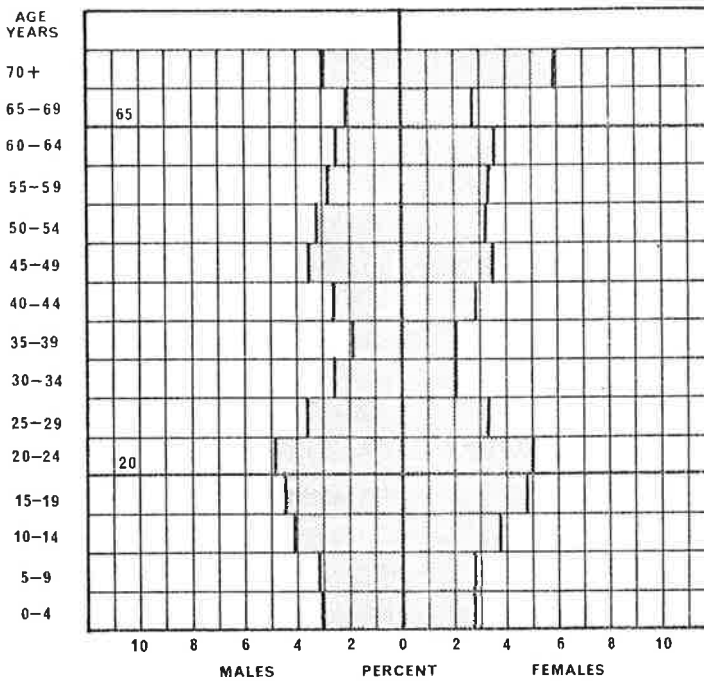

S. D. 794 - MAWSON

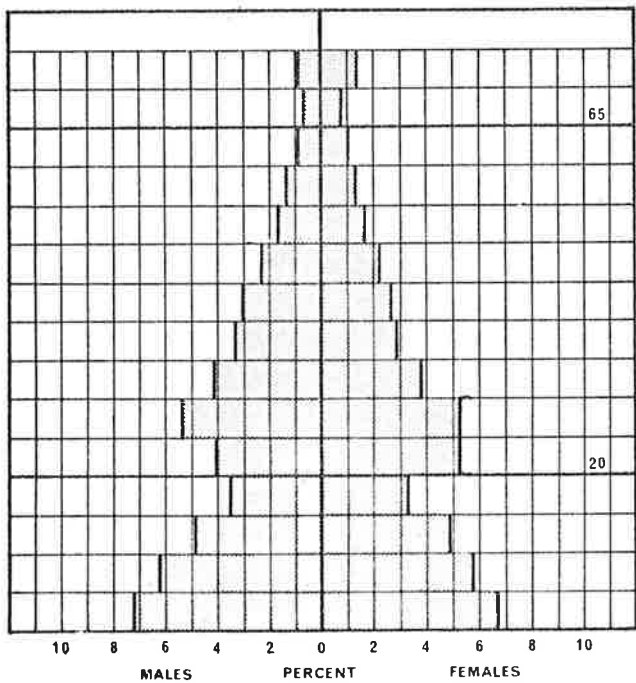

S. D. 801 - ALBERT PARK

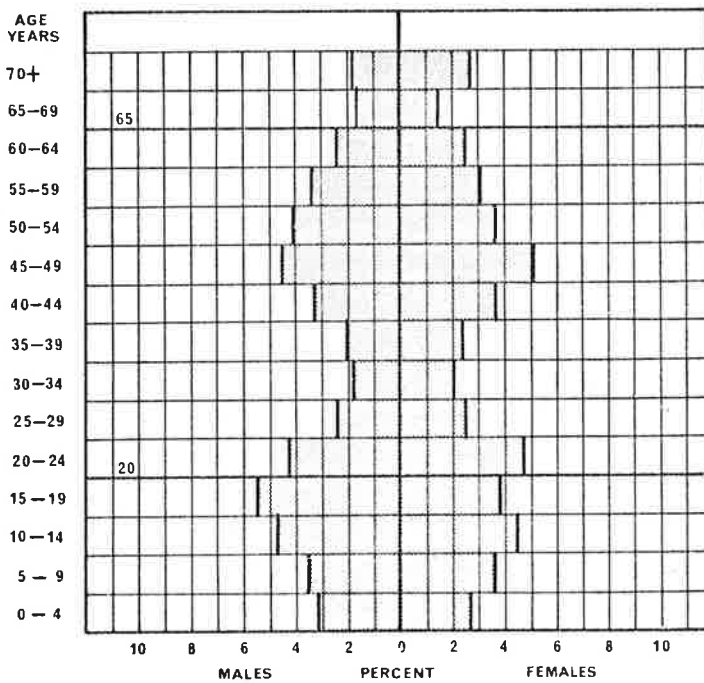

POPULATION AGE STRUCTURES

S. D. 802-ANGLE PARK

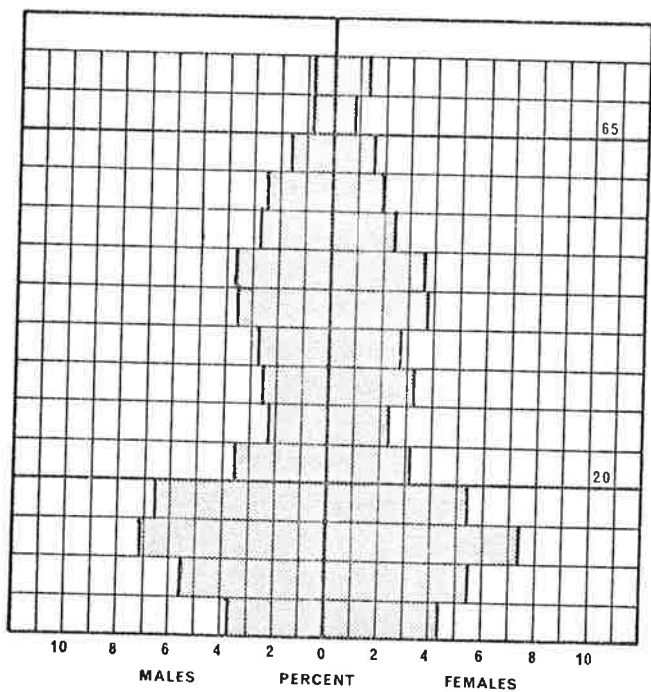

S. D. 803-PRICE

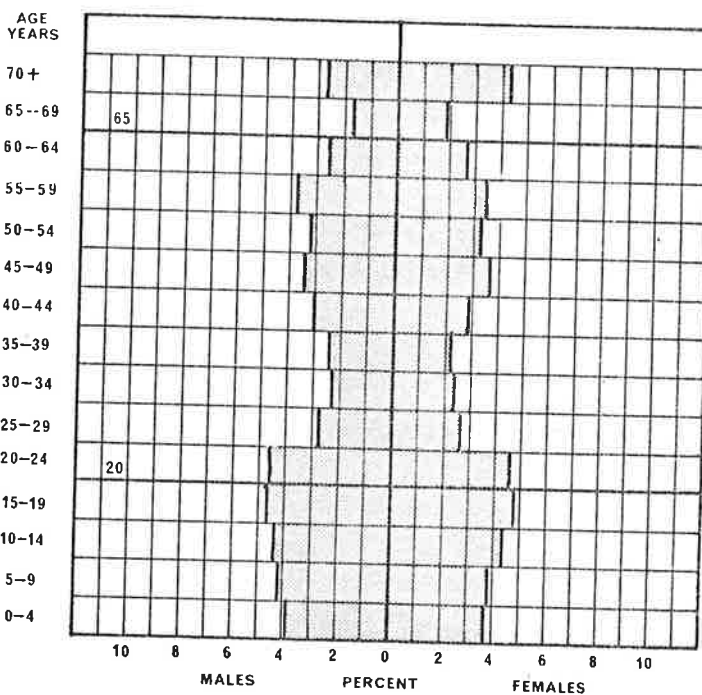

S. D. 804-SEMAPHORE

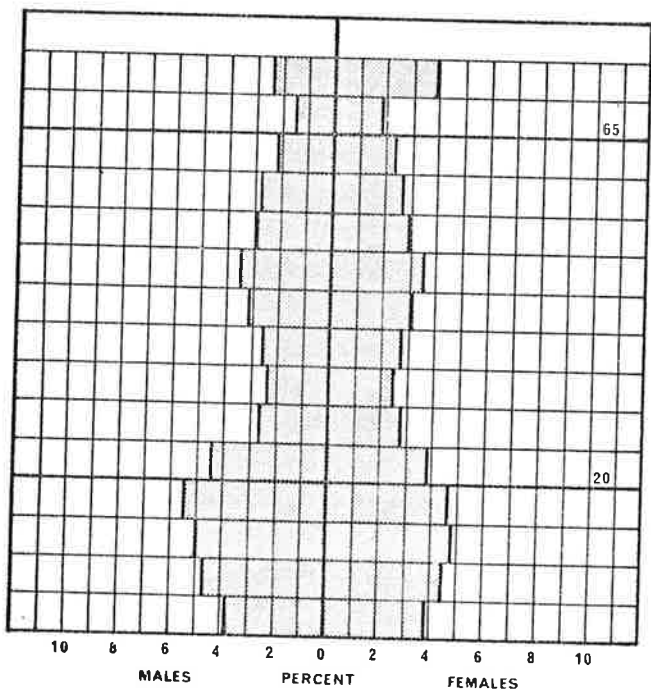

S. D. 805-SPENCE NORTH

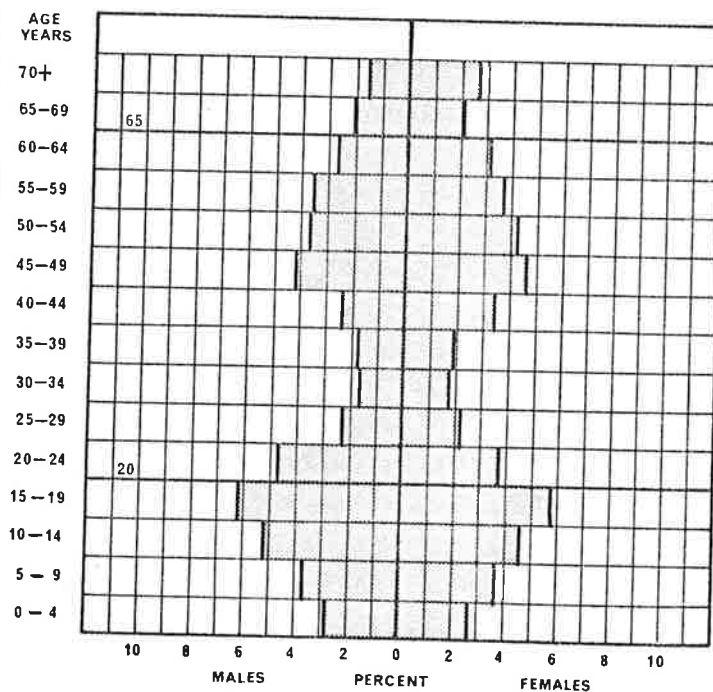

POPULATION AGE STRUCTURES

S. D. 811-COLES

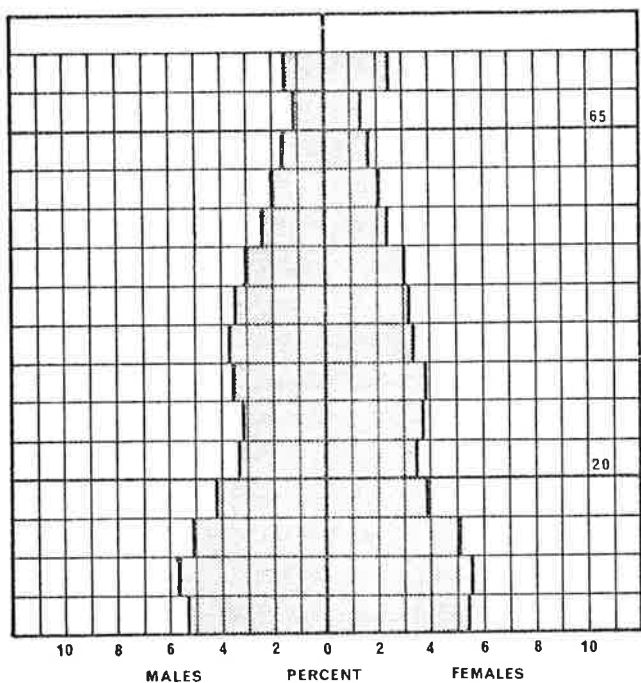

S. D. 812-DAVENPORT

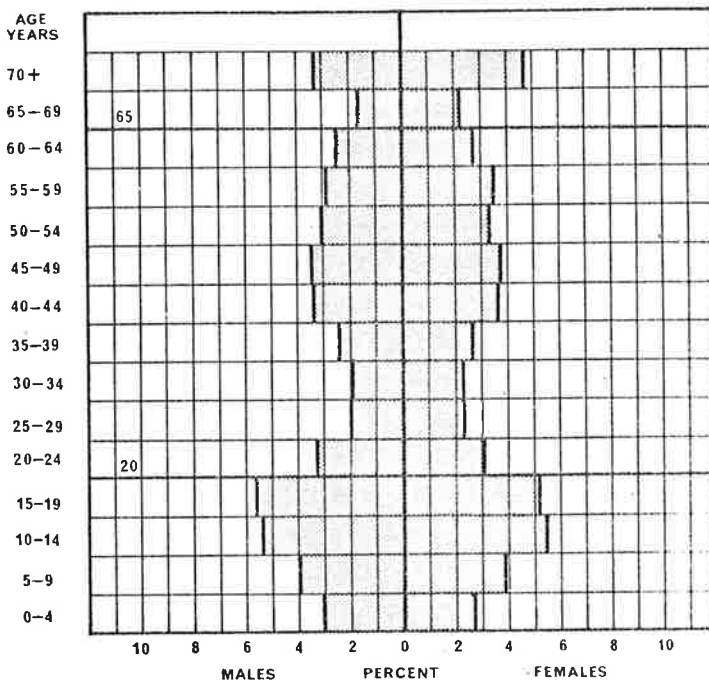

S. D. 813-GILLES EAST

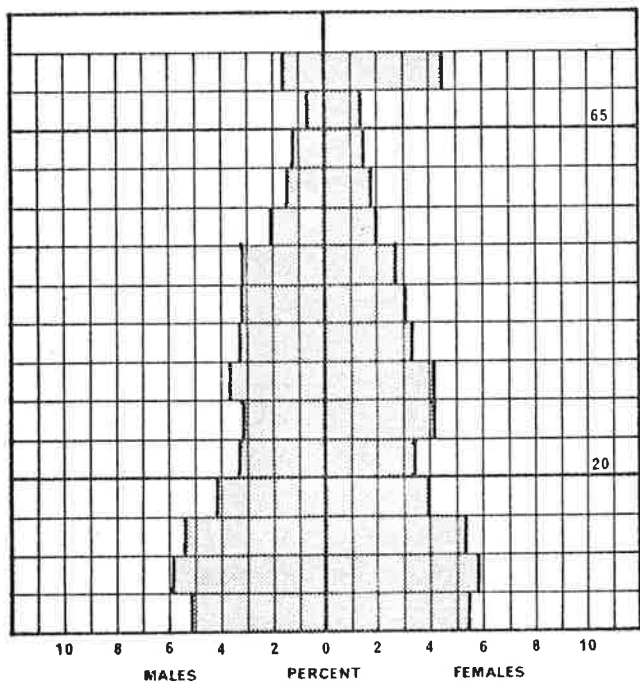

S. D. 814-HIGHBURY

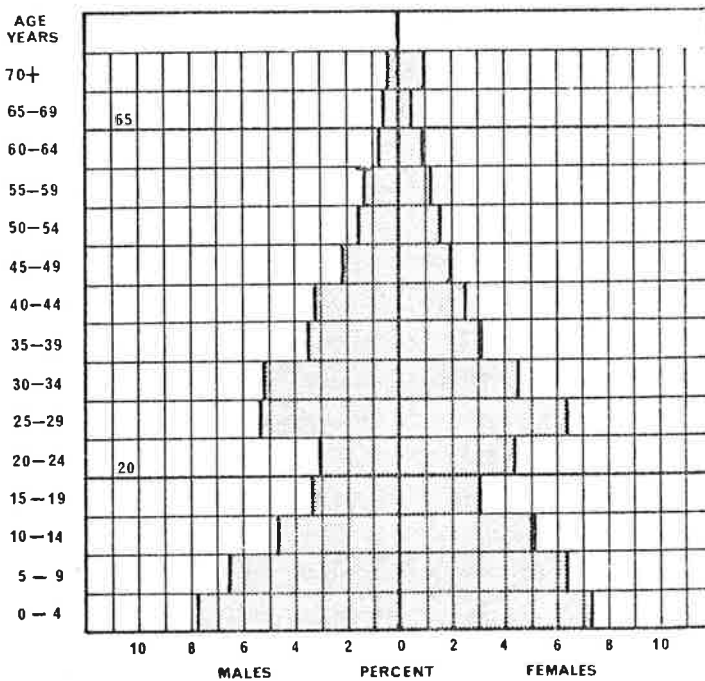

POPULATION AGE STRUCTURES

S. D. 823- GOYDER (PT)

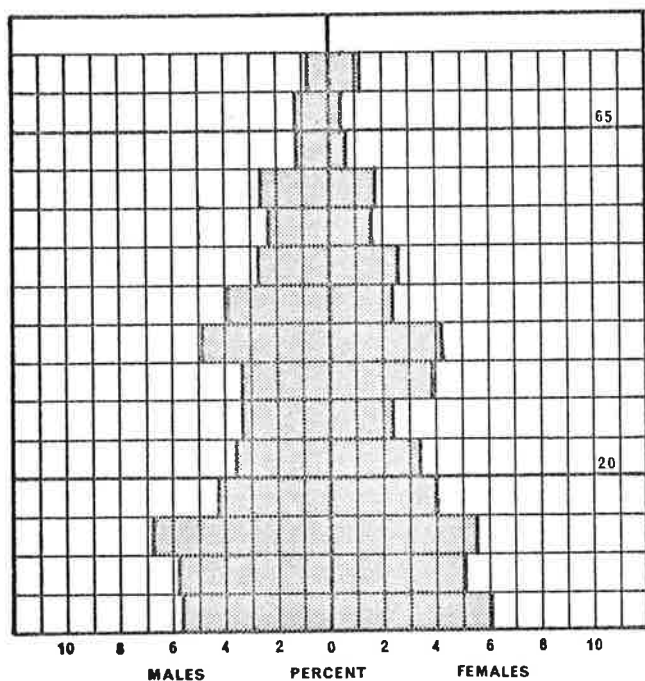

S. D. 824- LIGHT NORTH (PT)

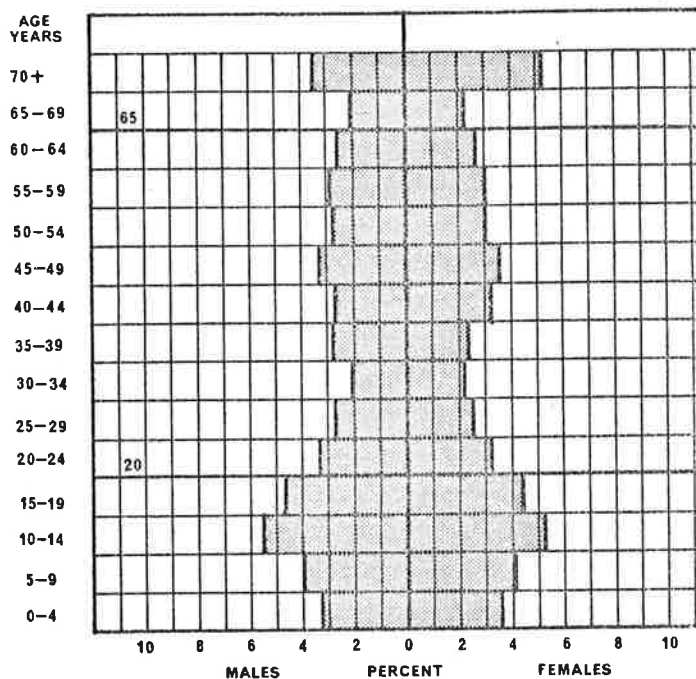

APPENDIX C

Graphs for the whole Adelaide Statistical Division and each of its fifty electoral subdivisions showing the age structure of the total population and Coulson's Age Structure Index,

Source: Author's reprocessing of census data, 30 June, 1971, from Australian Bureau of Statistics, Adelaide,

POPULATION AGE STRUCTURES
HISTOGRAMS AND INDICES

ADELAIDE STATISTICAL DIVISION

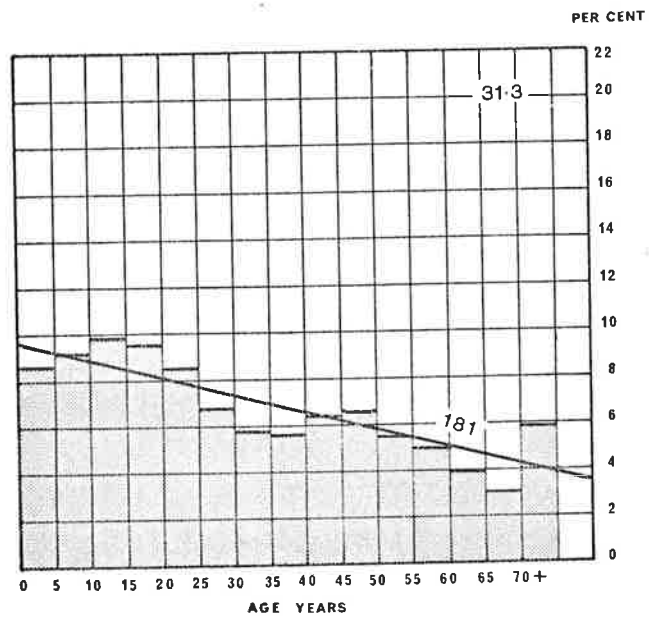

POPULATION AGE STRUCTURES
HISTOGRAMS AND INDICES

S. D. 711 - ADELAIDE

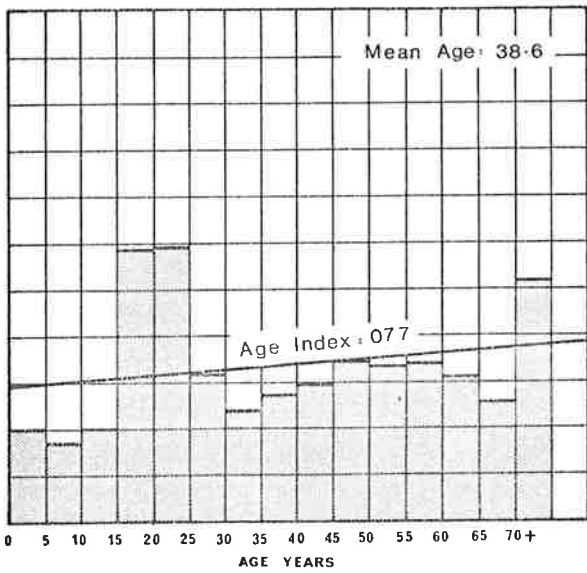

S. D. 712 - FLOREY WEST

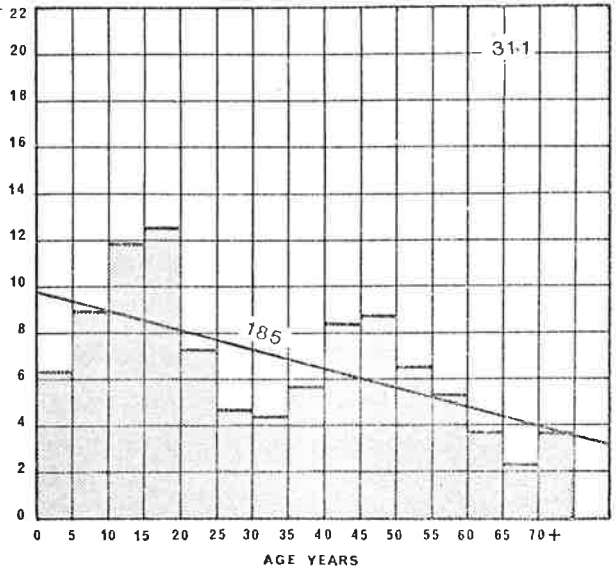

S. D. 713 - GILLES WEST

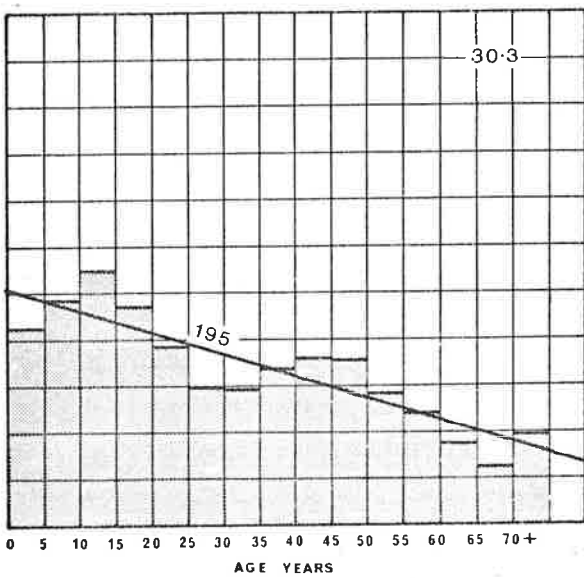

S. D. 714 - ROSS SMITH

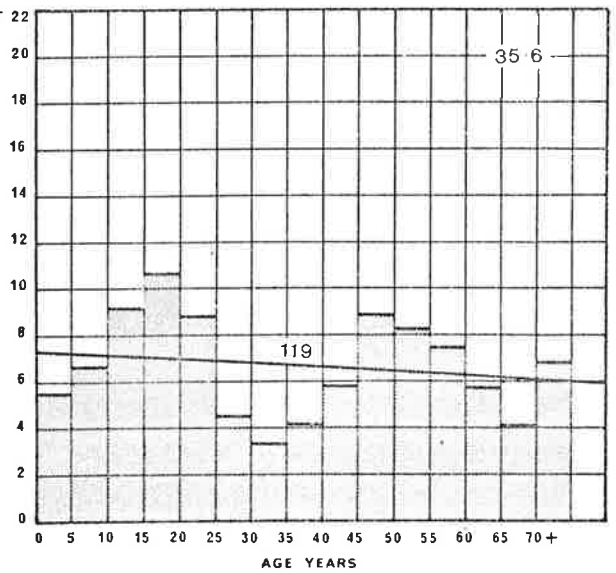

POPULATION AGE STRUCTURES
HISTOGRAMS AND INDICES

S. D. 715 - ST. PETERS

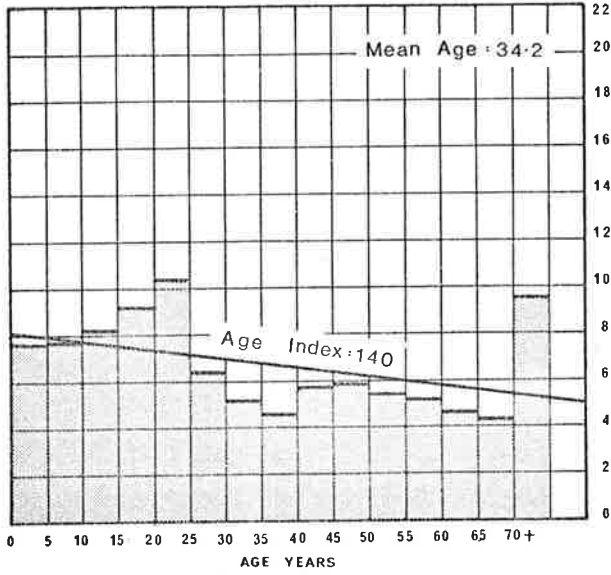

S. D. 716 - TORRENS

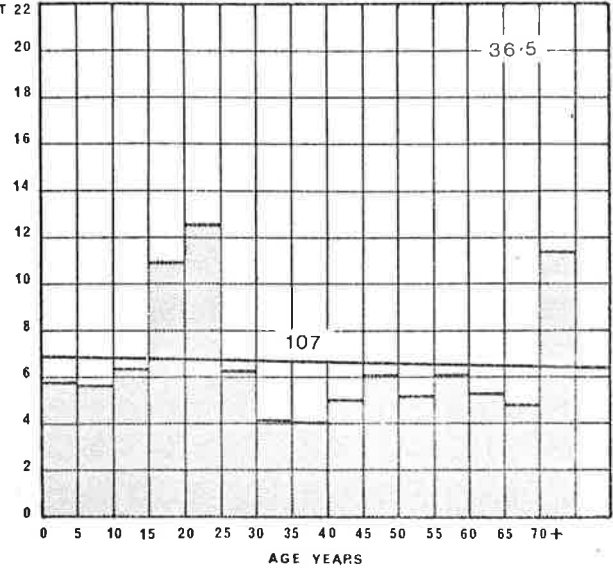

S. D. 722 - FISHER EAST

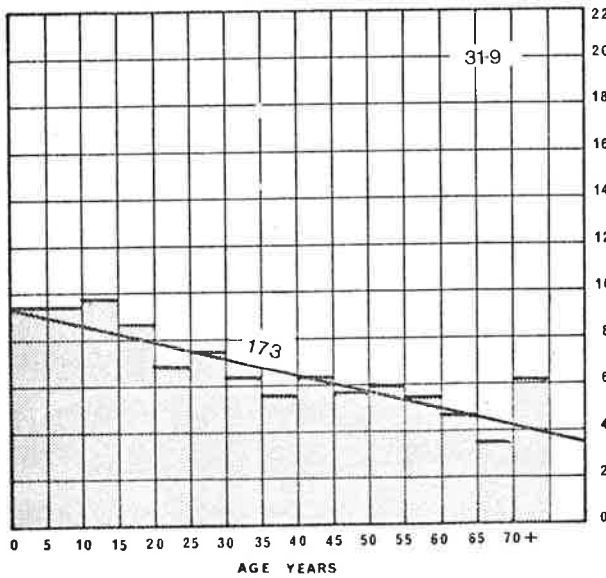

S. D. 724 - HEYSON NORTH(PT)

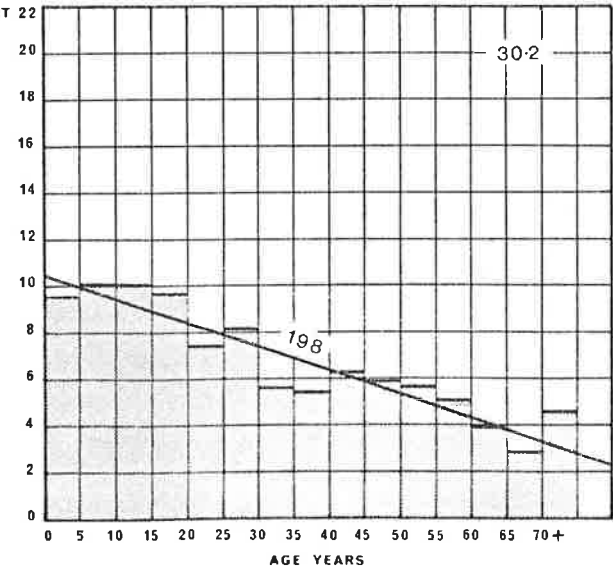

POPULATION AGE STRUCTURES
HISTOGRAMS AND INDICES

S. D. 730 -ALEXANDRA (PT)

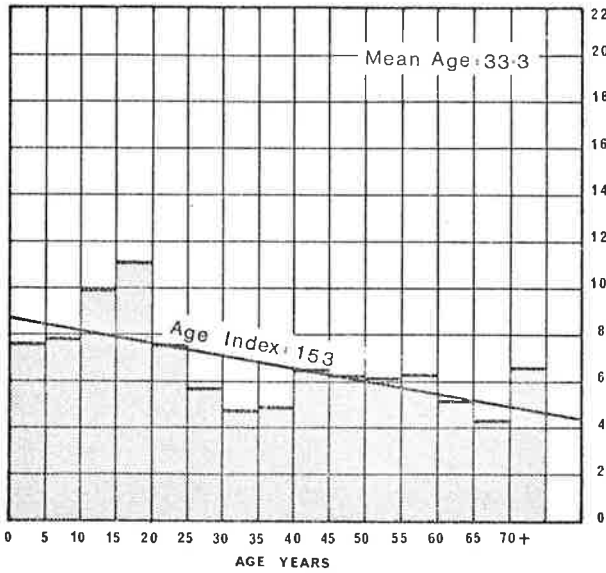

S. D. 731 -FISHER SOUTH

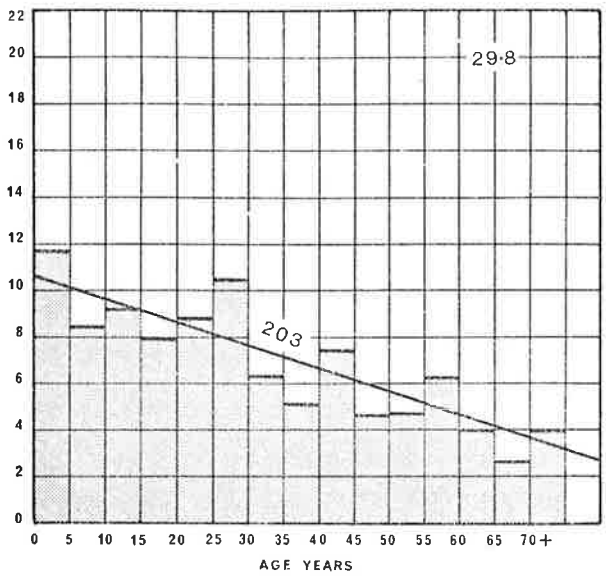

S. D. 732 -FLAGSTAFF HILL

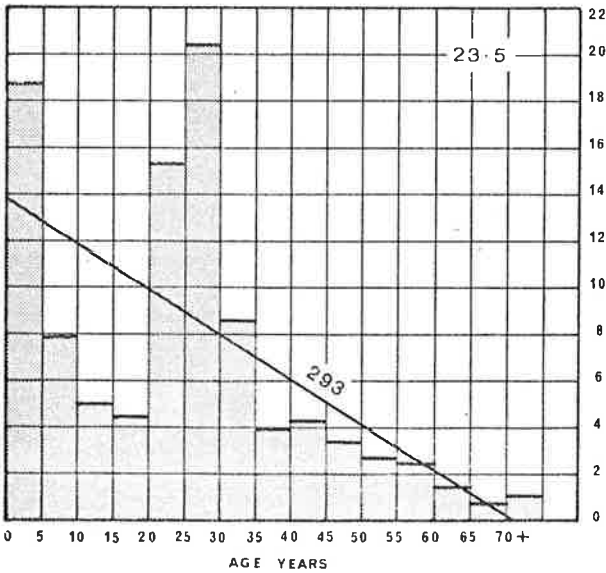

S. D. 736 -MOANA

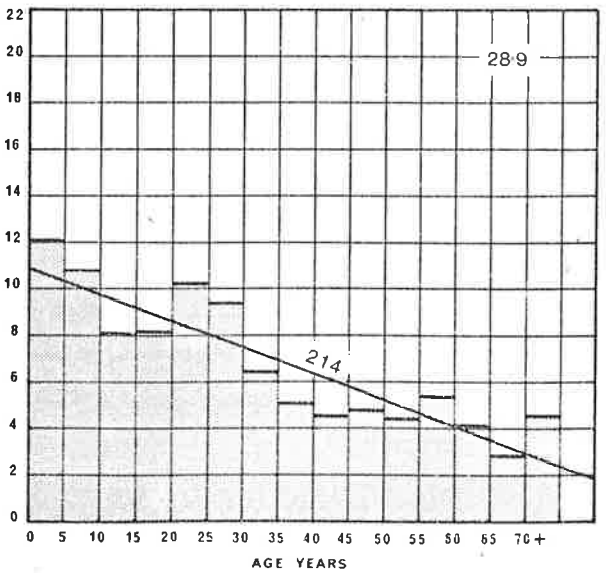

POPULATION AGE STRUCTURES
HISTOGRAMS AND INDICES

S. D. 741 - ELIZABETH

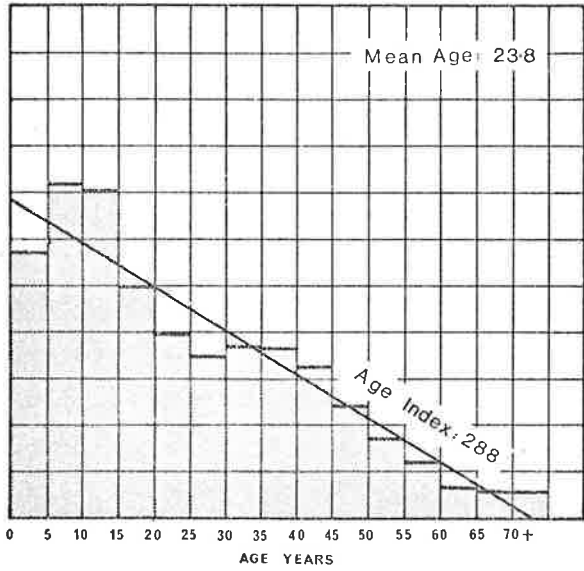

S. D. 742 - FLOREY EAST

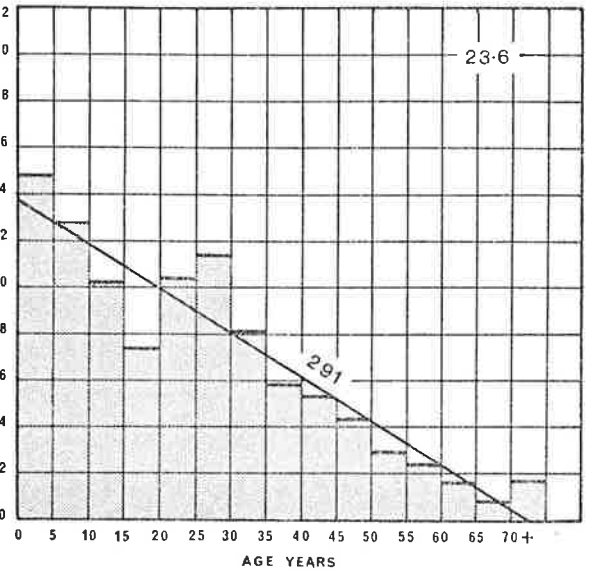

S. D. 743 - MODBURY NORTH

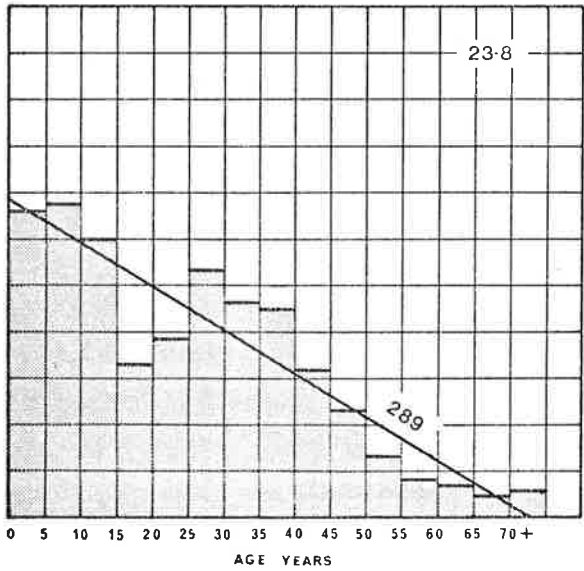

S. D. 744 - PLAYFORD

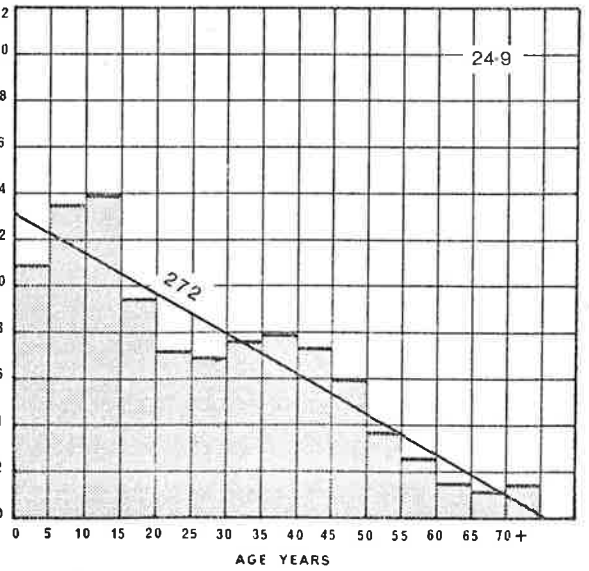

POPULATION AGE STRUCTURES
HISTOGRAMS AND INDICES

S. D. 745 - SALISBURY

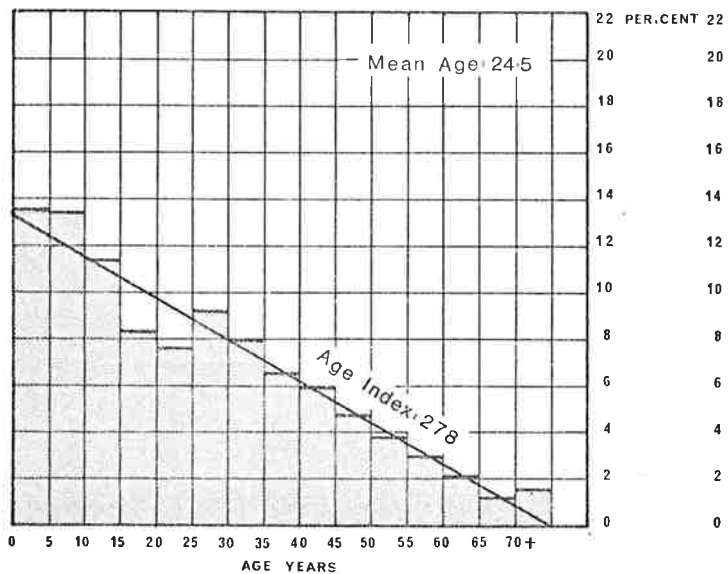

S. D. 751 - BRAGG

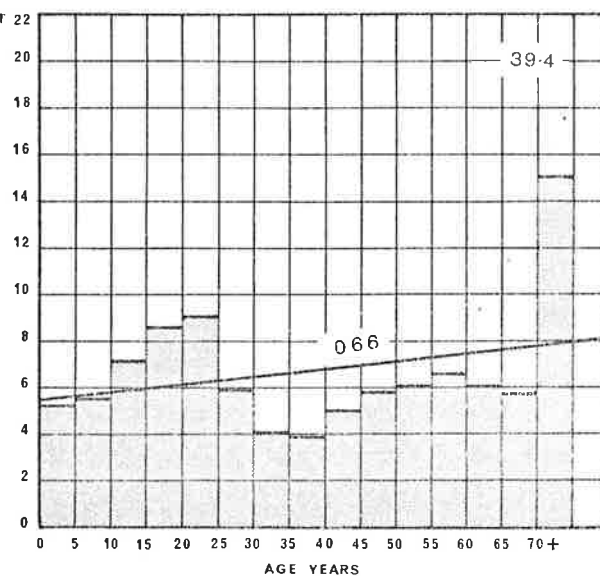

S. D. 752 - FISHER NORTH

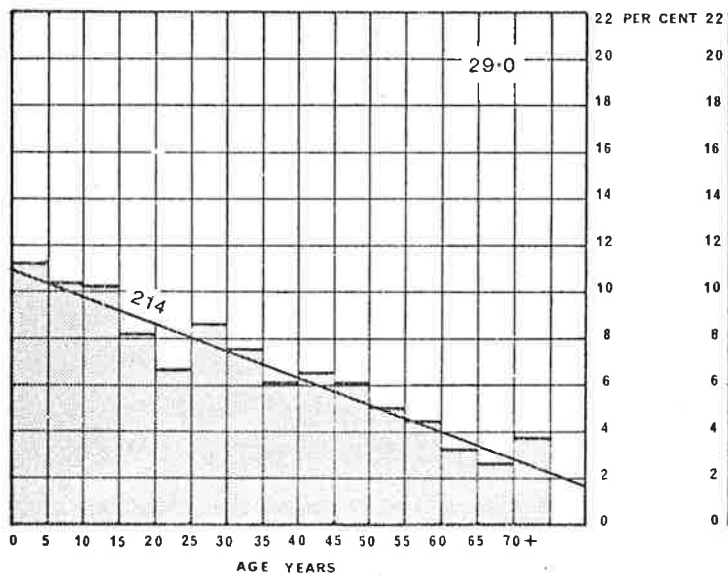

S. D. 753 - LEABROOK

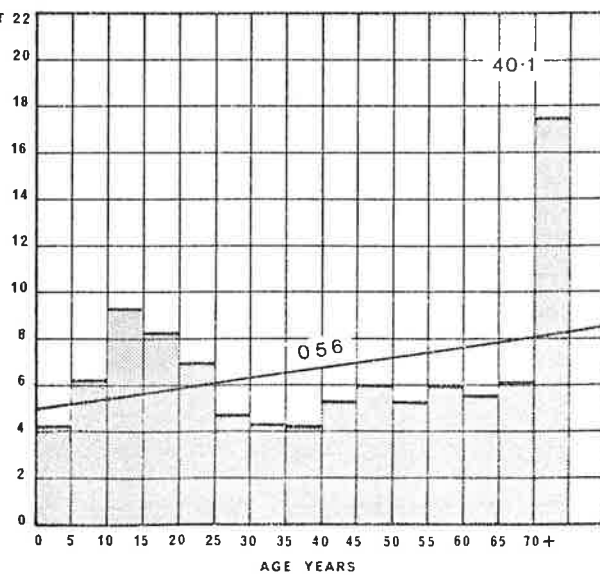

POPULATION AGE STRUCTURES
HISTOGRAMS AND INDICES

S. D. 754 - MITCHAM

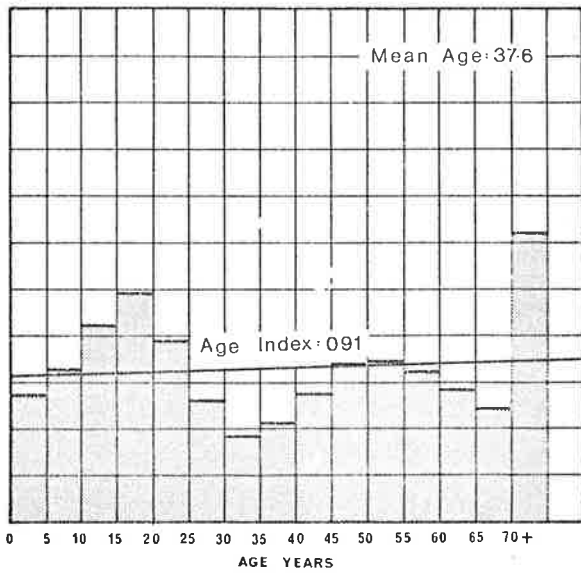

S. D. 755 - NORWOOD

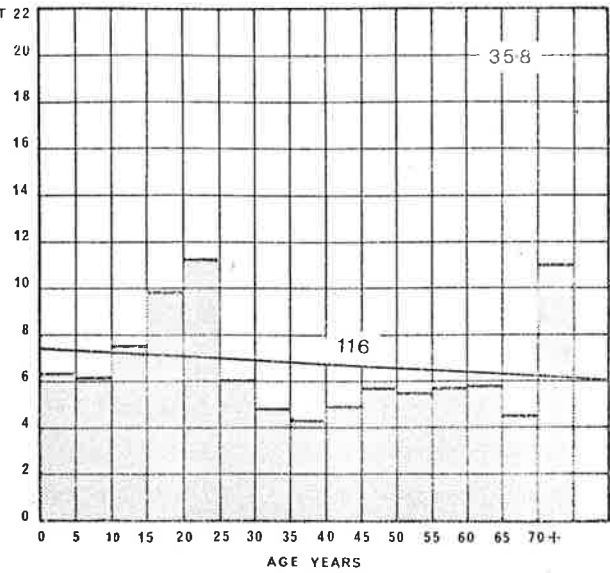

S. D. 756 - UNLEY

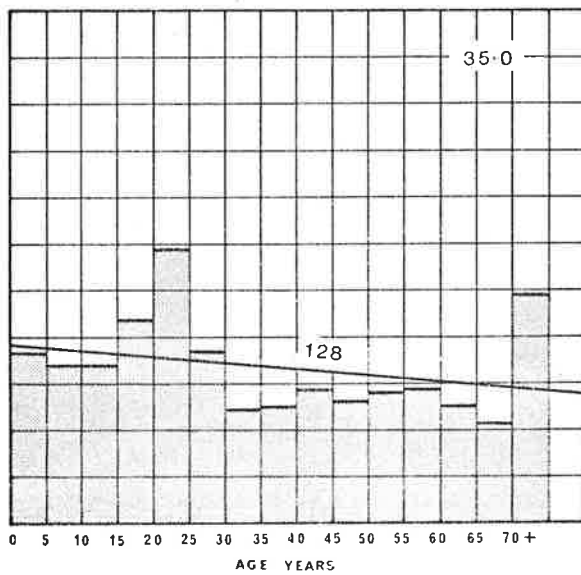

S. D. 771 - ASCOT PARK

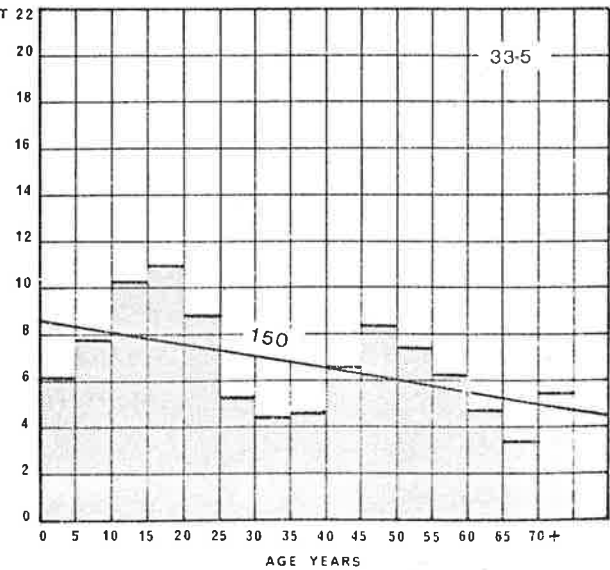

POPULATION AGE STRUCTURES
HISTOGRAMS AND INDICES

S. D.772--FISHER WEST

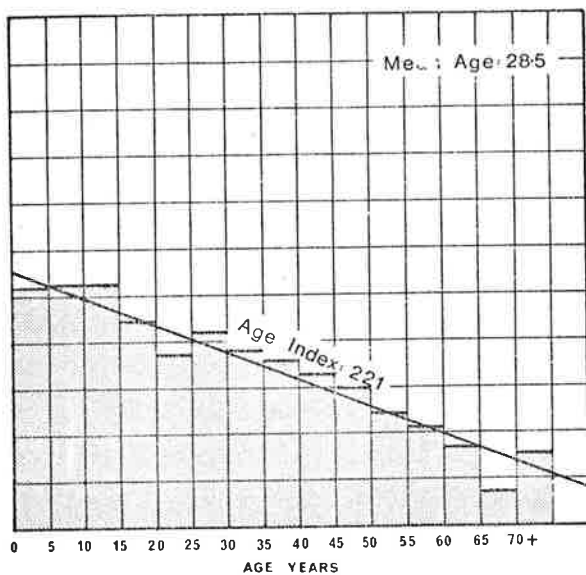

S. D.773--GOODWOOD

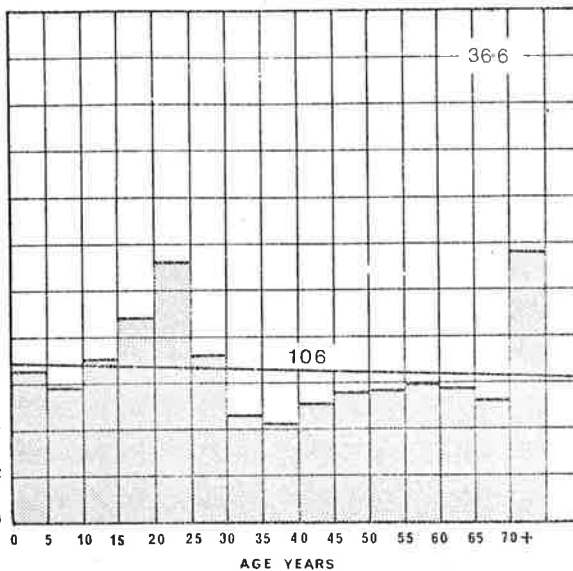

S. D.774--HANSON EAST

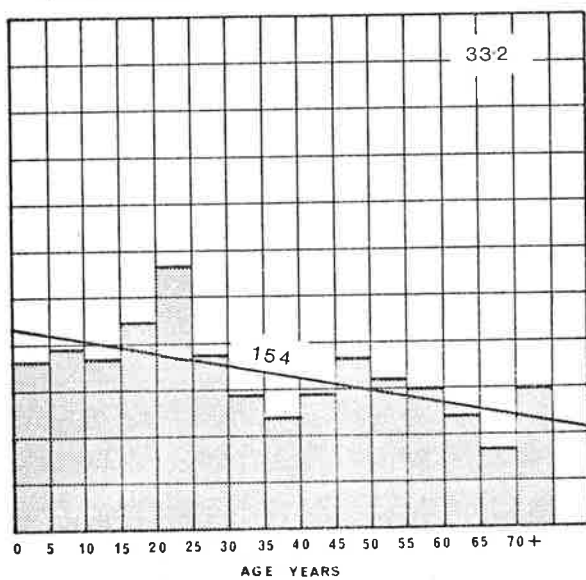

S. D.775--MARLESTON

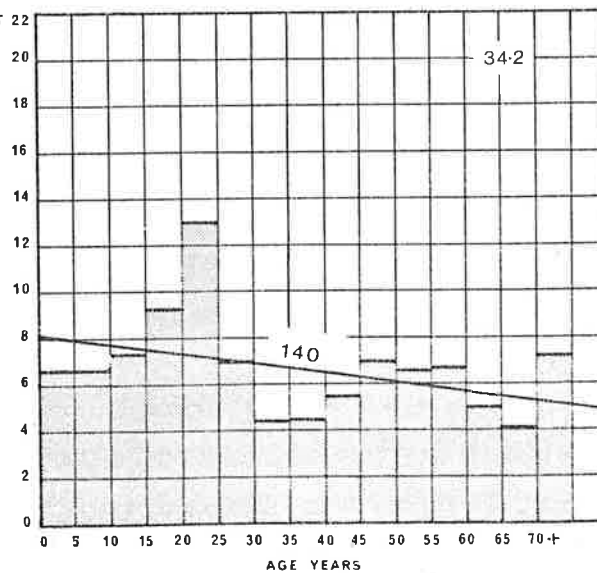

POPULATION AGE STRUCTURES
HISTOGRAMS AND INDICES

S. D.776 · MITCHELL

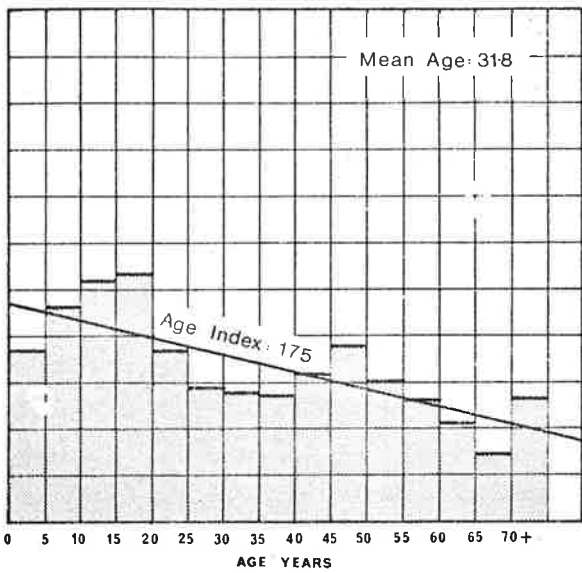

S. D.781 · BEVERLEY

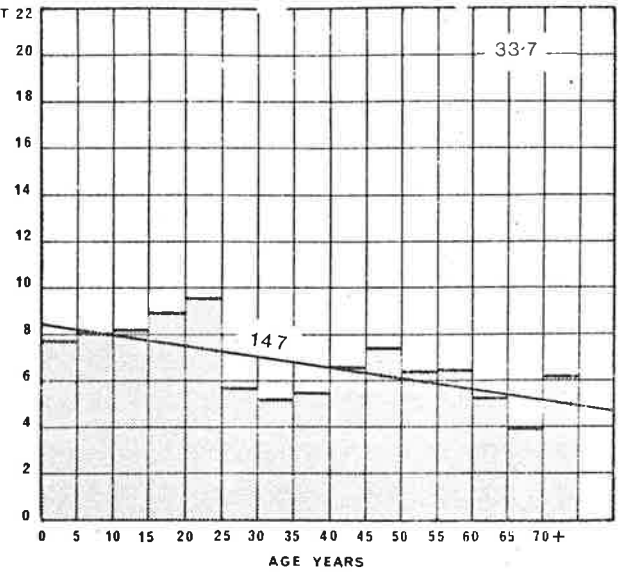

S. D.782 · HANSON NORTH

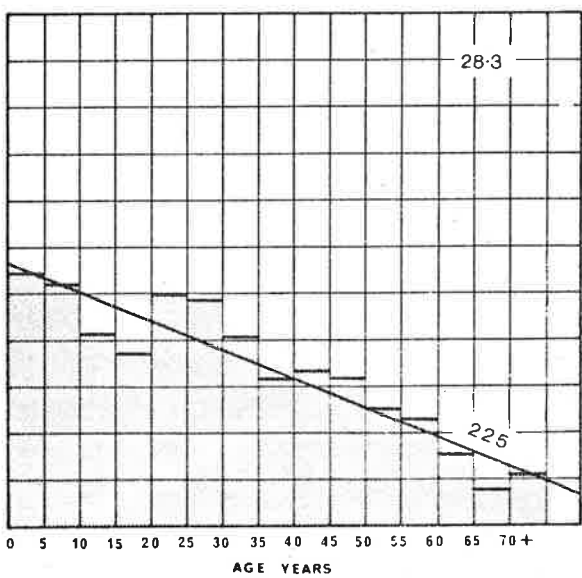

S. D.783 · HENLEY BEACH

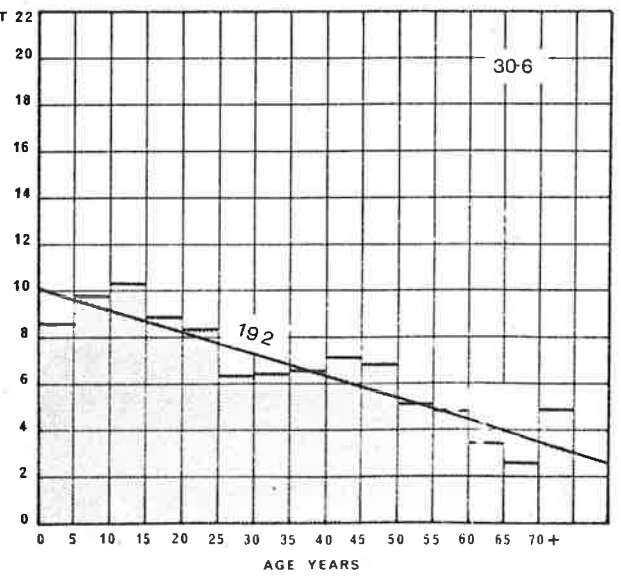

POPULATION AGE STRUCTURES
HISTOGRAMS AND INDICES

S. D. 784 - PEAKE

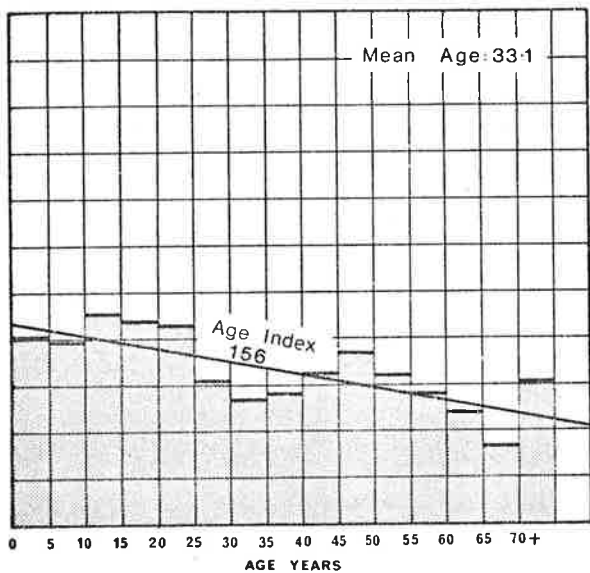

S. D. 785 - SPENCE SOUTH

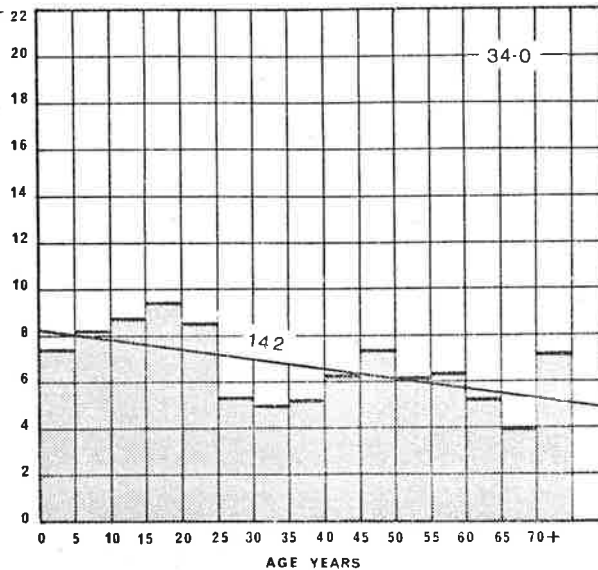

S. D. 786 - THEBARTON

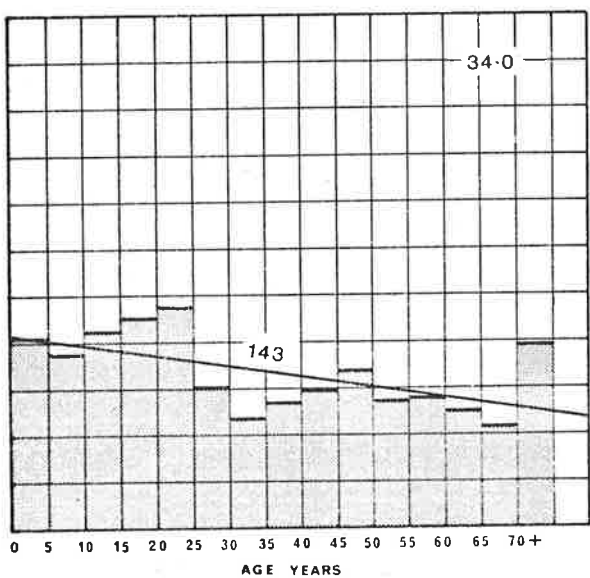

S. D. 791 - BRIGHTON

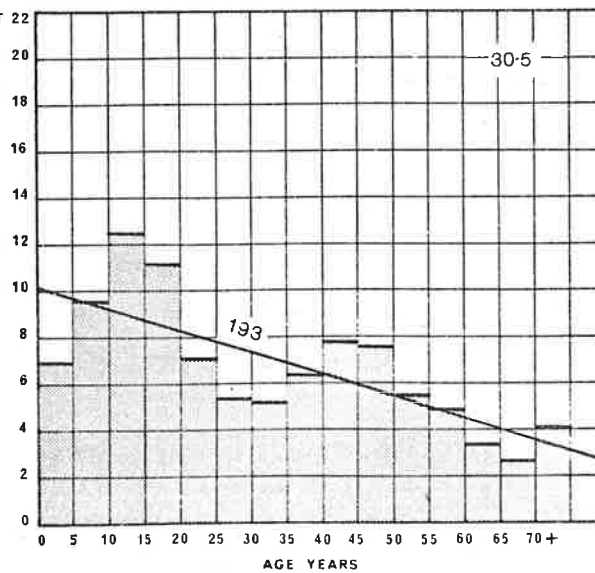

POPULATION AGE STRUCTURES
HISTOGRAMS AND INDICES

S. D. 792 - GLENELG

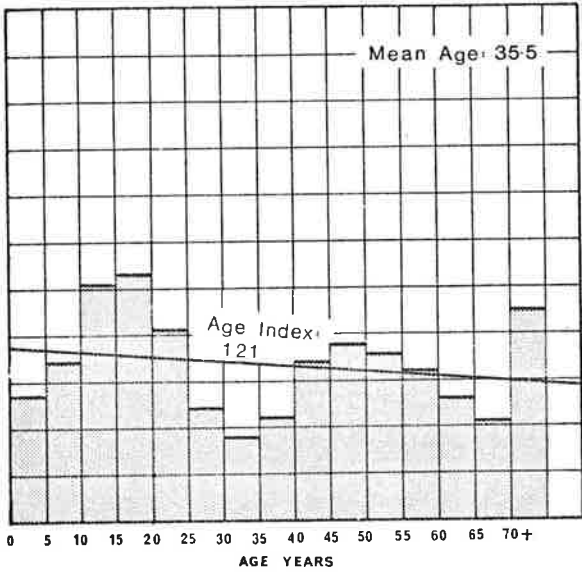

S. D. 793 - HANSON SOUTH

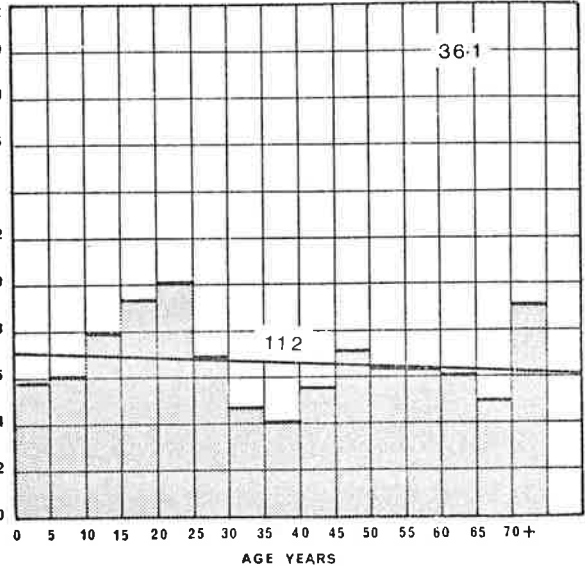

S. D. 794 - MAWSON

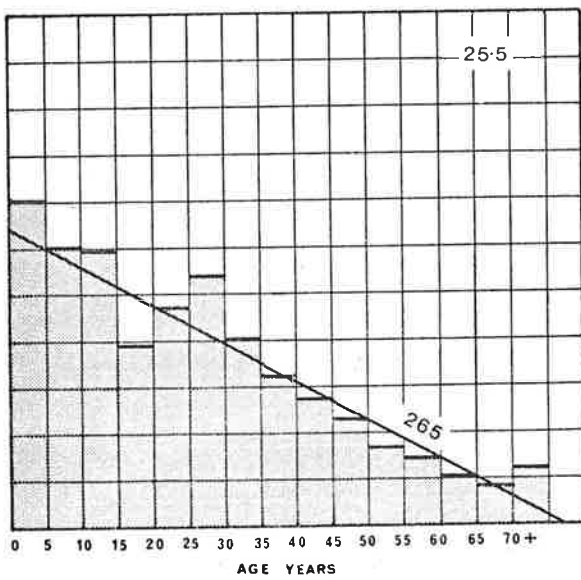

S. D. 801 - ALBERT PARK

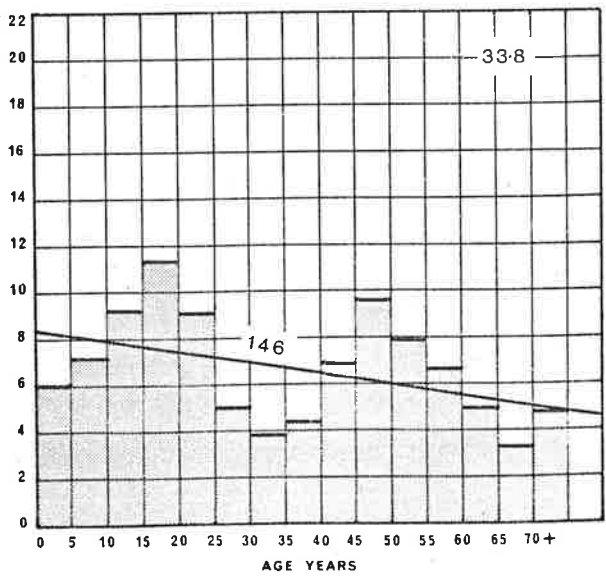

POPULATION AGE STRUCTURES
HISTOGRAMS AND INDICES

S. D. 802 - ANGLE PARK

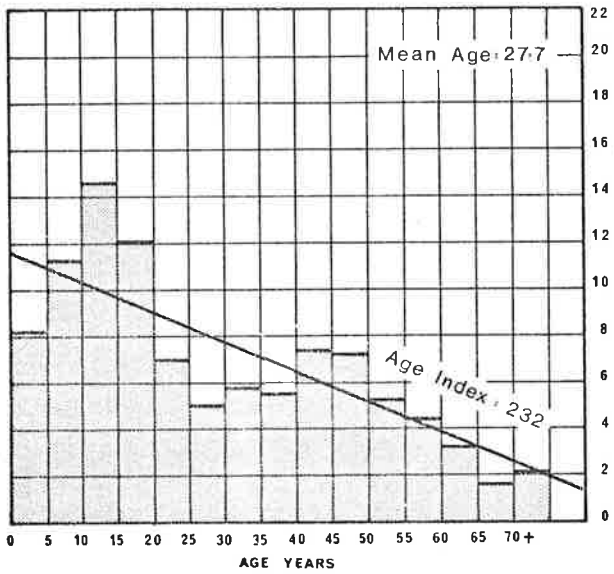

S. D. 803 - PRICE

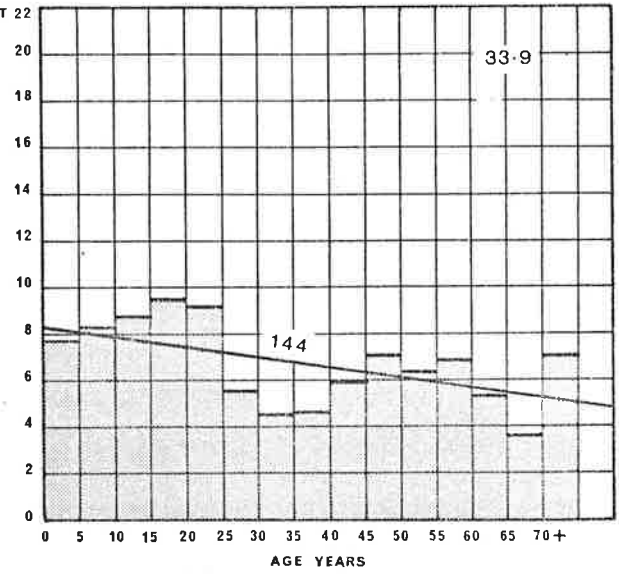

S. D. 804 - SEMAPHORE

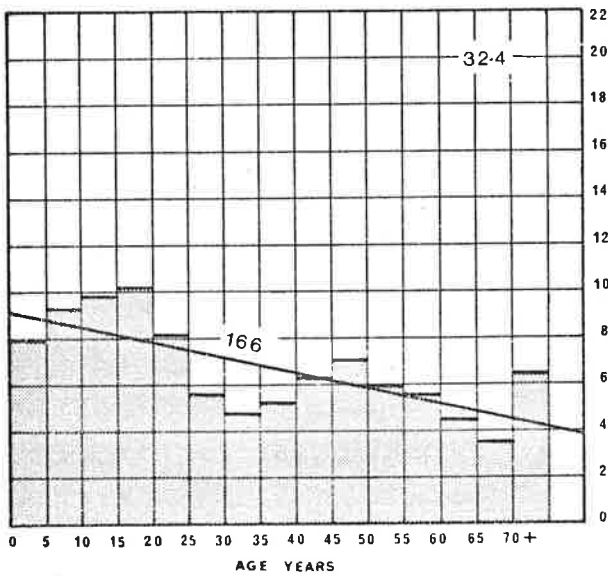

S. D. 805 - SPENCE NORTH

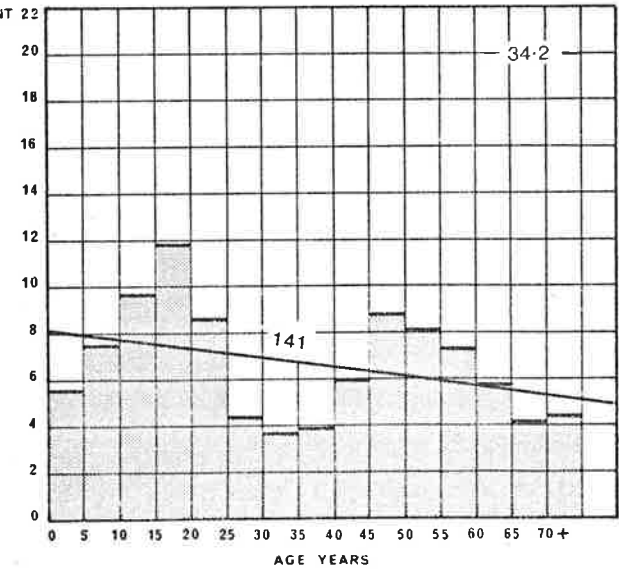

POPULATION AGE STRUCTURES
HISTOGRAMS AND INDICES

S. D. 811 - COLES

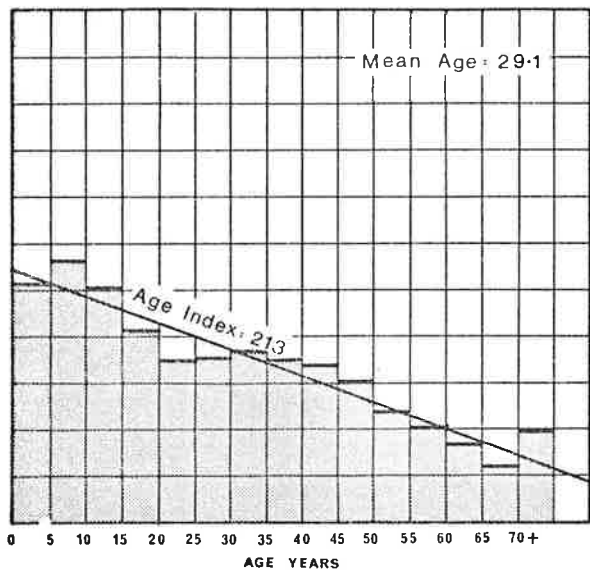

S. D. 812 - DAVENPORT

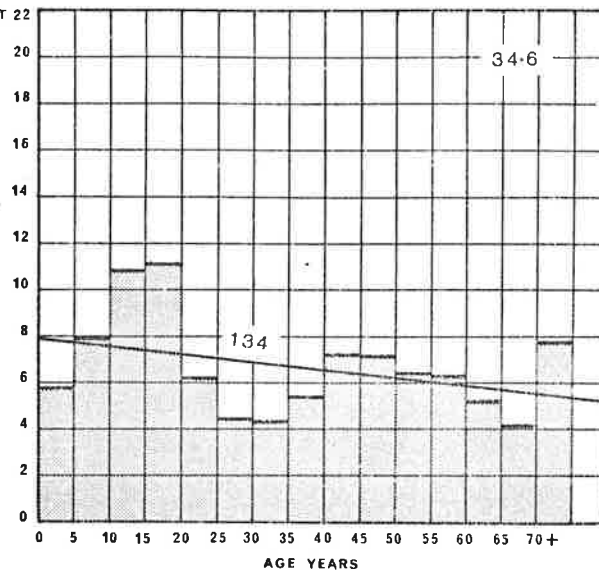

S. D. 813 - GILLES EAST

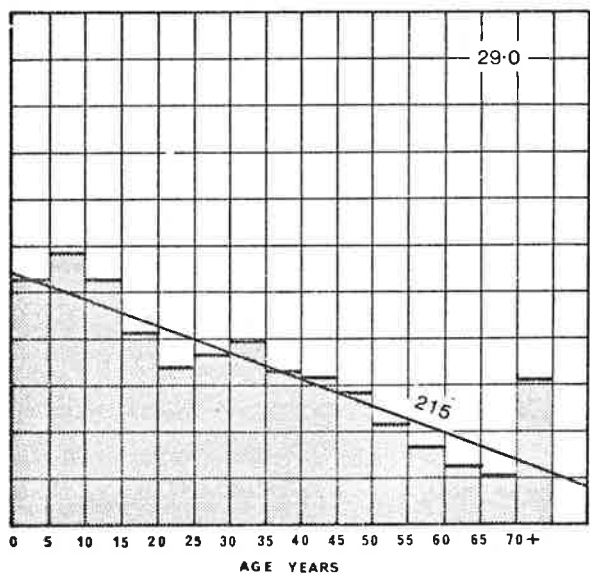

S. D. 814 - HIGHBURY

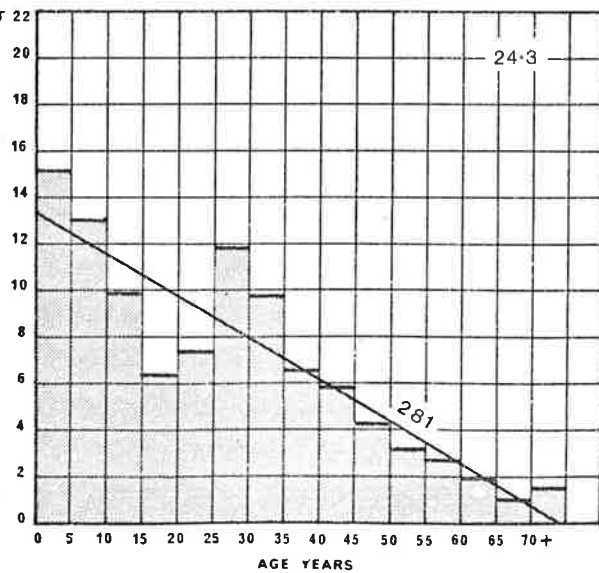

POPULATION AGE STRUCTURES
HISTOGRAMS AND INDICES

S. D. 823 - GOYDER (PT)

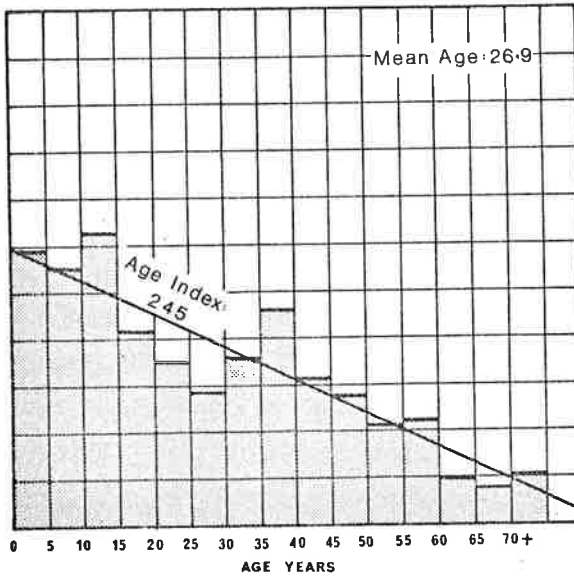

S. D. 824 - LIGHT NORTH (PT)

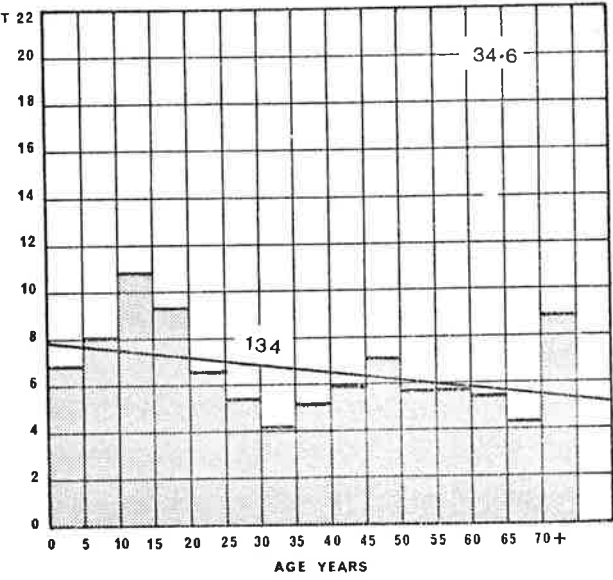

APPENDIX D

Polar graphs for each electoral subdivision within the Adelaide Statistical Division showing the volume, distance and direction of intra-urban migrations.

Source: Author's reprocessing of data for period 12 March 1970 to 11 June 1971 supplied by the State Electoral Department, Adelaide.

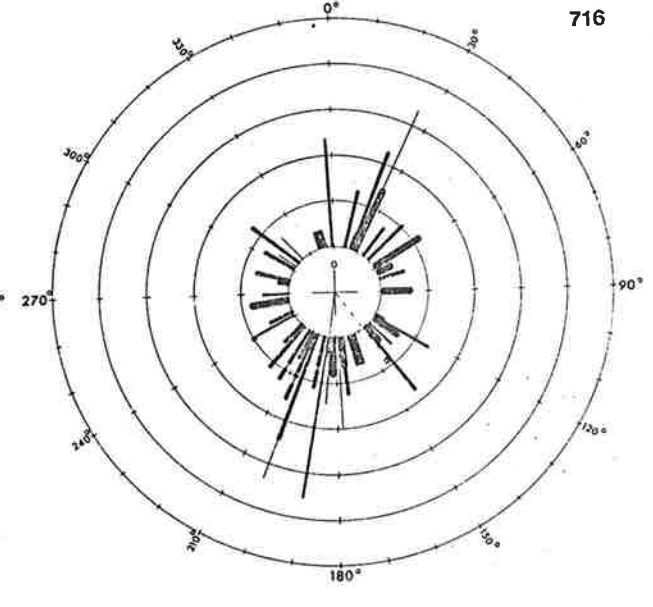
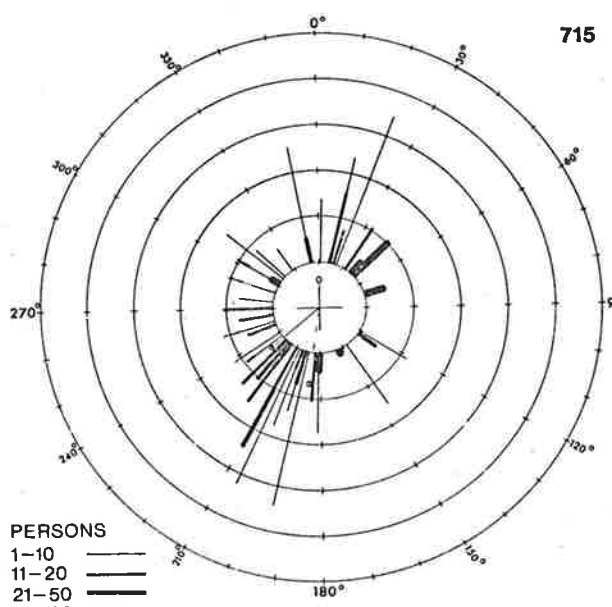
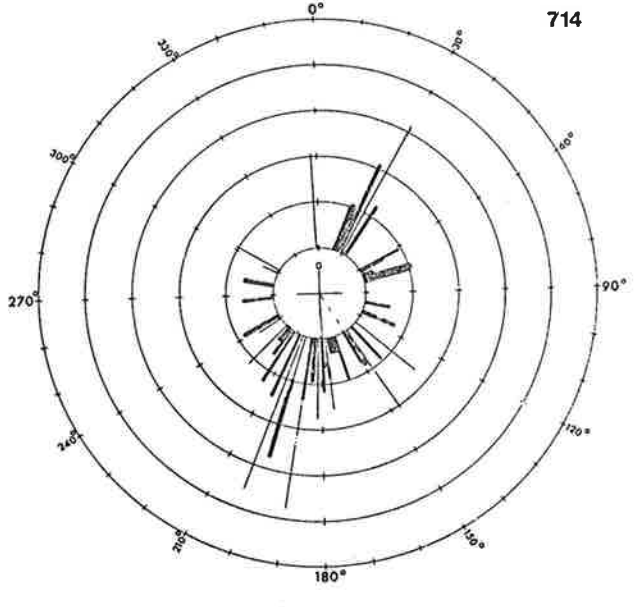
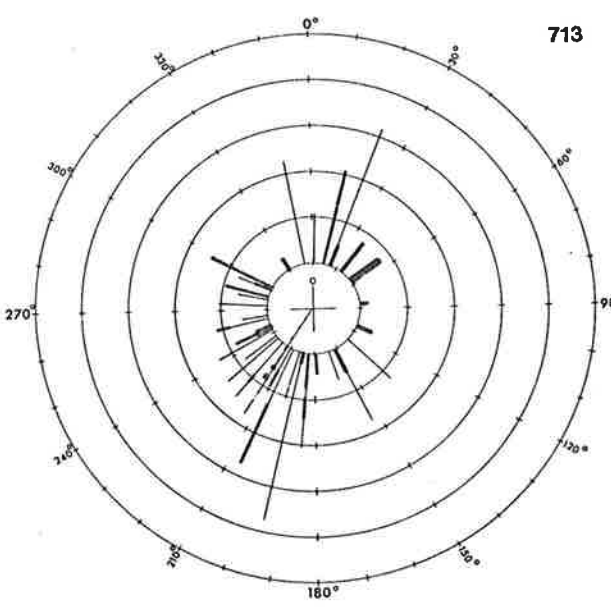
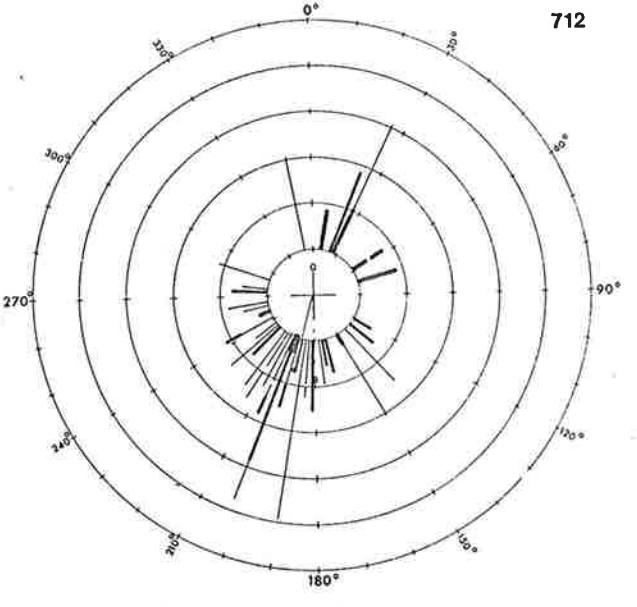
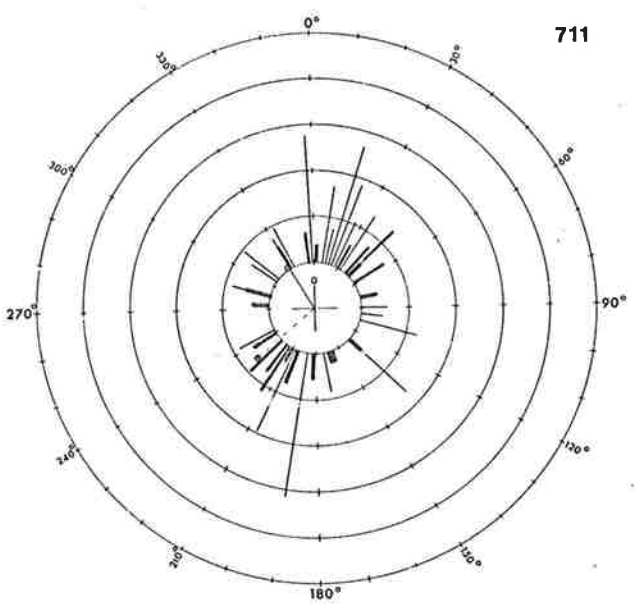

PERSONS
 1-10 ———
 11-20 ———
 21-50 ———
 51-99 ———
 100+ ———

-----■ Mean Distance Dominant Direction
 ———● Distance & Direction to C.B.D.

DISTANCES
 Radial intervals — 10 km
 Inner circle = 0

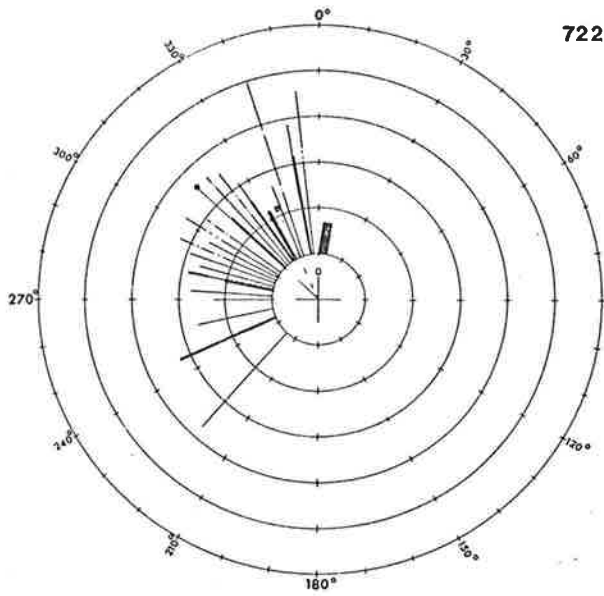

722

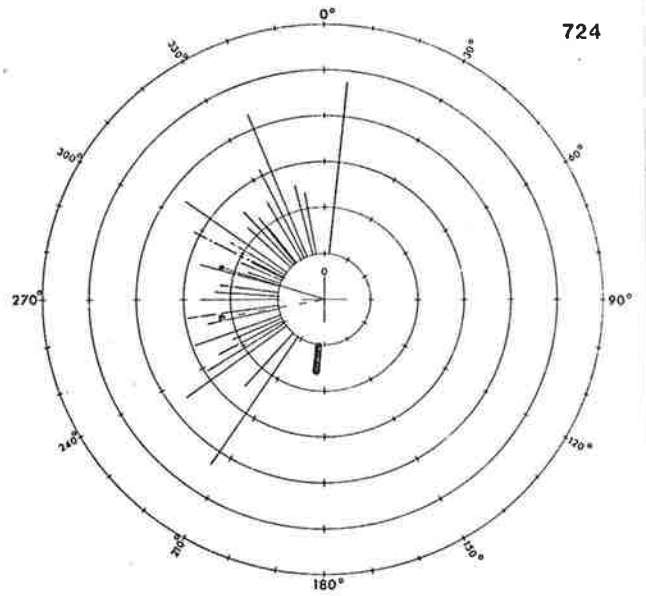

724

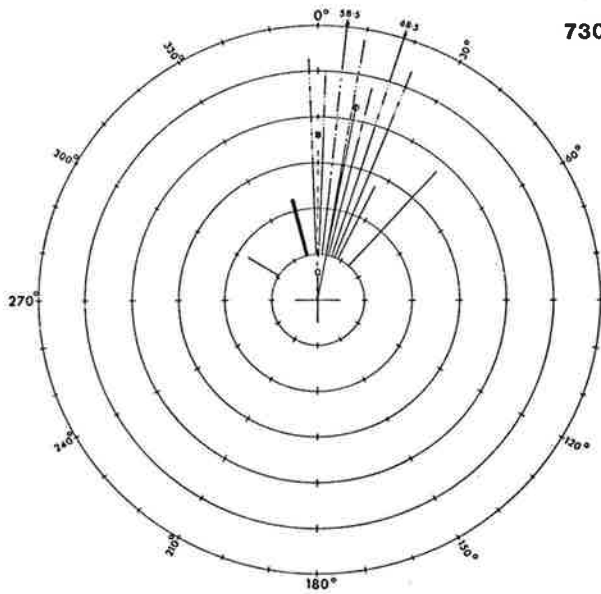

730

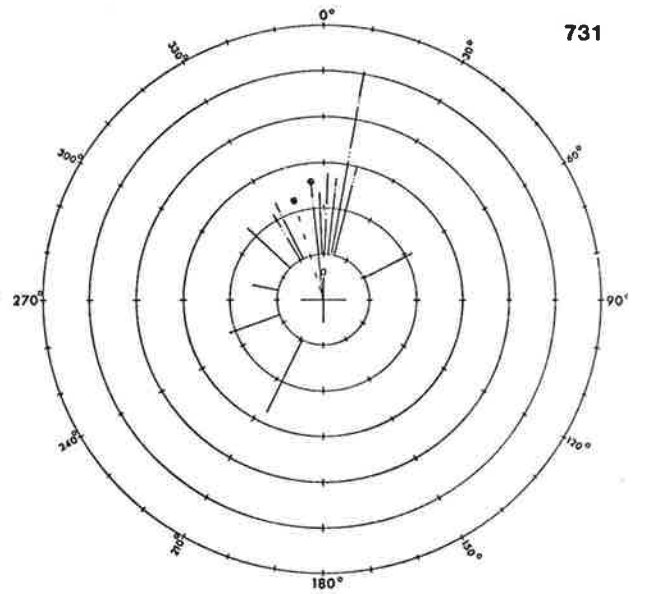

731

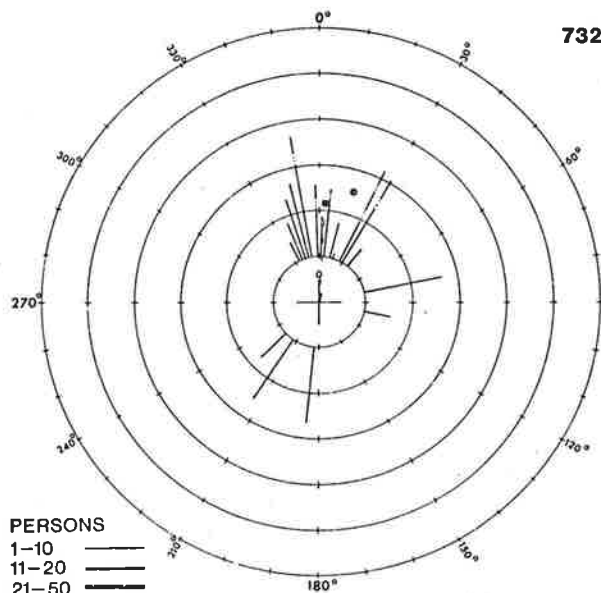

732

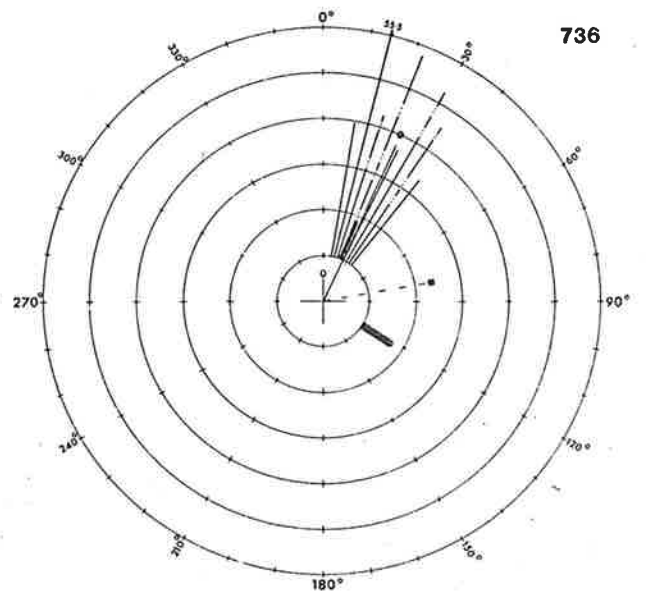

736

PERSONS
 1-10 ———
 11-20 ———
 21-50 ———
 51-99 ———
 100+ ———
 - - - - - Mean Distance Dominant Direction
 ——— Distance & Direction to C.B.D.

DISTANCES
 Radial intervals — 10 km
 Inner circle = 0

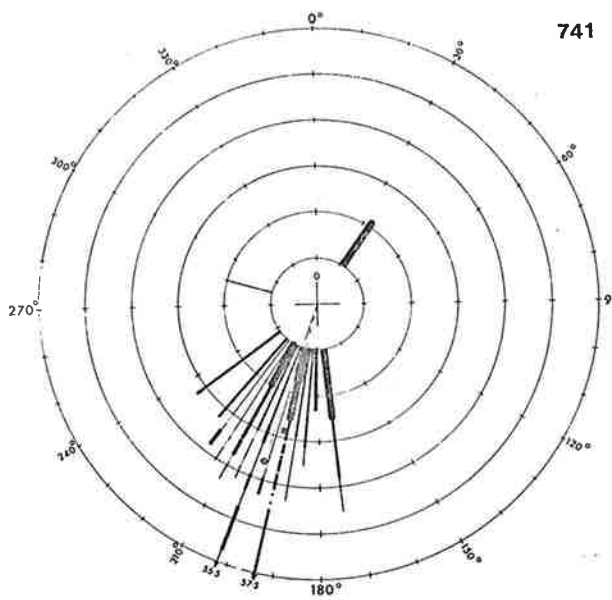

741

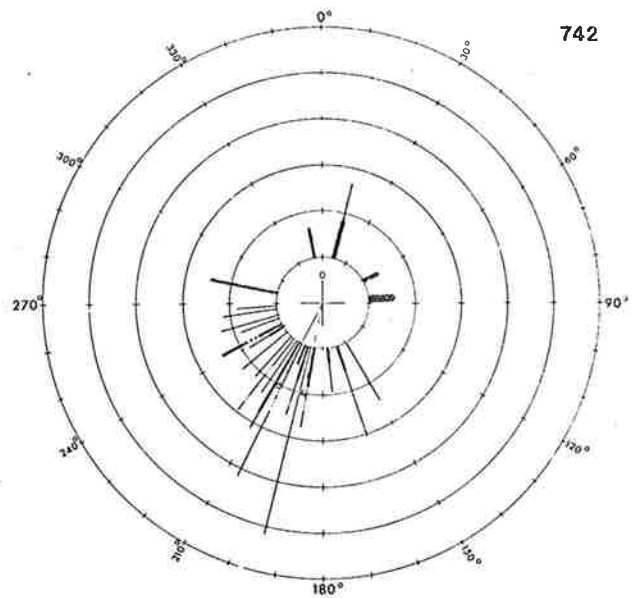

742

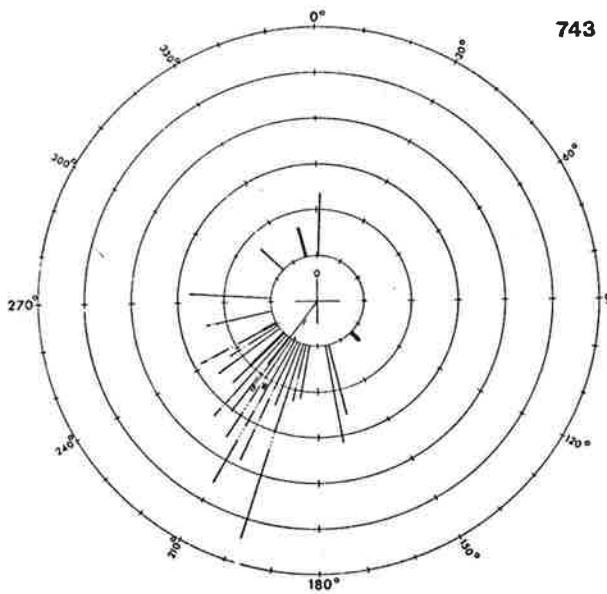

743

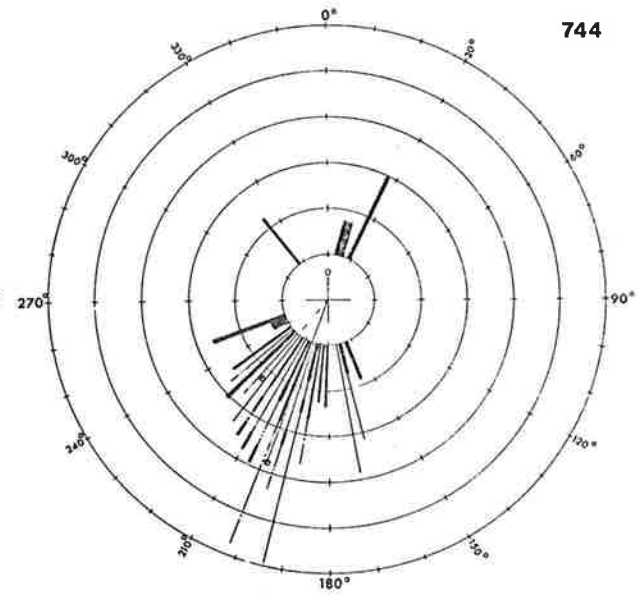

744

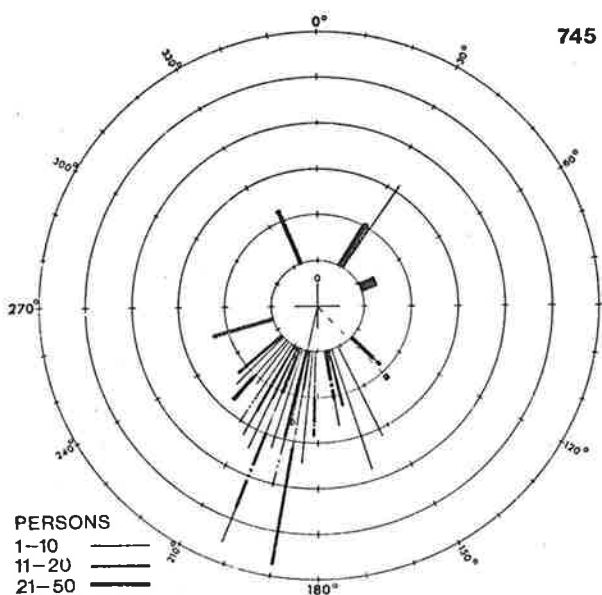

745

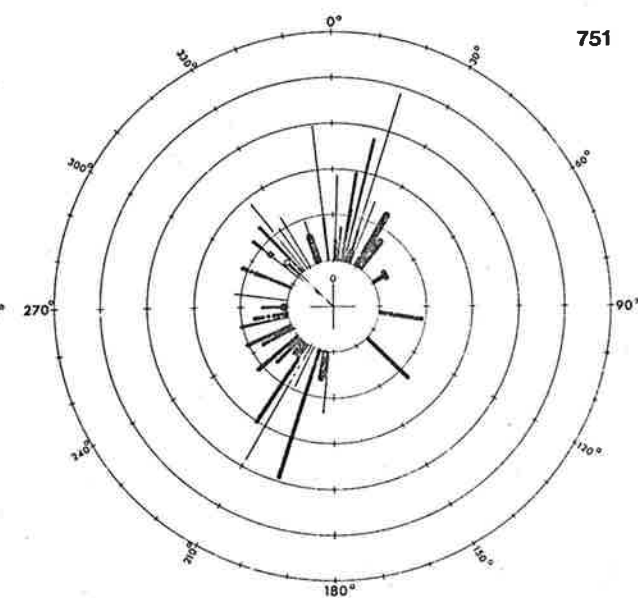

751

PERSONS

- 1-10
- 11-20
- 21-50
- 51-99
- 100+

- Mean Distance Dominant Direction
- Distance & Direction to C.B.D.

DISTANCES
 Radial intervals—10 km
 Inner circle = 0

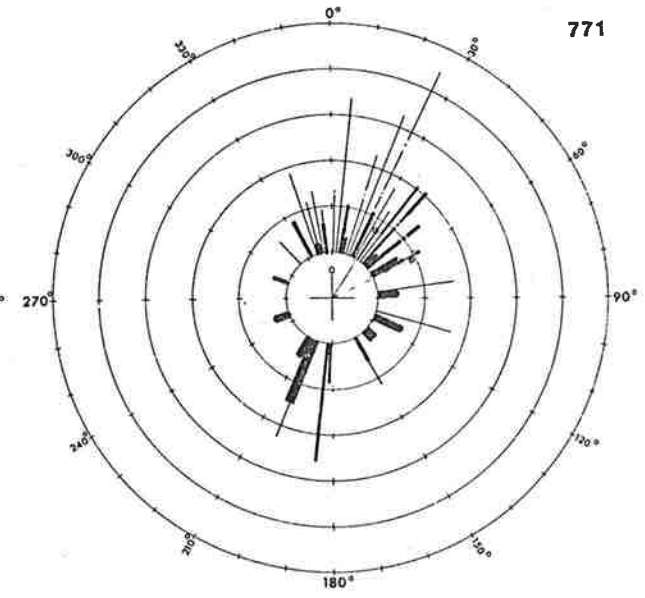
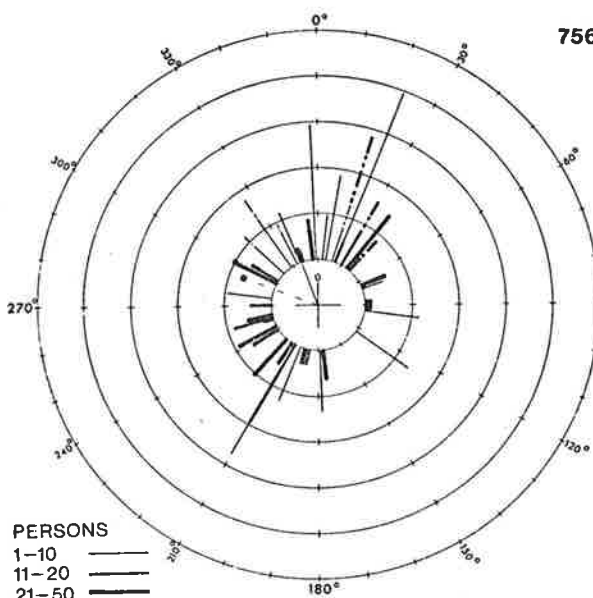
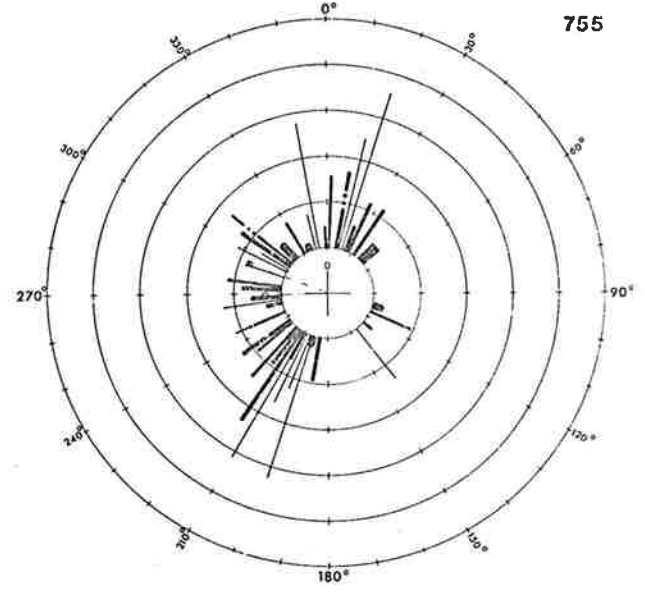
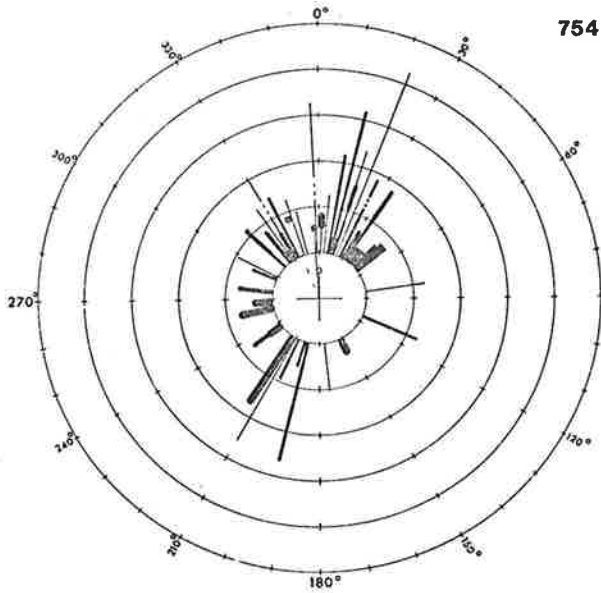
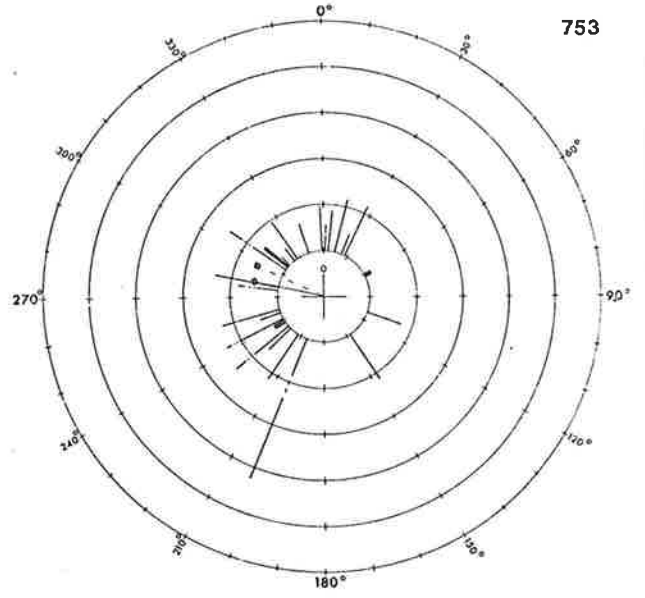
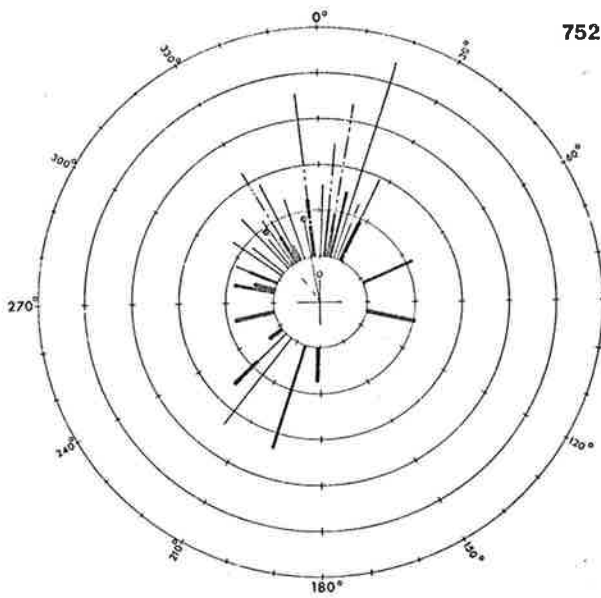

PERSONS
 1-10 ———
 11-20 ———
 21-50 ———
 51-99 ———
 100+ ———

----- Mean Distance Dominant Direction
 ———● Distance & Direction to C.B.D.

DISTANCES
 Radial intervals — 10 km
 Inner circle = 0

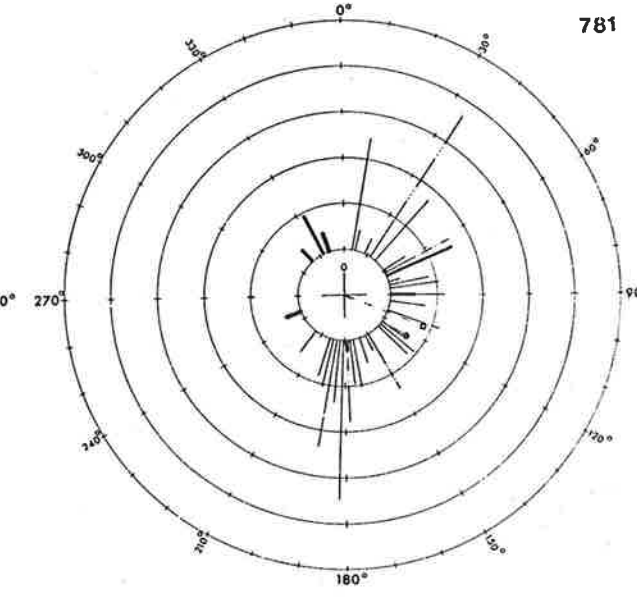
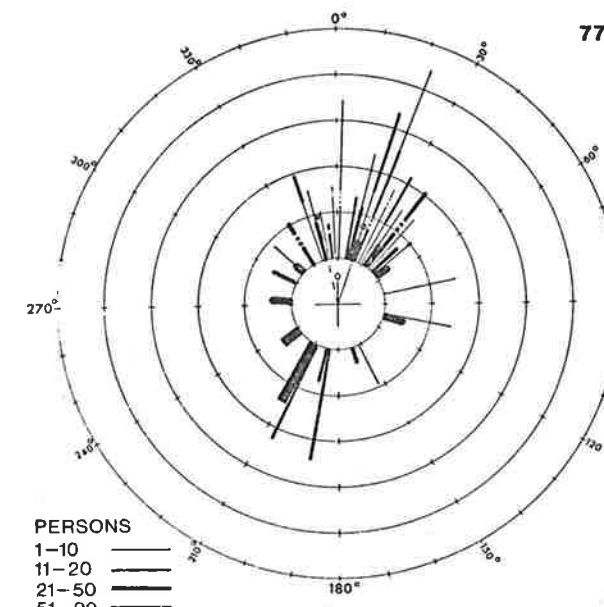
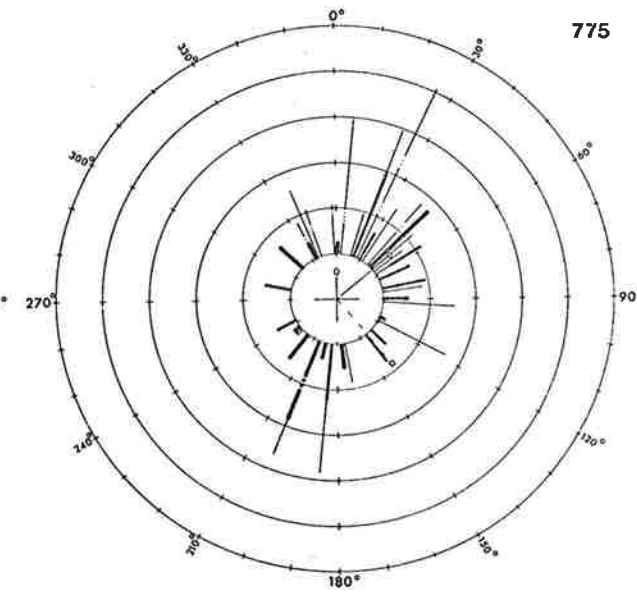
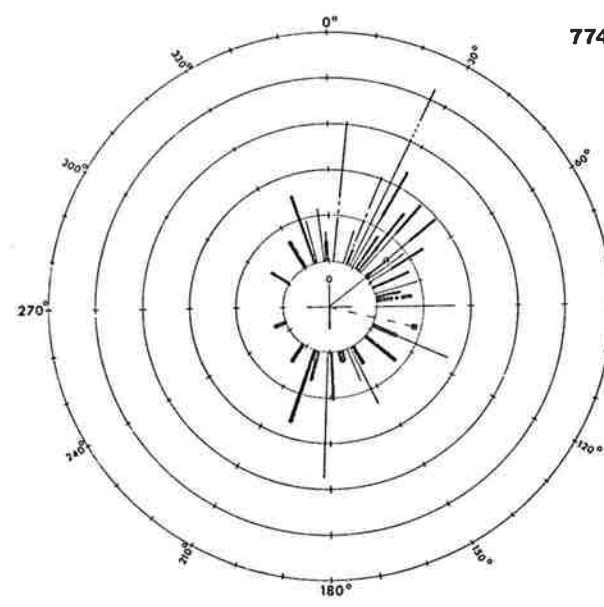
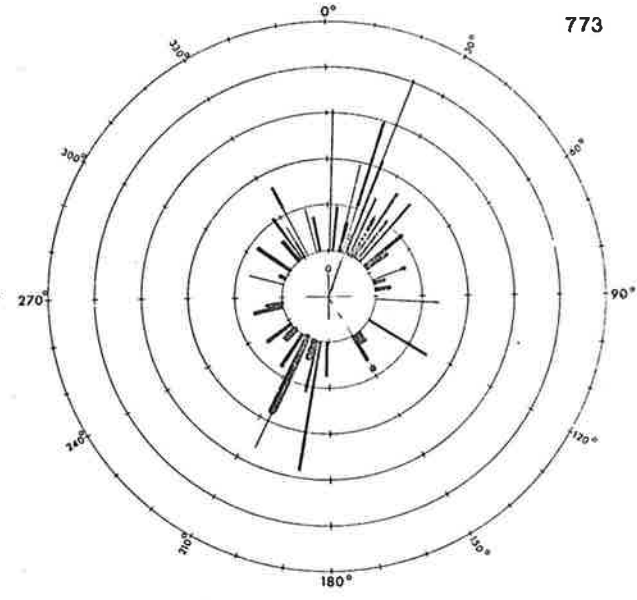
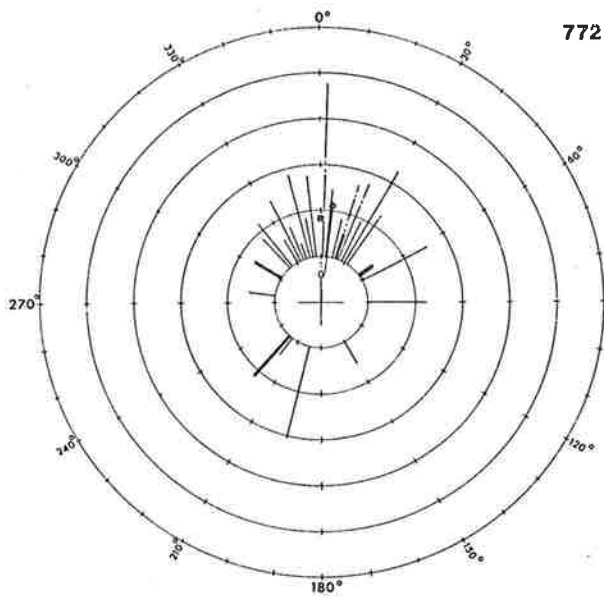

PERSONS

- 1-10
- 11-20
- 21-50
- 51-99
- 100+

-----□ Mean Distance Dominant Direction
 -----○ Distance & Direction to C.B.D.

DISTANCES

Radial intervals - 10 km
 Inner circle = 0

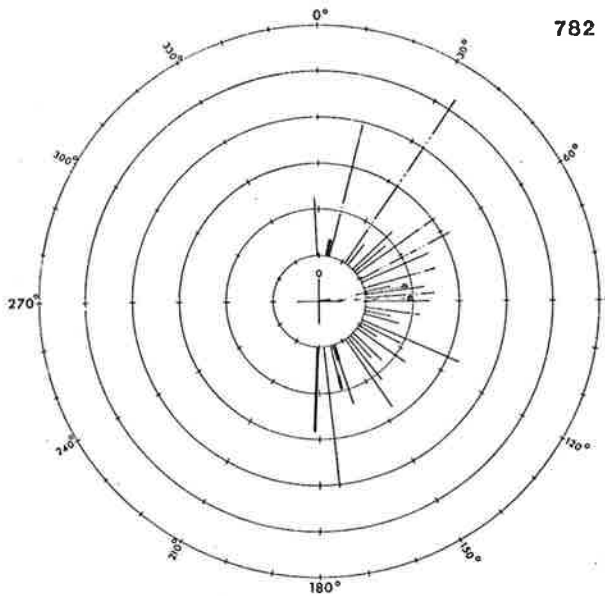

782

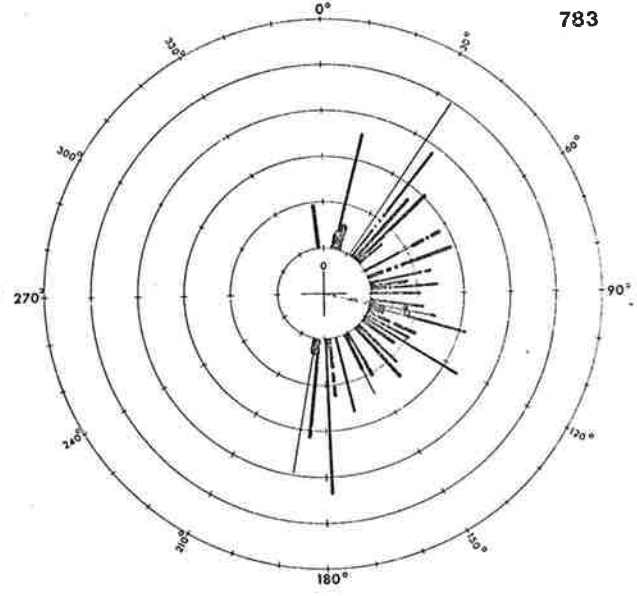

783

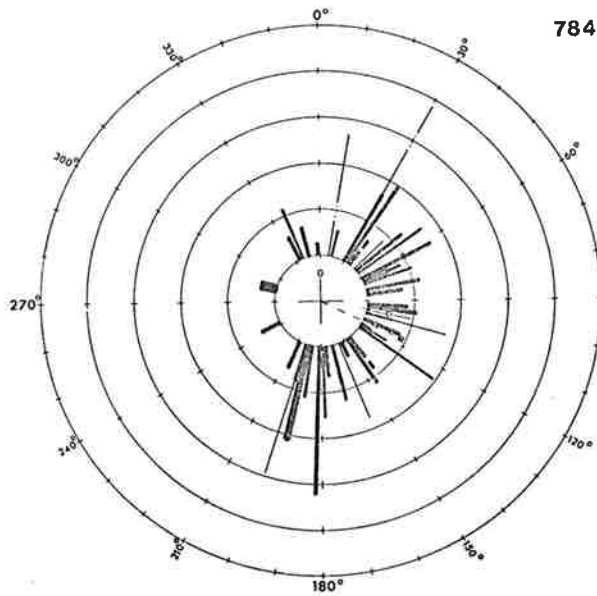

784

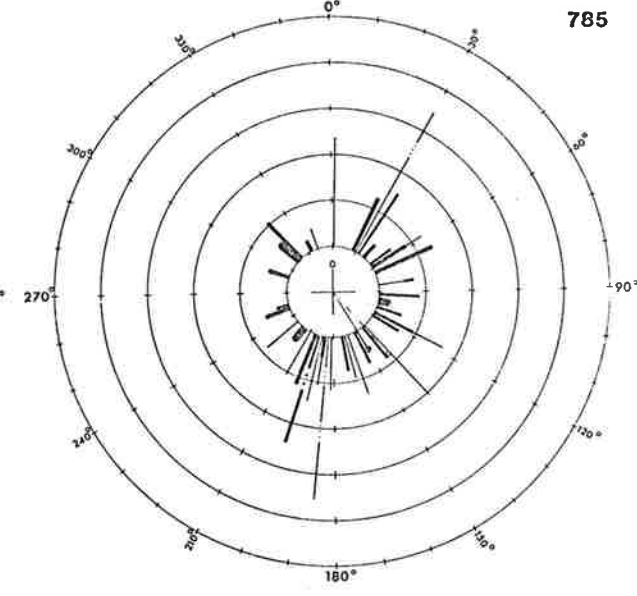

785

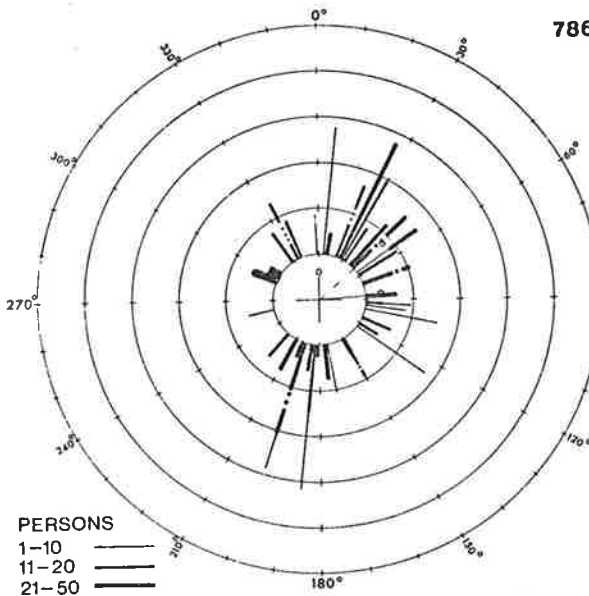

786

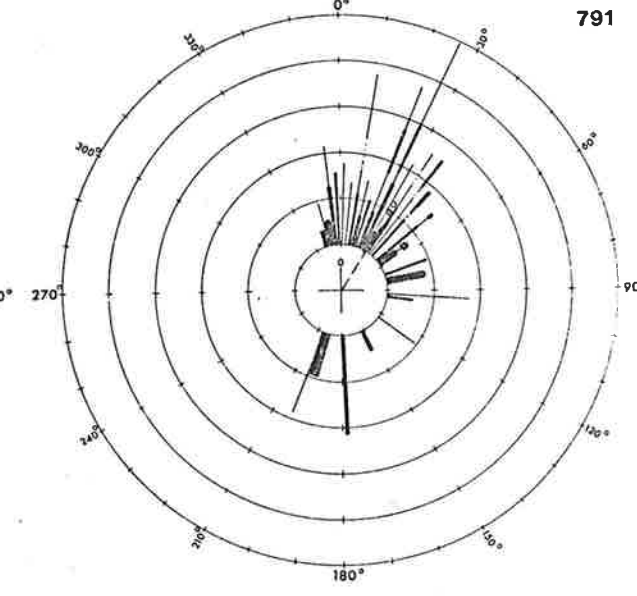

791

PERSONS
 1-10 ———
 11-20 ———
 21-50 ———
 51-99 ———
 100+ ———
 - - - - - Mean Distance Dominant Direction
 ——— Distance & Direction to C.B.D.

DISTANCES
 Radial intervals - 10 km
 Inner circle = 0

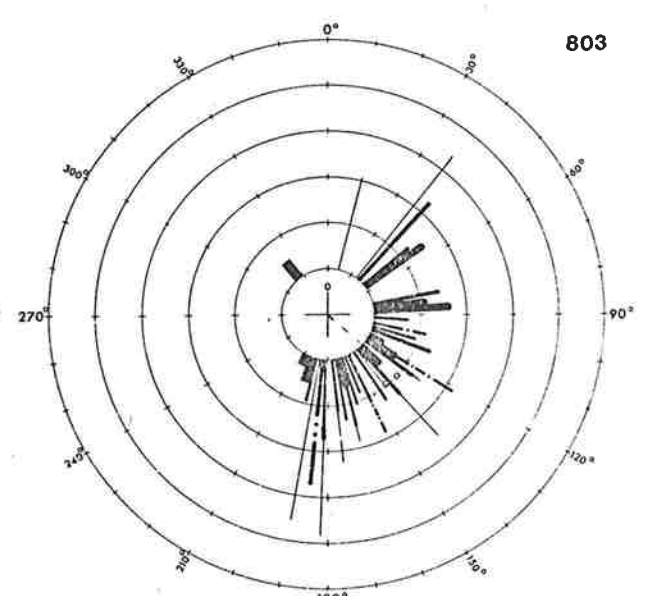
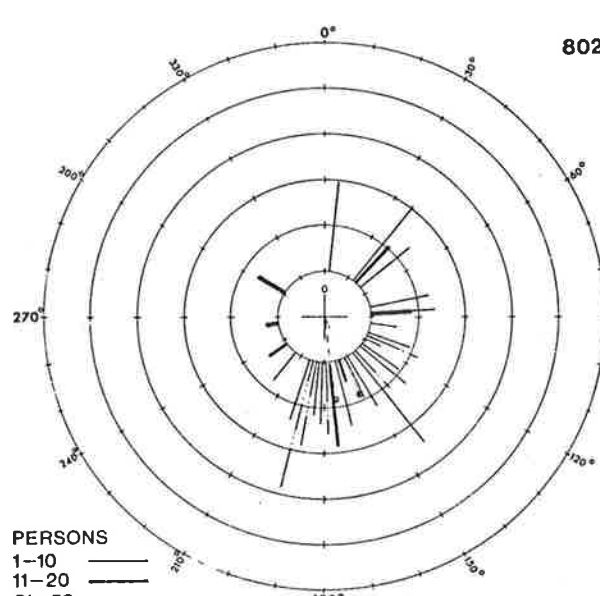
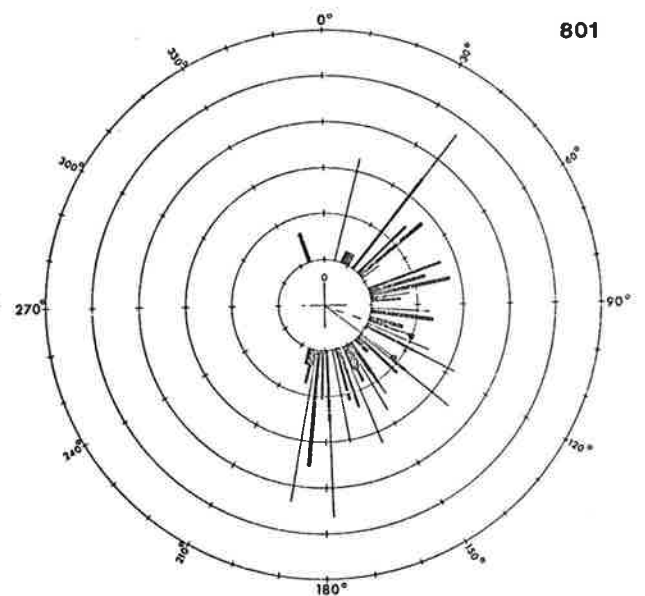
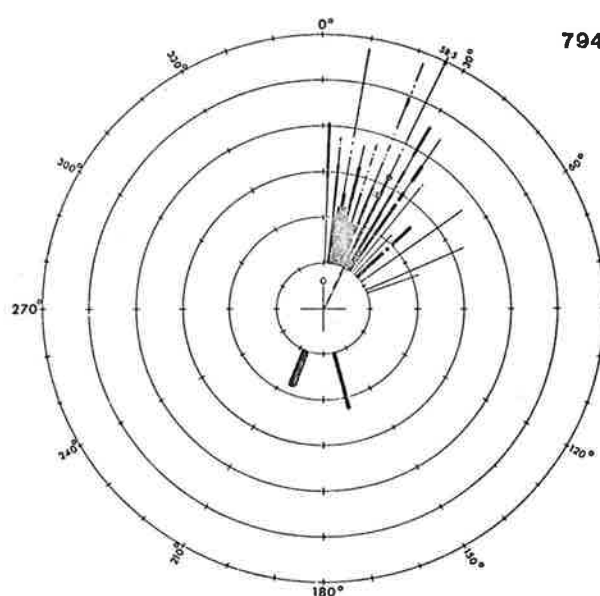
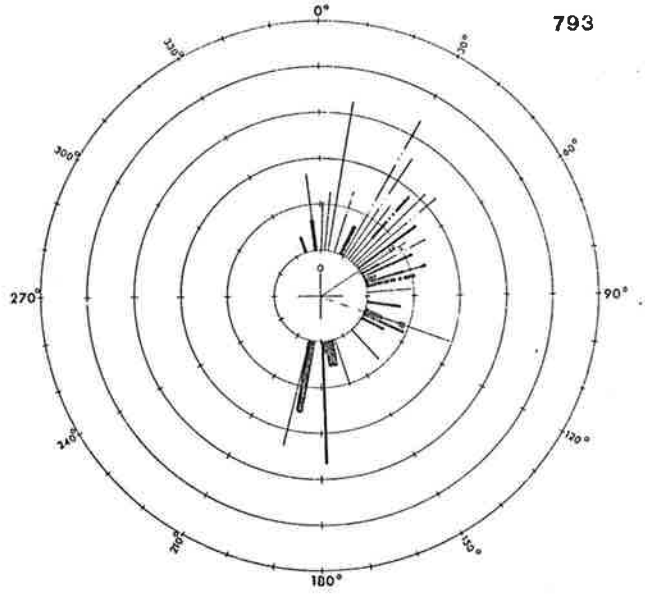
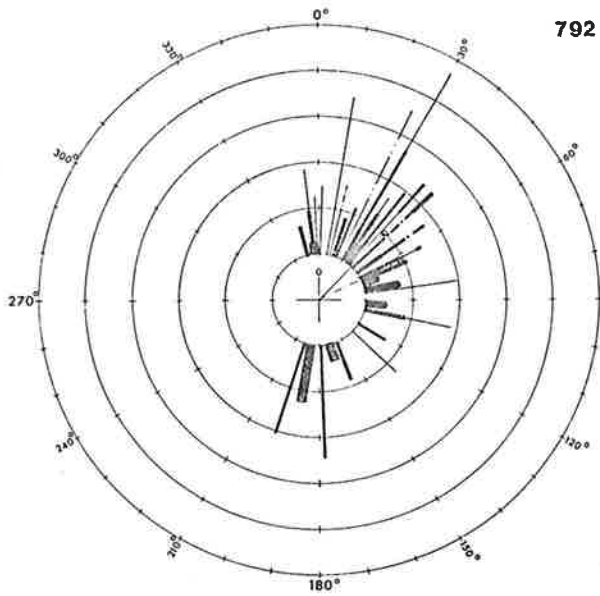

PERSONS
 1-10 ———
 11-20 ———
 21-50 ———
 51-99 ———
 100+ ———

----- Mean Distance Dominant Direction
 ——— Distance & Direction to C.B.D.

DISTANCES
 Radial intervals—10 km
 Inner circle = 0

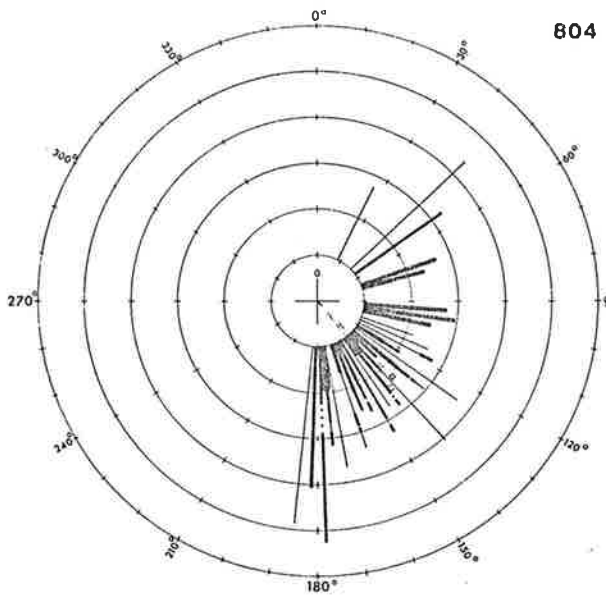

804

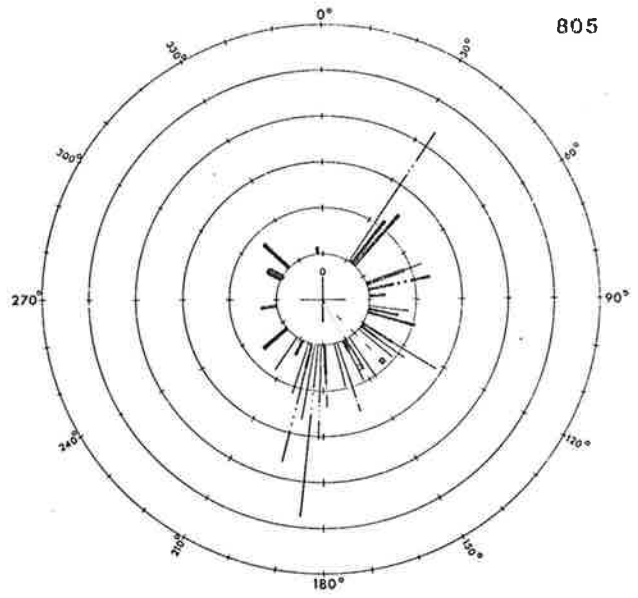

805

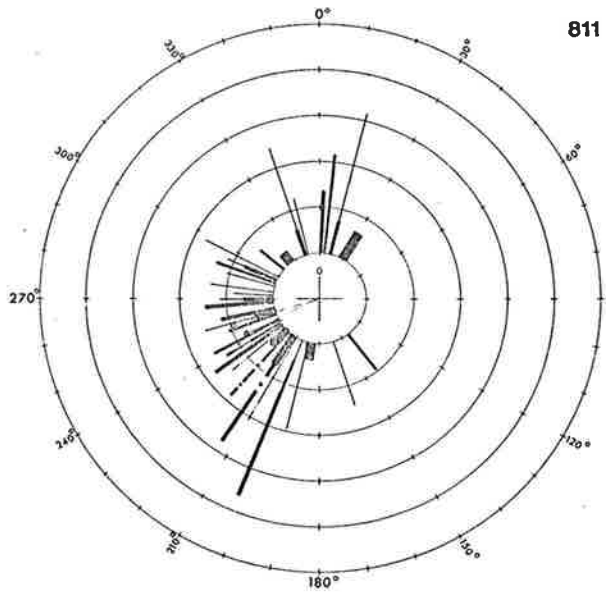

811

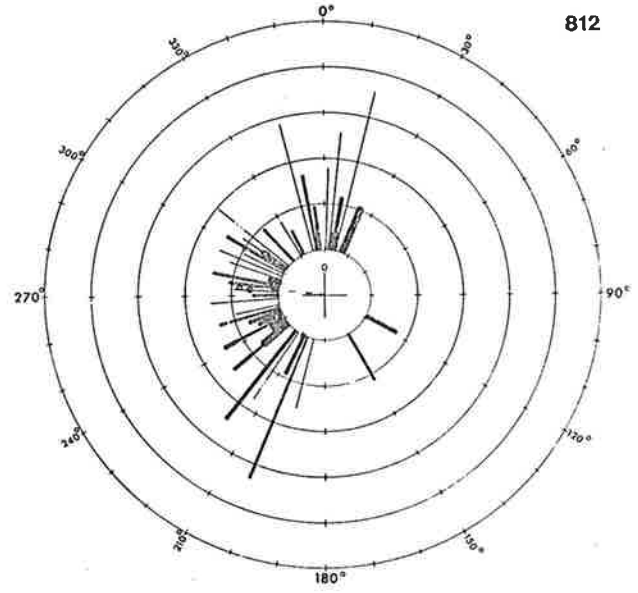

812

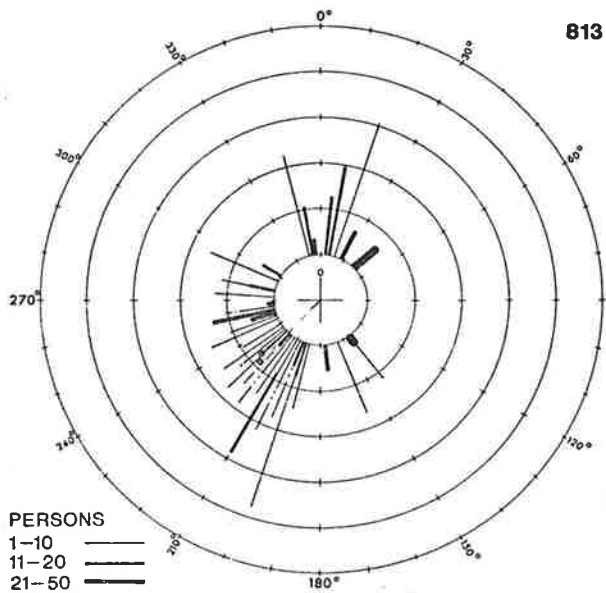

813

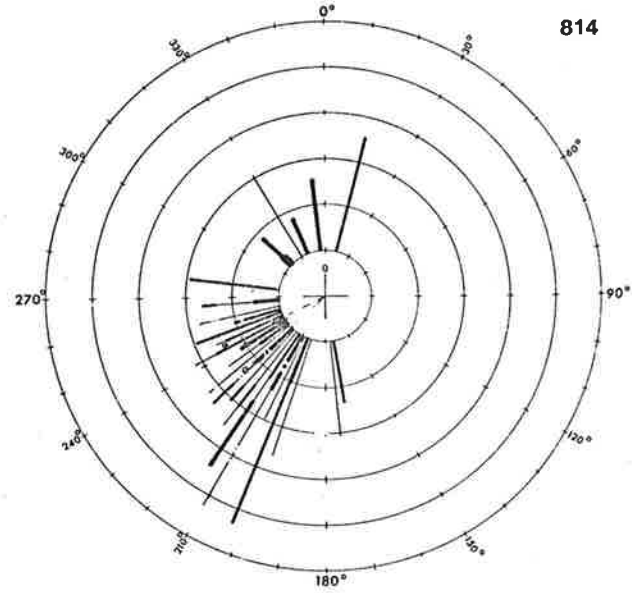

814

PERSONS
 1-10 ———
 11-20 ———
 21-50 ———
 51-99 ———
 100+ ———
 - - - - - Mean Distance Dominant Direction
 ——— Distance & Direction to C.B.D.

DISTANCES
 Radial intervals — 10 km
 Inner circle = 0

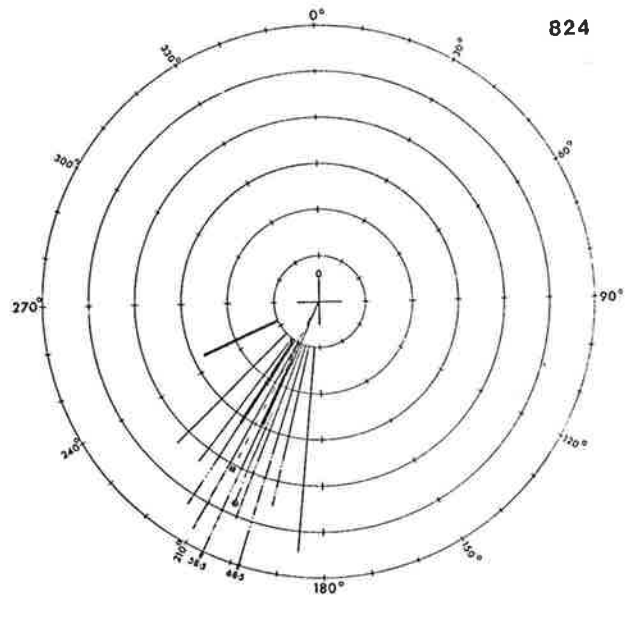
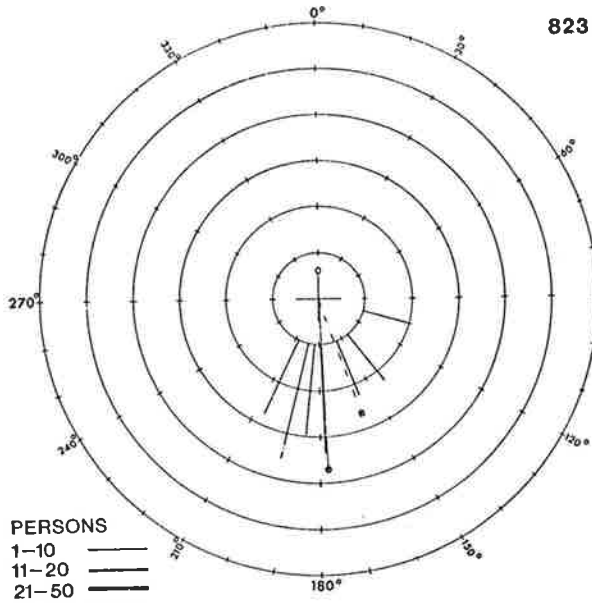

PERSONS

- 1-10
- 11-20
- 21-50
- 51-99
- 100+

- Mean Distance Dominant Direction
- Distance & Direction to C.B.D.

DISTANCES

Radial intervals - 10 km
Inner circle = 0

APPENDIX E

Calculated distances (km) from every centroid to every other centroid.

ELECTORAL SUBDIVISIONS - CEPTUIDS, DISTANCES, DIRECTIONS
 REAL DISTANCES (KM) BETWEEN SUBDIVISIONS

ORIGIN S/D	DESTINATION S/D																	
	711	712	713	714	715	716	722	724	730	731	732	736	741	742	743	744	745	751
711	0.0	7.6	5.4	6.7	3.4	3.8	15.2	12.6	31.4	15.3	14.8	29.5	26.3	10.3	13.7	18.4	16.2	3.1
712	7.6	0.0	2.7	2.2	5.1	3.9	20.2	15.1	34.0	22.7	22.3	37.0	18.8	3.5	7.4	10.9	8.6	9.6
713	5.9	2.7	0.0	3.9	2.8	3.1	17.5	12.5	37.1	20.5	20.6	35.5	20.5	4.4	7.8	12.6	10.8	7.3
714	6.7	2.2	3.9	0.0	5.2	3.0	20.7	16.2	37.9	22.0	21.1	35.5	20.3	5.7	9.6	12.6	10.0	9.2
715	3.4	5.1	2.8	5.2	0.0	2.6	15.5	11.3	34.3	17.7	17.8	32.8	23.3	7.1	10.4	15.4	13.5	4.6
716	3.8	3.9	3.1	3.0	2.6	0.0	17.9	13.9	34.2	19.1	18.4	33.1	22.7	7.0	10.7	14.8	12.5	6.3
722	15.2	20.2	17.5	20.7	15.5	17.9	0.0	6.9	27.0	11.0	16.0	29.1	35.4	20.6	21.7	28.0	27.4	12.1
724	12.6	15.1	12.5	16.2	11.3	13.9	6.9	0.0	33.0	15.9	19.6	34.0	28.6	14.7	15.2	21.5	21.3	9.9
730	31.4	39.0	37.1	37.9	34.3	35.2	27.0	33.0	0.0	17.4	16.8	34.0	27.7	7.7	57.6	41.5	49.7	29.9
731	15.3	22.7	20.5	22.0	17.7	19.1	11.0	15.9	17.4	0.0	5.9	14.2	40.4	24.7	27.2	32.9	31.2	13.2
732	14.8	22.3	20.6	21.1	17.8	18.4	16.0	14.6	14.8	5.9	0.0	15.1	41.0	25.0	28.1	33.1	30.9	13.7
736	29.5	37.0	35.5	35.5	32.8	33.1	29.1	34.0	7.7	18.2	15.1	0.0	55.7	39.8	43.1	47.9	45.4	28.8
741	26.3	18.8	20.5	20.3	23.3	22.7	35.4	28.6	47.6	49.4	41.0	55.7	0.0	16.2	13.8	7.9	10.4	27.7
742	10.3	3.5	4.4	5.7	7.1	7.0	20.6	14.7	41.5	24.7	25.0	39.8	16.2	0.0	3.9	8.2	6.8	11.6
743	13.7	7.4	7.8	5.6	10.4	10.7	21.7	15.2	44.3	27.2	28.1	43.1	13.8	3.9	0.0	6.3	6.7	14.5
744	18.4	10.9	12.6	12.6	15.4	14.8	28.0	21.5	41.7	32.9	33.1	47.9	7.9	8.2	6.3	0.0	3.4	19.8
745	16.2	8.6	10.8	10.0	13.5	12.5	27.4	21.3	47.6	31.2	30.9	45.4	10.4	6.8	6.7	3.4	0.0	18.0
751	3.1	9.6	7.3	9.2	4.6	6.3	12.1	9.9	24.9	13.2	13.7	24.8	27.7	11.6	14.5	19.8	18.0	0.0
752	8.4	15.7	13.5	15.0	10.7	12.1	10.0	11.7	24.9	7.0	8.2	23.3	33.9	17.7	20.5	26.0	24.2	6.2
753	4.7	8.6	6.0	9.0	3.8	6.3	11.7	7.9	32.1	15.0	16.2	31.3	25.4	9.8	12.2	18.0	16.6	2.8
754	5.1	12.7	10.7	11.8	7.9	8.9	12.4	12.2	26.4	10.2	9.9	25.0	31.2	15.1	18.2	23.3	21.3	3.8
755	3.2	7.0	4.5	7.1	1.9	4.4	13.6	9.8	32.8	16.0	16.6	31.6	24.8	8.7	11.6	16.9	15.2	1.6
756	2.3	9.6	7.6	8.9	4.9	6.0	13.3	11.4	29.5	13.1	12.9	27.9	28.2	12.0	15.2	20.2	18.2	7.4
771	7.0	14.2	12.9	12.7	10.4	10.3	16.2	16.5	25.3	11.3	8.6	22.8	33.0	17.2	20.7	25.1	22.7	9.1
772	10.5	18.1	16.2	17.1	13.4	14.3	12.8	15.3	24.9	5.7	4.6	19.7	36.7	20.5	23.6	28.8	26.7	3.9
773	3.2	10.7	9.1	9.5	6.5	6.8	14.8	13.6	24.4	12.8	11.7	26.4	29.4	13.5	16.9	21.5	19.3	7.2
774	5.7	12.4	11.4	10.7	9.1	8.6	17.5	16.8	27.6	14.0	12.1	26.3	29.4	13.8	17.4	21.6	19.1	5.6
775	3.9	10.7	9.6	9.1	7.3	6.8	16.8	15.5	24.1	9.3	7.3	22.1	33.8	17.8	21.1	25.9	23.6	7.0
776	7.5	15.0	13.4	13.8	10.7	11.2	14.3	15.2	34.5	20.0	17.8	31.2	25.1	11.1	15.0	17.7	14.7	9.3
781	6.2	7.6	8.1	5.4	7.5	5.2	21.4	18.5	34.5	20.0	17.8	31.2	25.1	11.1	15.0	17.7	14.7	9.3
782	8.7	13.2	13.1	11.1	11.8	10.0	22.0	20.9	30.0	17.6	13.9	26.1	30.9	16.7	20.5	23.5	20.5	11.1
783	8.6	11.0	11.6	8.8	10.6	8.5	23.2	21.1	33.2	20.1	16.9	29.3	28.0	14.5	18.4	20.8	17.7	11.5
784	5.1	8.9	8.8	6.9	7.4	5.7	19.9	17.6	32.1	17.8	15.4	29.0	27.1	12.3	16.2	19.5	16.7	8.0
785	5.1	5.2	5.7	3.1	5.4	2.9	20.2	16.6	35.3	20.0	18.5	32.6	23.3	8.7	12.6	15.7	12.9	8.1
786	3.3	8.7	8.0	7.0	6.1	5.0	17.9	15.8	31.2	16.2	14.4	28.5	27.3	11.9	15.7	19.6	16.9	6.1
791	11.7	18.9	17.6	17.4	15.0	15.1	17.8	19.6	21.1	9.7	4.9	18.0	37.7	21.9	25.4	29.9	27.4	11.6
792	9.8	16.6	15.6	14.9	13.2	12.8	18.8	19.5	24.1	12.1	8.0	20.7	35.2	19.8	23.4	27.5	24.8	10.5
793	8.6	14.8	14.1	12.9	11.9	11.1	19.6	19.6	26.5	14.1	10.3	23.0	33.2	18.1	21.8	25.6	22.8	10.0
794	21.4	28.8	27.3	27.3	24.7	24.9	22.7	26.8	12.1	11.7	7.3	8.1	47.6	31.7	35.0	39.7	37.3	20.8
8 1	9.4	8.9	10.3	6.7	10.3	7.7	24.6	21.5	34.8	22.9	20.3	33.1	24.5	12.3	16.1	17.7	14.4	12.5
8 2	9.2	5.5	7.5	3.7	8.6	6.1	24.0	19.8	34.2	24.4	22.4	36.1	20.6	8.4	12.1	13.5	10.3	12.1
8 3	10.1	7.9	9.8	6.0	10.3	7.7	25.3	21.7	34.7	24.4	22.1	35.1	22.5	11.0	14.7	15.8	12.5	13.3
8 4	15.0	11.7	14.0	10.2	15.0	12.4	30.2	26.3	42.7	29.1	26.4	38.5	22.0	14.1	17.3	16.6	13.2	18.1
8 5	7.4	5.3	6.8	3.1	7.3	4.7	22.4	18.6	37.3	22.3	20.6	34.3	22.1	8.7	12.6	14.7	11.7	10.5
811	7.3	6.0	3.6	7.5	4.1	6.1	14.8	9.2	36.7	19.6	20.7	35.8	21.3	5.8	7.7	13.6	12.6	7.1
812	5.7	8.6	5.9	9.2	4.1	6.7	11.6	7.2	31.0	15.8	17.2	32.3	25.1	9.4	11.5	17.4	16.1	3.9
813	7.2	4.0	1.9	5.6	3.8	5.0	16.9	11.3	37.8	20.9	21.5	36.5	19.9	3.9	6.6	12.0	10.7	7.9
814	13.5	8.3	7.9	13.5	10.1	11.0	20.0	13.3	43.4	26.2	27.5	42.6	15.3	5.0	2.2	8.3	8.9	13.8
823	27.4	20.2	22.7	20.7	25.2	23.6	39.7	33.6	54.4	42.7	41.6	55.2	10.0	19.1	18.7	12.7	12.4	29.7
824	37.4	30.0	31.6	31.7	34.3	33.9	44.9	37.9	64.5	51.4	52.1	67.0	11.5	27.2	24.2	19.1	21.8	38.6
PC0	2.7	5.2	4.3	4.0	2.9	1.3	17.5	14.0	33.9	18.0	17.2	31.7	24.0	8.3	12.0	16.2	13.8	5.5
CR0	.5	7.2	5.7	6.2	3.3	3.3	15.8	13.0	31.8	15.8	15.1	29.8	25.9	10.0	13.5	18.0	15.8	3.7

ELECTORAL SUBDIVISIONS - CENTROIDS, DISTANCES, DIRECTIONS
 REAL DISTANCES (KM) BETWEEN SUBDIVISIONS

ORIGIN S/D	DESTINATION S/D																	
	752	753	754	755	756	771	772	773	774	775	776	781	782	783	784	785	786	791
711	8.4	4.7	5.1	3.2	2.3	7.0	10.5	3.2	5.7	3.9	7.5	6.2	8.7	8.6	5.1	5.1	3.3	11.7
712	15.7	8.6	12.7	7.0	9.6	14.2	18.1	10.7	12.4	10.7	15.0	7.6	13.2	11.0	8.9	5.2	8.7	18.9
713	13.5	6.0	10.7	4.5	7.6	12.9	16.2	9.1	11.4	9.6	13.4	4.1	13.1	11.4	8.8	5.7	8.0	17.6
714	15.0	9.0	11.8	7.1	8.9	12.7	17.1	9.5	11.7	9.1	13.8	5.4	11.1	8.8	6.9	3.1	7.0	17.4
715	10.7	3.8	7.9	1.9	4.9	10.4	13.4	6.5	7.1	7.3	10.7	7.5	11.6	10.6	7.4	5.4	6.1	15.0
716	12.1	6.3	8.9	4.4	6.0	10.3	14.3	6.8	3.6	6.8	11.2	5.2	10.0	8.5	5.7	2.9	5.0	15.1
722	10.0	11.7	12.4	13.6	13.3	16.2	12.8	14.8	17.5	16.8	14.3	21.4	22.0	23.2	19.9	20.2	17.9	17.8
724	11.7	7.9	12.2	9.8	11.4	16.5	15.3	13.6	14.8	15.5	15.2	14.5	20.9	21.1	17.6	16.6	15.8	19.6
730	23.9	32.1	26.4	32.8	29.5	25.3	28.9	28.4	27.6	28.9	24.1	24.5	30.0	33.2	32.1	35.3	31.2	21.1
731	7.0	15.0	10.2	16.0	13.1	11.3	5.7	12.8	13.5	14.0	9.3	20.0	17.6	20.1	17.8	20.0	16.2	9.7
732	8.2	16.2	9.9	16.6	12.4	8.6	4.6	11.7	10.9	12.1	7.3	17.8	13.9	16.9	15.4	18.5	14.4	4.9
736	23.3	31.3	25.0	31.6	27.9	22.8	19.7	26.4	24.7	26.3	22.1	21.2	26.1	29.3	29.0	32.6	28.5	18.0
741	33.9	25.8	31.2	24.8	28.2	33.0	36.7	29.4	31.0	29.4	33.8	25.1	30.9	28.0	27.1	23.3	27.3	37.7
742	17.7	9.8	15.1	8.7	12.0	17.2	20.5	13.5	15.5	13.8	17.8	11.1	16.7	14.5	12.3	8.7	11.9	21.9
743	20.5	12.2	18.2	11.6	15.2	20.7	23.6	16.9	19.2	17.4	21.1	15.0	20.5	18.4	16.2	12.6	15.7	25.4
744	26.0	18.0	23.3	16.9	20.2	25.1	28.8	21.5	23.3	21.6	25.9	17.7	23.5	20.8	19.5	15.7	19.6	29.9
745	24.2	16.6	21.3	15.2	18.2	22.7	26.7	19.3	21.7	19.1	23.6	14.7	20.5	17.7	16.7	12.9	16.9	27.4
751	6.2	2.8	3.8	2.9	1.6	7.4	9.1	3.9	7.2	5.6	7.0	9.3	11.1	11.5	8.0	8.1	6.1	11.6
752	0.0	8.3	3.4	9.1	6.1	6.3	3.7	6.2	8.0	7.8	4.4	13.5	12.6	14.4	11.5	13.3	9.7	8.1
753	8.3	0.0	6.5	2.0	4.3	10.2	11.6	6.6	7.8	8.2	9.8	10.6	13.4	13.3	9.8	8.8	8.0	14.4
754	3.4	6.5	0.0	6.6	3.1	4.2	5.5	2.8	5.1	4.5	3.3	10.1	9.7	11.1	8.1	9.8	6.3	7.9
755	9.1	2.0	6.6	0.0	3.8	9.7	12.0	5.8	4.8	7.1	9.6	8.7	12.0	11.5	8.1	6.9	6.5	14.2
756	6.1	4.3	3.1	3.8	0.0	6.0	8.5	2.3	5.6	4.0	5.9	8.1	9.5	10.0	8.6	7.3	4.7	10.4
771	6.3	10.2	4.2	9.7	6.0	0.0	5.6	3.9	2.4	3.6	2.1	9.2	6.4	8.8	6.9	10.0	5.8	4.8
772	3.7	11.6	5.5	12.0	8.5	5.6	0.0	7.6	7.9	8.5	3.6	14.5	11.9	14.4	12.2	14.8	10.8	5.0
773	6.2	6.6	8.8	5.8	2.3	3.9	7.6	0.0	3.3	1.9	4.4	7.3	7.4	8.4	5.3	7.2	3.5	8.5
774	8.0	9.8	5.1	8.8	5.6	2.4	7.9	3.3	1.0	1.8	4.3	6.9	4.6	6.6	4.5	7.9	3.7	5.7
775	7.8	8.2	4.5	7.1	4.0	3.6	8.5	1.9	1.8	0.0	5.0	5.9	5.5	6.6	3.7	6.4	2.3	8.3
776	4.4	9.8	3.3	9.6	5.9	2.1	3.6	4.4	4.3	5.0	0.0	10.9	8.5	10.9	8.6	11.3	7.2	4.7
781	13.5	10.6	10.1	8.7	8.1	9.2	14.5	7.3	6.9	5.9	10.9	9.0	5.8	3.5	2.3	2.5	3.8	13.4
782	12.6	13.4	9.7	12.0	9.5	6.4	11.9	7.4	4.6	5.5	8.5	5.8	0.0	3.3	4.4	8.0	5.5	9.1
783	14.4	13.3	11.1	11.5	10.0	8.8	14.4	8.4	6.6	6.6	10.9	3.5	3.3	0.0	3.5	5.9	5.4	12.2
784	11.5	9.8	8.1	8.1	6.6	6.9	12.2	5.3	4.5	3.7	8.6	2.3	4.4	3.5	0.0	3.8	2.0	11.1
785	13.3	8.8	9.8	6.9	7.3	10.0	14.8	7.2	7.9	6.4	11.3	2.5	8.0	5.9	3.8	0.0	4.2	14.6
786	9.7	8.0	6.3	6.5	4.7	5.8	10.8	3.5	3.7	2.3	7.2	3.8	5.5	5.4	2.0	4.2	0.0	10.5
791	8.1	14.4	7.9	14.2	10.4	4.8	5.0	8.5	6.7	8.3	4.7	13.4	9.1	12.2	11.1	14.6	10.5	0.0
792	8.8	13.3	7.3	12.7	9.1	3.1	6.8	6.9	4.2	6.0	4.5	13.6	6.0	9.1	8.3	11.9	7.9	3.1
793	9.8	12.7	7.5	11.7	8.4	3.4	8.5	6.1	2.9	4.7	5.4	8.3	3.6	6.7	6.2	9.9	6.2	5.5
794	15.5	23.4	17.0	23.6	19.9	14.6	11.9	18.2	16.6	18.2	14.0	23.2	18.3	21.5	21.0	24.5	20.4	9.9
801	16.7	13.7	13.3	11.7	11.4	11.9	17.3	10.5	7.5	8.9	13.7	3.2	7.0	3.7	5.2	4.9	7.0	15.7
802	17.4	12.4	14.0	10.4	11.4	13.9	18.9	11.3	11.6	10.4	15.1	4.8	10.4	7.4	7.1	4.2	8.1	18.2
803	18.0	14.0	14.5	12.0	12.3	13.6	18.9	11.7	11.2	10.4	15.3	4.5	9.1	5.8	6.7	5.2	8.3	17.6
804	22.7	18.7	19.3	14.7	17.2	18.0	23.5	16.5	15.7	15.1	19.9	9.2	12.7	9.5	11.3	10.0	13.0	21.7
805	15.6	11.0	12.1	9.0	9.7	12.0	17.0	9.5	3.7	8.5	13.5	3.1	8.9	6.1	5.3	2.3	6.2	16.4
811	12.9	4.6	10.9	4.3	8.1	14.0	16.1	10.2	13.0	11.2	14.0	11.3	15.7	14.6	11.5	8.9	10.2	18.5
812	9.2	1.1	7.6	2.6	5.4	11.3	12.6	7.7	10.9	9.2	10.9	11.3	14.4	14.1	10.7	9.4	9.0	15.5
813	14.0	5.9	17.6	5.0	8.6	14.2	17.0	10.4	12.9	11.1	14.5	13.1	15.0	13.5	10.6	7.6	9.7	18.9
814	19.6	11.3	11.6	11.0	14.7	20.5	22.9	16.6	19.2	17.4	20.6	15.7	21.0	19.2	16.7	13.2	15.9	25.1
823	35.7	28.6	32.6	27.1	29.6	33.0	37.8	30.2	30.8	29.5	34.4	24.0	29.2	25.9	26.3	23.1	27.2	37.4
824	44.7	36.4	42.2	35.7	39.2	44.2	47.7	40.6	42.4	40.7	44.9	34.6	42.4	39.4	38.5	34.7	38.6	49.0
PC6	11.1	6.1	7.8	4.2	5.0	9.0	13.1	5.5	7.2	5.5	9.9	4.6	8.9	7.7	4.6	2.7	3.7	13.7
CD0	8.9	5.1	5.6	3.5	2.8	7.2	10.9	3.5	5.8	4.0	7.8	5.7	8.5	8.2	4.7	4.5	3.0	11.9

ELECTORAL SUBDIVISIONS - CENTROIDS, DISTANCES, DIRECTIONS
 REAL DISTANCES (KMS) BETWEEN SUBDIVISIONS

ORIGIN S/D	DESTINATION S/D													PC6	C6D	
	792	793	794	801	802	803	804	805	811	812	813	814	823			824
711	9.8	8.6	21.4	9.4	9.2	10.1	15.0	7.4	7.3	5.7	7.2	13.5	27.4	37.4	2.7	.5
712	16.6	14.8	28.8	8.9	5.5	7.9	11.7	5.3	6.0	8.6	4.0	8.3	20.2	30.0	5.2	7.2
713	15.6	14.1	27.3	10.3	7.5	9.8	14.0	6.8	3.6	5.9	1.9	7.9	22.7	31.6	4.3	5.7
714	14.9	12.9	27.3	6.7	3.7	6.0	10.2	3.1	7.5	9.2	5.6	10.5	20.7	31.7	4.0	6.2
715	13.2	11.9	24.7	10.3	8.6	10.3	15.0	7.3	4.1	4.1	3.8	10.1	25.2	34.3	2.9	3.3
716	12.8	11.1	24.9	7.7	6.1	7.7	12.4	4.7	4.1	6.7	5.0	11.0	23.6	33.9	1.3	3.3
722	18.8	19.6	22.7	24.6	24.0	25.3	30.2	22.4	14.8	11.6	16.9	20.0	39.7	44.9	17.5	15.8
724	19.5	19.6	26.8	21.5	19.8	21.7	26.3	18.6	9.2	7.2	11.3	13.3	33.6	37.9	14.0	13.0
730	24.1	26.5	12.1	36.8	39.2	38.7	42.7	37.3	36.7	33.0	37.8	43.4	58.4	68.5	33.9	31.8
731	12.1	14.1	11.7	22.9	24.2	24.4	29.1	22.3	19.6	15.8	20.9	26.2	42.7	51.4	18.0	15.8
732	8.0	10.3	7.3	20.3	22.4	22.1	26.4	20.6	20.7	17.2	21.5	27.5	41.6	52.1	17.2	15.1
736	20.7	23.0	8.1	33.1	36.1	35.1	38.5	34.3	35.8	32.3	36.5	42.6	55.2	67.0	31.7	29.8
741	35.2	33.2	47.6	24.5	20.6	22.5	22.0	22.1	21.3	25.1	19.9	15.3	10.0	11.5	24.0	25.9
742	19.8	18.1	31.7	12.3	8.4	11.0	14.1	8.7	5.8	9.4	3.9	5.0	19.1	27.2	8.3	10.0
743	23.4	21.8	35.0	16.1	12.1	14.7	17.3	12.6	7.7	11.5	6.6	2.2	18.7	24.2	12.0	13.5
744	27.5	25.6	39.7	17.7	13.5	15.8	16.6	14.7	13.6	17.4	12.0	8.3	12.7	19.1	16.2	18.0
745	24.8	22.8	37.3	14.4	10.3	12.5	13.2	11.7	12.6	16.1	10.7	9.9	12.4	21.8	13.8	15.8
751	10.5	10.0	20.8	17.5	12.1	13.3	18.1	10.5	7.1	3.9	7.9	13.8	29.7	38.6	5.5	3.7
752	8.8	9.8	15.5	16.7	17.4	18.0	22.7	15.6	12.9	9.7	14.0	19.6	35.7	44.7	11.1	8.9
753	13.3	12.7	23.4	13.7	12.4	14.0	18.7	11.0	4.6	1.1	5.9	11.3	28.6	36.4	6.1	5.1
754	7.3	7.5	17.0	13.3	14.0	14.5	19.3	12.1	10.9	7.6	11.6	17.6	32.6	42.2	7.8	5.6
755	12.7	11.7	23.6	11.7	10.4	12.0	16.7	9.0	4.3	2.6	5.0	11.0	27.1	35.7	4.2	3.5
756	9.1	8.4	19.9	11.4	11.4	12.3	17.2	9.7	8.1	5.4	8.6	14.7	29.6	39.2	5.0	2.8
771	3.1	3.4	14.6	11.9	13.9	13.6	18.0	12.0	16.0	11.3	14.2	20.5	33.0	44.2	9.0	7.2
772	6.8	8.5	11.9	17.3	18.9	18.9	23.5	17.0	16.1	12.6	17.0	22.9	37.8	47.7	13.1	10.9
773	6.9	6.1	18.2	10.5	11.3	11.7	16.5	9.5	10.2	7.7	10.4	16.6	30.2	40.6	5.5	3.5
774	4.2	2.9	16.6	9.5	11.6	11.2	15.7	9.7	13.0	10.9	12.9	19.2	30.8	42.4	7.2	5.8
775	6.0	4.7	18.2	8.9	10.4	10.4	15.1	8.5	11.2	9.2	11.1	17.4	29.5	40.7	5.5	4.0
776	4.5	5.4	14.0	13.7	15.3	15.3	19.9	13.5	14.0	10.9	14.5	20.6	34.4	44.9	9.9	7.8
781	10.6	8.3	23.2	3.2	4.8	4.5	9.2	3.1	11.3	11.3	10.1	15.7	24.0	36.6	4.6	5.7
782	6.0	3.6	18.3	7.0	10.4	9.1	12.7	8.9	15.7	14.4	15.0	21.0	29.2	42.4	8.9	8.5
783	9.1	6.7	21.5	3.7	7.4	5.8	9.5	6.1	14.6	14.1	13.5	19.2	25.9	39.4	7.7	8.2
784	8.3	6.2	21.0	5.2	7.1	6.7	11.3	5.3	11.5	10.7	10.6	16.7	26.3	38.5	4.6	4.7
785	11.9	9.9	24.5	4.9	4.2	5.2	10.0	2.3	8.9	9.4	7.6	13.2	23.1	34.7	2.7	4.5
786	7.9	6.2	20.4	7.0	8.1	8.3	13.0	6.2	10.2	9.0	9.7	15.9	27.2	38.6	3.7	3.0
791	3.1	5.5	9.9	15.7	18.2	17.6	21.7	16.4	19.5	15.5	18.9	25.1	37.4	49.0	13.7	11.9
792	0.0	2.4	12.7	12.7	15.4	14.6	18.6	13.6	17.0	14.4	17.0	23.3	34.6	46.6	11.5	9.9
793	2.4	0.0	15.0	10.3	13.1	12.2	16.2	11.4	15.9	13.8	15.7	22.0	32.3	44.6	9.8	8.6
794	12.7	15.0	0.0	25.2	28.1	27.2	30.9	26.2	27.8	24.4	28.5	34.6	47.2	58.8	23.6	21.7
8-1	12.7	10.3	25.2	0.0	4.2	2.1	6.2	3.6	13.7	14.3	12.2	17.2	22.2	36.0	7.5	8.9
8-2	15.4	13.1	28.1	4.2	0.0	2.6	6.5	1.9	11.1	12.7	9.2	13.4	19.2	32.0	6.6	8.6
8-3	14.6	12.2	27.2	2.1	2.6	0.0	4.9	3.1	13.4	14.4	11.6	16.0	20.1	33.9	7.9	9.6
8-4	18.6	16.2	30.9	6.2	8.5	4.9	0.0	7.8	17.6	19.1	15.6	19.0	17.5	33.1	12.7	14.5
8-5	13.6	11.4	26.2	3.6	1.9	3.1	7.8	0.0	10.4	11.4	8.7	13.6	21.1	33.5	5.0	6.9
811	17.0	15.9	27.8	13.7	11.1	13.4	17.6	10.4	0.0	3.8	2.1	6.8	24.9	31.9	6.9	7.3
812	14.4	13.8	24.4	14.3	12.7	14.4	19.1	11.4	3.8	0.0	5.5	10.4	28.3	35.7	6.7	6.0
813	17.0	15.7	28.5	12.2	9.2	11.6	15.6	8.7	2.1	5.5	0.0	6.3	22.9	30.7	6.1	7.1
814	23.3	22.0	34.6	17.2	13.4	16.0	19.0	13.6	6.8	10.4	6.3	0.0	20.8	25.3	12.2	13.4
823	34.6	32.3	47.2	22.2	19.2	20.1	17.5	21.1	24.9	28.3	22.9	20.8	0.0	17.6	24.8	26.9
824	46.6	44.6	58.8	36.0	32.0	33.9	33.1	33.6	31.9	35.7	30.7	25.3	17.6	0.0	35.3	37.1
PC6	11.5	9.8	23.6	7.5	6.6	7.9	12.7	5.0	6.9	6.7	6.1	12.2	24.8	35.3	0.0	2.2
C6D	9.9	8.6	21.7	8.9	8.6	9.6	14.5	6.9	7.3	6.0	7.1	13.4	26.9	37.1	2.2	0.0

APPENDIX F

Direction in degrees from every centroid to every other centroid with reference to north.

ELECTORAL SUBDIVISIONS - CENTROIDS, DISTANCES, DIRECTIONS
 DIRECTIONS (DEGREES) BETWEEN SUBDIVISIONS

ORIGIN S/D	DESTINATION S/D																		
	711	712	713	714	715	716	722	724	730	731	732	736	741	742	743	744	745	751	
711	0.0	12.0	30.5	355.5	45.0	2.9	132.8	106.1	141.9	174.9	197.3	205.0	18.7	26.6	35.6	20.3	11.6	133.0	
712	192.0	0.0	166.7	250.0	170.7	200.9	151.6	136.1	141.9	180.6	195.5	213.1	21.4	59.7	59.8	26.1	11.2	175.7	
713	210.5	328.3	0.0	293.6	192.6	244.8	152.1	133.5	174.8	184.6	201.1	216.7	15.3	21.3	39.5	15.6	1.3	185.6	
714	175.5	70.0	113.6	0.0	145.4	166.0	145.4	128.8	141.1	175.1	190.5	210.5	26.2	63.7	62.2	33.2	22.4	162.2	
715	225.0	350.7	12.6	325.4	0.0	101.8	145.5	121.4	145.0	183.4	202.4	217.9	15.0	17.9	32.5	15.0	3.6	191.3	
716	182.9	20.9	64.8	346.0	121.8	0.0	142.1	121.5	141.9	176.5	194.3	213.4	21.3	39.2	46.6	24.7	14.3	160.4	
722	312.8	331.6	332.1	325.4	325.5	322.1	0.0	7.2	224.9	243.4	250.5	239.1	155.5	341.4	351.5	350.1	343.2	312.7	
724	286.1	316.1	313.5	308.8	301.4	301.5	187.2	0.0	214.2	222.2	237.2	237.3	152.7	329.5	344.4	344.7	335.5	277.8	
730	11.9	11.9	14.8	9.1	15.0	11.0	40.9	34.2	0.0	26.9	7.2	313.1	15.0	15.5	19.1	15.0	11.8	17.1	
731	354.9	17.3	15.5	21.1	18.5	22.4	356.5	63.4	42.2	218.9	0.0	281.7	231.7	104.0	7.6	14.1	8.8	4.1	
732	17.3	15.5	21.1	18.5	22.4	14.3	76.5	57.2	147.2	101.7	0.0	214.4	18.2	21.1	26.1	19.0	14.3	29.2	
736	26.0	23.1	26.7	20.5	27.9	23.4	56.1	47.3	124.1	51.7	34.4	0.0	22.5	26.1	29.0	23.8	20.4	31.9	
741	198.7	201.4	195.3	206.2	195.0	201.3	175.5	172.7	145.0	190.0	198.2	212.5	0.0	193.7	181.9	195.0	249.8	192.8	
742	206.6	239.7	201.3	243.7	197.9	219.2	161.4	149.5	174.5	187.6	201.1	216.1	13.7	0.0	60.0	12.5	348.6	191.5	
743	215.6	239.8	219.5	242.2	212.5	226.6	171.5	164.4	174.1	194.1	209.1	219.0	1.9	240.0	0.0	345.3	315.0	203.1	
744	200.3	206.1	195.4	213.2	195.0	204.7	170.1	164.7	134.0	188.8	199.0	213.8	15.0	192.5	165.3	0.0	246.3	171.9	
745	191.6	191.2	181.3	202.4	183.6	194.3	163.2	155.5	141.8	183.5	194.3	210.9	29.8	168.6	135.0	66.3	0.0	183.1	
751	313.0	355.7	5.6	342.2	1.3	340.4	132.7	97.8	147.1	184.1	209.2	211.9	12.8	11.5	23.1	11.9	3.1	0.0	
752	350.2	6	6.8	352.5	5.2	354.1	102.1	65.8	149.4	180.6	224.9	214.1	11.9	10.3	18.7	11.0	4.3	8.1	
753	277.7	338.9	343.7	324.4	323.1	314.4	146.2	111.1	200.4	192.9	214.0	214.2	8.3	359.5	15.6	5.4	355.0	237.7	
754	5	7.4	16.6	357.7	18.0	1.5	114.9	82.2	144.1	172.1	205.8	211.0	15.8	18.0	26.2	16.0	8.9	38.1	
755	258.8	346.7	357.7	328.4	336.3	316.4	143.9	114.8	147.1	186.6	207.2	210.7	12.2	9.4	24.5	10.9	8.3	197.8	
756	342.4	5.3	17.6	357.1	20.5	355.2	127.9	96.5	144.1	177.1	203.1	219.2	16.0	19.0	28.7	16.3	8.1	88.9	
771	37.8	24.4	34.4	17.1	40.1	25.6	197.4	82.9	185.0	150.0	180.7	212.3	22.7	31.1	36.3	25.1	19.4	62.9	
772	8.7	10.1	16.5	3.5	17.3	7.1	89.8	63.1	141.6	144.9	217.2	215.1	15.8	17.5	23.9	16.1	10.4	25.2	
773	29.1	17.1	30.0	6.2	37.3	14.9	120.7	92.9	141.0	166.9	194.0	215.6	19.8	27.2	34.4	21.6	14.5	80.6	
774	56.3	30.9	43.2	23.4	52.1	35.5	114.1	41.0	181.6	153.1	177.9	149.2	25.2	37.1	41.7	28.7	22.9	81.6	
775	58.6	27.5	41.6	18.0	52.3	31.3	119.8	46.3	146.3	160.4	184.9	211.3	23.6	35.3	40.7	26.8	20.3	91.1	
776	21.5	16.7	25.5	9.3	28.8	15.3	103.6	76.7	149.0	153.7	192.9	217.5	19.3	24.5	30.6	20.7	14.7	46.3	
782	126.2	60.2	79.7	56.1	88.6	130.9	112.7	149.5	161.5	178.0	194.7	32.3	60.0	60.0	40.0	34.1	128.5		
783	84.5	51.2	63.1	47.4	73.7	62.5	115.6	97.3	125.8	145.2	162.0	149.4	33.6	53.0	54.3	39.8	35.6	76.8	
784	105.3	62.9	76.4	61.0	90.0	80.7	123.3	106.2	177.0	151.6	166.9	149.2	36.5	62.1	61.7	44.6	40.5	113.4	
795	149.2	46.8	64.5	39.5	81.6	64.4	125.0	105.8	142.8	159.3	178.0	136.0	29.5	50.5	52.7	35.4	29.4	115.8	
796	149.2	43.8	62.4	42.1	111.3	101.7	136.8	114.1	144.3	168.6	185.5	138.5	28.3	56.2	57.3	34.9	27.0	143.0	
797	94.2	34.1	52.3	23.2	69.1	44.4	126.2	103.6	144.9	163.4	184.4	199.8	25.4	41.4	45.9	29.6	22.7	113.2	
798	34.0	25.4	32.9	20.2	36.5	26.6	42.2	71.6	174.9	125.3	153.8	219.7	23.4	30.6	34.9	25.7	21.0	49.6	
799	47.2	32.0	41.0	26.6	46.7	35.3	101.4	84.6	174.3	135.2	159.2	196.0	26.4	36.7	40.5	29.6	24.9	64.6	
800	60.3	37.8	48.2	32.5	56.0	43.6	108.1	87.7	177.9	141.3	162.5	193.7	28.6	41.9	45.1	32.8	28.1	77.8	
801	27.0	23.1	27.8	19.7	29.4	23.4	67.4	54.4	144.6	71.0	46.9	213.2	22.4	26.9	30.4	23.9	20.4	35.4	
802	129.7	80.8	95.5	84.4	110.4	106.6	131.6	116.2	174.9	158.0	171.9	149.9	39.7	74.9	71.3	50.5	46.8	130.5	
803	155.5	99.6	115.3	117.1	133.7	138.8	141.3	124.7	164.0	167.7	181.5	144.7	36.5	84.2	76.6	48.8	43.1	149.8	
804	141.3	93.6	106.7	102.2	122.2	122.3	136.2	121.8	121.2	161.6	174.9	130.8	41.1	83.4	77.3	53.8	50.4	139.3	
805	141.8	111.9	118.6	120.4	128.8	130.2	137.2	125.6	144.2	154.5	169.3	145.4	53.6	100.6	92.2	70.9	72.1	140.3	
806	150.4	79.4	101.3	86.1	123.7	124.7	138.5	122.3	144.4	167.0	182.0	145.7	33.2	71.6	68.0	42.9	36.3	145.3	
807	239.9	308.6	293.8	293.7	252.3	271.2	160.8	141.1	210.4	194.7	211.1	212.5	5.7	342.9	12.6	3	366.0	214.6	
808	271.0	331.5	333.0	317.5	307.6	305.3	151.7	117.8	211.6	195.9	215.7	215.1	6.3	353.5	11.6	2.4	351.4	238.7	
809	223.0	302.3	264.3	283.9	271.2	252.3	158.2	141.0	197.6	189.9	205.7	219.3	10.1	355.0	27.5	6.9	351.0	199.5	
810	224.9	254.7	235.6	253.7	224.8	238.2	175.3	169.1	211.7	198.2	210.5	211.9	355.4	265.3	314.5	337.5	314.9	211.7	
811	177.4	171.9	169.2	174.0	171.7	176.5	161.8	156.7	144.2	176.5	184.3	192.4	104.5	162.2	150.4	143.1	148.7	173.2	
812	203.5	206.3	202.1	209.1	201.4	205.7	184.7	144.3	149.2	195.3	201.7	224.6	14.4	202.3	196.6	206.5	212.2	149.1	
813	169.1	23.5	54.7	359.7	94.3	30.9	138.0	115.9	130.2	174.1	193.1	213.1	21.9	37.9	44.9	25.2	15.9	149.6	
814	149.8	14.9	35.3	357.7	54.1	7.9	133.3	107.8	141.3	174.1	195.8	215.1	19.6	29.2	37.7	21.7	24.9	135.5	

ELECTIONAL SUBDIVISIONS - CENTROIDS, DISTANCES, DIRECTIONS

DIRECTIONS (DEGREES) BETWEEN SUBDIVISIONS

ORIGIN S/D	752	753	754	755	756	771	772	773	774	775	776	781	782	783	784	785	786	791
711	170.2	97.7	180.5	78.8	162.4	217.8	188.7	209.1	246.3	238.6	201.5	345.2	264.5	246.3	285.2	329.2	274.2	214.0
712	180.6	158.4	187.4	166.7	185.3	204.4	180.1	197.1	219.9	207.5	196.7	230.2	231.2	242.9	226.8	233.8	244.1	205.4
713	186.8	163.7	196.6	177.7	197.6	214.4	186.5	210.0	229.2	221.6	205.5	259.7	243.1	256.4	244.5	262.4	232.3	212.9
714	172.5	144.4	177.7	148.4	172.1	197.1	183.5	196.2	203.4	194.0	189.3	236.1	227.4	241.0	219.5	222.1	233.2	200.2
715	185.2	143.1	198.0	156.3	200.5	220.1	197.3	217.3	232.1	232.3	208.8	270.6	253.7	270.0	261.6	291.3	269.1	216.5
716	174.1	134.4	181.5	136.4	175.2	205.6	187.1	174.9	215.5	211.3	195.7	269.6	242.5	260.7	244.4	281.7	294.4	206.6
722	282.1	326.2	294.9	323.9	307.9	287.4	289.8	300.7	274.1	299.8	283.6	311.9	295.6	303.3	306.0	316.8	336.2	272.2
724	245.8	291.1	262.2	294.8	276.5	262.9	243.1	272.9	271.0	275.3	256.7	242.7	277.3	286.2	285.8	298.1	283.6	251.6
720	19.4	20.4	14.1	17.1	14.1	5.0	13.6	10.0	3.6	6.3	9.0	2.5	355.8	357.0	2.8	6.3	5.9	359.9
731	.6	12.9	352.1	6.6	357.1	330.0	328.9	346.9	333.1	340.4	333.7	311.5	325.2	331.6	339.3	348.6	343.4	305.3
732	44.9	34.0	25.8	27.2	23.1	.7	37.2	14.0	357.9	4.9	12.4	348.0	342.0	346.9	358.0	5.5	4.4	333.8
736	38.1	34.2	31.0	30.7	29.2	22.3	35.1	25.6	17.2	21.3	27.5	14.7	9.4	9.2	16.0	18.5	19.8	20.7
741	191.9	188.3	195.8	192.2	196.0	202.7	195.8	199.8	215.2	203.6	199.7	212.3	211.6	216.5	209.5	208.3	235.4	203.4
742	190.3	179.5	198.0	189.4	199.0	211.1	197.5	207.2	217.1	215.3	204.5	211.0	233.0	242.1	230.5	236.2	221.4	210.6
743	198.7	195.6	206.2	204.5	208.7	216.3	203.9	214.4	221.7	220.7	210.6	248.0	234.3	241.7	232.7	237.3	225.9	214.9
744	191.0	185.4	196.9	190.9	196.3	205.1	196.1	201.7	206.8	200.7	227.0	219.8	224.6	215.4	214.9	214.9	205.7	205.7
745	184.3	175.0	188.9	186.3	188.1	199.4	190.4	194.5	212.9	200.3	194.7	214.1	215.6	220.5	209.4	207.0	202.7	201.0
749	188.1	171.7	218.1	177.8	269.9	262.9	265.2	263.6	331.8	331.2	322.5	287.1	311.7	306.3	317.9	325.5	342.3	331.0
752	0.0	23.2	334.7	311.2	353.1	295.7	234.2	331.8	244.9	260.1	229.6	233.9	269.1	283.2	281.6	304.4	276.3	231.2
753	203.2	0.0	226.4	310.0	248.9	241.4	212.7	211.0	244.9	260.1	235.9	331.7	296.5	312.7	323.1	344.9	339.0	235.0
754	154.7	46.4	0.0	29.3	14.0	265.0	146.3	327.5	244.4	247.8	218.0	241.3	263.0	278.8	275.0	302.8	266.6	223.3
755	191.2	130.0	209.3	0.0	221.6	230.5	263.4	234.2	244.4	247.8	218.0	241.3	263.0	278.8	275.0	302.8	266.6	223.3
756	173.1	68.9	194.0	41.6	0.0	236.1	195.5	264.9	253.5	271.9	215.7	315.8	278.1	297.2	302.1	333.2	311.4	223.9
771	115.7	61.4	85.0	50.5	56.1	0.0	151.1	44.9	347.7	14.9	133.8	354.5	316.6	333.5	354.7	9.6	9.8	208.6
772	54.6	32.7	16.3	23.4	15.5	331.1	0.0	.2	325.1	248.1	341.2	346.4	323.4	332.6	344.1	356.0	350.9	278.2
773	151.4	71.0	147.5	54.2	74.9	224.9	180.2	0.0	262.8	292.5	196.0	331.9	285.3	307.9	320.8	351.6	340.3	215.9
774	129.2	74.9	132.4	64.4	79.5	167.7	156.1	42.8	0.0	51.2	151.8	358.2	101.1	328.4	358.3	16.1	23.6	195.2
775	142.5	80.1	132.2	67.8	91.9	194.9	168.1	112.5	231.2	0.0	173.1	333.9	282.7	312.4	335.1	6.6	1.8	202.7
776	107.1	49.6	55.9	38.0	35.7	313.8	161.2	16.0	311.8	353.1	0.0	348.1	315.9	329.7	345.4	.7	355.8	234.5
781	151.7	113.9	150.7	110.3	135.8	175.5	166.4	151.9	174.2	163.9	168.1	0.0	219.5	248.8	178.1	73.6	153.4	166.6
782	126.3	89.1	116.5	83.0	98.1	136.6	143.4	105.3	121.1	102.7	135.9	19.5	0.0	8.2	60.1	49.5	78.7	166.4
783	137.9	103.2	132.7	98.8	117.2	153.5	152.6	127.9	142.4	32.4	149.7	68.8	188.2	0.0	107.9	70.8	113.6	172.1
784	146.5	101.6	143.1	95.0	122.1	174.7	184.1	140.8	174.3	356.1	165.4	354.1	240.1	287.9	0.0	37.4	153.7	188.4
785	162.3	124.4	164.9	122.8	153.2	189.6	176.0	171.6	146.1	186.6	180.7	253.6	229.5	250.8	217.4	0.0	109.3	195.7
786	151.0	96.3	149.0	86.6	121.4	189.8	170.9	150.3	203.6	181.8	175.8	333.4	258.7	293.5	303.7	9.3	0.0	198.2
781	79.9	51.2	55.8	43.3	43.9	28.6	48.2	35.9	17.2	22.7	54.5	6.6	346.4	352.1	8.4	15.7	18.2	0.0
732	100.5	63.1	78.0	55.0	60.4	68.7	123.6	55.6	35.0	39.9	94.1	12.1	345.7	353.6	16.0	22.7	59.6	167.7
763	114.2	73.4	96.8	65.3	75.7	111.3	136.2	76.0	64.3	61.7	119.8	11.4	340.5	353.6	24.6	29.5	31.0	179.3
774	45.9	38.0	34.8	31.2	31.6	21.9	43.2	24.8	17.3	20.5	29.9	11.8	3.2	4.0	13.3	16.9	18.4	18.7
81	148.7	119.1	147.2	117.3	135.9	165.6	161.0	147.1	165.0	156.2	160.9	134.2	192.0	195.3	153.6	109.5	165.5	177.5
82	162.5	136.6	144.5	137.8	156.9	182.0	173.3	168.6	144.9	177.5	176.1	194.3	208.1	216.7	189.1	163.3	176.3	188.7
83	154.3	127.9	154.3	127.4	145.1	171.2	165.4	155.9	172.0	163.2	166.4	162.4	195.0	198.8	167.7	133.5	148.2	180.6
84	151.9	131.7	151.4	131.8	144.5	163.9	160.9	152.1	143.3	156.8	160.8	162.2	177.3	173.5	157.3	138.1	152.5	172.7
85	160.9	130.3	162.7	130.4	153.2	182.9	173.0	167.2	144.6	177.9	176.1	205.5	214.6	228.4	193.8	153.2	176.5	190.1
811	202.3	200.6	215.8	225.9	223.9	229.1	204.3	230.7	233.3	234.5	220.4	270.0	253.3	265.1	258.3	274.5	250.4	223.9
812	207.5	241.4	228.6	286.4	247.4	241.4	215.1	249.6	241.5	257.9	230.8	249.4	267.1	280.2	277.7	298.3	272.2	231.9
813	194.5	182.4	205.5	200.6	229.6	220.4	202.6	218.8	224.8	228.5	212.1	245.6	245.8	257.6	248.1	262.4	238.4	217.5
814	204.5	205.4	213.1	215.4	217.0	222.5	209.1	221.9	224.3	227.9	216.6	247.8	240.2	248.0	240.3	246.7	233.9	214.9
823	175.7	168.0	177.9	170.6	176.3	185.3	180.5	184.6	184.6	184.1	182.5	174.0	194.8	195.6	188.0	183.4	184.3	186.1
824	197.6	196.3	200.7	199.2	201.3	205.7	200.2	203.9	207.7	206.6	203.1	211.0	213.8	215.9	211.0	210.3	214.1	206.0
826	169.9	172.1	176.6	184.4	166.0	204.9	184.7	191.0	214.3	211.4	193.2	242.9	247.1	268.3	253.7	309.5	229.3	206.1
820	169.0	102.5	177.7	87.4	160.0	213.8	186.4	211.5	233.9	230.8	198.4	344.0	261.2	283.7	280.6	329.1	265.1	211.7

ELECTORAL SUBDIVISIONS - CENTROIDS, DISTANCES, DIRECTIONS

DIRECTIONS (DEGREES) BETWEEN SUBDIVISIONS

ORIGIN S/D	DESTINATION S/D															PCG	CBD
	792	793	794	801	802	803	804	805	811	812	813	814	823	824			
711	227.2	240.3	207.0	309.7	335.5	321.3	321.8	330.4	59.9	91.0	43.0	44.9	357.4	23.5	349.1	329.8	
712	212.0	217.8	203.1	260.8	279.6	273.5	291.9	259.4	129.6	151.5	122.3	74.7	351.9	26.3	203.5	194.9	
713	221.0	228.2	207.8	275.0	295.3	286.7	298.6	291.3	113.7	137.5	103.9	73.7	358.0	29.1	179.7	177.7	
714	206.6	212.5	199.7	264.4	297.1	282.2	300.4	266.1	79.3	127.6	41.2	44.8	351.7	21.4	274.3	234.1	
715	226.7	236.0	209.4	290.4	313.7	302.2	308.8	303.7	79.3	127.6	41.2	44.8	351.7	21.4	274.3	234.1	
716	215.3	223.6	203.4	286.6	318.8	302.3	310.2	304.7	91.2	125.3	72.3	58.2	356.5	25.7	210.9	187.9	
722	281.4	288.1	247.4	311.6	321.3	316.2	317.2	318.5	340.8	331.7	338.2	355.3	341.8	4.7	318.0	313.3	
724	260.6	267.7	234.4	296.2	306.7	301.8	305.6	302.3	321.1	297.8	321.0	349.1	336.7	4.3	295.9	287.8	
730	358.3	357.9	344.6	358.9	4.0	.2	356.2	4.4	29.4	21.6	17.6	21.7	5.2	18.2	10.2	11.3	
731	315.2	321.3	251.0	338.0	347.7	341.6	338.5	347.0	14.7	15.9	9.9	18.2	356.5	15.3	354.1	354.1	
732	339.2	342.5	226.9	351.9	1.5	354.9	349.3	2.0	31.1	35.7	25.7	30.5	4.3	21.7	13.1	15.8	
736	16.0	13.7	23.2	9.9	14.7	10.8	5.4	15.7	32.5	35.1	29.3	31.9	12.2	24.6	23.1	25.1	
741	206.4	208.6	202.4	219.7	216.5	221.1	233.6	213.2	189.7	186.3	190.1	175.8	284.5	34.4	201.9	199.6	
742	216.7	221.9	206.9	254.9	244.2	263.4	280.6	251.6	162.9	173.5	175.0	95.3	342.2	22.3	217.9	209.2	
743	220.5	225.1	210.4	251.3	256.6	257.3	272.2	248.0	192.6	191.6	207.5	134.5	330.4	16.6	224.9	217.7	
744	209.6	212.8	203.9	230.5	228.8	233.8	250.9	222.9	141.3	182.4	186.9	157.5	323.1	26.5	205.2	201.7	
745	204.9	208.1	200.4	226.8	223.1	230.4	252.1	216.3	156.0	171.4	171.0	134.9	338.7	32.2	195.9	192.9	
751	244.6	257.8	215.4	310.5	329.8	319.3	320.3	325.3	34.6	58.7	19.5	31.7	353.2	19.1	329.6	315.5	
752	280.5	294.2	225.9	328.7	342.5	334.3	331.9	340.9	22.3	27.5	14.5	24.5	355.7	17.6	349.9	349.0	
753	243.1	253.4	218.0	299.1	316.6	307.8	311.7	310.3	29.6	61.4	2.4	25.4	348.0	16.3	302.1	282.5	
754	258.0	276.8	214.8	327.2	344.5	334.3	331.4	342.7	35.8	48.6	25.5	33.1	357.9	20.7	356.6	357.7	
755	235.0	245.3	213.2	297.3	317.8	307.4	310.4	310.4	45.9	106.4	20.6	35.4	350.6	19.2	298.4	267.4	
756	240.4	255.7	211.6	315.9	336.9	325.1	324.5	333.2	43.9	67.4	29.6	17.0	356.3	21.3	346.0	340.0	
771	248.7	291.3	201.9	345.6	2.0	351.2	343.9	2.9	49.1	61.4	40.4	42.5	5.3	25.7	24.9	33.8	
772	303.6	316.2	223.2	341.0	353.3	345.4	340.9	353.0	29.3	35.1	22.6	29.1	5.5	20.2	4.7	6.9	
773	235.6	256.0	206.6	327.1	348.6	335.9	332.1	347.2	59.7	69.6	38.8	41.9	4.6	23.9	11.0	21.5	
774	215.0	248.3	197.3	345.0	4.9	352.0	343.3	6.6	59.3	73.5	48.8	48.3	6.6	27.7	36.3	50.9	
775	219.9	241.7	200.5	334.2	357.5	343.2	336.8	357.9	59.5	77.9	48.5	47.9	4.1	26.6	31.4	50.8	
776	274.1	299.8	209.9	349.9	356.1	346.4	340.8	356.1	40.4	50.8	32.1	36.6	2.5	23.1	13.2	18.4	
791	192.1	197.4	191.8	316.2	14.3	342.4	332.2	25.5	99.0	109.4	80.6	57.8	9.0	33.0	102.9	124.0	
792	165.7	160.5	193.2	12.0	28.1	15.0	357.3	34.6	73.3	87.1	65.8	60.2	14.8	33.8	67.1	81.2	
793	173.6	173.6	194.0	15.3	36.7	18.8	353.6	48.4	45.1	100.2	77.6	58.0	15.6	35.9	88.3	103.7	
794	196.0	204.6	193.3	333.6	9.1	347.7	337.3	13.8	78.3	97.7	68.1	60.3	8.0	31.0	73.7	100.6	
795	202.7	209.5	196.9	289.5	343.3	313.5	318.1	333.2	44.5	118.3	82.9	66.7	3.4	30.3	129.5	149.1	
796	209.6	223.0	198.4	325.5	356.3	338.2	332.5	356.5	70.4	92.2	58.4	53.9	4.3	28.1	49.3	85.7	
797	347.7	350.3	198.7	357.5	8.7	.6	352.7	10.1	41.9	51.9	37.5	39.9	8.1	26.0	26.1	31.7	
798	0.0	353.5	191.5	359.9	12.8	3.4	353.6	15.1	52.6	63.0	45.4	45.9	9.9	28.3	35.8	44.2	
799	173.5	0.0	188.6	1.3	16.3	5.3	353.6	19.0	60.1	72.4	52.4	50.8	11.1	30.1	45.3	56.7	
799	11.5	8.6	0.0	5.7	12.2	7.1	8.8	13.4	35.2	39.0	31.0	33.9	10.3	24.7	23.0	25.8	
8-1	179.9	181.3	195.7	0.0	55.8	24.8	340.5	82.9	49.5	115.3	93.3	77.9	15.7	38.0	118.6	128.5	
8-2	192.8	196.3	192.2	235.8	0.0	260.7	302.3	175.8	114.8	131.7	109.1	46.6	7.6	35.7	150.0	155.9	
8-3	183.4	185.3	187.1	204.8	80.7	0.0	322.9	118.7	139.6	123.7	103.3	84.0	14.7	38.8	132.2	140.8	
8-4	173.6	173.6	180.8	190.5	122.3	142.9	0.0	133.6	117.6	128.5	119.5	96.7	27.3	47.0	136.2	141.5	
8-5	195.1	199.6	193.4	262.9	355.8	298.7	313.6	0.0	195.6	125.1	97.6	76.6	6.6	33.6	140.5	150.5	
811	232.6	240.1	215.2	279.8	294.8	288.6	297.6	285.6	0.0	189.7	320.3	28.6	342.3	15.6	261.4	244.2	
812	243.0	252.4	219.0	295.3	311.7	303.7	308.5	305.1	9.7	0.0	352.3	21.8	345.9	15.0	293.8	275.5	
813	225.4	232.4	211.0	273.3	289.1	283.0	294.5	277.6	149.3	172.3	0.0	47.0	344.4	18.9	243.8	227.2	
814	225.9	230.8	213.9	257.9	264.6	264.0	276.7	256.6	214.6	201.8	227.0	0.0	328.7	12.2	278.3	227.1	
823	189.9	191.1	190.3	195.7	187.6	194.7	207.3	186.0	162.3	165.9	164.4	158.7	0.0	66.7	178.3	177.9	
824	208.3	210.1	204.7	218.0	215.7	218.8	227.0	213.6	194.6	195.0	198.9	192.2	246.7	0.0	205.9	204.1	
PCG	215.8	225.3	203.0	296.6	330.0	312.2	316.2	329.5	81.4	113.8	63.8	55.3	358.3	25.9	0.0	173.9	
CBD	224.2	236.7	205.9	308.5	335.9	320.8	321.5	330.5	64.2	95.5	47.2	47.1	357.9	24.1	353.9	0.0	

APPENDIX G

Direction in degrees from every centroid to every other centroid with reference to the C.B.D.

ELLIPTICAL SUBDIVISIONS - DIRECTIONS
 DIRECTIONS (DEGREES FROM C.4.0.) BETWEEN SUBDIVISIONS

	DIRECTION S/O																	
ORIGIN S/O	711	712	713	714	715	716	722	724	730	731	732	736	741	742	743	744	745	751
711	-30.2	-42.2	-60.7	-25.7	-75.2	-33.1	-103.0	-116.3	137.9	154.9	132.5	123.8	-48.9	-56.8	-65.8	-50.5	-41.8	-163.2
712	2.4	-165.1	48.6	-55.1	24.2	-6.0	43.3	54.8	3.0	14.3	-6	-8.2	173.5	135.2	130.1	168.8	-176.3	19.2
713	4.4	-113.0	-144.7	-74.3	22.7	-29.5	63.2	41.8	20.5	30.7	14.2	8.6	-160.0	-166.0	175.8	-160.3	-146.0	29.7
714	2.2	107.7	64.1	177.7	32.3	11.7	32.3	48.9	-11.4	2.6	-12.8	-22.8	151.5	114.0	115.5	144.5	155.3	15.5
715	0.1	-116.0	-138.5	-91.3	-125.4	-67.7	48.0	112.7	39.1	50.7	31.7	26.2	-140.9	-143.8	-130.4	-140.9	-129.5	52.8
716	5.0	167.0	123.1	-158.1	66.1	-172.1	45.8	66.4	-3.1	11.4	-6.4	-15.5	168.6	148.7	141.3	163.2	173.6	27.5
722	.5	-18.3	-18.4	-12.1	-12.2	-8.8	-46.7	-33.9	92.4	69.9	56.8	77.2	-42.2	-28.1	-38.2	-36.8	-29.9	.6
724	1.7	-28.3	-25.7	-21.0	-13.6	-13.7	100.0	-72.2	71.6	65.6	50.6	60.5	-64.9	-41.7	-50.6	-56.9	-47.7	10.0
730	-6.6	-6	-3.5	2.2	-3.7	.3	-29.6	-22.9	11.3	-15.6	4.1	68.2	-3.7	-4.2	-7.8	-3.7	-5	-5.8
731	-2.8	-6.5	-10.5	-14.9	-9.3	-2.4	-69.3	-68.1	147.2	-5.9	72.4	122.4	-15.5	-13.5	-20.0	-14.7	-9.4	-10.0
732	-1.5	2.3	-5.3	5.3	-6.6	-2.8	1.7	-31.0	-22.2	-94.0	-26.6	-9.3	25.1	2.6	-1.0	-3.9	1.3	4.2
736	-4.9	2.0	-1.6	4.3	-5.6	4.6	-1.7	24.1	26.9	4.6	9.6	1.4	-2.9	-160.4	5.9	17.7	4.6	-10.2
741	.9	-1.8	4.3	-5.6	4.6	-1.7	24.1	26.9	4.6	9.6	1.4	-2.9	-160.4	5.9	17.7	4.6	-10.2	6.8
742	9.6	-30.5	7.9	-34.5	11.3	-10.0	47.8	59.7	13.7	21.6	8.1	3.1	-164.5	-150.8	149.2	-163.3	-139.4	17.7
743	3.1	-22.1	-1.4	-24.5	5.2	-8.9	46.2	53.3	14.6	23.6	11.6	8.7	-144.2	-22.3	-142.3	-127.6	-97.3	14.6
744	1.4	-4.4	6.1	-11.5	6.7	-3.0	31.6	37.0	6.7	12.9	2.7	-2.1	-173.3	9.2	30.4	-158.3	-44.6	9.8
745	1.3	1.7	11.6	-9.5	9.3	-1.4	29.7	37.4	1.1	9.4	-1.4	-8.0	163.1	24.3	57.9	126.6	-167.1	9.8
751	2.5	-40.2	-50.1	-26.7	-45.8	-24.9	-177.2	-142.3	119.4	131.4	106.2	103.6	-57.3	-56.0	-67.6	-56.4	-47.6	-44.5
752	-1.2	-11.6	-17.8	-3.5	-16.2	-5.1	-113.1	-76.8	149.6	168.4	124.1	130.9	-22.9	-21.3	-29.7	-22.0	-15.3	-19.1
753	4.8	-56.4	-61.2	-41.9	-40.6	-31.9	136.3	171.4	92.1	89.6	68.5	68.3	-85.6	-77.0	-93.1	-82.9	-72.5	44.8
754	-2.8	-9.7	-18.9	0.0	-20.3	-3.8	-117.2	-84.5	163.6	-174.4	151.9	146.7	-18.1	-20.3	-28.5	-18.3	-11.2	-40.4
755	8.6	-79.3	-90.3	-61.0	-62.9	-49.0	123.5	182.6	70.3	40.9	60.2	56.7	-104.8	-102.0	-117.1	-103.5	-42.9	69.6
756	-2.4	-25.3	-37.6	-12.1	-40.5	-15.2	-147.9	-116.5	145.9	162.9	136.9	130.8	-36.0	-39.6	-48.7	-36.3	-28.1	-108.9
771	-4.0	9.4	-6	16.7	-6.3	8.2	-73.6	-49.1	-161.2	-116.2	-146.9	-168.5	11.1	2.7	-2.5	8.7	14.4	-29.1
772	-1.8	-3.2	-9.6	3.4	-10.4	-2	-82.9	-56.2	173.3	-142.0	149.7	151.8	-8.5	-10.6	-17.0	-9.2	-3.5	-18.3
773	-7.6	4.4	-8.5	15.3	-15.8	6.6	-99.2	-71.4	-164.5	-145.4	-172.5	-175.9	1.7	-5.7	-12.9	-4.1	7.0	-59.1
774	-5.4	20.0	7.7	27.5	-1.2	18.4	-63.2	-40.1	-132.7	-102.2	-127.0	-148.3	25.7	13.8	9.2	22.2	28.0	-30.7
775	-7.8	23.3	9.2	32.8	-1.5	19.5	-69.0	-44.5	-135.5	-109.6	-134.1	-150.5	27.2	15.5	10.1	24.0	30.5	-40.3
776	-3.1	1.7	-7.1	9.1	-10.4	3.1	-85.2	-58.3	-170.6	-135.3	-174.5	-170.9	-4.9	-6.1	-12.2	-2.3	3.7	-27.9
781	-2.2	63.8	44.3	67.9	24.4	35.4	-6.9	11.3	-58.5	-37.5	-54.0	-70.7	91.7	64.0	64.0	84.0	89.9	-4.5
782	-3.3	30.0	18.1	33.8	7.5	18.7	-34.4	-16.1	-94.6	-64.0	-40.8	-108.2	47.6	28.2	26.9	41.4	45.6	-15.6
783	-2.6	40.8	27.3	42.7	11.7	23.0	-19.6	-2.5	-73.3	-47.9	-63.2	-85.5	67.2	41.6	42.0	59.1	63.2	-9.7
784	-4.6	53.8	36.1	61.1	15.0	36.2	-25.4	-5.2	-82.2	-58.7	-77.4	-95.4	71.1	50.1	47.9	65.2	71.2	-15.2
785	-1.1	95.3	66.7	107.0	37.4	47.4	12.3	31.0	-37.2	-19.5	-36.4	-49.4	120.8	42.9	91.8	114.2	122.1	6.1
786	-2.5	51.6	33.4	62.5	16.6	41.3	-40.5	-17.9	-100.2	-77.7	-98.7	-114.1	60.3	44.3	39.8	56.1	63.0	-27.5
791	-2.7	6.3	-1.2	11.5	-4.8	5.1	-60.5	-39.9	-144.2	-93.6	-122.1	-169.0	8.3	1.1	-3.2	6.0	10.7	-17.9
792	-3.0	12.2	3.2	17.6	-2.5	8.9	-57.2	-36.4	-134.1	-91.0	-115.0	-151.8	17.8	7.5	3.7	14.6	19.3	-20.4
793	-3.6	18.9	8.5	24.2	.7	13.1	-51.4	-31.0	-121.2	-84.6	-105.9	-137.0	28.1	14.8	11.6	23.9	28.6	-21.1
794	-1.2	2.7	-2.0	6.1	-3.6	2.4	-41.6	-29.6	-138.8	-45.2	-71.1	-177.4	3.4	-1.1	-4.6	1.9	5.4	-9.6
801	-1.2	47.7	33.5	44.1	19.1	21.9	-3.1	12.3	-58.4	-29.5	-43.4	-61.4	88.8	53.6	57.2	78.0	81.7	-2.0
802	.4	56.3	40.6	38.8	22.2	17.1	14.6	29.2	-28.1	-11.8	-25.6	-38.8	119.4	71.7	74.3	107.1	112.8	6.1
803	-5	47.2	34.1	34.6	18.6	14.5	4.6	19.0	-39.4	-20.8	-34.1	-50.0	99.7	57.4	63.5	87.0	90.4	1.5
804	-3	29.8	22.9	21.1	12.7	11.3	4.3	15.9	-34.7	-17.0	-27.8	-43.9	87.5	40.9	49.3	70.6	69.4	1.2
805	.1	71.1	49.2	64.4	26.8	25.8	12.0	24.2	-33.9	-16.5	-31.5	-45.2	117.3	78.9	84.5	107.6	114.2	5.2
811	4.3	-64.4	-49.6	-49.5	-8.1	-27.0	83.4	103.1	43.8	49.5	33.1	31.7	-121.5	-38.7	-128.4	-116.1	-101.8	29.6
812	4.5	-56.0	-57.5	-47.0	-32.1	-29.8	123.8	157.7	73.9	79.6	59.8	60.4	-90.8	-78.0	-96.1	-86.9	-75.9	36.8
813	4.2	-75.1	-37.1	-56.7	6.0	-25.1	69.0	46.2	29.6	37.3	21.5	17.9	-142.5	-127.8	-160.3	-139.7	-123.8	27.7
814	2.2	-27.6	-8.5	-24.6	2.3	-11.1	51.8	48.0	26.4	27.9	16.6	15.2	-128.7	-38.2	-87.4	-110.4	-87.8	15.4
823	.5	6.0	8.7	-1	6.2	1.4	16.1	21.2	-7.3	1.4	-6.4	-14.3	73.4	15.7	27.5	34.8	19.2	4.7
824	.6	-2.2	2.0	-5.0	2.7	-1.6	19.4	19.8	5.9	8.8	2.4	-5	-10.3	1.8	7.5	-2.4	-8.1	5.0
PC6	4.8	150.4	119.2	174.2	75.6	143.0	35.9	58.0	-16.3	-2	-19.2	-29.2	152.0	136.0	129.0	148.7	158.0	24.3

FLECTIONAL SUBDIVISIONS - DIRECTIONS
 DIRECTIONS (DEGREES FROM C.A.S.C.) BETWEEN SUBDIVISIONS

ORIGIN S/C	DESTINATION S/D																	
	752	753	754	755	756	771	772	773	774	775	776	781	782	783	784	785	786	791
711	159.6	-127.4	149.3	-109.0	107.4	112.0	141.1	120.7	93.5	91.2	128.3	23.6	65.3	43.5	44.6	.6	55.6	115.8
712	14.3	36.0	7.5	24.2	5.6	-7.5	4.8	-2.2	-16.0	-12.6	-1.8	-45.3	-36.3	-48.0	-31.9	-38.9	-19.2	-10.5
713	28.5	51.6	18.7	37.6	17.7	.9	18.5	5.3	-7.9	-6.3	9.8	-44.4	-27.8	-41.1	-29.2	-47.1	-17.0	2.4
714	5.2	33.3	0.0	24.3	5.6	-19.4	-5.0	-9.5	-25.7	-20.3	-11.6	-58.4	-49.7	-83.3	-41.8	-44.4	-25.5	-22.5
715	48.4	41.0	36.1	77.8	32.6	14.0	36.8	16.8	7.0	1.8	25.7	-45.5	-19.6	-35.9	-27.5	-57.2	-15.0	17.6
716	13.8	53.5	6.4	51.5	12.7	-17.7	.8	-7.0	-27.6	-23.4	-7.4	-80.7	-54.6	-72.8	-50.5	-93.8	-36.5	-18.7
722	31.2	-12.4	18.4	-10.6	5.4	29.9	43.5	12.6	19.2	13.5	29.7	2.4	17.7	10.0	7.3	-3.5	7.1	41.1
724	42.0	-3.3	25.6	-7.0	11.3	24.9	44.7	14.9	16.8	12.5	31.7	-4.9	10.5	1.6	2.0	-10.3	4.2	36.2
730	-8.1	-9.1	-2.8	-5.8	-2.8	6.3	-2.3	1.3	7.7	5.0	2.3	8.8	15.5	14.3	8.5	5.0	5.4	11.4
731	-4.5	-14.8	2.0	-12.5	-3.0	24.1	25.2	7.2	21.0	13.7	20.4	12.6	28.5	22.5	14.8	5.5	10.7	48.8
732	-29.1	-18.2	-10.0	-11.4	-7.3	15.1	-21.4	1.4	17.9	14.9	2.9	17.8	33.8	28.9	17.8	10.3	11.4	42.0
736	-12.0	-9.1	-5.4	-5.6	-4.1	2.4	-10.0	-5	5.9	3.4	-2.4	10.4	15.7	15.9	9.1	6.6	5.3	4.4
741	7.7	11.3	3.4	7.4	3.0	-3.1	3.4	-2	-5.6	-4.0	.3	-12.7	-14.0	-16.9	-9.9	-8.7	-5.8	-3.8
742	10.9	29.7	11.2	19.8	10.2	-1.9	11.7	2.0	-7.9	-6.1	4.7	-30.8	-23.8	-32.9	-21.3	-27.0	-12.2	-1.4
743	10.0	22.1	11.5	13.2	5.0	1.4	13.4	3.3	-4.0	-3.0	7.1	-22.3	-16.6	-24.0	-15.0	-19.6	-8.2	2.8
744	10.7	16.3	5.7	10.8	5.4	-3.4	5.6	.1	-7.0	-5.1	1.0	-18.3	-18.1	-22.9	-13.7	-13.2	-7.9	-4.0
745	8.6	17.4	4.0	12.6	4.8	-0.5	2.5	-1.6	-10.0	-7.4	-1.8	-21.2	-22.7	-27.6	-16.5	-14.1	-9.8	-8.1
751	127.4	-102.2	97.4	-62.3	46.6	72.6	110.3	54.9	53.9	44.4	89.2	7.0	38.7	22.1	19.7	-7.5	22.3	85.9
752	-11.0	-34.2	14.3	-22.2	-4.1	53.3	114.4	17.6	39.8	26.5	61.9	17.3	42.7	31.1	22.5	6.7	18.0	89.1
753	70.3	-77.5	56.1	-27.5	32.6	41.1	69.8	31.5	27.6	22.4	52.5	-11.4	13.4	-7	.9	-21.9	6.2	51.3
754	-157.0	-48.7	-2.3	-31.6	-16.3	92.7	161.4	30.2	65.3	44.5	121.5	27.0	61.2	45.0	34.6	12.8	28.7	122.7
755	76.2	137.4	58.1	-92.6	45.8	30.9	64.0	33.2	23.0	19.6	49.4	-22.9	4.4	-11.4	-7.6	-35.4	.8	44.1
756	166.4	-88.4	146.0	-61.6	-20.0	103.9	144.5	95.1	80.5	68.1	124.3	24.2	61.5	42.8	31.9	6.8	38.6	116.1
771	-81.4	-27.6	-51.2	-16.7	-22.3	35.8	6.9	6.7	30.8	14.8	25.7	20.5	43.5	34.3	22.8	10.9	16.0	88.7
772	-47.7	-25.8	-4.4	-16.5	-8.6	53.4	156.7	21.5	114.7	89.0	-174.5	49.6	96.2	73.6	60.7	29.9	51.2	165.6
773	-129.4	-44.5	-126.0	-32.7	-53.4	156.6	-156.7	21.5	114.7	89.0	-174.5	49.6	96.2	73.6	60.7	29.9	51.2	165.6
774	-29.3	-24.0	-61.5	-13.5	-26.6	-110.8	-105.2	-31.9	50.9	-3	-100.9	52.7	109.8	82.5	52.6	34.8	27.3	-144.3
775	-31.7	-24.3	-82.4	-17.0	-41.1	-144.1	-117.3	-61.7	179.6	50.8	-122.3	66.4	128.1	98.4	75.7	44.2	49.0	-151.9
776	-84.7	-31.2	-37.5	-19.6	-17.3	64.6	-142.4	2.4	46.6	25.3	18.4	30.3	62.5	48.7	33.0	17.7	22.6	143.9
791	-27.7	10.1	-26.7	13.7	-11.4	-51.5	-42.4	-27.9	-54.2	-39.9	-44.1	124.0	-95.5	-124.8	-54.1	50.4	-29.4	-62.6
792	-45.1	-7.4	-35.3	-1.8	-16.4	-45.4	-62.2	-24.1	-34.9	-21.5	-54.7	41.7	81.2	73.0	21.1	31.7	2.5	-85.2
793	-74.2	.5	-29.6	4.9	-13.5	-44.8	-48.4	-24.2	-44.7	-28.7	-46.0	34.9	-84.5	103.7	-4.2	32.9	-9.9	-68.4
794	-45.4	-1.0	-42.5	5.6	-21.5	-74.1	-63.5	-40.2	-77.7	-54.5	-64.8	102.5	-139.5	172.7	100.6	63.2	-23.1	-87.8
795	-13.2	24.7	-15.8	26.3	-4.1	-40.5	-26.4	-22.5	-47.0	-37.5	-31.6	-104.5	-80.4	-101.7	-88.3	149.1	-40.2	-46.6
796	-45.3	-10.6	-63.3	-9	-35.7	-104.1	-85.2	-64.6	-117.9	-96.1	-90.1	112.3	-173.0	152.1	142.0	76.4	85.7	-112.5
797	-49.2	-14.5	-23.3	-11.6	-12.2	3.1	-66.5	-4.2	16.5	9.0	-22.8	25.1	45.3	39.6	23.3	16.0	13.5	31.7
792	-56.3	-18.9	-33.8	-10.8	-16.2	-24.5	-79.4	-11.4	4.2	4.3	-49.4	32.1	58.5	50.6	28.2	21.5	14.6	-123.5
793	-57.5	-16.7	-40.1	-8.6	-15.0	-54.6	-79.5	-19.3	-11.6	-5.0	-63.1	39.3	76.2	63.1	32.1	27.2	13.7	-113.6
794	-20.1	-12.2	-4.0	-7.4	-5.8	3.4	-17.4	.8	8.5	5.3	-4.1	14.0	22.6	21.8	12.5	8.9	7.4	7.1
811	-20.2	4.4	-18.7	11.2	-7.4	-37.1	-32.5	-14.6	-36.5	-25.7	-32.4	-7.7	63.5	66.8	-23.1	19.0	-17.0	-49.0
812	-6.6	14.3	-8.6	18.1	-1.0	-26.1	-17.4	-12.7	-29.0	-21.6	-20.2	-38.4	-52.2	-60.8	-33.2	-7.4	-20.4	-32.8
813	-13.5	13.0	-13.5	13.4	-4.3	-30.4	-24.6	-15.1	-31.2	-22.4	-25.4	-21.6	-54.2	-58.0	-28.9	7.3	-17.4	-39.8
814	-10.4	4.8	-9.9	9.7	-3.0	-22.4	-19.4	-10.6	-21.8	-15.3	-19.3	-10.7	-35.8	-32.0	-15.8	3.4	-11.0	-31.2
815	-10.4	20.2	-12.2	20.1	-2.7	-32.4	-22.5	-15.7	-16.1	-27.4	-25.4	-55.0	-64.1	-77.9	-43.3	-2.7	-26.0	-39.6
811	41.4	43.6	28.4	14.3	20.3	15.1	34.9	13.5	5.9	4.7	23.8	-25.8	-9.1	-20.4	-14.1	-30.3	-6.2	20.3
812	68.0	34.1	46.9	-10.9	28.1	34.1	60.4	25.9	22.0	17.6	44.7	-13.9	8.4	-4.7	-2.2	-22.8	3.3	43.6
813	22.7	44.8	21.7	26.6	17.6	0.8	24.6	8.4	-1.6	-1.3	15.1	-33.4	-18.6	-30.4	-20.9	-35.7	-11.2	9.7
814	22.6	21.7	14.0	11.7	10.1	4.6	18.0	5.2	-1.2	-4.8	10.5	-20.7	-13.1	-20.9	-13.2	-19.6	-6.8	7.2
823	2.2	9.9	0.0	7.3	1.6	-7.4	-2.6	-2.7	-8.7	-6.2	-4.6	-11.1	-16.5	-17.7	-10.1	-5.5	-6.4	-10.2
824	4.5	7.8	3.4	4.9	2.8	-1.6	3.4	.2	-3.6	-2.5	1.0	-8.9	-9.7	-11.8	-0.9	-6.2	-4.0	-1.9
826	4.0	51.8	-2.7	55.5	7.4	-31.0	-10.8	-17.1	-42.4	-37.5	-19.3	-109.0	-73.2	-94.4	-74.8	-135.6	-55.4	-32.2

ELFECTORAL SUBDIVISIONS - DIRECTIONS

DIRECTIONS (DEGREES FROM C.H.C.) BETWEEN SUBDIVISIONS

ORIGIN	792	793	794	801	802	803	804	805	811	812	813	814	823	824	PCG
711	102.6	84.5	122.4	20.1	-5.7	8.5	8.0	-6	-90.1	-121.2	-73.2	-75.1	-27.6	-53.7	-19.3
712	-17.1	-22.9	-8.2	-65.9	-84.7	-78.7	-97.0	-64.5	66.3	43.4	72.6	120.2	-157.0	168.6	-8.6
713	-5.7	-12.9	7.5	-59.7	-80.0	-71.4	-83.3	-66.0	101.5	62.3	131.0	159.7	-133.9	-166.8	-19.4
714	-28.9	-34.4	-22.0	-86.7	-115.4	-104.5	-122.7	-84.4	64.0	40.2	73.8	104.0	179.7	148.6	-2.0
715	7.4	-1.9	24.7	-56.3	-75.6	-68.1	-74.7	-69.6	161.8	106.5	-167.1	-170.7	-117.6	-147.3	-40.2
716	-27.4	-35.7	-15.5	-94.7	-130.9	-114.4	-122.3	-116.8	94.7	62.6	115.6	129.7	-168.6	162.2	-23.0
722	31.9	25.2	65.9	1.7	-8.0	-2.9	-3.9	-5.2	-27.5	-18.4	-24.9	-42.0	-28.5	-51.4	-4.7
724	27.2	20.1	53.4	-4.4	-19.9	-14.0	-17.8	-14.5	-37.3	-10.0	-33.2	-61.3	-48.9	-76.5	-8.1
730	13.0	13.4	26.7	12.4	7.3	11.1	15.1	6.9	-9.1	-10.3	-6.7	-10.4	6.1	-6.9	1.1
731	30.9	32.8	103.1	16.1	6.4	12.5	15.6	7.1	-20.6	-21.8	-15.8	-24.1	-2.4	-21.2	0.0
732	36.6	33.3	198.4	23.9	14.3	20.9	26.5	13.8	-15.3	-19.4	-9.9	-14.7	11.5	-5.9	2.7
736	9.1	11.4	1.9	15.2	10.4	14.3	19.7	9.4	-7.4	-10.0	-4.2	-6.8	12.5	.5	2.0
741	-6.8	-9.0	-2.8	-20.1	-16.9	-21.5	-34.0	-13.6	13.9	13.3	9.6	23.8	-84.9	165.2	-2.3
742	-7.5	-12.7	2.3	-45.7	-55.0	-54.2	-71.4	-42.4	44.3	35.7	34.2	123.9	-133.0	-173.1	-8.7
743	-2.8	-7.4	7.3	-33.6	-38.9	-39.6	-54.5	-30.3	25.1	26.1	10.2	83.2	-121.7	-158.9	-7.2
744	-7.9	-11.1	-2.2	-28.8	-27.1	-32.1	-49.2	-21.2	21.4	19.3	14.0	44.2	-121.4	175.2	-3.5
745	-12.0	-15.2	-7.5	-33.9	-30.2	-37.5	-59.2	-23.4	24.9	21.5	21.9	58.0	-145.8	160.7	-3.0
751	70.9	57.7	100.1	5.0	-14.3	-3.8	-4.8	-9.8	-79.1	-103.2	-64.0	-76.2	-37.7	-63.6	-14.1
752	68.5	54.8	123.1	20.3	6.5	14.7	17.1	8.1	-33.3	-38.5	-25.5	-35.5	-6.7	-28.6	-4.9
753	30.4	29.1	64.5	-16.6	-34.1	-25.3	-29.2	-27.8	-98.1	-138.9	-79.9	-102.9	-65.5	-93.8	-19.6
754	90.7	80.9	142.9	30.5	13.2	23.4	26.3	15.0	-34.1	-50.9	-27.8	-35.4	.2	-23.0	1.1
755	32.4	22.1	54.2	-29.9	-50.4	-40.0	-44.4	-43.0	-138.5	161.0	-113.2	-128.0	-83.2	-111.8	-31.0
756	90.6	84.3	128.4	24.1	3.1	14.9	15.5	6.8	-63.9	-87.4	-49.6	-57.0	-16.3	-41.3	-6.0
771	145.1	102.5	-169.1	44.2	31.8	42.6	49.9	30.9	-15.3	-27.6	-6.6	-8.7	28.5	8.1	8.9
772	67.3	50.7	143.7	25.9	13.6	21.5	26.0	13.9	-22.4	-28.2	-15.7	-22.2	6.4	-13.3	2.2
773	145.9	125.5	174.9	54.4	32.9	45.6	49.4	34.3	-29.2	-48.1	-17.3	-20.4	20.5	-2.4	10.5
774	-164.1	162.8	-166.4	65.9	44.0	58.9	67.6	44.3	-7.4	-22.6	2.1	2.6	44.3	23.2	14.6
775	-160.1	169.1	-149.7	74.6	53.3	67.6	74.0	52.9	-4.7	-27.1	2.3	2.9	46.7	24.2	19.4
776	104.3	78.6	164.5	37.5	22.3	32.0	37.8	25.3	-27.0	-32.4	-13.7	-18.2	15.9	-4.7	5.2
781	-68.1	-73.4	-67.8	167.8	135.7	141.6	151.4	98.5	34.0	14.6	43.4	56.2	115.0	91.0	21.1
782	-84.5	-74.3	-102.0	69.2	53.1	66.2	83.9	46.6	7.4	15.6	15.4	21.0	66.4	47.4	14.1
783	-69.9	-69.9	-80.3	88.4	67.0	84.9	110.2	55.3	14.6	3.5	26.1	35.7	88.1	67.8	15.4
784	-95.4	-104.0	-92.7	127.0	91.5	112.9	123.3	48.8	22.3	2.9	32.5	40.3	92.6	69.6	20.9
785	-53.6	-60.4	-47.8	-140.4	145.4	-164.4	-164.0	175.9	54.6	30.8	66.2	82.4	145.7	118.8	19.6
786	-123.9	-137.3	-112.7	129.2	49.4	107.5	113.2	49.2	15.3	-4.5	27.3	31.8	81.4	57.6	30.4
791	44.0	41.4	-167.0	34.2	23.0	31.1	39.0	21.6	-12.2	-20.2	-5.8	-8.2	23.6	5.7	5.6
792	44.2	50.7	-147.3	44.3	31.4	40.8	50.6	24.1	-8.4	-18.8	-1.2	-1.7	34.3	15.9	8.4
793	-116.4	56.7	-131.4	55.4	40.4	51.4	63.1	37.1	-3.4	-15.7	4.3	5.9	45.6	26.6	11.4
794	14.3	17.2	25.0	20.1	13.6	18.7	25.0	12.4	-9.4	-13.2	-5.2	-8.1	15.5	1.1	2.8
801	-51.4	-52.8	-57.2	124.5	72.7	103.7	148.0	45.6	24.7	13.2	35.2	50.6	112.8	90.5	11.9
802	-36.9	-40.4	-36.3	-79.9	155.9	-104.8	-146.4	-19.9	41.1	24.2	46.8	71.3	148.3	120.2	5.9
803	-42.6	-44.5	-46.3	-64.0	60.1	140.8	177.9	22.1	32.2	17.1	37.8	56.8	126.1	102.0	8.6
804	-32.1	-32.1	-39.3	-19.0	19.2	-1.4	141.5	7.9	23.9	13.0	27.0	44.8	114.2	94.5	5.3
805	-44.8	-49.1	-42.9	-112.4	154.7	-148.2	-163.1	150.5	44.9	25.4	52.6	73.9	143.9	116.9	10.0
811	11.4	4.1	29.0	-35.6	-50.6	-44.4	-53.4	-41.4	-115.8	54.5	-76.1	-144.4	-98.1	-131.4	-17.2
812	32.5	23.1	56.5	-14.9	-36.2	-28.2	-33.0	-29.6	-94.2	-84.5	-76.8	-106.3	-70.4	-99.5	-18.3
813	1.4	-5.2	16.2	-44.1	-61.9	-53.8	-67.3	-50.4	84.9	54.9	-132.8	-179.8	-117.2	-151.7	-10.6
814	1.2	-3.7	13.2	-30.8	-37.5	-30.9	-49.6	-29.5	25.3	.1	-132.9	-101.6	-145.1	-8.2	-4.4
823	-12.0	-13.2	-12.4	-17.8	-9.7	-10.8	-29.4	-4.7	15.6	12.0	13.8	29.2	177.8	111.2	-4.4
824	-4.2	-6.0	-4.4	-13.9	-11.6	-14.7	-22.9	-9.5	8.5	6.1	5.2	11.9	-42.6	-155.9	-1.8
PCG	-41.4	-51.4	-29.1	-122.7	-156.1	-138.3	-142.3	-144.6	92.5	60.1	110.1	118.6	175.6	148.0	173.9

APPENDIX H

Summary cross tabulation showing number of electoral
out-transfers by distance and direction with reference
to the C.B.D.

DISTANCES BY DIRECTION BY TRANSFER NUMBERS

(C.B.D. = 0 DEG)

DISTANCE (KM)	DIRECTION (DEGREES)																							
	2	6	10	14	18	22	26	30	34	38	42	46	50	54	58	62	66	70	74	78	82	86	90	94
.5	0	0	0	0	0	0	0	0	0	0	0	0	0	0	0	0	0	0	0	0	0	0	0	0
1.5	0	0	0	0	0	0	0	0	0	0	0	0	0	0	0	0	0	0	0	0	0	0	0	0
2.5	0	0	0	0	0	21	0	78	0	0	189	242	0	0	0	35	165	96	0	74	0	43	157	0
3.5	18	82	334	81	20	59	23	0	46	143	0	224	15	208	0	33	48	0	71	15	0	0	70	0
4.5	149	19	77	0	107	27	17	0	26	211	12	44	75	91	0	38	0	16	29	22	0	0	0	61
5.5	78	91	0	0	78	65	34	96	71	104	57	0	78	1	55	38	14	24	24	22	74	10	39	0
6.5	15	209	11	21	98	53	74	137	5	30	1	94	2	13	0	18	55	4	35	0	24	0	37	0
7.5	34	124	72	19	50	62	3	38	79	31	35	54	20	35	41	54	0	41	30	33	0	14	36	36
8.5	27	130	13	35	21	20	21	12	37	24	16	17	60	12	0	10	36	0	22	0	0	0	0	0
9.5	68	19	47	96	42	51	55	57	29	0	31	28	56	15	18	0	5	45	6	0	0	0	0	0
10.5	64	32	31	27	11	110	29	9	23	25	19	63	6	0	70	0	2	1	0	0	0	44	0	0
11.5	29	24	66	143	24	4	63	4	36	35	26	6	31	72	0	3	10	0	4	13	0	55	0	0
12.5	35	39	33	35	36	42	21	51	31	15	11	0	0	0	11	0	19	39	15	0	29	0	0	0
13.5	66	8	21	42	56	38	0	15	36	0	86	17	4	0	2	38	0	0	0	0	29	0	6	0
14.5	17	71	17	59	44	68	3	40	18	25	22	7	0	3	14	0	21	0	4	3	0	94	7	0
15.5	9	54	48	4	4	11	6	6	3	0	37	16	16	0	84	32	0	79	0	0	0	0	0	0
16.5	54	2	34	14	15	16	4	10	0	0	2	23	72	0	1	25	0	0	0	41	0	8	0	0
17.5	27	23	25	20	0	28	0	13	0	0	23	6	20	0	0	0	0	0	0	0	0	0	0	0
18.5	20	25	35	10	0	0	14	19	39	17	0	45	4	0	19	0	32	0	0	0	0	0	0	0
19.5	4	34	14	1	2	1	4	8	8	0	6	10	10	0	35	0	0	0	0	0	0	0	0	0
20.5	13	10	14	47	13	24	6	0	0	0	16	0	1	0	0	0	0	0	0	0	0	19	0	0
21.5	1	9	0	0	0	5	0	0	0	0	0	0	0	0	0	0	0	0	0	0	0	0	0	0
22.5	37	26	9	3	0	17	6	0	0	0	0	0	0	0	37	0	0	0	0	0	0	0	0	0
23.5	6	15	12	7	8	0	27	0	0	0	0	0	0	0	27	0	0	0	0	0	0	0	11	0
24.5	9	15	13	8	0	9	0	0	0	0	0	0	0	0	0	0	0	0	0	0	0	0	18	0
25.5	7	0	6	16	0	0	1	2	0	0	0	0	0	2	0	0	0	0	0	0	0	0	0	7
26.5	6	35	11	14	12	0	0	46	0	0	0	0	0	0	21	0	9	0	0	8	0	0	5	0
27.5	13	5	4	0	20	0	11	9	0	0	0	0	0	0	0	15	0	0	0	0	0	0	0	0
28.5	12	11	1	1	0	0	6	0	0	0	0	7	0	0	0	2	0	0	0	0	0	0	0	0
29.5	0	4	0	0	0	3	11	0	0	0	0	6	0	0	0	0	0	0	0	0	0	0	0	0
30.5	19	0	3	0	0	0	4	0	0	0	0	0	0	0	1	0	0	0	0	0	0	0	0	0
31.5	0	2	1	4	0	0	2	0	0	0	0	2	0	0	0	0	9	0	0	4	0	0	0	0
32.5	19	6	8	1	0	0	0	7	0	0	0	0	0	0	0	0	0	0	26	0	0	0	0	0
33.5	7	0	0	34	0	0	0	5	8	0	0	0	0	0	0	0	0	0	0	0	0	0	0	0
34.5	3	15	4	0	7	0	3	1	0	0	0	0	0	0	0	0	0	0	0	0	0	0	0	0
35.5	0	0	0	1	0	0	0	0	0	0	24	0	0	0	0	0	0	0	0	0	0	0	0	0
36.5	1	8	6	0	0	8	0	7	0	0	0	0	0	0	0	0	0	0	0	0	0	0	0	0
37.5	0	9	1	0	0	0	0	0	0	0	0	0	0	0	0	0	0	0	0	0	0	0	0	0
38.5	0	0	0	0	0	0	0	0	0	0	0	0	0	0	0	0	0	0	0	0	0	0	0	0
39.5	23	0	0	0	0	0	0	0	0	0	0	0	0	0	0	0	0	0	5	0	0	0	0	0
40.5	1	0	0	0	0	0	0	0	0	0	0	0	0	0	0	0	0	0	0	0	0	0	0	0
41.5	0	0	0	0	0	0	0	0	0	0	0	0	0	0	0	0	0	0	0	0	0	0	0	0
42.5	1	0	0	0	0	5	0	0	0	0	0	1	0	0	0	0	0	0	0	0	0	0	0	0
43.5	0	0	0	0	0	19	0	0	0	0	0	0	0	0	0	0	0	0	0	0	0	0	0	0
44.5	3	0	0	0	0	0	0	0	0	0	0	0	0	0	0	0	0	0	0	0	0	0	0	0
45.5	0	0	0	0	0	0	0	0	0	0	0	0	0	0	0	0	0	0	0	0	0	0	0	0
46.5	0	0	0	0	0	0	0	0	0	0	0	0	0	0	0	0	0	0	0	0	0	0	0	0
47.5	20	0	0	0	0	0	0	0	0	0	0	0	0	0	0	0	0	0	0	0	0	0	0	0
48.5	0	0	0	0	0	0	0	0	0	0	0	0	0	0	0	0	0	0	0	0	0	0	0	0
49.5	0	12	0	0	0	0	0	0	0	0	0	0	0	0	0	0	0	0	0	0	0	0	0	0

DISTANCES BY DIRECTION BY TRANSFER NUMBERS

(C.B.D. = 0 DEG)

DISTANCE (KM)	DIRECTION (DEGREES)																							
	2	6	10	14	18	22	26	30	34	38	42	46	50	54	58	62	66	70	74	78	82	86	90	94
50.5	0	0	0	0	0	0	0	0	0	0	0	0	0	0	0	0	0	0	0	0	0	0	0	0
51.5	0	0	0	0	0	0	0	0	0	0	0	0	0	0	0	0	0	0	0	0	0	0	0	0
52.5	0	0	0	0	0	0	0	0	0	0	0	0	0	0	0	0	0	0	0	0	0	0	0	0
53.5	0	0	0	0	0	0	0	0	0	0	0	0	0	0	0	0	0	0	0	0	0	0	0	0
54.5	0	0	0	0	0	0	0	0	0	0	0	0	0	0	0	0	0	0	0	0	0	0	0	0
55.5	0	0	0	1	0	0	0	0	0	0	0	0	0	0	0	0	0	0	0	0	0	0	0	0
56.5	0	0	0	0	0	0	0	0	0	0	0	0	0	0	0	0	0	0	0	0	0	0	0	0
57.5	0	13	0	0	0	0	0	0	0	0	0	0	0	0	0	0	0	0	0	0	0	0	0	0
58.5	5	2	0	0	0	0	0	0	0	0	0	0	0	0	0	0	0	0	0	0	0	0	0	0
59.5	0	0	0	0	0	0	0	0	0	0	0	0	0	0	0	0	0	0	0	0	0	0	0	0
60.5	0	0	0	0	0	0	0	0	0	0	0	0	0	0	0	0	0	0	0	0	0	0	0	0
61.5	0	0	0	0	0	0	0	0	0	0	0	0	0	0	0	0	0	0	0	0	0	0	0	0
62.5	0	0	0	0	0	0	0	0	0	0	0	0	0	0	0	0	0	0	0	0	0	0	0	0
63.5	0	0	0	0	0	0	0	0	0	0	0	0	0	0	0	0	0	0	0	0	0	0	0	0
64.5	0	0	0	0	0	0	0	0	0	0	0	0	0	0	0	0	0	0	0	0	0	0	0	0
65.5	0	0	0	0	0	0	0	0	0	0	0	0	0	0	0	0	0	0	0	0	0	0	0	0
66.5	0	0	0	0	0	0	0	0	0	0	0	0	0	0	0	0	0	0	0	0	0	0	0	0
67.5	0	0	0	0	0	0	0	0	0	0	0	0	0	0	0	0	0	0	0	0	0	0	0	0
68.5	0	8	0	0	0	0	0	0	0	0	0	0	0	0	0	0	0	0	0	0	0	0	0	0
69.5	0	0	0	0	0	0	0	0	0	0	0	0	0	0	0	0	0	0	0	0	0	0	0	0
TOTAL (ASD)	938	1353	985	890	793	730	645	638	567	592	455	1021	651	550	428	499	457	354	240	248	214	410	286	157
0/0	2.35	3.39	2.47	2.23	1.99	1.83	1.86																	

DISTANCES BY DIRECTION BY TRANSFER NUMBERS

(C.B.D. = 0 DEG)

DISTANCE (KM)	DIRECTION (DEGREES)																							
	-166	-162	-158	-154	-150	-146	-142	-138	-134	-130	-126	-122	-118	-114	-110	-106	-102	-98	-94	-90	-86	-82	-78	-74
.5	0	0	0	0	0	0	0	0	0	0	0	0	0	0	0	0	0	0	0	0	0	0	0	0
1.5	0	0	0	0	0	0	0	0	0	0	0	0	0	0	113	0	0	0	0	0	0	0	0	0
2.5	0	0	0	0	0	0	0	0	0	105	0	233	21	0	53	30	157	42	0	0	0	0	0	0
3.5	68	44	205	0	69	27	21	0	0	56	212	43	16	33	0	187	0	122	12	0	61	0	111	0
4.5	68	0	0	0	0	0	24	141	0	0	2	28	8	0	0	45	7	0	79	0	0	12	67	15
5.5	68	0	0	0	0	0	2	0	0	0	0	53	48	134	0	46	44	27	3	10	33	11	35	0
6.5	0	21	0	0	0	144	0	29	0	41	17	0	0	0	0	24	40	8	0	0	25	54	49	35
7.5	0	29	13	0	0	0	18	0	0	31	0	28	0	28	0	9	0	101	0	57	0	0	93	14
8.5	0	35	0	0	39	17	0	0	0	0	0	0	3	30	28	0	29	0	44	0	32	9	35	58
9.5	253	0	0	0	0	0	15	0	0	9	0	0	0	0	0	0	0	0	5	0	12	0	20	0
10.5	0	0	17	0	0	10	0	0	0	0	20	30	0	44	0	59	0	0	0	0	11	0	0	0
11.5	0	0	0	0	0	0	0	0	0	49	0	0	40	0	0	2	35	0	0	0	26	0	13	0
12.5	0	15	0	0	0	204	0	40	17	0	0	32	15	0	0	4	0	4	0	10	3	0	0	0
13.5	0	0	0	0	0	13	0	0	0	0	0	0	24	0	0	0	0	0	0	0	10	52	14	0
14.5	0	0	0	0	0	0	0	0	0	0	0	0	0	0	0	0	30	0	0	0	9	12	0	0
15.5	0	1	0	0	0	0	13	0	0	99	0	0	0	0	0	0	0	19	0	0	0	0	13	5
16.5	8	0	0	0	0	50	0	0	0	0	0	0	0	0	0	0	0	0	0	0	0	0	0	16
17.5	0	0	0	0	0	0	0	0	0	0	0	0	0	0	0	0	0	0	0	0	6	0	0	0
18.5	0	0	0	0	0	0	0	0	0	0	0	0	0	0	0	0	0	0	0	0	0	0	0	0
19.5	0	0	0	0	0	40	0	0	0	0	0	0	0	0	0	0	0	0	0	0	0	0	0	0
20.5	0	0	0	0	0	0	13	0	0	0	0	0	0	0	0	0	0	0	0	0	0	0	0	0
21.5	0	0	13	0	12	0	0	0	0	0	0	0	0	33	0	0	0	0	0	0	0	47	0	0
22.5	0	0	0	0	0	31	0	0	0	8	0	0	0	5	0	0	0	0	0	0	0	0	0	0
23.5	0	0	0	0	0	0	5	4	0	0	0	0	0	0	0	0	0	0	0	0	0	0	0	0
24.5	0	0	0	0	0	0	0	0	19	0	0	0	0	0	0	7	0	8	0	0	0	0	0	0
25.5	0	0	0	0	18	13	0	0	0	0	0	2	0	0	0	0	0	0	6	0	0	0	0	0
26.5	0	0	0	0	3	0	0	0	0	0	12	0	0	0	0	0	0	0	0	0	0	0	0	0
27.5	0	0	0	0	0	0	0	0	6	0	0	0	0	0	0	0	0	0	0	0	0	8	0	0
28.5	0	0	0	0	0	0	0	0	7	0	0	0	5	0	0	0	0	0	0	0	0	0	0	0
29.5	0	0	0	0	0	0	0	0	0	0	0	0	0	0	0	0	0	0	0	0	0	0	0	0
30.5	0	0	0	0	2	0	0	0	0	0	0	0	0	0	0	0	0	2	0	0	0	0	0	0
31.5	2	0	0	0	0	0	0	0	0	6	0	0	0	0	0	0	6	0	0	0	0	24	0	0
32.5	0	0	0	0	0	0	0	0	0	0	0	0	0	0	0	0	0	0	0	0	0	0	0	14
33.5	0	0	0	0	0	0	0	0	0	0	0	0	0	0	0	0	0	0	0	0	0	0	0	0
34.5	0	0	0	0	0	1	0	0	0	0	0	0	0	0	0	0	0	0	0	0	0	0	0	0
35.5	0	0	0	0	0	0	0	0	0	0	0	0	0	0	7	0	0	0	0	0	0	0	0	0
36.5	0	0	0	0	0	0	0	0	0	0	0	0	0	0	0	0	0	0	0	0	0	0	0	0
37.5	0	0	0	0	0	0	0	0	0	0	0	0	0	0	0	0	0	0	0	0	0	0	0	0
38.5	0	0	0	0	0	0	0	0	0	0	0	0	0	0	0	0	0	0	0	0	0	0	0	0
39.5	0	0	0	0	0	0	0	0	0	0	0	0	0	0	0	0	0	0	0	0	0	0	0	0
40.5	0	0	0	0	0	0	0	0	0	0	0	0	0	0	0	0	0	0	0	0	0	0	0	0
41.5	0	0	0	0	0	0	0	0	0	0	0	0	0	0	0	0	0	0	0	0	0	0	0	0
42.5	0	0	0	0	0	0	0	0	0	0	0	0	0	0	0	0	0	0	0	0	0	0	0	0
43.5	0	0	0	0	0	0	0	0	0	0	0	0	0	0	0	0	0	0	0	0	0	0	0	0
44.5	0	0	0	0	0	0	0	0	0	0	0	0	0	0	0	0	0	0	0	0	0	0	0	0
45.5	0	0	0	0	0	0	0	0	0	0	0	0	0	0	0	0	0	0	0	0	0	0	0	0
46.5	0	0	0	0	0	0	0	0	0	0	0	0	0	0	0	0	0	0	0	0	0	0	0	0
47.5	0	0	0	0	0	0	0	0	0	0	0	0	0	0	0	0	0	0	0	0	0	0	0	0
48.5	0	0	0	0	0	0	0	0	0	0	0	0	0	0	0	0	0	0	0	0	0	0	0	0
49.5	0	0	0	0	0	0	0	0	0	0	0	0	0	0	0	0	0	0	0	0	0	0	0	0

DISTANCES BY DIRECTION BY TRANSFER NUMBERS

(C.B.D. = 0 DEG)

DISTANCE (KM)	DIRECTION (DEGREES)																							
	-166	-162	-158	-154	-150	-146	-142	-138	-134	-130	-126	-122	-118	-114	-110	-106	-102	-98	-94	-90	-86	-82	-78	-74
50.5	0	0	0	0	0	0	0	0	0	0	0	0	0	0	0	0	0	0	0	0	0	0	0	0
51.5	0	0	0	0	0	0	0	0	0	0	0	0	0	0	0	0	0	0	0	0	0	0	0	0
52.5	0	0	0	0	0	0	0	0	0	0	0	0	0	0	0	0	0	0	0	0	0	0	0	0
53.5	0	0	0	0	0	0	0	0	0	0	0	0	0	0	0	0	0	0	0	0	0	0	0	0
54.5	0	0	0	0	0	0	0	0	0	0	0	0	0	0	0	0	0	0	0	0	0	0	0	0
55.5	0	0	0	0	0	0	0	0	0	0	0	0	0	0	0	0	0	0	0	0	0	0	0	0
56.5	0	0	0	0	0	0	0	0	0	0	0	0	0	0	0	0	0	0	0	0	0	0	0	0
57.5	0	0	0	0	0	0	0	0	0	0	0	0	0	0	0	0	0	0	0	0	0	0	0	0
58.5	0	0	0	0	0	0	0	0	0	0	0	0	0	0	0	0	0	0	0	0	0	0	0	0
59.5	0	0	0	0	0	0	0	0	0	0	0	0	0	0	0	0	0	0	0	0	0	0	0	0
60.5	0	0	0	0	0	0	0	0	0	0	0	0	0	0	0	0	0	0	0	0	0	0	0	0
61.5	0	0	0	0	0	0	0	0	0	0	0	0	0	0	0	0	0	0	0	0	0	0	0	0
62.5	0	0	0	0	0	0	0	0	0	0	0	0	0	0	0	0	0	0	0	0	0	0	0	0
63.5	0	0	0	0	0	0	0	0	0	0	0	0	0	0	0	0	0	0	0	0	0	0	0	0
64.5	0	0	0	0	0	0	0	0	0	0	0	0	0	0	0	0	0	0	0	0	0	0	0	0
65.5	0	0	0	0	0	0	0	0	0	0	0	0	0	0	0	0	0	0	0	0	0	0	0	0
66.5	0	0	0	0	0	0	0	0	0	0	0	0	0	0	0	0	0	0	0	0	0	0	0	0
67.5	0	0	0	0	0	0	0	0	0	0	0	0	0	0	0	0	0	0	0	0	0	0	0	0
68.5	0	0	0	0	0	0	0	0	0	0	0	0	0	0	0	0	0	0	0	0	0	0	0	0
69.5	0	0	0	0	0	0	0	0	0	0	0	0	0	0	0	0	0	0	0	0	0	0	0	0
TOTAL	487	145	248	0	714	529	115	292	66	234	200	414	421	311	187	198	450	382	304	168	284	192	532	194
(ASD) 0/0	1.22	.36	.62	0.00	.54	1.32	.29	.73	.17	.59	.50	1.04	1.05	.78	.45	.50	1.13	.96	.76	.42	.71	.48	1.33	.49

APPENDIX I

Summary cross tabulation showing number of electoral
out-transfers by distance and direction with reference
to north.

DISTANCES BY DIRECTION BY TRANSFER NUMBERS
(NCRTH = 0 DEG.)

DISTANCE (KM)	DIRECTION (DEGREES)																							
	2	6	10	14	18	22	26	30	34	38	42	46	50	54	58	62	66	70	74	78	82	86	90	94
.5	0	0	0	0	0	0	0	0	0	0	0	0	0	0	0	0	0	0	0	0	0	0	0	0
1.5	0	0	0	0	0	0	0	0	0	0	0	0	31	0	0	0	0	0	0	0	0	0	0	0
2.5	25	0	0	37	99	0	101	0	0	0	0	0	0	0	39	0	0	0	0	0	0	21	113	0
3.5	45	0	163	160	0	83	12	21	0	186	122	0	0	0	0	0	0	0	0	0	0	0	0	0
4.5	43	0	22	2	68	43	0	81	77	1	0	100	0	0	0	43	0	5	94	0	0	52	13	59
5.5	6	0	28	11	78	33	0	11	30	7	0	33	0	52	14	34	85	22	40	0	0	61	48	0
6.5	0	251	50	74	0	0	0	44	171	0	64	6	96	20	47	24	0	25	0	25	0	49	60	0
7.5	9	17	5	299	60	29	0	23	72	98	14	60	65	114	38	51	18	38	0	57	68	0	16	0
8.5	60	0	75	37	44	54	0	16	58	0	26	8	1	9	36	24	23	22	53	66	44	24	0	45
9.5	0	19	20	4	111	0	0	32	30	0	27	1	16	37	4	14	37	0	0	2	12	0	0	3
10.5	12	11	12	8	27	112	0	70	98	35	13	40	98	49	0	0	13	46	51	65	21	3	0	14
11.5	7	0	68	24	6	11	42	0	126	23	59	4	26	0	84	42	24	2	3	50	67	0	0	5
12.5	3	36	104	62	14	13	30	3	100	0	0	0	80	20	7	0	0	8	35	4	16	0	0	3
13.5	44	10	12	3	4	0	19	53	8	0	0	25	7	0	18	8	29	0	43	32	0	30	0	1
14.5	0	0	29	19	26	0	23	20	20	21	5	58	23	36	0	0	63	0	0	0	0	0	0	4
15.5	20	0	42	8	20	18	2	33	18	0	20	0	0	18	0	0	37	0	58	0	1	7	62	1
16.5	17	0	5	0	0	11	15	10	73	0	33	39	41	13	0	0	0	0	0	0	0	0	0	32
17.5	0	3	0	0	0	0	0	0	0	0	0	0	0	0	0	23	0	0	0	0	0	0	0	0
18.5	16	2	7	0	0	35	45	0	0	2	39	0	0	0	0	0	0	50	0	0	0	4	0	0
19.5	0	4	29	9	0	17	28	35	36	16	16	0	20	0	0	0	0	0	0	0	0	0	0	0
20.5	0	0	1	16	23	7	39	1	29	49	23	35	0	4	0	0	0	0	0	0	0	0	0	0
21.5	0	37	12	21	0	18	23	19	10	0	0	0	0	0	0	5	0	0	0	0	0	0	0	0
22.5	0	0	0	7	8	33	0	11	7	0	18	0	0	0	0	0	0	0	0	0	0	0	0	0
23.5	5	0	3	13	9	0	0	20	9	10	23	0	0	0	0	0	0	0	0	0	0	0	0	0
24.5	0	6	4	7	3	5	8	13	0	20	0	0	0	0	0	0	0	0	0	0	0	0	0	0
25.5	0	10	0	24	0	12	0	22	0	15	0	0	0	2	0	0	0	0	0	0	0	0	0	0
26.5	0	0	10	8	3	0	0	0	0	0	0	0	0	0	0	0	0	0	0	0	0	0	0	0
27.5	6	18	0	15	2	11	0	26	0	23	23	0	1	0	0	0	0	0	0	0	0	0	0	0
28.5	0	3	4	0	14	3	0	4	0	15	0	0	0	0	0	0	0	0	0	0	0	0	0	0
29.5	0	7	1	3	17	0	11	0	0	0	0	0	0	0	0	0	0	0	0	0	0	0	0	0
30.5	14	4	0	0	2	0	4	6	0	0	0	0	0	0	0	0	0	0	0	0	0	0	0	0
31.5	0	0	3	0	8	0	0	0	1	0	0	0	0	0	0	0	0	0	0	0	0	0	0	0
32.5	1	0	4	0	14	11	9	5	2	6	0	9	0	0	0	0	0	0	0	0	0	0	0	0
33.5	0	0	5	0	0	1	0	2	9	0	0	0	0	0	0	0	0	0	0	0	0	0	0	0
34.5	0	0	3	9	7	7	13	2	0	0	0	0	0	0	0	0	0	0	0	0	0	0	0	0
35.5	0	0	0	0	0	1	1	1	2	0	0	0	0	0	0	0	0	0	0	0	0	0	0	0
36.5	0	0	0	0	0	0	0	0	0	0	0	0	0	0	0	0	0	0	0	0	0	0	0	0
37.5	1	2	3	3	3	13	0	0	0	0	0	0	0	0	0	0	0	0	0	0	0	0	0	0
38.5	1	0	0	0	7	0	0	5	0	0	0	0	0	0	0	0	0	0	0	0	0	0	0	0
39.5	0	0	2	0	0	16	0	0	0	5	0	0	0	0	0	0	0	0	0	0	0	0	0	0
40.5	0	0	1	0	0	1	3	0	0	0	0	0	0	0	0	0	0	0	0	0	0	0	0	0
41.5	0	0	0	0	0	0	0	0	0	0	0	0	0	0	0	0	0	0	0	0	0	0	0	0
42.5	0	0	0	0	0	0	5	2	1	0	0	0	0	0	0	0	0	0	0	0	0	0	0	0
43.5	0	0	0	0	0	2	0	0	0	0	0	0	0	0	0	0	0	0	0	0	0	0	0	0
44.5	0	0	0	0	0	4	0	0	0	0	0	0	0	0	0	0	0	0	0	0	0	0	0	0
45.5	0	0	0	0	0	0	0	0	0	0	0	0	0	0	0	0	0	0	0	0	0	0	0	0
46.5	0	0	0	0	0	0	0	6	0	0	0	0	0	0	0	0	0	0	0	0	0	0	0	0
47.5	0	0	12	0	0	7	0	0	0	0	0	0	0	0	0	0	0	0	0	0	0	0	0	0
48.5	0	0	0	0	0	0	0	0	0	0	0	0	0	0	0	0	0	0	0	0	0	0	0	0
49.5	0	0	0	0	0	0	0	0	0	0	0	0	0	0	0	0	0	0	0	0	0	0	0	0

DISTANCES BY DIRECTION BY TRANSFER NUMBERS
(NCRTH = 0 DEG.)

DISTANCE (KM)	DIRECTION (DEGREES)																							
	2	6	10	14	18	22	26	30	34	38	42	46	50	54	58	62	66	70	74	78	82	86	90	94
50.5	0	0	0	0	0	0	0	0	0	0	0	0	0	0	0	0	0	0	0	0	0	0	0	0
51.5	0	0	0	0	0	0	0	0	0	0	0	0	0	0	0	0	0	0	0	0	0	0	0	0
52.5	0	0	0	0	0	0	0	0	0	0	0	0	0	0	0	0	0	0	0	0	0	0	0	0
53.5	0	0	0	0	0	0	0	0	0	0	0	0	0	0	0	0	0	0	0	0	0	0	0	0
54.5	0	0	0	1	0	0	0	0	0	0	0	0	0	0	0	0	0	0	0	0	0	0	0	0
55.5	0	0	0	0	0	0	0	0	0	0	0	0	0	0	0	0	0	0	0	0	0	0	0	0
56.5	0	0	0	0	0	0	0	0	0	0	0	0	0	0	0	0	0	0	0	0	0	0	0	0
57.5	0	0	0	0	0	0	0	0	0	0	0	0	0	0	0	0	0	0	0	0	0	0	0	0
58.5	0	2	0	0	0	0	5	0	0	0	0	0	0	0	0	0	0	0	0	0	0	0	0	0
59.5	0	0	0	0	0	0	0	0	0	0	0	0	0	0	0	0	0	0	0	0	0	0	0	0
60.5	0	0	0	0	0	0	0	0	0	0	0	0	0	0	0	0	0	0	0	0	0	0	0	0
61.5	0	0	0	0	0	0	0	0	0	0	0	0	0	0	0	0	0	0	0	0	0	0	0	0
62.5	0	0	0	0	0	0	0	0	0	0	0	0	0	0	0	0	0	0	0	0	0	0	0	0
63.5	0	0	0	0	0	0	0	0	0	0	0	0	0	0	0	0	0	0	0	0	0	0	0	0
64.5	0	0	0	0	0	0	0	0	0	0	0	0	0	0	0	0	0	0	0	0	0	0	0	0
65.5	0	0	0	0	0	0	0	0	0	0	0	0	0	0	0	0	0	0	0	0	0	0	0	0
66.5	0	0	0	0	0	0	0	0	0	0	0	0	0	0	0	0	0	0	0	0	0	0	0	0
67.5	0	0	0	0	0	0	0	0	0	0	0	0	0	0	0	0	0	0	0	0	0	0	0	0
68.5	0	0	0	0	2	0	0	0	0	0	0	0	0	0	0	0	0	0	0	0	0	0	0	0
69.5	0	0	0	0	0	0	0	0	0	0	0	0	0	0	0	0	0	0	0	0	0	0	0	0
TOTAL (ASD)	352	452	740	922	683	670	696	771	790	805	517	720	445	651	508	469	616	483	393	434	354	328	259	192
0/0	.88	1.13	1.65	2.31	1.71	1.68	1.74	1.93	1.98	1.51	1.29	1.80	1.11	1.63	1.26	1.17	1.54	1.21	.98					

DISTANCES BY DIRECTION BY TRANSFER NUMBERS

(NCRTH = 0 DEG.)

DISTANCE (KM)	DIRECTION (DEGREES)																							
	98	102	106	110	114	118	122	126	130	134	138	142	146	150	154	158	162	166	170	174	178	182	186	190
.5	0	0	0	0	0	0	0	0	0	0	0	0	0	0	0	0	0	0	0	0	0	0	0	0
1.5	0	0	0	0	29	0	0	0	0	0	0	0	0	0	0	74	0	0	0	0	0	0	0	0
2.5	0	61	85	0	0	153	0	20	155	0	87	105	26	34	0	53	66	0	167	44	45	0	0	0
3.5	0	0	137	51	72	64	0	0	44	31	0	28	130	0	44	496	0	16	0	16	0	41	0	193
4.5	2	0	56	18	0	34	62	0	12	75	272	0	45	28	0	44	0	0	0	0	28	0	24	0
5.5	14	26	16	12	54	17	0	0	74	0	28	13	34	78	0	15	0	123	72	0	28	0	46	0
6.5	0	33	0	0	73	0	41	75	17	9	0	60	12	0	0	157	108	47	165	15	0	66	79	0
7.5	17	0	41	1	28	23	14	0	18	0	14	23	31	12	9	0	14	18	29	0	39	16	5	0
8.5	8	38	5	2	27	0	0	23	27	46	4	61	0	8	34	89	0	41	10	16	7	82	0	25
9.5	20	1	13	5	22	21	0	5	24	0	16	15	4	20	42	0	17	44	0	156	0	38	22	0
10.5	28	23	21	6	0	12	24	0	0	0	13	4	16	32	0	0	27	0	33	4	20	18	14	14
11.5	33	11	0	15	36	15	0	4	0	29	0	12	37	26	16	26	0	14	0	18	18	6	4	32
12.5	0	0	1	0	15	0	0	30	38	34	0	2	11	1	0	7	1	50	0	69	22	2	54	178
13.5	27	3	0	29	0	0	0	10	7	0	0	24	9	10	2	17	0	38	0	29	0	14	70	20
14.5	0	64	0	0	0	0	0	16	1	2	16	7	0	0	0	14	7	14	0	68	35	26	0	77
15.5	0	7	0	0	3	0	0	12	0	0	0	0	0	0	11	7	0	14	6	13	0	0	3	28
16.5	0	0	5	0	0	0	2	0	0	0	23	10	0	0	3	2	0	0	0	0	2	34	0	2
17.5	0	0	0	0	5	16	0	0	0	0	0	14	0	0	13	0	17	9	0	11	0	30	6	14
18.5	0	10	0	0	0	0	1	0	0	0	0	0	0	0	0	0	0	0	0	0	2	0	1	17
19.5	45	0	0	0	0	0	0	16	10	0	0	0	12	0	0	0	13	0	0	10	0	2	1	0
20.5	0	0	0	0	0	0	0	0	0	1	0	4	6	0	0	0	0	0	0	7	0	0	0	0
21.5	0	0	12	0	0	6	13	0	0	0	0	0	0	0	0	0	0	7	1	16	31	0	67	13
22.5	0	0	0	0	1	0	0	0	0	0	0	0	13	0	2	0	0	0	0	0	0	0	0	0
23.5	0	0	0	0	0	0	18	0	0	0	0	0	0	0	0	0	0	0	0	0	19	0	9	12
24.5	0	0	0	0	0	0	0	6	0	0	2	0	0	0	0	0	0	0	0	0	0	0	53	0
25.5	0	0	0	0	0	0	0	0	0	7	0	0	0	0	0	0	0	0	3	0	12	0	0	6
26.5	0	0	0	0	0	0	0	10	0	0	0	0	0	0	0	0	3	0	0	0	6	25	0	0
27.5	0	0	0	0	0	0	0	0	0	0	0	0	0	0	0	0	0	0	9	11	0	7	13	0
28.5	0	0	0	0	0	0	0	0	0	0	0	0	0	0	0	0	0	0	0	0	0	0	0	8
29.5	0	0	0	0	0	0	0	0	0	2	0	0	0	0	0	0	0	0	2	0	27	0	0	0
30.5	0	0	0	0	0	0	0	0	0	0	0	0	0	0	0	0	0	0	0	0	0	6	5	0
31.5	0	0	0	0	0	0	0	0	0	0	0	0	0	0	0	0	0	0	0	0	24	0	4	0
32.5	0	0	0	0	0	0	0	0	0	0	0	0	0	0	0	0	0	0	0	0	14	0	0	8
33.5	0	0	0	0	0	0	0	0	0	0	0	0	0	0	0	0	0	0	0	0	1	0	0	0
34.5	0	0	0	0	0	0	0	0	0	0	0	0	0	0	0	0	0	0	3	0	0	4	19	0
35.5	0	0	0	0	0	0	0	0	0	0	0	0	0	0	0	0	0	0	0	4	0	0	0	0
36.5	0	0	0	0	0	0	0	0	0	0	0	0	0	0	0	0	0	0	0	0	0	4	5	0
37.5	0	0	0	0	0	0	0	0	0	0	0	0	0	0	0	0	0	0	0	0	10	3	0	0
38.5	0	0	0	0	0	0	0	0	0	0	0	0	0	0	0	0	0	0	0	0	0	0	0	8
39.5	0	0	0	0	0	0	0	0	0	0	0	0	0	0	0	0	0	0	0	0	0	0	0	0
40.5	0	0	0	0	0	0	0	0	0	0	0	0	0	0	0	0	0	0	0	0	0	0	0	0
41.5	0	0	0	0	0	0	0	0	0	0	0	0	0	0	0	0	0	0	0	0	12	0	0	0
42.5	0	0	0	0	0	0	0	0	0	0	0	0	0	0	0	0	0	0	0	0	0	0	0	0
43.5	0	0	0	0	0	0	0	0	0	0	0	0	0	0	0	0	0	0	0	0	0	0	2	0
44.5	0	0	0	0	0	0	0	0	0	0	0	0	0	0	0	0	0	0	0	0	0	0	0	0
45.5	0	0	0	0	0	0	0	0	0	0	0	0	0	0	0	0	0	0	0	0	0	0	0	0
46.5	0	0	0	0	0	0	0	0	0	0	0	0	0	0	0	0	0	0	0	0	0	0	0	13
47.5	0	0	0	0	0	0	0	0	0	0	0	0	0	0	0	0	0	0	0	0	0	0	0	0
48.5	0	0	0	0	0	0	0	0	0	0	0	0	0	0	0	0	0	0	0	0	0	0	0	0
49.5	0	0	0	0	0	0	0	0	0	0	0	0	0	0	0	0	0	0	0	0	0	0	0	0

DISTANCES BY DIRECTION BY TRANSFER NUMBERS

(NCRTH = 0 DEG.)

DISTANCE (KM)	DIRECTION (DEGREES)																							
	98	102	106	110	114	118	122	126	130	134	138	142	146	150	154	158	162	166	170	174	178	182	186	190
50.5	0	0	0	0	0	0	0	0	0	0	0	0	0	0	0	0	0	0	0	0	0	0	0	0
51.5	0	0	0	0	0	0	0	0	0	0	0	0	0	0	0	0	0	0	0	0	0	0	0	0
52.5	0	0	0	0	0	0	0	0	0	0	0	0	0	0	0	0	0	0	0	0	0	0	0	0
53.5	0	0	0	0	0	0	0	0	0	0	0	0	0	0	0	0	0	0	0	0	0	0	0	0
54.5	0	0	0	0	0	0	0	0	0	0	0	0	0	0	0	0	0	0	0	0	0	0	0	0
55.5	0	0	0	0	0	0	0	0	0	0	0	0	0	0	0	0	0	0	0	0	0	0	0	0
56.5	0	0	0	0	0	0	0	0	0	0	0	0	0	0	0	0	0	0	0	0	0	0	0	0
57.5	0	0	0	0	0	0	0	0	0	0	0	0	0	0	0	0	0	0	0	0	0	0	0	0
58.5	0	0	0	0	0	0	0	0	0	0	0	0	0	0	0	0	0	0	0	0	0	0	0	0
59.5	0	0	0	0	0	0	0	0	0	0	0	0	0	0	0	0	0	0	0	0	0	0	0	0
60.5	0	0	0	0	0	0	0	0	0	0	0	0	0	0	0	0	0	0	0	0	0	0	0	0
61.5	0	0	0	0	0	0	0	0	0	0	0	0	0	0	0	0	0	0	0	0	0	0	0	0
62.5	0	0	0	0	0	0	0	0	0	0	0	0	0	0	0	0	0	0	0	0	0	0	0	0
63.5	0	0	0	0	0	0	0	0	0	0	0	0	0	0	0	0	0	0	0	0	0	0	0	0
64.5	0	0	0	0	0	0	0	0	0	0	0	0	0	0	0	0	0	0	0	0	0	0	0	0
65.5	0	0	0	0	0	0	0	0	0	0	0	0	0	0	0	0	0	0	0	0	0	0	0	0
66.5	0	0	0	0	0	0	0	0	0	0	0	0	0	0	0	0	0	0	0	0	0	0	0	0
67.5	0	0	0	0	0	0	0	0	0	0	0	0	0	0	0	0	0	0	0	0	0	0	0	0
68.5	0	0	0	0	0	0	0	0	0	0	0	0	0	0	0	0	0	0	0	0	0	0	0	0
69.5	0	0	0	0	0	0	0	0	0	0	0	0	0	0	0	0	0	0	0	0	0	0	0	0
TOTAL (ASD) 0/0	194	277	397	147	374	188	523	238	170	484	221	559	240	354	444	230	458	879	288	866	340	563	426	894
	.49	.69	.99	.37	.94	.47	1.32	.60	.43	1.21	.55													

DISTANCES BY DIRECTION BY TRANSFER NUMBERS

(NORTH = 0 DEG.)

DISTANCE (KM)	DIRECTION (DEGREES)																							
	194	198	202	206	210	214	218	222	226	230	234	238	242	246	250	254	258	262	266	270	274	278	282	286
.5	0	0	0	0	0	0	0	0	0	0	0	0	0	0	0	0	0	0	0	0	0	0	0	0
1.5	0	0	0	0	0	0	0	0	0	59	0	0	27	0	0	0	0	0	33	88	0	0	0	0
2.5	21	96	0	136	0	0	0	0	0	0	0	30	0	0	91	88	0	35	0	0	0	0	42	91
3.5	228	0	108	16	17	0	200	100	93	0	123	165	17	197	132	0	23	102	12	0	35	0	0	193
4.5	1	93	44	0	99	44	3	0	89	0	113	0	56	0	6	69	0	0	61	16	59	2	0	38
5.5	13	152	20	0	4	75	3	0	28	0	48	31	11	83	44	33	35	8	29	40	0	11	29	27
6.5	94	0	0	40	90	0	63	13	46	33	40	30	0	0	13	0	21	0	45	34	0	0	25	0
7.5	296	74	35	0	28	65	45	7	36	70	77	18	43	13	35	0	56	57	0	0	12	29	0	29
8.5	52	46	114	0	9	81	0	13	24	4	4	38	27	4	26	25	55	3	0	30	1	20	9	
9.5	18	263	0	60	18	0	25	8	15	22	11	9	32	0	0	8	0	0	0	0	10	12	0	17
10.5	4	37	61	50	101	36	7	53	36	23	0	15	45	12	25	18	2	0	13	1	15	25	14	
11.5	45	5	22	13	0	52	4	53	9	42	0	49	33	14	1	5	37	7	0	13	0	28	10	
12.5	46	23	36	11	8	81	0	0	30	24	2	0	0	0	0	0	0	0	0	0	2	0	0	0
13.5	10	3	0	10	32	2	0	0	19	6	0	17	8	11	0	40	25	0	1	0	4	4	3	0
14.5	17	0	183	61	162	12	11	40	9	17	0	0	41	0	0	0	10	0	33	0	0	0	42	0
15.5	27	20	0	43	1	8	14	6	36	22	23	0	15	7	0	9	3	0	0	0	0	0	0	0
16.5	53	50	7	4	14	6	0	5	0	4	0	14	0	24	0	3	2	14	4	0	0	0	0	4
17.5	0	0	12	7	11	90	0	37	14	6	22	0	0	11	0	0	4	0	0	0	4	0	0	1
18.5	0	0	69	93	0	0	9	15	0	0	0	0	4	0	0	0	0	0	0	0	0	0	12	0
19.5	15	0	1	34	21	14	8	5	0	3	0	1	0	0	19	0	0	4	0	0	0	13	0	0
20.5	16	52	6	16	4	47	18	12	36	0	0	0	0	0	0	0	0	0	0	0	0	0	0	0
21.5	61	0	7	15	9	19	0	0	0	0	0	4	0	0	0	0	0	0	0	0	0	0	0	0
22.5	1	9	47	12	7	9	0	20	0	4	18	0	0	13	0	0	0	0	0	0	0	0	0	0
23.5	19	34	0	0	29	37	8	1	14	0	0	0	0	0	0	0	0	0	0	0	0	0	0	0
24.5	13	22	39	10	27	0	30	0	0	0	0	0	0	0	0	0	0	0	0	0	0	0	0	0
25.5	8	0	8	8	3	21	7	0	0	0	0	0	0	0	0	0	0	0	0	0	0	0	0	0
26.5	23	9	3	1	0	0	0	0	0	2	0	0	0	0	0	0	0	0	0	0	0	0	0	0
27.5	13	21	25	21	41	43	0	5	0	0	0	0	0	0	0	0	0	0	0	0	0	0	0	0
28.5	1	13	13	4	23	0	24	0	0	0	0	0	0	0	0	0	0	0	0	0	0	0	0	0
29.5	6	35	2	13	0	0	0	0	0	0	0	0	0	0	0	0	0	0	0	0	0	0	0	0
30.5	2	2	0	5	0	2	0	0	0	0	0	0	0	0	0	0	0	0	0	0	0	0	0	0
31.5	11	0	3	16	6	0	0	0	0	0	0	0	0	0	0	0	0	0	0	0	0	0	0	0
32.5	0	9	4	2	0	2	0	0	0	0	0	0	0	0	0	0	0	0	0	0	0	0	0	0
33.5	0	17	36	6	10	8	6	0	6	0	0	0	0	0	0	0	0	0	0	0	0	0	0	0
34.5	8	0	7	0	1	26	0	0	0	0	0	0	0	0	0	0	0	0	0	0	0	0	0	0
35.5	4	4	3	19	9	1	0	0	0	0	0	0	0	0	0	0	0	0	0	0	0	0	0	0
36.5	0	0	24	0	0	0	0	0	0	0	0	0	0	0	0	0	0	0	0	0	0	0	0	0
37.5	5	7	31	0	0	0	0	0	0	0	0	0	0	0	0	0	0	0	0	0	0	0	0	0
38.5	0	8	0	0	5	0	0	0	0	0	0	0	0	0	0	0	0	0	0	0	0	0	0	0
39.5	0	0	12	0	0	6	0	0	0	0	0	0	0	0	0	0	0	0	0	0	0	0	0	0
40.5	0	0	1	1	0	0	0	0	0	0	0	0	0	0	0	0	0	0	0	0	0	0	0	0
41.5	8	0	0	0	0	0	0	0	0	0	0	0	0	0	0	0	0	0	0	0	0	0	0	0
42.5	0	0	1	1	2	5	0	0	0	0	0	0	0	0	0	0	0	0	0	0	0	0	0	0
43.5	0	0	19	0	0	0	0	0	0	0	0	0	0	0	0	0	0	0	0	0	0	0	0	0
44.5	0	4	3	2	2	0	0	0	0	0	0	0	0	0	0	0	0	0	0	0	0	0	0	0
45.5	0	1	1	0	0	0	0	0	0	0	0	0	0	0	0	0	0	0	0	0	0	0	0	0
46.5	0	0	0	0	4	0	0	0	0	0	0	0	0	0	0	0	0	0	0	0	0	0	0	0
47.5	0	0	24	0	0	0	0	0	0	0	0	0	0	0	0	0	0	0	0	0	0	0	0	0
48.5	0	0	0	0	0	0	0	0	0	0	0	0	0	0	0	0	0	0	0	0	0	0	0	0
49.5	4	0	0	3	0	0	0	0	0	0	0	0	0	0	0	0	0	0	0	0	0	0	0	0

DISTANCES BY DIRECTION BY TRANSFER NUMBERS

(NORTH = 0 DEG.)

DISTANCE (KM)	DIRECTION (DEGREES)																							
	194	198	202	206	210	214	218	222	226	230	234	238	242	246	250	254	258	262	266	270	274	278	282	286
50.5	0	0	0	0	0	0	0	0	0	0	0	0	0	0	0	0	0	0	0	0	0	0	0	0
51.5	0	0	0	0	0	0	0	0	0	0	0	0	0	0	0	0	0	0	0	0	0	0	0	0
52.5	0	0	0	0	0	0	0	0	0	0	0	0	0	0	0	0	0	0	0	0	0	0	0	0
53.5	0	0	0	0	0	0	0	0	0	0	0	0	0	0	0	0	0	0	0	0	0	0	0	0
54.5	0	0	0	0	0	0	0	0	0	0	0	0	0	0	0	0	0	0	0	0	0	0	0	0
55.5	0	0	4	0	0	0	0	0	0	0	0	0	0	0	0	0	0	0	0	0	0	0	0	0
56.5	0	0	0	0	0	0	0	0	0	0	0	0	0	0	0	0	0	0	0	0	0	0	0	0
57.5	13	0	0	0	0	0	0	0	0	0	0	0	0	0	0	0	0	0	0	0	0	0	0	0
58.5	0	0	0	7	0	0	0	0	0	0	0	0	0	0	0	0	0	0	0	0	0	0	0	0
59.5	0	0	0	0	0	0	0	0	0	0	0	0	0	0	0	0	0	0	0	0	0	0	0	0
60.5	0	0	0	0	0	0	0	0	0	0	0	0	0	0	0	0	0	0	0	0	0	0	0	0
61.5	0	0	0	0	0	0	0	0	0	0	0	0	0	0	0	0	0	0	0	0	0	0	0	0
62.5	0	0	0	0	0	0	0	0	0	0	0	0	0	0	0	0	0	0	0	0	0	0	0	0
63.5	0	0	0	0	0	0	0	0	0	0	0	0	0	0	0	0	0	0	0	0	0	0	0	0
64.5	0	0	0	0	0	0	0	0	0	0	0	0	0	0	0	0	0	0	0	0	0	0	0	0
65.5	0	0	0	0	0	0	0	0	0	0	0	0	0	0	0	0	0	0	0	0	0	0	0	0
66.5	0	0	0	0	0	0	0	0	0	0	0	0	0	0	0	0	0	0	0	0	0	0	0	0
67.5	0	0	0	0	0	0	0	0	0	0	0	0	0	0	0	0	0	0	0	0	0	0	0	0
68.5	0	0	0	0	0	0	0	0	0	0	0	0	0	0	0	0	0	0	0	0	0	0	0	0
69.5	0	0	0	0	0	0	0	0	0	0	0	0	0	0	0	0	0	0	0	0	0	0	0	0
TOTAL (ASD)	1156	1120	1035	740	817	752	447	393	510	354	509	358	421	387	304	270	280	231	200	157	115	208	423	
0/0	2.89	2.80	2.59	1.85	2.05	1.88	1.77																	

BIBLIOGRAPHY

The principal sources used in the original analyses reported in the present work are as follows.

Australian Bureau of Statistics. Census 30 June 1971.

Australian Bureau of Statistics (Dec. 1974) Internal Migration 1969-70 to 1972-73.

Australian Bureau of Statistics (1974). Characteristics of the Population and Dwellings - Local Government Areas, Part 4 South Australia, Bulletin 7.

Commonwealth Bureau of Census and Statistics (1971). Census of Population and Housing Magnetic Tape Summaries of Collector's District Data, Canberra.

Commonwealth Electoral Act, 1918-1966. 1 July, 1971.

Electoral Act, 1929-1969 (State of South Australia). Reprinted 3 August, 1970.

Report of the Electoral Commission 1969. Parliamentary Paper no. 79, Government Printer, Adelaide.

State Electoral Department, Adelaide, S.A. Various Electoral Data. 16 March, 1970 - 11 June, 1971.

General References

ABLER, R., ADAMS, J.S., and GOULD, P. (1971) Spatial Organization The Geographers View of the World. Prentice-Hall, London.

ADAMS, J.S. (1969) 'Directional Bias in Intra-urban Migration'. Economic Geography, vol. 45, no. 4, pp. 302-323.

ADAMS, J.S. et al (1973) 'Intra-urban Migration'. Annals, Association of American Geographers, vol. 63, no. 1, pp. 152-155.

ADAMS, Russell B. (1969) 'U.S. Metropolitan Migration: Dimensions and Predictability'. Proceedings, Association of American Geographers, vol. 1, pp. 1-6.

- ADELAIDE (1962) Report on the Metropolitan Area of Adelaide.
S.A. Government Printer, Adelaide, S.A.
- AGTERBERG, F.P. and BRIGGS, Garrett (1963) 'Statistical Analysis
of Ripple Marks in Atokan and Desmoinesian Rocks in
the Arkoma Basin of East-Central Oklahoma'.
Journal of Sedimentary Petrology, vol. 33, pp 393-410.
- AITCHISON, D.L.J. (1969) South Australian Year Book, No. 4.
Commonwealth Bureau of Census and Statistics, S.A. Office.
- ALBIG, William (1933) 'The Mobility of Urban Population'. Social
Forces, vol. II, pp. 351-367.
- ALONSO, William (1964) Location and Land Use, Harvard University
Press, Cambridge, Mass.
- BAGLEY, Christopher and BOSHIER, Roger. (1975) 'Demographic
Predictors of Conservatism and Racial Prejudice'.
The Australian and New Zealand Journal of Sociology,
vol. II, no. 2, pp.65-68.
- BERRY, Brian J.L. (1971) 'Introduction: The Logic and Limitations
of Comparative Factorial Ecology'. Economic
Geography, vol. 47, no. 2 (Supplement) pp. 209-219.
- BERRY, Brian J.L. and HORTON, Frank E. (1970) Geographic
Perspectives on Urban Systems with integrated Readings.
Prentice-Hall, New Jersey.
- BERRY, Brian J.L. and SCHWIND, Paul J. (1969) 'Information and
Entropy in Migrant Flows'. Geographical Analysis
vol. I, no. 1, pp. 5-14.
- BLALOCK, Hubert M. (1972) Social Statistics, McGraw-Hill, Tokyo.
- BLALOCK, Hubert M. and BLALOCK, Ann B. (1968) Methodology in Social
Research McGraw-Hill, New York.
- BLUMENFELD, Hans (1949) 'On the Concentric-Circle Theory of Urban
Growth'. Land Economics, vol. 25, pp. 209-212.
- BLUMENFELD, Hans (1954) 'The Tidal Wave of Metropolitan Expansion'
Journal of American Institute of Planners, vol. 20, pp. 3-14.
- BOLWELL, L., CLARKE, B. and STOPPARD, D. (1969) 'Social Class in a New
Town: A Comment'. Urban Studies, vol. 6, no. 1, pp.93-96.
- BOUDON, R. (1968) 'A New Look at Correlation Analysis'. In H.M.Blalock
and A.B. Blalock Methodology in Social Research,
McGraw-Hill, New York.

- BOURNE, Larry S. (1971) (ed.) Internal Structure of the City. Readings on Space and Environment. Oxford University Press, New York.
- BOURNE, Larry S. (1971) 'Physical Adjustment Processes and Land Use Successions; a conceptual review and central city example'. Economic Geography, vol. 47, no. 1, pp. 1-15.
- BOYCE, Ronald R. (1969) 'Residential Mobility and its Implications for Urban Spatial Change'. Proceedings, Association of American Geographers, I, pp. 22-26.
- BREUNING, S.M. (1970) Adelaide Transportation 1970 Report. Social Technology Systems Inc., Massachusetts.
- BROWN, Lawrence A. and HOLMES, John (1969) 'The Delimitation of Functional Regions, Nodal Regions, and Hierarchies by Functional Distance Approaches: An Unconnected Network Example and Overview'. Ohio State University.
(Mimeographed)
- BROWN, Lawrence A. and HOLMES, John (1970) 'Search Behaviour in an Intra-Urban Migration Context: A Spatial Perspective'. In Population and Migration in an Urban Context: A Spatial Perspective, Meetings of Population Association of America.
- BROWN, Lawrence A. and HOLMES, John (1971) 'Intra-urban Migrant Lifelines: A Spatial View'. Demography, vol. 8, no. 1, pp. 103-122.
- BROWN, Lawrence A. and HORTON, Frank E. (1970a) 'Functional Distance: An Operational Approach'. Geographical Analysis, vol. 2, no. 1, pp. 76-83.
- BROWN, Lawrence A. and HORTON, Frank E. (1970b) 'Social Area Change: An Empirical Analysis'. Urban Studies, vol. 7, no. 3, pp. 271-288.
- BROWN, Lawrence A. and LONGBRAKE, David (1969) 'On the Implementation of Place Utility and Related Concepts: the intra-urban migration case'. In Behavioural Problems in Geography: A Symposium, Edited by Kevin R. Cox and Reginald G. Golledge, Studies in Geography, no. 17, Dept. of Geography, Northwestern University, Evanston, Illinois.
- BROWN, Lawrence A. and LONGBRAKE, David B. (1970) 'Migration Flows in Intra-Urban space: Place Utility Considerations'. Annals, Association of American Geographers, vol. 60, no. 2, pp. 368-384.

- BROWN, Lawrence A. and MOORE, Eric G. (1970) 'Intra-urban Migration: A Perspective'. Geografiska Annaler, Series B, vol. 52, no. 1, pp. 1-13.
- BROWN, Lawrence A., ODLAND, John, and GOLLEDGE, Reginald (1970) 'Migration Functional Distance, and the Urban Hierarchy'. Economic Geography, vol. 46, no. 3, pp. 472-485.
- BRYSON, Lois and THOMPSON, Faith (1972) An Australian Newtown Life and leadership in a new housing suburb. Penguin Books.
- BURGESS, E.W. (1925) 'The Growth of the City'. in R.E. Park, E.W. Burgess and R.D. McKenzie, The City, University of Chicago Press, Chicago, pp. 47-62.
- BURNLEY, I.H. (1974) (ed.) Urbanization in Australia. The Post War Experience. Cambridge University Press, Cambridge.
- BURNLEY, I.H. (1974) 'Internal Migration and Metropolitan Growth in Australia' In Urbanization in Australia. Edited by I.H. Burnley, Cambridge University Press, pp. 99-118.
- BUTLER, Edgar W. et al. (1969) Moving Behaviour and Residential Choice: A National Survey. National Cooperative Highway Research Program, Report 81. National Research Council, Washington, D.C.
- CAPLOW, Theodore (1949) 'Incidence and Direction of Residential Mobility in a Minneapolis Sample'. Social Forces, vol. 27, pp. 413-417.
- CASETTI, Emilio (1971) 'Equilibrium Land Values and Population Densities in an Urban Setting'. Economic Geography, vol. 47, no. 1, pp. 16-20.
- CAVE, P.W. (1969) 'Occupancy Duration and the Analysis of Residential Change'. Urban Studies, vol. 6, no. 1, pp. 58-69.
- CHUGG, Derek R. (1971) 'Population Change and Intra-urban Migration in Adelaide, 1961-70'. Unpublished thesis, (B.A.Hons), Geography Dept., University of Adelaide.
- CLARK, S.D. (1966) The Suburban Society. University of Toronto Press, Toronto.

- CLARK, W.A.V. (1969) 'Information Flows and Intra-urban Migration: An Empirical Analysis'. Proceedings, Association of American Geographers, vol. 1, pp. 38-42.
- CLARK, W.A.V. (1970) 'Measurement and Explanation in Intra-urban Residential Mobility'. Tijdschrift Voor Econ. En. Soc. Geog. vol. lxi, no. 1, pp. 49-57.
- CLARK W.A.V. (1971) 'A Test of Directional Bias in Residential Mobility'. In Perspectives in Geography, I - Models of Spatial Variation. Edited by Harold McConnell and David Yaseen. Northern Illinois University Press, Illinois, pp. 2-27.
- CLARKE, John I. (1965) Population Geography. Pergamon Press, London.
- CLARKSON, James D. (1970) 'Ecology and Spatial Analysis'. Annals, Association of American Geographers, vol. 60, no. 4, pp. 700-716.
- CONGALTON, A.A. (1969) Status and Prestige in Australia. Cheshire, Melbourne.
- COOLEY, William W. and LOHNES, Paul R. (1971) Multivariate Data Analysis, John Wiley and Sons, New York.
- COULSON, Michael R.C. (1968) 'The Distribution of Population Age Structures in Kansas City'. Annals, Association of American Geographers, vol. 58, no. 1, pp. 155-176.
- CURSON, P.H. (1970) 'Polynesians and Residence in Auckland'. New Zealand Geographer, vol. 26, pp. 162-173.
- DALY, M.T. (1968a) 'Residential Location Decisions, Newcastle, N.S.W.'. Australian and New Zealand Journal of Sociology, vol. 4, no. 1, pp. 36-48.
- DALY, M.T. (1968b) 'The Lower Hunter Valley Urban Complex and the Dispersed City Hypothesis'. Australian Geographer, vol. x, no. 6, pp. 472-482.
- DAVIES, W.K.D. (1972) 'Data Analysis in Urban Geography'. Geography, vol. 57, no. 256, pp. 196-206.
- DONALDSON, B. and JOHNSTON, R.J. (1973) 'Intra-urban Sectoral Mental Maps: Further Evidence from an Extended Methodology'. Geographical Analysis, vol. 58, no. 1, pp. 45-54.
- DOUGLASS, Norman B. (1971) 'Development of Computer Maintained Electoral Rolls in South Australia'. Unpublished paper prepared for conference of electoral department officers, Melbourne.

- ERICKSON, Rodney A. (1975) 'The Spatial Pattern of Income Generation in Lead Firm, Growth Area Linkage Systems'. Economic Geography, vol. 51, no. 1, pp. 17-26.
- EVANS, K.M. (1962) Sociometry and Education (2nd impression 1966). Routledge and Kegan Paul, London, 1966.
- FERGUSON, George A. (1966) Statistical Analysis in Psychology and Education, (2nd edition), McGraw-Hill, London.
- FREDLAND, Daniel R. (1974) Residential Mobility and Home Purchase. Lexington Books, D.C. Heath Ltd., Farnborough.
- GIBSON, Jennifer G. (1967) 'The Residential Pattern and Mobility of Dutch and Greek Migrants in the Adelaide Metropolitan Area'. Unpublished thesis (B.A. Hons), Dept. of Geography, University of Adelaide.
- GOLDSTEIN, Sidney and MAYER, Kurt B. (1965) 'Demographic Correlates of Status Differences in a Metropolitan Population'. Urban Studies, vol. 2, no. 1, pp. 67-84.
- GOULD, Peter (1970) 'Is Statistix Inferens the Geographical Name for a Wild Goose?'. Economic Geography, vol. 46, no. 2, (Supplement) pp.439-458.
- GREEN, Howard Whipple (1934-42) 'Movements of Families within the Cleveland Metropolitan District.' Real Property Inventory of Metropolitan Cleveland, Reports numbers 3,5,7,9,11,13, 15 and 17.
- GREER-WOOTTEN, B. and GILMOUR, G.M. (1972) 'Distance and Directional Bias in Migration Patterns in Depreciating Metropolitan Areas'. Geographical Analysis, vol. 4, pp. 92-97.
- GRIFFITHS, Kevin R. (1973) 'The Effects of Relocation: A Reappraisal of Acquisition'. Unpublished thesis (B.A. Hons), Dept. of Geography, University of Adelaide.
- HÄGERSTRAND, T. (1957) 'Migration and Area'. Lund Studies in Geography, Series B, no. 13, pp. 27-158.
- HAGGETT, Peter (1965) Locational Analysis in Human Geography, Edward Arnold Ltd, London.
- HALL, Fred L. (1973) Location Criteria for High Schools. Research Paper Series No. 150. Dept. of Geography, University of Chicago, Chicago.
- HARRIS, C.D. and ULLMAN, E.L. (1945) 'The Nature of Cities'. Reprinted in Readings in Urban Geography. Edited H.M.Mayer and C.F.Kohn, University of Chicago Press, Chicago, 1959, pp. 277-286.

- HARTSHORN, Truman A. (1971) 'Inner City Residential Structure and Decline'. Annals, Association of American Geographers, vol. 61, no. 1, pp. 72-96.
- HAYNES, Kingsley E. and RUBE, Milton I. (1973) 'Directional Bias in Urban Population Density'. Annals, Association of American Geographers, vol. 63, no. 1, pp. 40-47.
- HAYS, William L. (1974) Statistics for the Social Sciences, (2nd edition), Holt, Rinehart and Winston, London.
- HENDERSON, Floyd M. and VOILAND, Michael P.J. (1975) 'Some Possible Effects of Energy Shortages on Residential Preferences'. The Professional Geographer, vol. xxvii, no. 3, pp.323-326.
- HERBERT, David (1972) Urban Geography A Social Perspective. David and Charles, Newton Abbot, Devon.
- HERBERT, D.T. (1973) 'Residential Mobility and Preference: a study of Swansea'. In Social Patterns in Cities, edited by B.D.Clark and M.B.Gleave, Institute of British Geographers, Special Publication No. 5, London.
- HOLMES, John H. (1971) 'External Commuting as a Prelude to Suburbanization'. Annals, Association of American Geographers, vol. 61, no. 4, pp. 774-790.
- HOOVER, E.M. (1971) An Introduction to Regional Economics, Alfred A. Knope, New York.
- HORTON, Frank E. and REYNOLDS, David R. (1970) 'Intra-urban Migration and the Perception of Residential Quality'. In Population and Migration in an Urban Context: A Spatial Perspective (Paper no.4), Meetings of the Population Association of America.
- HORTON, Frank E. and REYNOLDS, David R. (1971a) 'Effects of Urban Spatial Structure on Individual Behaviour'. Economic Geography, vol. 47, no. 1, pp. 36-48.
- HORTON, Frank E. and REYNOLDS, David R. (1971b) 'Action Space Differentials in Cities'. In Perspectives in Spatial Geography, I. Models of Spatial Variation. Edited by Harold McConnell and David A. Yaseen, Northern Illinois University Press, Illinois, pp. 83-104.
- HOYT, Homer (1939) 'The Pattern of Movement of Residential Rental Neighbourhoods'. Reprinted in Readings in Urban Geography. Edited by H.M.Mayer and C.F.Kohn, University of Chicago Press, Chicago, 1959, pp. 499-510.
- HUGO, Graeme J. (1971a) 'Internal Migration in South Australia 1961-1966.' Unpublished M.A. thesis, Dept. of Geography, Flinders University, S.A.

- HUGO, G.J. (1971b) 'Rural-Urban Migration in South Australia, 1961-1966'. 43rd Anzaas Congress, Section 21, Brisbane.
- HUGO, G.J. (1974) 'Internal Migration and Urbanization in South Australia'. In Urbanization in Australia, Edited by I.H.Burnley, Cambridge University Press, pp. 81-98.
- HUMPHREYS, J.S. (1973) 'Intra-urban Migration and Residential Structure' No. 6, Monash Publications in Geography, Dept. of Geography, Monash University, Melbourne.
- JAKLE, John A. and WHEELER, James O. (1969) 'The Changing Residential Structure of the Dutch Population in Kalamazoo, Michigan'. Annals, Association of American Geographers, vol. 59, no. 3, pp. 441-460.
- JOHNSTON, R.J. (1966a) 'The Location of High Status Residential Areas'. Geografiska Annaler, vol. 48 (Series B), no. 1, pp. 23-35.
- JOHNSTON, R.J. (1966b) 'Residential Structure and Urban Morphology'. Unpublished Ph. D. thesis, Dept. of Geography, Monash University.
- JOHNSTON, R.J. (1966c) 'The Population Characteristics of the Urban Fringe: A Review and Example'. Australian and New Zealand Journal of Sociology, vol. 2, no. 2, pp. 79-93.
- JOHNSTON, R.J. (1968) 'Choice in Classification: The Subjectivity of Objective Methods'. Annals, Association of American Geographers, vol. 58, no. 3, pp. 575-589.
- JOHNSTON R.J. (1969a) 'Some Tests of a Model of Intra-urban Population Mobility: Melbourne, Australia'. Urban Studies, vol. 6, no. 1, pp. 36-48.
- JOHNSTON, R.J. (1969b) 'Population Movements and Metropolitan Expansion: London 1960-61'. Transactions of the Institute of British Geographers, No. 46, pp. 69-91.
- JOHNSTON, R.J. (1971a) 'Some Limitations of Factorial Ecologies and Social Area Analysis'. Economic Geography, vol. 47, no. 2, (Supplement) pp. 314-323.
- JOHNSTON, R.J. (1971b) Urban Residential Patterns - An Introductory Review. G. Bell and Sons, London.
- JOHNSTON, R.J. (1972) 'Activity Spaces and Residential Preferences: Some Tests of the Hypothesis of Sectoral Mental Maps'. Economic Geography, vol. 48, no. 2, pp. 199-211.
- JOHNSTON, R.J. (1973a) Spatial Structures. Introducing the study of systems in human geography. Methuen, London.

- JOHNSTON, R.J. (1973b) 'On Frictions of Distance and Regression Coefficients'. Area, vol. 5, no. 3, pp. 187-191.
- JOHNSTON, R.J. (1973c) 'Residential Differentiation in Major New Zealand Urban Areas : A Comparative Factorial Ecology'. In Social Patterns in Cities. Edited by B.D.Clark and M.B.Gleave, Institute of British Geographers, Special Publication No. 5, London.
- JONES, F. Lancaster (1969) Dimensions of Urban Social Structure The Social Areas of Melbourne, Australia. A.N.U. Press, Canberra.
- JONES, Thomas A. (1968) 'Statistical Analysis of Orientation Data'. Journal of Sedimentary Petrology, vol. 38, no. 1, pp. 61-67.
- KIRK, Dudley (1958) 'Major Migrations Since World War II'. Reprinted in Population Geography: A Reader. Edited by G.J.Demko, H.M.Rose and G.A.Schnell. McGraw-Hill, New York, 1970, pp. 307-318.
- KIVELL, P.T. (1972) 'A Note on Metropolitan Areas, 1961-71'. Area, vol. 4, no. 3, pp. 179-184.
- KRUMBEIN, W.C. (1939) 'Preferred Orientation of Pebbles in Sedimentary Deposits'. Journal of Geology, vol. 47, pp. 673-706.
- LAZERWITZ, Bernard (1968) 'Sampling Theory and Procedures'. In Methodology in Social Research. Edited by Hubert M. Blalock, Jr and Ann B. Blalock, McGraw-Hill, New York, pp. 278-328.
- LEE, Everett S. (1966) 'A Theory of Migration'. Demography, vol. 3, pp. 47-57.
- LEE, Everett S. and BARBER, G. Putnam (1966) 'Differentials in Spatial Mobility'. In National Vocational-Technical Education Seminar on Occupational Mobility and Migration. Edited by H.G.Beard. Center Seminar and Conference Report No.2, North Carolina State University, North Carolina.
- LINGE, G.J.R. (1965) The Delimitation of Urban Boundaries. The Australian National University, Research School of Pacific Studies, Dept. of Geography Publication G/2.
- LYCAN, Richard (1969) 'Matrices of Inter-regional Migration'. Proceedings, Association of American Geographers, pp.89-95.
- MARSDEN, Brian S. (1969) 'A Critique of the Urban Delimitation Concepts in the 1966 Commonwealth Census'. Australian Geographer, vol. xi, no. 1, pp. 73-78.

- MARSHALL, Ann (1961) 'The Growth of Subdivision in The Adelaide Urban Area'. Proceedings, Royal Geographical Society of Australia, S.A. Branch, vol. 62, pp. 65-68.
- MARSHALL, Ann (1963) 'The Role of the Housing Trust in South Australian Development'. Australian Geographer, vol. 9, no. 1, pp. 57-58.
- MARTIN, Jean I. (1967) 'Extended Kinship Ties: An Adelaide Study'. Australian and New Zealand Journal of Sociology, vol. 3, no. 1, pp. 44-63.
- MARTIN, Jean I. (1970) 'Suburbia: Community and Network'. In Australian Society - A Sociological Introduction. Edited by A.F.Davies and S.Encel, Cheshire, Melbourne.
- MEYER, David R. (1971) 'Factor Analysis Versus Correlation Analysis: Are Substantive Interpretations Congruent?'. Economic Geography, vol. 47, no. 2 (Supplement), pp. 336-343.
- MISES, R.V. (1918) 'Uher die Ganzzähligkeit der Atomgewichte und verwandte Fragen'. Physikalische Zeitsch, vol. 19, pp. 490-500.
- MOORE, E.G. (1966a) 'Models of Migration and the Intra-urban Case'. Australian and New Zealand Journal of Sociology, vol. 2, no. 1, pp. 16-37.
- MOORE, E.G. (1966b) 'Residential Mobility in an Urban Context. A Systems Approach'. Unpublished Ph. D. Thesis, University of Queensland.
- MOORE, Eric G. (1969a) 'The Structure of Intra-urban Movement Rates: An Ecological Model'. Urban Studies, vol. 6, no. 1, pp. 17-33.
- MOORE, Eric G. (1969b) 'The Nature of Intra-urban Migration and Some Relevant Research Strategies'. Proceedings of the Association of American Geographers, vol. 1, pp. 113-116.
- MOORE, Eric G. (1970) 'Intra-urban Residential Mobility and Urban Spatial Structure'. In Population and Migration in an Urban Context: A Spatial Perspective (Paper No. 1) Meetings of the Population Association of America.
- MOORE, Eric G. (1971) 'Comments on the Use of Ecological Methods in the Study of Residential Mobility in the City'. Economic Géography, vol. 47, no. 1, pp. 73-85.

- MOORE, Eric G. (1972) 'Residential Mobility in the City'. Association of American Geographers, Commission on College Geography, Resource Paper No. 13.
- MORENO, J.L. (1946) 'Sociogram and Sociomatrix'. Sociometry, vol. 9, pp. 348-349.
- MORENO, J.L. (1953) Who Shall Survive? Foundations of Sociometry, Group Psychotherapy and Sociodrama. Beacon House, New York.
- MORGAN, Barrie S. (1974) 'Social Distance and Spatial Distance: A Research Note'. Area, vol. 6, no. 4, pp. 293-297.
- MORGAN, Barrie S. (1975) 'The Segregation of Socioeconomic Groups in Urban Areas: A Comparative Analysis'. Urban Studies, vol. 12, no. 1, pp. 47-60.
- MORIARTY, Barry, M. (1972) 'Locational Preferences and Urban Residential Development'. Proceedings of the Association of American Geographers, vol. 4, pp. 76-79.
- MORRILL, Richard L. (1963) 'The Distribution of Migration Distances'. Papers and Proceedings of the Regional Science Association, vol. xi, pp. 75-84.
- MORRILL, Richard L. (1965a) 'Migration and the Spread and Growth of Urban Settlement'. Lund Studies in Geography, Series B. No. 26.
- MORRILL, Richard L. (1965b) 'Expansion of the Urban Fringe: A Simulation Experiment'. The Regional Science Association Papers, vol. 15, pp. 185-199.
- MORRILL, Richard L. (1965c) 'The Negro Ghetto: Problems and Alternatives'. Geographical Review, vol. 55, pp. 339-361.
- MORRILL, Richard L. and PITTS, F.R. (1967) 'Marriage, Migration and the Mean Information Field: A Study in Uniqueness and Generality'. Annals, Association of American Geographers, vol. 57, pp. 401-422.
- MULLER, Jean-Claude (1975) 'Associations in Choropleth Map Comparison'. Annals, Association of American Geographers, vol. 65, pp. 403-413.
- MURIE, Alan (1974) Household Movement and Housing Choice. Centre for Urban and Regional Studies, Birmingham University, Occasional Paper No. 28.

- McCRACKEN, K.W.J. (1975) 'Household Awareness Spaces and Intra-urban Migration Search Behaviour'. Professional Geographer, vol. 27, pp. 166-170.
- McELRATH, D.C. and BARKEY, J.W. 'Social and Physical Space: Models of Metropolitan Differentiation'. Cited by R.J. Johnston, 'Residential Structure and Urban Morphology'. Unpublished Ph.D. thesis, Dept. of Geography, Monash University, 1966, p. 164.
- McQUITTY, L.L. (1957) 'Elementary Linkage Analysis for Isolating Orthogonal and Oblique Types and Typal Relevances'. Educational and Psychological Measurement, vol. 17, pp. 207-229.
- NIE, Norman, BENT, Dale H. and HULL, C. Hadlai (1970) Statistical Package for the Social Sciences. McGraw-Hill Book Company, New York.
- OLSON, Judy M. (1975) 'Autocorrelation and Visual Map Complexity'. Annals, Association of American Geographers, vol. 65, no. 2, pp. 189-204.
- OLSSON, Gunnar (1965a) 'Distance and Human Interaction A Migration Study'. Geografiska Annaler (Series B), vol. 47B pp. 3-43.
- OLSSON, Gunnar (1965b) Distance and Human Interaction. A Review and Bibliography. Bibliography Series no. 2. Regional Science Research Institute.
- PAPAGEORGIU, G.J. (1971) 'A Theoretical Evaluation of the Existing Population Density Gradient Functions'. Economic Geography, vol. 47, no. 1, pp. 21-26.
- PARK, R.E., BURGESS, E.W. and MCKENZIE, R.D. (1925) The City, University of Chicago Press, Chicago.
- PARKES, Don (1972) 'Elements of Time and Space for an Australian Industrial City: An Urban Social Geography'. Unpublished Ph. D. thesis, University of Newcastle.
- PETERSEN, William (1958) 'A General Typology of Migration'. American Sociological Review, vol. 23, pp. 256-266.
- POOLE, Michael A. and O'FARRELL, Patrick N. (1971) 'The Assumptions of the Linear Regression Model'. Institute of British Geographers, Transactions No. 52, pp. 145-158.
- PRYOR, Robin J. (1967) 'City Growth and the Rural-urban Fringe'. Unpublished M.A. thesis, Dept. of Geography, University of Melbourne.

- PRYOR, Robin J. (1968) 'Defining the Rural-urban Fringe'. Social Forces, vol. 47, no. 2, pp. 202-215.
- PRYOR, Robin J. (1969) 'The Residential Background of Urban Fringe Dwellers'. Australian Geographical Studies, vol. vii, no. 22, pp. 159-166.
- PRYOR, Robin J. (1971) Internal Migration and Urbanization: An Introduction and Bibliography. Monograph Series No. 2, Dept. of Geography, James Cook University, Nth. Queensland.
- RAVENSTEIN, E.G. (1885) 'The Laws of Migration'. Journal of the Royal Statistical Society, vol. 48, pp. 167-235.
- REES, Philip H. (1970) 'Concept of Social Space: Toward an Urban Social Geography'. In Geographic Perspectives on Urban Systems with integrated readings. Edited by Brian Berry and Frank Horton, Chapter 10. Prentice-Hall, New Jersey.
- REES, Philip H. (1971) 'Factorial Ecology: An Extended Definition, Survey, and Critique of the Field'. Economic Geography, vol. 47, no. 2 (Supplement), pp. 220-233.
- ROBSON, B.T. (1969) Urban Analysis. A Study of City Structure with Reference to Sunderland. Cambridge University Press, London.
- ROBSON, B.T. (1975) 'The Urban Environment'. Geography, vol. 60, no. 268, pp. 184-188.
- ROSE, Harold M. (1970) 'The Development of an Urban Subsystem: The Case of the Negro Ghetto'. Annals, Association of American Geographers, vol. 60, no. 1, pp. 1-17.
- ROSEMAN, Curtis C. (1971) 'Migration as a Spatial and Temporal Process'. Annals, Association of American Geographers, vol. 61, pp. 589-598.
- ROSEMAN, Curtis C. (1973) 'Comment in Reply'. Annals, Association of American Geographers, vol. 63, no. 1, pp. 155-156.
- ROSS, H. Lawrence (1962) 'Reasons for Moves to and from a Central City Area'. Social Forces, vol. 40, pp. 261-263.
- ROSSI, Peter H. (1955a) 'Why Families Move'. In The Language of Social Research - A Reader in the Methodology of Social Research. Edited by Paul F. Lazarsfeld and Morris Rosenberg. Free Press, Glencoe, Illinois, pp. 457-468.
- ROSSI, Peter H. (1955b) Why Families Move: A Study in the Social Psychology of Urban Residential Mobility. The Free Press, New York, 1955.

- SABINO, Antonio J. (1973) 'Residential Mobility'. Unpublished thesis, for Dip. Tech. Town Planning (S.A.I.T.), Adelaide.
- SALINS, Peter D. (1971) 'Household Patterns in American Metropolitan Areas'. Economic Geography, vol. 47, no. 2 (Supplement) pp. 234-248.
- SANDERS, Ralph A. (1975) 'The 1970 Public Use Sample: A Geographical Context'. The Professional Geographer, vol. xxvii, no. 3, pp. 347-349.
- SCHNORE, Leo F. (1956) 'The City as a Social Organism'. Urban Affairs Quarterly, vol. 1, no. 3, pp. 58-69.
- SCHWIND, Paul J. (1975) 'A General Field Theory of Migration: United States, 1955-1960'. Economic Geography, vol. 51, no. 1, pp. 1-16.
- SHEVKY, E. and BELL, W. (1955) 'Social Area Analysis: Theory, Illustrative Application and Computational Procedures'. Stanford University Press, Stanford.
- SIEGEL, Sidney (1956) Nonparametric Statistics for the Behavioural Sciences, McGraw-Hill, New York.
- SIMMONS, J.W. (1968) 'Changing Residence in the City - A Review of Intra-Urban Mobility'. Geographical Review, vol. 58, no. 4, pp. 622-651.
- SINCLAIR, D. (1975) 'A Causal Analysis of Population Turnover Rates'. Geography Bulletin, vol. 7, no. 1, pp. 4-13.
- SMAILES, Peter J. (1969) 'A Metropolitan Trade Shadow. The case of Adelaide, South Australia'. Tijdschrift Voor Econ. En. Soc. Geog., vol. 50, no. 6, pp. 329-345.
- STIMSON, R.J. (1971) 'Social Differentiation in Residential Areas in Adelaide'. 43rd Anzaas Congress, Section 21, Brisbane.
- STIMSON, R.J. (1972) 'Perceived Status and Residential Desirability of Adelaide Suburbs'. 44th Anzaas Congress, Section 21, Sydney.
- STIMSON, R.J. (1974) 'The Social Structure of Large Cities. Urbanization in Australia. Edited by I.H. Burnley, Cambridge University Press, pp. 147-164.
- STIMSON, R.J. and CLELAND, E.A. (1975) A Socio-Economic Atlas of Adelaide An analysis of the 1971 Census. School of Social Sciences, The Flinders University of S.A. and the Department for Community Welfare, South Australia.
- STOUFFER, Samuel A. (1940) 'Intervening Opportunities: A Theory Relating Mobility and Distance'. American Sociological Review, Vol. 5; pp. 845-867.

- STRETTON, Hugh (1970) Ideas for Australian Cities. By the author, Griffin Press, Adelaide.
- TIMMS, Duncan W.G. (1967) 'Occupational Stratification and Friendship Nomination: A Study in Brisbane'. Australian and New Zealand Journal of Sociology, vol. 3, no. 1, pp.32-43.
- TIMMS, D.W.G. (1971) The Urban Mosaic Towards a Theory of Residential Differentiation. Cambridge University Press.
- TRYON, R.C. (1967) 'Predicting Group Differences in Cluster Analysis: the Social Area Problem'. Multivariate Behavioural Research, vol. 2, pp. 453-475.
- WALBERG, Herbert J. and BARGEN, Mark (1974) 'Urban Spatial Models'. In Evaluating Educational Performance, A Source Book of Methods, Instruments and Examples, Chapter 19, McCutchan Publishing Corporation, Berkeley, California.
- WARD, Brian J. (1975) 'The Use of Electoral Rolls in the Study of Internal Migration'. Australian Geographical Studies, vol. 13, no. 1, pp. 94-107.
- WARNES, A.M. (1975) 'Commuting Towards City Centres: A Study of Population and Employment Density Gradients in Liverpool and Manchester'. Institute of British Geographers, Transactions No. 64, pp 77-96.
- WATERMAN, T.H. (1963) 'The Analysis of Spatial Orientation'. Ergebnisse Der Biologie, vol. 25, pp. 98-117.
- WHEELER, James O. (1967) 'Occupational Status and Work Trips: A Minimum Distance Approach'. Social Forces, vol. 45, pp. 508-515.
- WHEELER, James O. (1968) 'Residential Location by Occupational Status'. Urban Studies, vol. 5, no. 1, pp. 24-32.
- WHITELAW, J.S. (1971) 'Migration Patterns and Residential Selection in Auckland, New Zealand'. Australian Geographical Studies, vol. 9, no. 1, pp. 61-76.
- WHITELAW, J.S. (1972) 'Scale and Urban Migrant Behaviour'. Australian Geographical Studies, vol. 10, no. 1, pp. 101-106.
- WHITELAW, J.S. (1973) 'Intra-urban Migration'. Geographical Education, vol. 2, no. 1, pp. 75-87.
- WHITELAW, J.S. and GREGSON, J.S. (1972) 'Search Procedures in the Intra-urban Migration Process'. Monash Publications in Geography, No. 2.

- WHITELAW, J.S. and ROBINSON, S. (1972) 'A Test for Directional Bias in Intra-urban Migration'. New Zealand Geographer, vol. 28, no. 2, pp. 181-193.
- WILKINSON, R. and MERRY, D.M. (1965) 'A Statistical Analysis of Attitudes to Moving'. Urban Studies, vol. 2 no. 1, pp. 1-14.
- WILLIS, Jeffrey (1968) 'Population Growth and Movement'. Working Paper 12, Centre for Environmental Studies.
- WITHINGTON, William A. (1956) 'Suburban Migration: A Case Study of Winchester, Massachusetts, 1930 to 1950'. Annals, Association of American Geographers, vol. 46, no. 2, p. 281.
- WOLF, Laurence G. (1969) 'The Metropolitan Tidal Wave in Ohio, 1900-2000'. Economic Geography, vol. 45, no. 2, pp. 133-154.
- WOLPERT, Julian (1965) 'Behavioural Aspects of the Decision to Migrate'. Papers of the Regional Science Association, vol. 13, pp. 159-169.
- WOLPERT, Julian (1966) 'Migration as an Adjustment to Environmental Stress'. Journal of Social Issues, vol. 22, no. 4, pp. 92-102.
- WOLPERT, Julian (1967) 'Distance and Directional Bias in Inter-urban Migratory Streams'. Annals, Association of American Geographers, vol. 57, pp. 605-616.
- YAPA, L., POLESE, M., and WOLPERT, J. (1971) 'Interdependencies of Commuting, Migration, and Job Site Relocation'. Economic Geography, vol. 47, no. 1, pp. 59-72.
- YEATES, Maurice (1974) An Introduction to Quantitative Analysis in Human Geography, McGraw-Hill, New York.