



IMMUNOLOGICAL FUNCTION IN ATOPY AND OTHER DISORDERS

by

DAVID I. GROVE, M.B., B.S., M.R.A.C.P., D.T.M.&H.

Department of Medicine,  
University of Adelaide.

A THESIS SUBMITTED TO THE UNIVERSITY OF ADELAIDE FOR  
THE DEGREE OF DOCTOR OF MEDICINE

September, 1974.

## S T A T E M E N T

This thesis contains no material which has been accepted for the award of any other degree or diploma in any University. To the best of my knowledge it does not contain any material previously published or written by another person except when due reference is made in the text.

## ACKNOWLEDGEMENTS

The studies on which this thesis is based were carried out in the Department of Medicine, University of Adelaide, at The Queen Elizabeth Hospital during the tenure of a National Health and Medical Research Council Medical Post-graduate Research Scholarship.

I am particularly grateful to Dr. R. Munro Ford, Visiting Allergist to the Royal Adelaide Hospital, and Dr. J.G. Reid, Visiting Dermatologist to The Queen Elizabeth Hospital, for allowing me to study their private patients and to those physicians who allowed me to study patients with dystrophia myotonica who were under their care.

Some of these studies were carried out at the Papua New Guinea Institute of Medical Research (formerly Institute of Human Biology), Goroka, Eastern Highlands District. I wish to thank Dr. R.W. Hornabrook, the Director, for his courtesy in extending to me the facilities of the Institute, and to Dr. R. Taureka, Minister of Health, Papua New Guinea, for permission to carry out the study. I am indebted to Mr. A. MacGregor, Administrative Officer (Laboratory Services) for his expert assistance in establishing field contacts. I am grateful to Assoc. Professor B. McMillan, School of Public Health and Tropical Medicine, for his advice on methods of hookworm egg counting. This study was supported financially by the Clive and Vera Ramaciotti

Foundations, Sydney, with additional assistance from the Asthma Foundation of South Australia, Eli Lilly (Aust) and Company Ltd and Hoechst Australia Pty Ltd. Pyrantel Embonate (Combantrin) were supplied through the courtesy of G.P. Laboratories.

I wish to thank Mr. T.O. Burston, Assistant Biochemist, Department of Clinical Chemistry, Q.E.H., for his help in establishing the IgE assay and for measuring immunoglobulins G, A and M. Complete blood pictures were performed by the Haematology Department, Q.E.H. Miss S.J. O'Callaghan assisted me during two Christmas Vacations. I also wish to acknowledge the assistance of Mr. G. Mann in preparing the illustrations. Mr. M. O'Halloran provided invaluable statistical advice.

I especially wish to thank my supervisor, Dr. I.J. Forbes, for his unflagging enthusiasm and stimulation, for his critical review of this manuscript, and in particular for his tenacity in obtaining funds for the studies in Papua New Guinea.



Several sections of the thesis have been submitted and accepted for publication:

Grove, D.I., O'Callaghan, S.J., Burston, T.O. and Forbes, I.J. Immunological Function in Dystrophia Myotonica. Brit. Med. J. (1973) 3: 81.

Grove, D.I., Burston, T.O., Wellby, M.L., Munro Ford, R. and Forbes, I.J. Humoral and Cellular Immunity in Asthma. J. Allergy Clin. Immunol. In the press.

Grove, D.I. and Forbes, I.J. Increased Resistance to Helminth Infestation in an Atopic Population. Med. J. Aust. In the press.

Grove, D.I., Burston, T.O. and Forbes, I.J. Serum IgE and Blood Eosinophil levels in Atopic and Non-atopic Populations Infested with Hookworm. Clin. Allergy. 4: 227.

Grove, D.I., Burston, T.O. and Forbes, I.J. Fall in Serum IgE levels after Treatment for Hookworm. Clin. Exp. Immunol. In the press.

## CONTENTS

SUMMARY	1
SIGNIFICANT CONTRIBUTIONS OF THIS THESIS	6
PREFACE	7
CHAPTER I METHODS	11
CHAPTER II HUMORAL AND CELLULAR IMMUNITY IN ASTHMA	51
CHAPTER III IMMUNE FUNCTION IN ASTHMATICS TREATED WITH CORTICOSTEROIDS	96
CHAPTER IV HUMORAL AND CELLULAR IMMUNITY IN ATOPIC ECZEMA	104
CHAPTER V HELMINTHIASIS AND ATOPY	122
GENERAL DISCUSSION ON CHAPTERS II - V	146
CHAPTER VI SERUM IgE LEVELS AFTER TREATMENT FOR HOOKWORM	153
CHAPTER VII IgE AND IgD IN MISCELLANEOUS CONDITIONS	162
CHAPTER VIII IMMUNOLOGICAL FUNCTION IN DYSTROPHIA MYOTONICA	173
CHAPTER IX IMMUNOLOGICAL FUNCTION IN PAPUA NEW GUINEA HIGHLANDERS	185
REFERENCES	203

## SUMMARY

The methods used to assess various parameters of humoral and cellular immunity are described. These include the establishment of the radioactive single radial diffusion assay for Immunoglobulin E; measures of serum levels of the other major immunoglobulin classes; antibody responses to tetanus toxoid and S. typhi H antigen; delayed hypersensitivity reactions to intradermal antigen and dinitrochlorobenzene sensitization; lymphocyte tritiated thymidine uptake in whole blood culture, both spontaneous and when stimulated with phytohaemagglutinin; lymphocyte production of a cytotoxin for pigeon red cells; T and B lymphocyte numbers in the peripheral blood; and serum autoantibodies. Methods for performing faecal hookworm egg counts, blood eosinophil counts and detecting Australia Antigen are described.

Parameters of humoral and cellular immunity were measured in 91 asthmatics. Mean serum levels of IgG were raised, especially in those with a family history of atopy. Mean serum levels of IgE were raised, especially in those with a past history of eczema. There was a correlation between serum IgE levels and the absolute eosinophil count. Eighteen percent of patients failed to respond to tetanus immunization while only one patient failed to respond to S. typhi H antigen. Tetanus non-responders had a raised mean serum IgA level, reduced spontaneous lymphocyte tritiated

thymidine uptake and reduced thymidine uptake of phytohaemagglutinin-stimulated lymphocytes cultured in foetal calf serum when compared with tetanus responders. Nine percent of patients failed to mount delayed hypersensitivity reactions to a battery of five intradermal antigens. Three of four such patients could not be sensitized to dinitrochlorobenzene. The tritiated thymidine uptake of lymphocytes stimulated with phytohaemagglutinin was measured. When all subjects were considered, the mean uptake was normal for lymphocytes cultured in autologous serum, but depressed when cultured in foetal calf serum. Intrinsic asthma could not be differentiated from extrinsic asthma by any of the parameters.

Similar abnormalities were found in a study of 35 patients suffering from atopic eczema. Ten percent of patients failed to respond to tetanus immunization and 14% failed to mount delayed hypersensitivity reactions. The elevation of IgE levels was greater than that seen in asthma. IgG levels and the phytohaemagglutinin-stimulated uptake of lymphocytes cultured in foetal calf serum were normal, as were T and B lymphocyte numbers.

In a series of asthmatics receiving treatment with corticosteroids, antibody responses were marginally worse. Delayed hypersensitivity reactions were suppressed in patients receiving large doses of corticosteroids. The phytohaemagglutinin-stimulated tritiated thymidine uptake

was grossly depressed when cultured in either autologous or foetal calf serum. The mean spontaneous uptake by lymphocytes was elevated.

It is suggested that the data support the hypothesis that immune deficiency is important in the development of the atopic state in some people. It is envisaged that impaired response to antigen by the humoral or cellular immune systems results in increased stimulation of the IgE antibody system, leading to clinical disorder. The variations in the abnormalities detected between asthmatics and patients with atopic eczema may be chance variations or reflect the different clinical manifestations of the disease.

A study was carried out in the Eastern Highlands District of Papua New Guinea to test the hypothesis that a function of IgE antibodies is to assist in the control of helminth infestation. Subjects were divided into asthmatic, non-asthmatic atopic and non-atopic groups on the basis of clinical features and immediate hypersensitivity reactions to prick testing with a range of allergens. Serum IgE and blood eosinophil levels were elevated in all groups as compared with values found in temperate zones. Hookworm infestation was universal. Faecal egg counts were lower and IgE and eosinophil levels higher in the asthmatic and non-asthmatic atopic groups compared with the normal group. It is suggested that these findings are consistent

with the hypothesis that a function of the IgE immune system is to protect against helminth infestation.

A study was undertaken to investigate the effect of treatment for hookworm on IgE levels. In contrast to a previous report, IgE and blood eosinophil levels fell after treatment with anthelmintics. This accords with the general observation in other immunoglobulin classes that antibody levels fall after removal of the antigenic stimulus.

IgE levels were measured in a variety of conditions according to the availability of sera. No abnormalities were detected in patients with coeliac disease, aplastic anaemia, paraproteinaemia or with a positive serum anti-nuclear factor. There was a suggestion that levels may be elevated in alcoholic liver disease, Hodgkin's Disease and Sjogren's Syndrome.

Immunological function was also assessed in two other groups. Fifteen patients with dystrophia myotonica were studied. Although no abnormalities were detected in serum levels of the five major immunoglobulin classes, there was a rise in the serum  $\beta_1A$  complement level. Fifty four percent of patients failed to make a secondary IgG response to tetanus toxoid, while 13% failed to make a primary IgM response to S. typhi H antigen. Thirteen percent failed to make DHS reactions to intradermal antigen. The phyto-haemagglutinin-stimulated lymphocyte uptake of tritiated

thymidine was normal, but the spontaneous uptake was depressed. It is suggested that there may be a wider derangement of immunological function in dystrophia myotonica than previously thought.

A simplified battery of tests of immune function was used to investigate normal Papua New Guinea Highlanders. Normal delayed hypersensitivity reactions, but raised immunoglobulin levels, low albumin levels and impaired antibody responses to both tetanus toxoid and S. typhi H antigen were found. Albumin levels were lower and antibody responses more impaired in the group with the more adverse environmental circumstances. It is suggested that mass immunization campaigns in the tropics should be carefully assessed.

SIGNIFICANT CONTRIBUTIONS OF THIS THESIS

1. Investigation of asthmatics and patients with atopic eczema have supported the hypothesis that immune deficiency may be an important factor in the development of the atopic state in some people.
2. Investigations on the inter-relations of atopy and hookworm infestation in Papua New Guinean subjects have supported the concept that a function of the Immuno-globulin E antibody system is to assist in the resistance to helminth infestation.
3. Treatment of helminth infestation has been shown to produce a fall in serum IgE and blood eosinophil levels.
4. Evidence has been presented that the derangement of immunological function in dystrophia myotonica may be wider than previously thought.
5. Impairment of the humoral immune response in Papua New Guinea Highlanders has been shown. This has implications for the efficacy of mass immunization campaigns.



PREFACE

In 1888, Roux and Yersin demonstrated the presence of a toxin in filtrates of cultures of diphtheria organisms. This was followed with the demonstration by Knud Faber in 1890 that the tetanus bacillus also secreted such a toxin. This rapidly resulted the same year, in the discovery of an antitoxin for diphtheria toxin by Behring, and for tetanus toxin by Behring and Kitasato. These discoveries led to the concept of "antibody" and paved the way for the in vitro study of these substances.

In 1889, Charrin and Roger observed that Pseudomonas pyocynea grown in immune rabbit serum lost its motility and grew in agglomerated masses. The antibodies producing this phenomenon were named agglutinins. In 1897, Kraus demonstrated that the clear filtrate of a bacterial culture could often induce, after injection into an animal, an antibody which formed a precipitate when added to the original filtrate. These antibodies were labelled precipitins. In the earlier part of this century, much effort was devoted to the production of vaccines against communicable disease, and assessment of their effectiveness, by measurement in the serum of the antibodies so produced.

In 1883, Metchnikoff discovered the phagocytes and attributed to them a protective function by virtue of their destruction of ingested microbes. For many years the argument raged between the protagonists for Humoral defence and the supporters of the Cellular theory, until a compromise

between the two was reached.

Apart from the beneficial effects of immunity, undesirable side-effects were noted. This led to the discovery of immediate hypersensitivity reactions (see Chapter II), and delayed hypersensitivity reactions by the demonstration of the cutaneous tuberculin reaction by von Pirquet in 1907.

In the last few years, immunological responses have again been divided into humoral and cellular mechanisms, albeit in a different form. Both depend upon the activity of small lymphocytes (Gowans and McGregor, 1965) which are themselves ultimately derived from stem cell precursors which in postnatal life reside in the bone marrow (Miller and Mitchell, 1969). These precursors are considered to differentiate into two distinct lymphocyte populations. T lymphocytes are dependent upon the presence of the thymus, the absence of which inhibits the development of cell-mediated immune reactions such as delayed hypersensitivity skin reactions and homograft rejection (Miller and Osaba, 1967). B lymphocytes, independent of the thymus, synthesize humoral antibody and appear to be dependent in man upon lymphoid structures analagous in function to the Bursa of Fabricius in birds (Cooper et al., 1966). Nevertheless, cooperation between the two systems occurs in the humoral antibody response to some antigens (Miller and Osaba, 1967).

Concurrent with this improvement in understanding, has come the realization that many aspects of humoral and

cellular immunity can be measured to assess the immunological status of individuals. A variety of in vivo and in vitro tests have been developed, the requirement being that they are informative, safe and acceptable to patients (Pediatrics, 1971). They have been applied in a range of conditions such as chronic infection (Lee et al., 1971a; Forbes, 1971), peptic ulcer, ischaemic heart disease, alcoholism, diabetes (Lee et al., 1971a), autoimmune diseases (Lee et al., 1971b), malaria (Greenwood et al., 1972), trypanosomiasis (Greenwood et al., 1973), leprosy (Lancet, 1969) and kwashiorkor (Smythe, 1973).

Much of the information provided in this thesis concerns the results of the application of such tests. The methods used are described in Chapter I. The first few chapters discuss the assessment of immunological function in atopic states. Chapter II considers asthmatic patients; Chapter III, asthmatic patients receiving treatment with corticosteroids; Chapter IV, patients with atopic eczema. Chapter V reports data on the inter-relationship between atopy and hookworm infestation. Chapter VI describes the effects of treatment for hookworm on IgE and eosinophil levels. Chapter VII contains observations on IgE and IgD levels in miscellaneous conditions. The last two chapters describe two unrelated groups in whom the opportunity to investigate immunological function arose. Chapter VIII

considers patients with dystrophia myotonica and Chapter IX describes a simplified approach used in the Papua New Guinea Highlands.

## CHAPTER I

### METHODS

1. Introduction	11
2. Immunoglobulins	
(a) Immunoglobulin E	11
(b) Immunoglobulin D	25
(c) Immunoglobulins G, A and M	25
3. Antibody Responses	
(a) Tetanus antibodies	26
(b) Typhoid antibodies	27
(c) Mercaptoethanol treatment	28
4. Autoantibodies	29
5. Delayed Hypersensitivity Skin Reactions	
(a) Intradermal Antigen	29
(b) Dinitrochlorobenzene Sensitization	31
6. Phytohaemagglutinin Skin Test	31
7. Lymphocyte Tritiated Thymidine Uptake	
(a) Stimulated with Phytohaemagglutinin	32
(b) Spontaneous	36
8. Pigeon Red Cell Cytotoxicity	40

9. T and B lymphocytes	42
10. Lymphocyte Counts	44
11. Eosinophil Counts	44
12. Australia Antigen	44
13. Hookworm Egg Counts	47
14. Statistical Methods	48

## (1) INTRODUCTION

This chapter describes the techniques employed for the assessment of humoral and cellular immunity. A basic regimen had previously been established (Forbes, 1971). To this has been added assay systems for the measurement of serum Immunoglobulin E and D levels, a whole blood culture technique for the measurement of lymphocyte tritiated thymidine uptake, methods for counting T and B lymphocytes, and an assay of lymphocyte production of a cytotoxic factor for pigeon red cells. In addition, the determination of faecal hookworm egg counts is described and a summary of statistical methods is given.

## (2) IMMUNOGLOBULINS

### IMMUNOGLOBULIN E

The technique of single radial diffusion is frequently used for quantitative measurement of immunoglobulins (Mancini et al., 1965). Serum concentrations of Immunoglobulin E (IgE) are below the lower limit of sensitivity of this method, because such low concentrations of antiserum are required that antigen-antibody precipitate zones are invisible. Increased sensitivity can be obtained by using the technique of radioactive single radial diffusion described by Rowe (1969). This is achieved by applying a second antiserum, which contains a radioactive antibody to the antibody immunoglobulin in the precipitate. The radio-



activity which becomes attached to the zone of the precipitate is visualized by exposure of the plate to photographic film. An assay system using minor modifications of this technique was established.

#### Preparation of Sheep IgG

Three litres of sheep blood were obtained from the Adelaide Abbatoirs. The serum was separated by spinning at 500 g for 10 minutes. Gamma globulin was prepared initially by precipitation with saturated ammonium sulphate (Kabat and Mayer, 1961). Saturated ammonium sulphate was added dropwise and with continuous stirring, in equal volume, to 100 ml aliquots of serum at 4°C, then spun at 1,000 g for 20 minutes. The supernatant was decanted and the pellet dissolved in 0.9% saline. The protein solution was dialysed in 0.005 M phosphate buffer, pH 7.5 for 24 hours.

IgG was further purified by elution with column chromatography. Diethylaminoethyl Cellulose DE 23 Whatman Column Chromedia (W. & R. Balston Ltd., England) 60g was suspended in one litre 0.5 N HCl for 30 minutes, then filtered on a Buchner Funnel and washed with distilled water until the effluent reached a pH of 4. The cellulose was re-suspended in one litre 0.5 N NaOH for 30 minutes, then washed as before until the effluent reached a pH of 7. It was then suspended in one litre of 0.005 M phosphate buffer, pH 7.5, allowed to stand for 10 minutes, then filtered. This

procedure was repeated ten times, then a slurry of cellulose in one litre of phosphate buffer poured into a glass column 80 cm high and 3.5 cm in diameter, and allowed to settle on a pad of glass wool. Phosphate buffer was added with an intravenous drip set, and a flow rate through the column of 2 ml per minute established.

Thirty ml of dialysed protein was passed through the column together with sufficient buffer to maintain a head of 2 cm and the eluate collected in 5 ml aliquots. The optical density of each aliquot was measured by ultraviolet absorption at 2,800 Å in a spectrophotometer (Parkin-Elmer, Double Beam). Aliquots containing protein were pooled and the protein concentration estimated from the formula, 1 mg/ml protein = 1.4 absorbance units.

After passage of serum, the cellulose was washed in situ with five litres of phosphate buffer saturated with sodium chloride to elute other immunoglobulins bound to the column, and then with buffer alone until all the salt was removed.

This procedure was repeated to produce six batches. A single IgG line was obtained on immunoelectrophoresis against rabbit antiserum (Hyland Division, Travenol Laboratories, California) (Fig. 1.1).

#### Hyper-immunization of Rabbits

Purified sheep IgG was mixed with Freund's Incomplete

Adjuvant (Commonwealth Serum Laboratories, C.S.L., Parkville) to produce a concentration of 0.5 mg IgG per ml. Each rabbit was injected subcutaneously with 1 mg of sheep IgG in Freund's adjuvant in six divided doses, then fortnightly with one mg of IgG in 0.005 M phosphate buffer pH 7.5 intraperitoneally. Ouchterlony gel diffusion of sheep IgG produced a single dense line of precipitate with sera from three rabbits (Fig. 1.2).

#### Preparation of Rabbit Antisheep Globulin

Rabbits with a good antibody response were bled periodically and the serum pooled. Rabbit globulin was precipitated by adding two volumes of 24%  $\text{Na}_2\text{SO}_4$  dropwise to one volume of rabbit serum at room temperature and with continuous stirring, allowed to stand for five minutes, then spun at 30,000 g for 20 minutes. The supernatant was removed and the precipitate dissolved in cold 0.9% saline, using about one third of the original volume of serum. This was dialysed overnight against 0.05 M phosphate buffer pH 7.0 at 4°C. Ouchterlony gel diffusion of this preparation against sheep IgG confirmed the presence of rabbit antisheep IgG antibody (Fig. 1.3). The protein concentration was calculated by measurement of the absorbance in an ultraviolet spectrophotometer at 2,800 Å, then adjusted to one mg/ml with phosphate buffer. Ten ml aliquots were frozen at -20°C until required.

### Iodination of Rabbit Antisheep Globulin

Rabbit antisheep globulin was labelled with  $^{125}\text{I}$  Sodium Iodide using the method of McConahey and Dixon(1966). Twenty ml of protein solution, one mg/ml, were put in a 60 ml bottle and surrounded with ice. Four millicuries of  $^{125}\text{I}$  (Amersham) were added and continuously stirred with a magnetic stirrer. Two ml of Cloramine T, 400  $\mu\text{g}/\text{ml}$ , were added dropwise. Five minutes later, two ml of sodium metabisulphite, 400  $\mu\text{g}/\text{ml}$ , were added. Non-protein bound iodide was removed by dialysis at  $4^{\circ}\text{C}$  against 0.1 M phosphate buffer, pH 7.0 with 0.005 M potassium iodide. The dialysed protein was then made up to 40 ml with phosphate buffered saline plus 1% bovine serum albumin.

### Preparation of Antihuman IgE

Sheep antihuman IgE (Pharmacia, Uppsala, lot numbers 3593, 7320, 9958) was prepared by adding two ml distilled water to each vial. Antihuman IgE was added to phosphate buffered saline (0.1 M sodium chloride and 0.005 M potassium phosphate, pH 7.2) with 1% Bovine Serum Albumin to make 1:250, 1:500 and 1:1,000 solutions. Ten ml aliquots were stored at  $-20^{\circ}\text{C}$  until required.

### Preparation of Agarose Plates

Agarose (L'Industrie Biologique, batch F6380) 0.3 g was dissolved in ten ml 0.3 M phosphate buffer, pH 8.0 by heating to boiling, then transferred to a water bath at  $56^{\circ}\text{C}$ .

A ten ml aliquot of antihuman IgE in phosphate buffered saline with 1% Bovine Serum Albumin was warmed to 56°C for several minutes concurrently, then the two aliquots thoroughly mixed. The mixture was poured on a glass slide, 3x4x1/16 inches, pre-warmed to 37°C and placed on a flat surface. Four plates were prepared for each assay. The plates were stored overnight at 4°C, then a series of 29 holes, two or four mm in diameter, punched in the agarose.

#### Assay Procedure

Each well was filled with a constant volume of either standard or test serum so that the meniscus was level with the top of the well. Proteins were allowed to diffuse through the agarose at room temperature for 72 hours. Each plate was then placed in a closely fitting perspex container, which was in turn mounted in a rocking water bath adjusted to several oscillations per minute, and washed in phosphate buffered saline with several changes per day for 72 hours. Each plate was then layered with ten ml of iodinated rabbit antishoop globulin and allowed to stand for one hour. The iodinated globulin was removed, stored at 4°C and could be used on one more occasion. The plates were kept in a moist container overnight at room temperature, then washing was resumed for 60 hours. The plates were finally washed in distilled water for one hour, then dried and placed in contact with photographic film (Kodak RP/M2 Xomat) for 48-72 hours then developed (Fig. 1.4).

Sera were initially set up on plates with anti-IgE in a concentration of 1:500 and with wells 2 mm in diameter. Sera which produced large rings were diluted and the assay repeated. Sera with low concentrations were repeated on plates with an anti-IgE concentration of 1:2,000 and wells 4 mm in diameter.

### Standard IgE

The IgE standard used initially was from a batch of pooled human serum 69/204 supplied by the World Health Organization. Subsequently the standard serum supplied by Pharmacia (Uppsala) was used. This had been calibrated against the WHO standard.

### Calculation of Results

The diameters of the rings on the film were measured with a "Barton" Eye Gauge, capable of measuring to within 0.01 mm. A linear relationship exists between the concentration of IgE and the diameter squared of the rings. Figure 1.5 shows the result obtained when varying concentrations of IgE Standard and an unknown serum were compared with the square of the diameter of the rings.

Measurement of the same serum 23 times in eight assays gave a mean serum level of 4380 units/ml with a coefficient of variation of 16%. Over a large number of assays, 69 different sera were measured twice. Analysis of variance gave a coefficient of variation of 12% when the data were

analysed according to the method of Paradine and Rivett (1960).

#### "Phadebas" Radioimmunoassay

After establishment of the technique just described, a solid phase radioimmunoassay using Sephadex particles became commercially available ("Phadebas IgE Test Kit", Pharmacia). Sera from 103 asthmatics were compared by both methods, (Fig. 1.6). A high correlation was obtained ( $r = 0.9765$ ,  $P < 0.001$ ).

The "Phadebas" kit has the advantage of being able to measure lower serum IgE levels than the radioactive single radial diffusion method, which has a lower limit of sensitivity of about 100 units/ml. An individual run is also much quicker. On the other hand, difficulty has sometimes been experienced in calibration of the standard curve. Because of the nature of the standard curve, accuracy is considerably reduced for serum IgE levels greater than about 1,000 units/ml. Sera with levels greater than 4,000 units/ml must be diluted and repeated. Once the technique has been established, the cost per estimation is considerably less for the radioactive single radial diffusion technique.

In view of the high IgE levels generally found, estimation of levels in Papua New Guinea sera was performed only with the radioactive single radial diffusion technique.

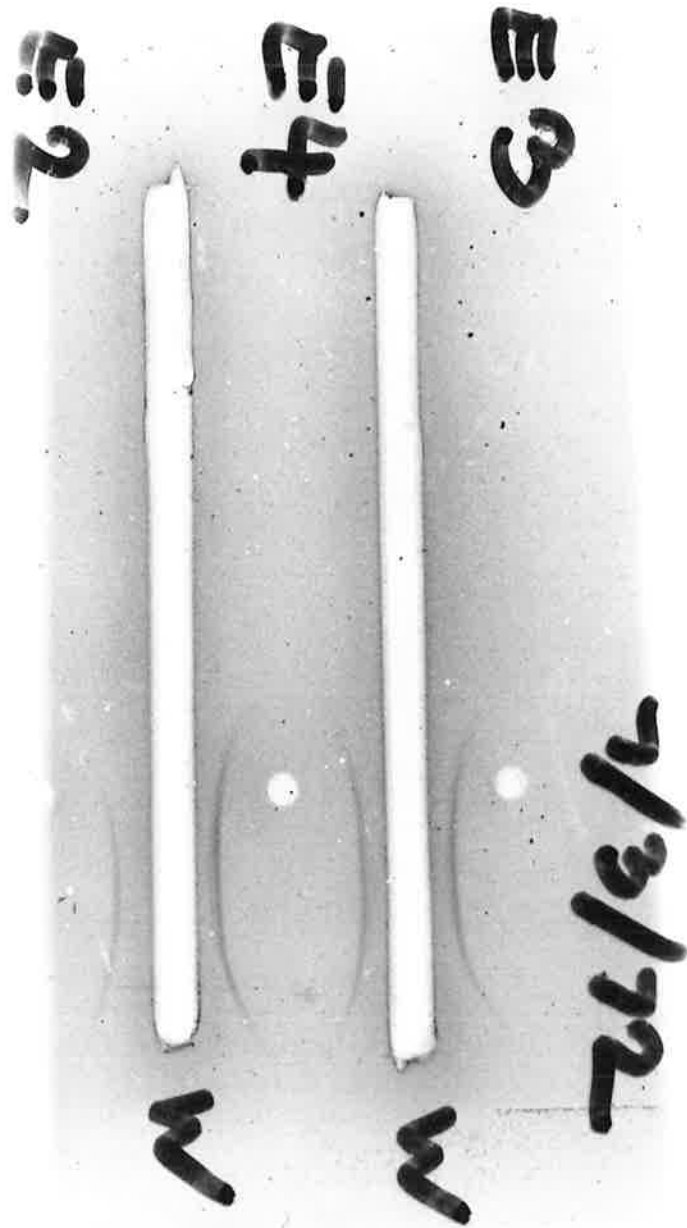

Fig. 1.1 Immunoelectrophoresis of sheep serum passed through a DEAE Cellulose column against rabbit antisheep serum, showing a single IgG line.



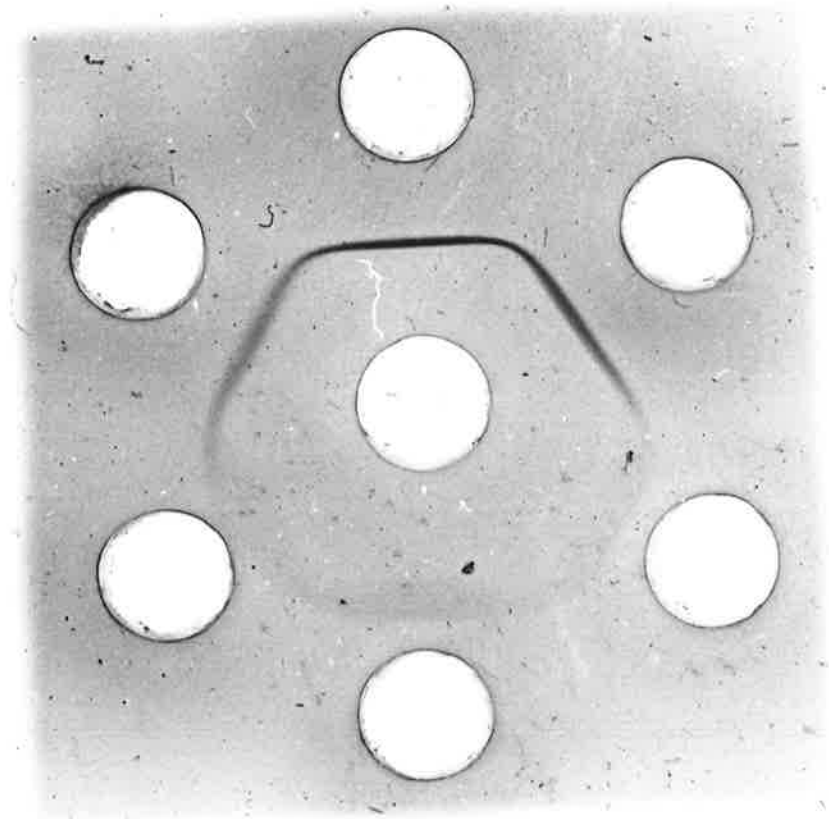

Fig. 1.2 Ouchterlony gel diffusion. Rabbit serum against sheep IgG. High antibody titres in the sera of rabbits represented by the top three wells; low titres in the sera of rabbits represented by the bottom three wells.

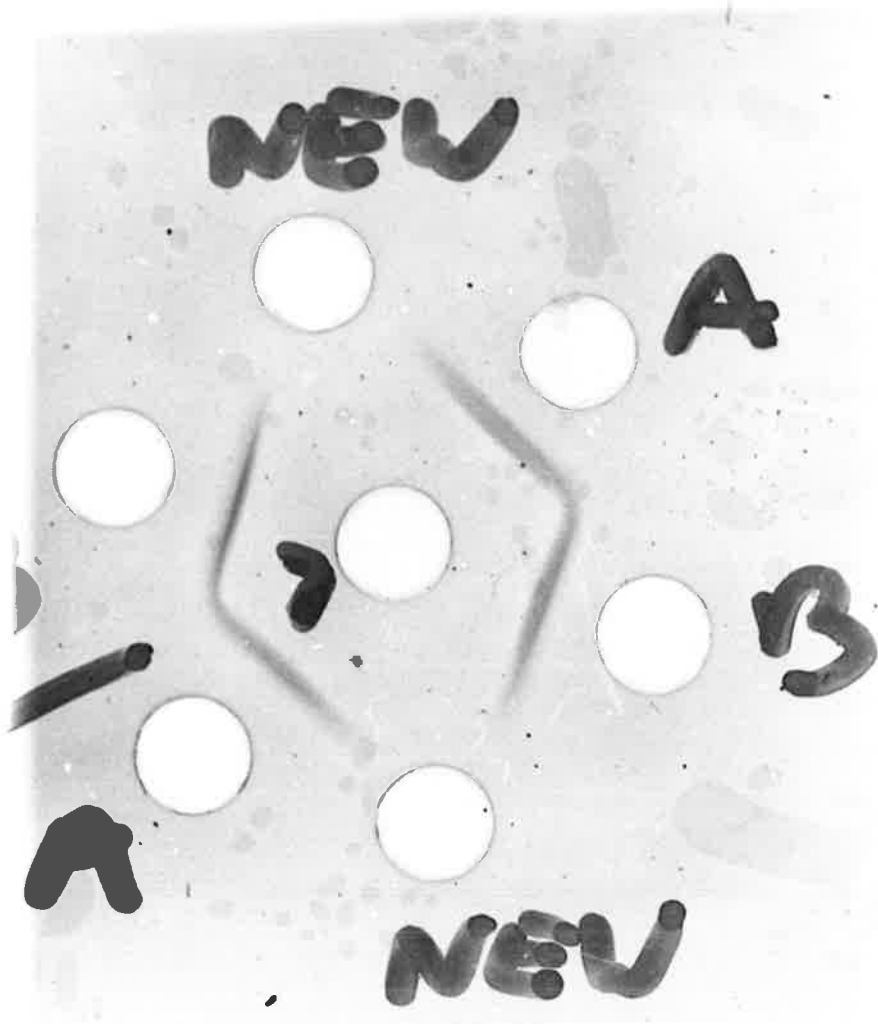

Fig. 1.3 Ouchterlony gel diffusion. Final preparation of rabbit antisheep globulin, after precipitation with  $\text{Na}_2\text{SO}_4$ , against preparations A and B.

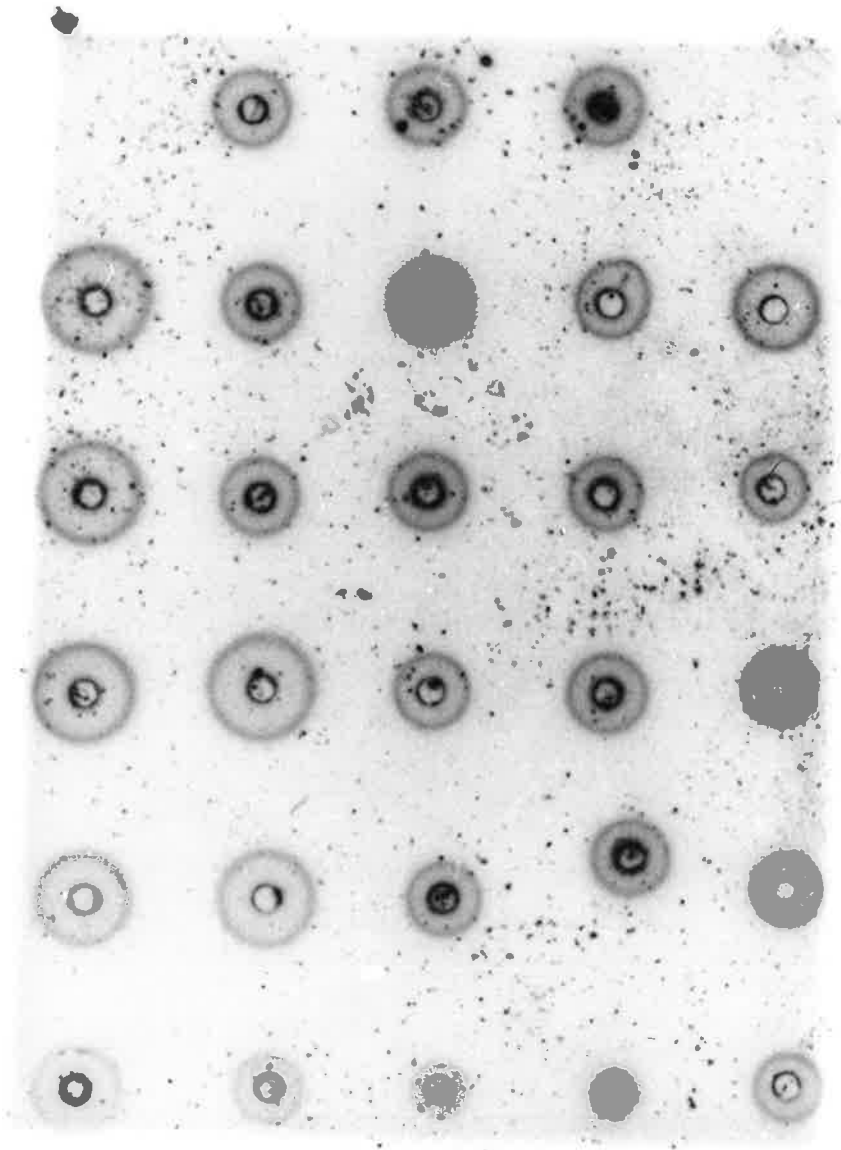

Fig. 1.4 Autoradiograph of an assay for serum IgE concentration.  $^{125}\text{I}$ -Rabbit anti-sheep IgG labelled with  $^{125}\text{I}$ .

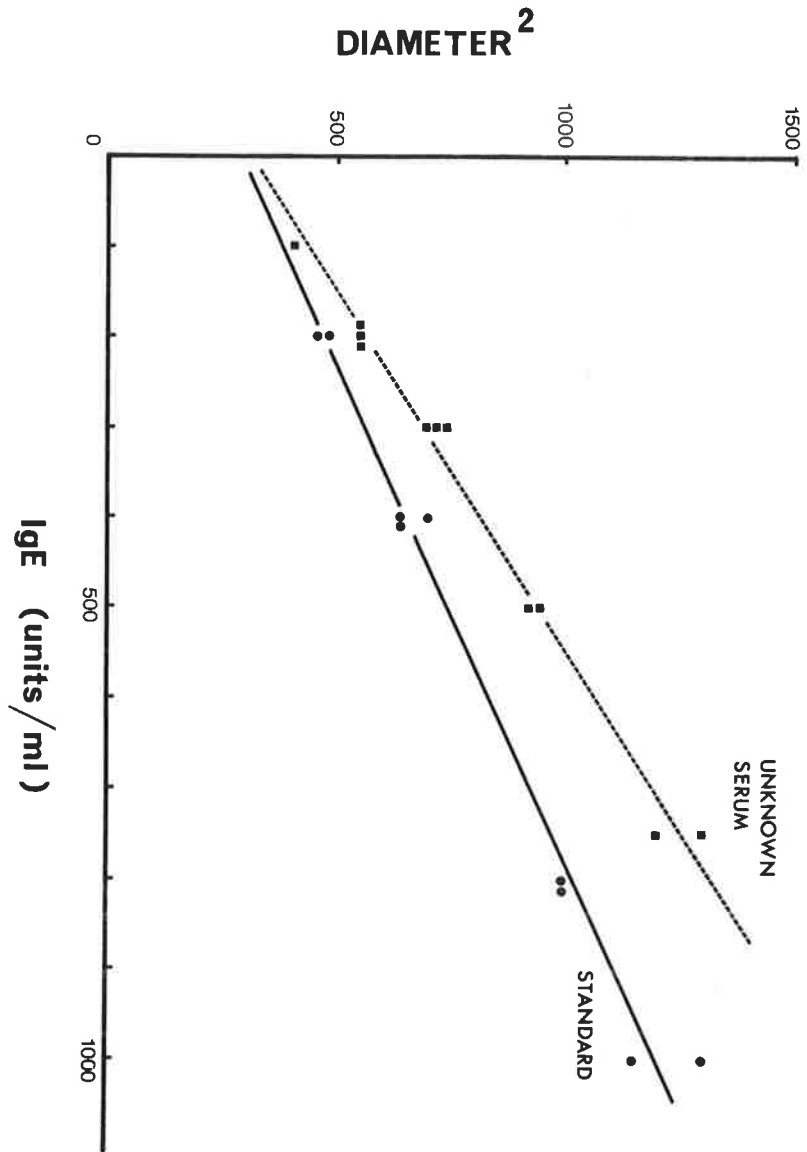

Fig. 1.5 Relation between serum IgE concentrations and the square of the diameter of the rings for WHO standard and an unknown serum.

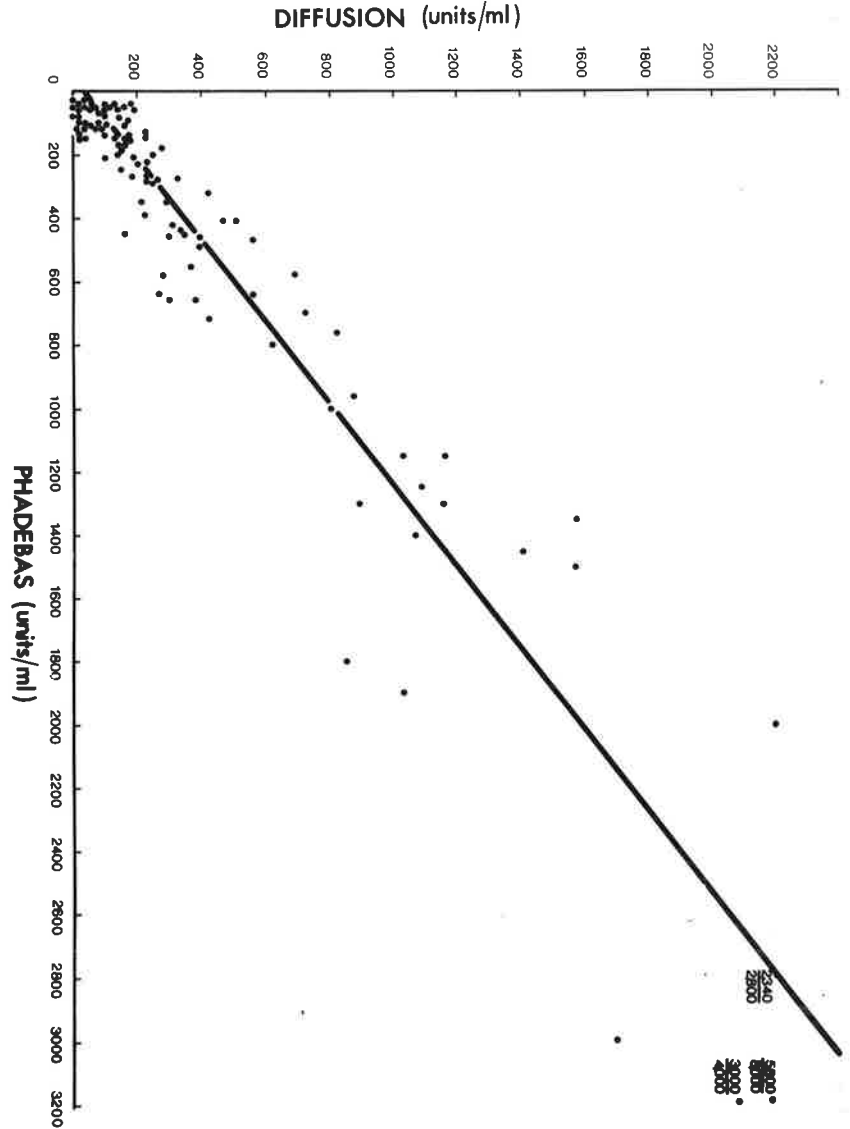

Fig. 1.6 Comparison of serum IgE levels when measured by radioactive single radial diffusion and with Phadebas IgE Test Kit.

IMMUNOGLOBULIN D

Serum IgD levels were measured by a modification of the technique used for IgE. Agarose plates were made with goat antihuman IgD (Hyland) in a final concentration of 1:300. Holes 2 mm in diameter were punched, and the assay performed as previously described. IgD Standard was supplied by Behringwerke (Marburg) and referred to British Research Standard No. 67/37. Sera with very high IgD levels were diluted in 0.9% saline and the assay repeated. Sera with low IgD levels were remeasured using 1:2,000 plates and 4 mm diameter holes.

Twenty three sera were compared using this method and Partigen Low Concentration immunodiffusion plates (Behringwerke, Marburg). A high correlation was obtained ( $r = 0.9303$ ,  $P < 0.001$ ). Approximately 40% of sera have IgD levels below the lower limit of sensitivity of the Partigen plates. The advantage of the radioactive single radial diffusion method is that it allows increased sensitivity with measurement of IgD levels possible in almost all sera.

IMMUNOGLOBULINS G, A and M

Serum IgG, IgA and IgM were measured using Behringwerke Tripartigen Immunodiffusion plates and Behringwerke Standards.

COMPLEMENT

Serum B<sub>1</sub>A complement levels were measured using Behringwerke Immunodiffusion plates and Behringwerke Standard.

ALPHA<sub>1</sub> ANTITRYPSIN

Serum alpha<sub>1</sub> antitrypsin levels were measured using Behringwerke Immunodiffusion plates and Behringwerke Standard.

(3) ANTIBODY RESPONSESTETANUS ANTIBODIES

Patients were immunized with Alum Precipitated Tetanus Toxoid (C.S.L.) 0.5 ml subcutaneously. Blood was collected at the time of immunization and two weeks later.

Tetanus antibodies were measured by the method of Gold and Fudenberg (1967). Purified tetanus toxoid was coupled to Group O Rh positive human erythrocytes.

Reagents: 5% solution of 5% Stable Plasma Protein Solution (C.S.L.) in 0.9% saline.

Tetanus Toxoid (C.S.L.) solution, 80 Lf/ml.

0.1% Chromic Chloride in 0.9% saline.

Ten ml of blood were washed three times in 0.9% saline to obtain packed red cells. Eight ml of SPPS solution were added to a control tube and 5 ml of SPPS solution and 3 ml of tetanus toxoid solution to the toxoiding tube. Three ml

of chromic chloride solution and one ml of packed red cells were added to each tube, and allowed to stand for ten minutes. The red cells were then spun down and the supernatant removed. Nine ml of 0.9% saline were added to each tube to make a 10% suspension of red cells. Adequate coupling was confirmed with serum of known high antibody titre. Serial twofold dilutions of serum were made in a dilution tray, then one drop of each dilution transferred to a white tile, one drop of red cell suspension added, mixed and allowed to stand for seven minutes. This procedure was performed with each red cell preparation. Agglutination should be observed with the toxoided red cells, but not the control red cells. Unknown sera can then be measured. The titres were expressed as the  $\log_2$  of the reciprocal of the highest dilution at which agglutination was observed.

#### TYPHOID ANTIBODIES

Patients were immunized with monovalent Salmonella typhi vaccine (C.S.L.) 0.1 ml subcutaneously. Blood was collected at the time of immunization and two weeks later.

Precipitating antibodies to S. typhi H Bacterial Suspension, flagellar antigen d, normal strength (C.S.L.) were measured. Serum was initially diluted one in ten, then serially diluted one volume in two, in 0.9% saline. 0.25 ml of each dilution was placed in a Dreyer tube, then 0.25 ml of S. typhi H suspension added. The tubes were allowed



to stand for four hours in a waterbath at 60°C, then for several hours at room temperature. The titres were expressed as the reciprocal of the highest dilution at which precipitation was observed. The zero point indicated no precipitation at a serum dilution of one in ten.

#### MERCAPTOETHANOL TREATMENT OF SERA

Sera were treated with mercaptoethanol by the method of Brown et al (1964). Undiluted serum was mixed with an equal volume of 0.2M mercaptoethanol in 0.04 M phosphate pH 7.6 and allowed to react overnight at 20°C. The treated serum was then dialysed against 0.04 M phosphate for 24 hours, then reconstituted to the original volume. A four-fold drop in titre was considered to indicate the presence of mercaptoethanol-sensitive antibody (Rowley et al., 1972).

#### DISCUSSION

The South Australian population has in general been immunized with tetanus toxoid but not with typhoid vaccine. It might be expected on these grounds that tetanus toxoid in general produces a secondary antibody response, while typhoid vaccine produces a primary response. The Victorian population has been shown to have a predominantly IgM response to primary immunization with flagellin derived from Salmonella adelaide, but almost entirely an IgG response to secondary immunization (Rowley et al., 1972). These authors

have shown that there is good correlation between mercaptoethanol treatment of sera and gel filtration or radio-immunoelectrophoresis in demonstrating immunoglobulin class of antibody. Mercaptoethanol treatment of normals (Forbes, 1971) and patients in disease states (see later) has confirmed, that in South Australians, tetanus antibodies are usually of the IgG class, while typhoid antibodies are usually of the IgM class.

#### (4) AUTOANTIBODIES

Mitochondrial antibodies, smooth muscle antibodies, gastric parietal cell antibodies and antinuclear factors were measured by the indirect fluorescent techniques of Taylor et al (1962), using rat liver and stomach, and horse antihuman immunoglobulin (Roboz Surgical Instrument Co., Washington).

#### (5) DELAYED HYPERSENSITIVITY SKIN REACTIONS

##### Intradermal Antigen

Delayed hypersensitivity (DHS) skin reactions were measured at 48 hours after intradermal injection of 0.1 ml of the following antigens prepared for skin testing:

Candida albicans 0.5% (Bencard, Brentford)

Mumps Skin Test Antigen (Eli Lilly, Indianapolis)

Streptokinase-Streptodornase ("Varidase", Lederle, New York). Diluted 1:50 in 0.9% saline, i.e.

streptokinase 10 units and streptodornase 2.5 units/ml.

In the study of asthmatic patients, two additional antigen preparations were used:

Aspergillus fumigatus "D" strength, 10,000 units/ml  
(C.S.L.) Old Tuberculin 1:1,000 (C.S.L.)

Erythema and induration of six mm or more diameter was considered a positive reaction. Reactions were measured in 99 control subjects, most being normal, but a few with vascular or psychiatric disease.

<u>Aspergillus fumigatus</u>	7%	positive
<u>Candida albicans</u>	71%	"
Mumps	76%	"
Old Tuberculin	20%	"
Streptokinase/dornase	86%	"

Only one control subject failed to react to any antigen, which accords with the expected frequency calculated using the observed frequencies for the individual antigens:

Chance of being negative to all five antigens

$$= \frac{93}{100} \times \frac{29}{100} \times \frac{24}{100} \times \frac{80}{100} \times \frac{14}{100}$$

$$= 0.72\%$$

When only Candida albicans, Mumps and Streptokinase-Streptodornase antigens were used, the observed and expected frequencies of failure of reaction to all three antigens

were 1% and 0.97% respectively.

A patient was therefore considered a positive reactor if he reacted to at least one antigen, and a negative reactor if he failed to react to all antigens.

#### Dinitrochlorobenzene Contact Sensitization

Dinitrochlorobenzene (DNCB) contact sensitization of the skin was performed by the method of Catalano et al (1972). DNCB was dissolved in acetone, 20 mg/ml. A nylon ring, 1 cm in diameter, was placed on the volar aspect of the forearm, previously cleansed with acetone. 0.1 ml of the DNCB solution was placed inside the ring, and the acetone dried with an airblower. The site was examined for an irritative reaction 48 hours later. If no new spontaneous reaction had occurred after 14 days, 0.1 ml of DNCB solution, 0.5 mg/ml, was applied as above, and examined 48 hours later for a DHS reaction. If there was still no reaction, it was considered the patient could not be sensitized..

#### (6) PHYTOHAEMAGGLUTININ SKIN TEST

The phytohaemagglutinin (PHA) skin test is probably an index of cellular immune competence (Blaese et al., 1973). A vial of PHA (Burroughs Wellcome, Beckenham) was made up to five ml with distilled water, then diluted one in twenty times in 0.9% saline. Reaction to 0.1 ml intradermally was measured at 24 and 48 hours. Erythema and induration of six mm or more diameter was considered a positive reaction.

## (7) LYMPHOCYTE TRITIATED THYMIDINE UPTAKE

Various methods have been described for in vitro study of lymphocyte transformation using cultures of purified lymphocytes or cell-rich plasma (Ling, 1968). Techniques have also been described which evaluate lymphocyte transformation in whole blood cultures either morphologically or by measure of DNA synthesis with the uptake of tritiated thymidine (Junge et al., 1970; Park and Good, 1972; Kissling and Speck, 1972). In the method described below, lymphocyte transformation in whole blood cultures, either spontaneous or stimulated with PHA was assessed by uptake of tritiated thymidine.

### PHA-STIMULATED UPTAKE

PHA, an extract of the red kidney bean, Phaseolus vulgaris, stimulates transformation of lymphocytes (Nowell, 1960). PHA selectively stimulates thymus-dependent lymphocytes (Pediatrics, 1971; Janossy and Greaves, 1972).

Mrs. K.T. Holmes, Dr. T.C. Sorrell and Dr. D.I. Newble established the optimal conditions for performance of this assay (Sorrell, 1974; Newble, 1974). Dose response curves were established with varying quantities of PHA, tritiated thymidine, blood and serum. Time response curves with varying periods of incubation were measured. The effect of variations in the pH of the culture medium were established. Results using the whole blood culture were compared with those obtained using purified lymphocyte cultures. In addition,

tritiated thymidine uptake was compared with morphological lymphocyte transformation and with nuclear volume as assessed in a multichannel analyser.

On the basis of these results, the PHA dosage producing maximum response, and the most appropriate period of incubation were used for both autologous and foetal calf serum as described below.

Reproductibility was assessed in ten patients measured at weekly intervals for three weeks. The coefficient of variation for tritiated thymidine uptake by lymphocytes in foetal calf serum was 14% and in autologous serum was 30%.

Reagents:

Preservative Free Heparin (Evans Medical, Liverpool)  
Medium 199 for tissue culture (dried) containing D.G.P.,  
Polymyxin B and Neomycin Sulphate (C.S.L.)  
HEPES (Calbiochem, San Diego).  
Phytohaemagglutinin, Reagent Grade (Burroughs Wellcome)  
made up with 5 ml sterile water per vial.  
Foetal Calf Serum, heat-inactivated (C.S.L.)  
Tritiated Thymidine, specific activity 500 mCi/mmol  
(Radiochemical Centre, Amersham)  
0.9% saline  
3% acetic acid  
10% trichloroacetic acid  
Methanol  
Soluene (Packard Instrument Co., Illinois)

Scintillation Fluid: 0.15 g dimethyl POPOP (Koch Light,  
Colnbrook)  
2.0 g PPO (Koch Light)  
1.0 L Toluene

Materials:

20 ml disposable plastic syringes and needles  
25 ml sterilized siliconized glass universal containers  
sterilized siliconized pipettes  
8 ml plastic culture tubes (Disposable Products)  
10 ml plastic centrifuge tubes (Camelec)  
25 ml scintillation vials (A.C.I.)  
Millipore Filters 0.22 microns (Bedford)

Procedure:

Medium 199 containing 2.38 g HEPES per litre was adjusted to pH 7.6 then sterilized by passage through a millipore filter. All further manipulations were conducted with an aseptic technique. Ten ml of blood was collected in a universal container with 250 I.U. of preservative-free heparin, 15 ml in another bottle for separation of serum and 5 ml of blood kept for a white cell count and differential. Triplicate cultures were set up for each patient with both autologous serum and foetal calf serum. Each tube contained 0.2 ml whole blood, 3.4 ml HEPES-buffered medium 199, 0.02 ml PHA solution and 0.4 ml of either autologous serum or foetal calf serum. Cultures were incubated for four days at 37°C. At 92 hours, 2.5  $\mu$ Ci tritiated thymidine were added

and incubated for another four hours. Cultures were then kept at 4°C for half an hour, transferred to centrifuge tubes and spun at 250 g for ten minutes. The supernatant was removed, then the precipitate washed by vortex mixing and centrifugation successively with 3% acetic acid, 0.9% saline and 5 trichloroacetic acid in 0.45% saline. After storage overnight, the tubes were centrifuged at 1,000 g for 20 minutes, then washed with 5% trichloroacetic acid and twice with methanol. The precipitate was dried by evaporation at 37°C then dissolved in 0.5 ml Soluene at 60°C for one hour. This was transferred to scintillation vials with 10 ml scintillation fluid, kept in the dark at 4°C for 24 hours then counted three times in a Packard Tricarb Liquid Scintillation Spectrometer Model 3310.

#### Expression of Results:

The uptake of tritiated thymidine was expressed as disintegrations per minute and the results for the triplicates averaged. The results were calculated in both control and asthmatic patients as both disintegrations per minute per culture tube and disintegrations per minute per million lymphocytes. In both groups, and with both autologous and foetal calf serum, a similar distribution was obtained whether the results were expressed as disintegrations per minute per culture tube, or as disintegrations per minute per million lymphocytes (Fig. 1.7). There was a highly significant correlation between both methods of expressing the



results of control cultures for both autologous serum ( $r=0.64$ ,  $n=46$ ,  $P<0.001$ ) and foetal calf serum ( $r=0.94$ ,  $n=53$ ,  $P<0.001$ ). The coefficient of variation was similar in all groups but slightly better when expressed as disintegrations per minute per culture. In view of this, and since this method indicates the absolute number of reactive lymphocytes per ml of blood, results have only been reported as disintegrations per minute per culture. In no study was there any discordance between these two methods of expressing tritiated thymidine uptake.

#### SPONTANEOUS LYMPHOCYTE TRITIATED THYMIDINE UPTAKE

The spontaneous uptake of tritiated thymidine is probably a measure of circulating immunoreactive cells (Crowther et al., 1969; Horwitz et al., 1970).

Medium 199 was prepared and blood collected as described for PHA-stimulated cultures. Triplicate cultures were set up containing 0.2 ml of whole blood in 3.8 ml of medium. Each culture was incubated with 2.5  $\mu$ Ci tritiated thymidine for four hours at 37°C then treated as described for PHA-stimulated cultures.

Autoradiography of such a culture demonstrated that tritiated thymidine was utilized by a proportion of the lymphocyte population (Fig. 1.8).

Results were expressed as disintegrations per minute per million lymphocytes and disintegrations per minute per

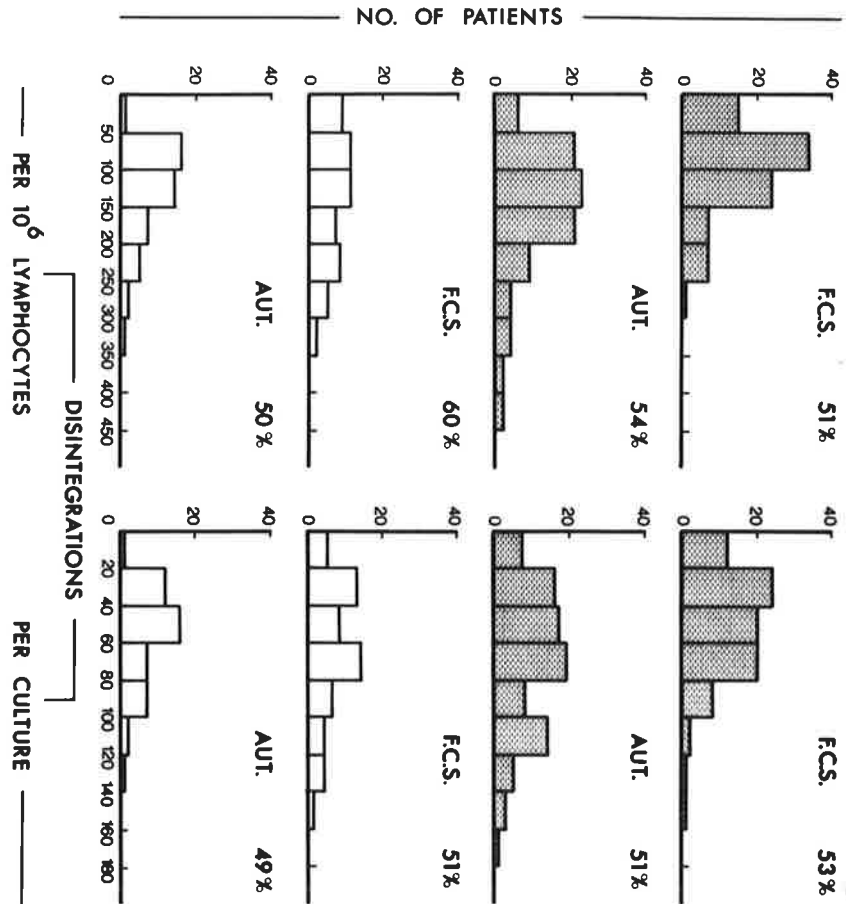

Fig. 1.7 PHA-stimulated lymphocyte <sup>3</sup>H thymidine uptake in autologous and foetal calf serum. Hatched histograms represent asthmatic patients and unhatched histograms represent normal subjects. The figures in each upper right hand corner represent coefficient of variation.

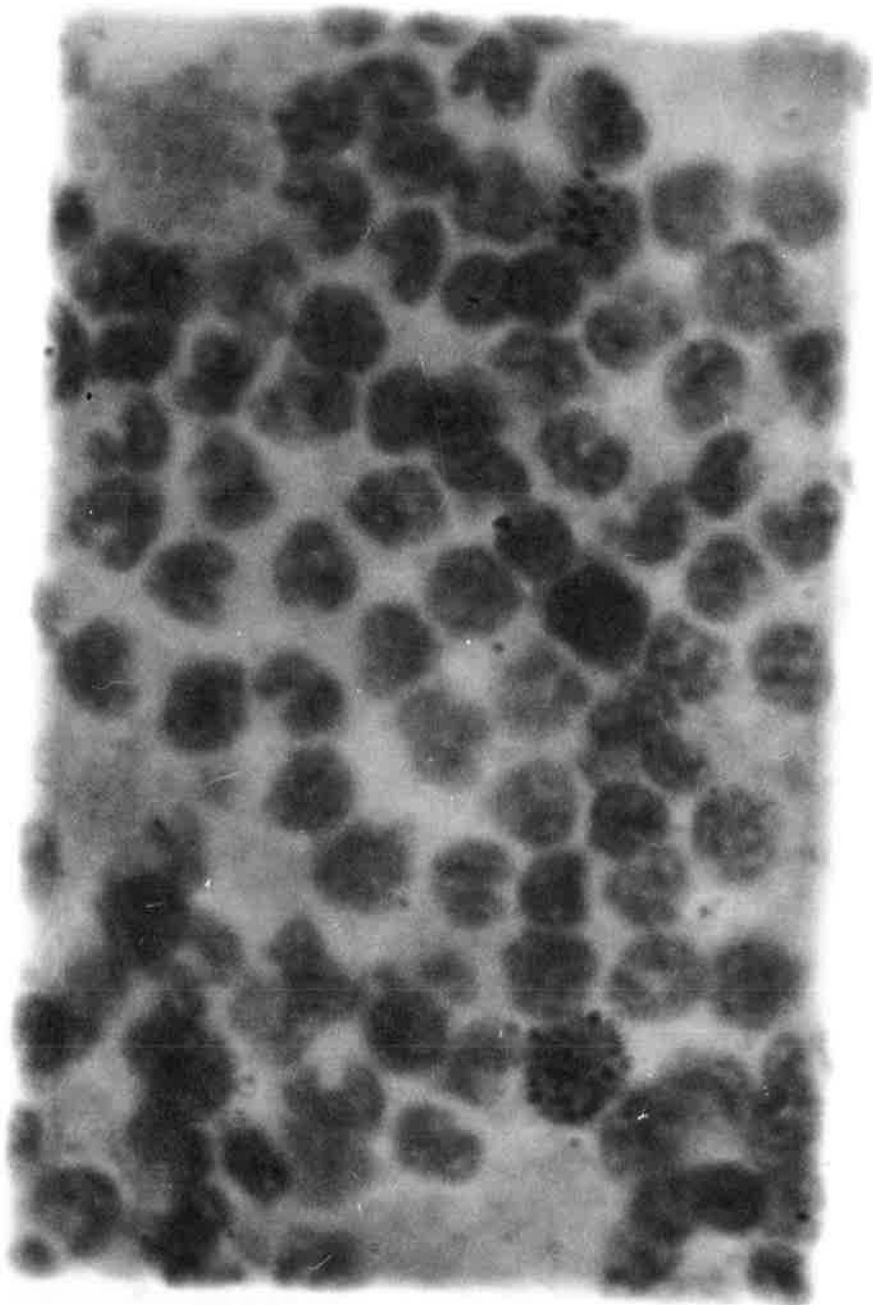

Fig. 1.8 Autoradiograph of whole blood culture incubated with tritiated thymidine, in the absence of PHA. Two cells have taken up thymidine.

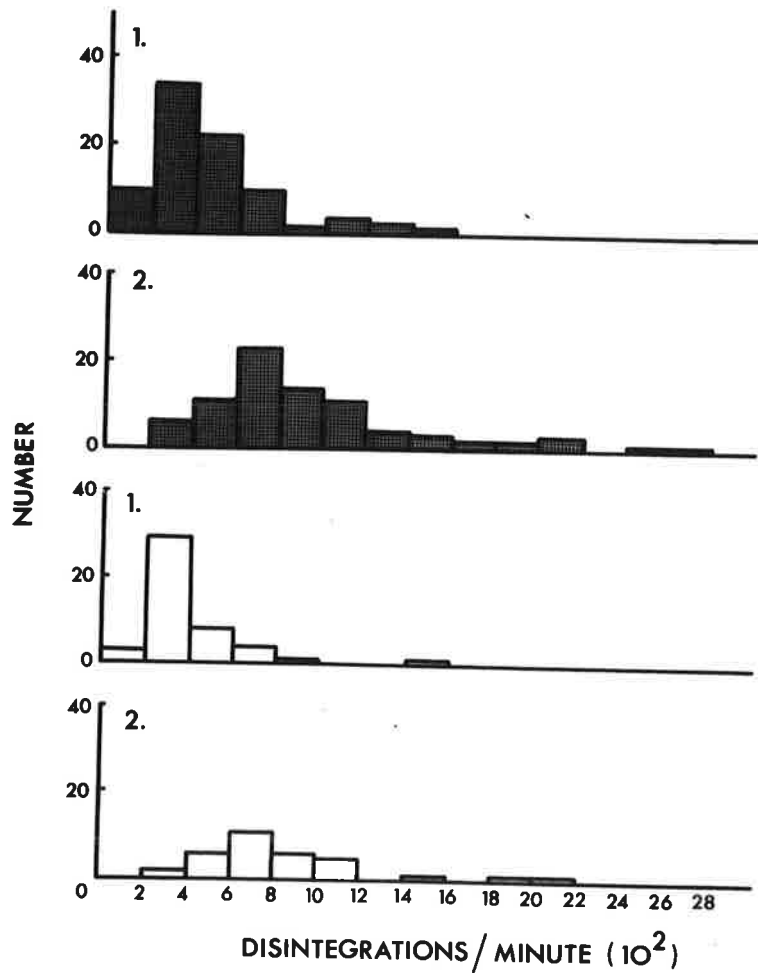

Fig. 1.9 Spontaneous lymphocyte <sup>3</sup>H thymidine uptake. Hatched histograms represent asthmatic patients and unhatched histograms represent normal subjects. Histograms labelled (1) represent disintegrations per minute per culture tube and histograms labelled (2) represent disintegrations per minute per million lymphocytes.

culture. Similar results were again found for both methods of expression in controls and asthmatics (Fig. 1.9). There was a highly significant correlation for control cultures between the two parameters ( $r=0.83$ ,  $n=33$ ,  $P<0.001$ ). Results have accordingly been reported only as disintegrations per minute per culture.

Reproducibility was assessed in ten patients measured at weekly intervals for three weeks. The coefficient of variation was 27%.

#### (8) PIGEON RED CELL CYTOTOXICITY

PHA-induced cytotoxicity by lymphocytes was measured by release of radioactivity from  $^{51}\text{Cr}$ -labelled pigeon red cells, a modification of the method described by Perlmann (1968).

Thirty ml of blood was collected in a universal container with 750 I.U. of preservative-free heparin (Evans). Twenty ml of a Hypaque/cellulose mixture (Hypaque 20 ml, methyl cellulose 880 mg, water 50 ml) was placed in a 100 ml bottle and sterilized. All further manipulations were conducted in an aseptic manner. Blood was layered on the Hypaque/cellulose mixture, then the supernatant removed after the red cells had settled, washed twice with Dulbecco Buffer (C.S.L.) and adjusted to a concentration of  $10^7$  white cells per ml.

0.05 ml pigeon blood in Alsever's solution (C.S.L.) was washed three times with Dulbecco Buffer, then made up to 10 ml with medium 199, giving a concentration of  $10^7$  red cells per ml. One ml of this suspension was incubated with 100  $\mu\text{Ci}$   $^{51}\text{Cr}$  (specific activity: 10 mCi/ $\mu\text{Mole}$ ) at  $37^\circ\text{C}$  for 45 minutes then washed three times with Dulbecco Buffer and made up to 10 ml giving a final concentration of approximately  $10^6$  red cells per ml. PHA solution was diluted 12.5 times in medium 199.

Triplicate cultures were set up containing:

1. 0.5 ml white cell suspension, 0.5 ml chromated red cells, 0.5 ml PHA solution and 0.5 ml F.C.S.
2. 0.5 ml white cell suspension, 0.5 ml chromated red cells, 0.5 ml medium 199 and 0.5 ml F.C.S.
3. 0.5 ml unchromated red cells,  $10^7$  per ml, 0.5 ml chromated red cells, 0.5 ml PHA solution and 0.5 ml F.C.S.

Cultures were incubated at  $37^\circ\text{C}$  for 24 hours, the radioactivity counted in an EKCO Scintillation Counter Type N550A, the cells spun down, supernatants removed and radioactivity counted. The release of radioactivity was calculated:

$$\frac{\text{Supernatant Radioactivity} - \text{Background Radioactivity}}{\text{Initial Radioactivity} - \text{Background Radioactivity}} \times 100\%$$

(9) T and B LYMPHOCYTES

B CELLS

Bone marrow-derived lymphocytes (B cells) carry a high density of immunoglobulin on their surface (Froland and Natvig, 1971; Wilson and Nossal, 1971). The proportions of B cells in the peripheral blood were measured by immunofluorescent staining using the method described by Froland and Natvig (1971).

Ten ml of blood was collected in a glass universal container with 250 I.U. of preservative free heparin (Evans Medical). This was diluted in two volumes of Dulbecco Buffer pH 7.4 (C.S.L.) and layered on ten ml of Ficoll/Hypaque mixture, 12 parts of 9% Ficoll (Pharmacia) in distilled water and five parts of 33% Hypaque (Winthrop, Melbourne), in a glass centrifuge tube. This was spun for 40 minutes at 400 g at room temperature. The lymphocyte layer, containing 90-95% lymphocytes, removed with a Pasteur pipette, spun down and washed twice with Dulbecco Buffer. Cells were resuspended in buffer and aliquots placed in four tubes. One drop of antiserum to IgG, IgA and IgM (Hyland) and polyvalent antiserum (Roboz) was added to separate tubes, followed by two drops of heat-inactivated foetal calf serum (C.S.L.). The tubes were incubated for one hour at 4°C, then washed three times with Dulbecco Buffer and resuspended in F.C.S. Each tube was further incubated for ten minutes at 37°C then the percentage of fluorescing

lymphocytes counted under U.V. light with a Zeiss microscope (Fig. 1.10). The absolute number of B cells was calculated from the absolute lymphocyte count.

The specificity of the antisera was confirmed by incubating cells with unlabelled antiserum for one hour at 4°C, then washing three times in buffer and re-incubating with fluorescein-labelled antiserum. Total blocking was produced with antiserum of the same class but not with antisera of other classes.

### T CELLS

A proportion of normal human peripheral blood lymphocytes have the ability to bind spontaneously in vitro with normal sheep red blood cells to form rosettes (Bach et al., 1969). These rosette-forming cells are probably thymus-derived lymphocytes (T cells) (Silveira et al., 1972; Wybran et al., 1973), although it is possible they represent only a sub-population of T cells (Dawkins and Zilko, 1973). The proportion of T cells in the peripheral blood was measured using the method of Wybran et al (1973).

A lymphocyte-rich preparation of white cells was prepared as described for B cells. Sheep red cells (C.S.L.) were washed three times in saline. A suspension of approximately  $2 \times 10^6$  lymphocytes was added to one ml of 0.5% sheep red cells and three drops of heat-inactivated F.C.S. in a centrifuge tube. The cells were then spun at 150 g for five minutes and kept at 4°C for one hour. The cells



were resuspended gently and one drop of toluidine blue added.

The percentage of rosette-forming cells was counted on a Neubauer counting chamber (Fig. 1.11). The absolute number of T cells was calculated from the absolute lymphocyte count.

(10) LYMPHOCYTE COUNTS

Total white cell counts were measured with a Coulter Counter, Model S, a differential performed, and the absolute lymphocyte count calculated.

(11) EOSINOPHIL COUNTS

In the studies performed in Australia, the absolute eosinophil count was calculated in the same way as the lymphocyte count.

In the studies performed in Papua New Guinea, the absolute eosinophil count was measured using the method of Dacie (1968): 0.1 ml of blood was diluted 1:20 in diluting fluid (eosin 0.1 g, acetone 10 ml, distilled water 90 ml), mixed, then eosinophils counted in a Neubauer Counting Chamber.

(12) AUSTRALIA ANTIGEN

Australia Antigen was measured with the commercially available radio-immunoassay kit, "Ausria" (Abbott, North Chicago).

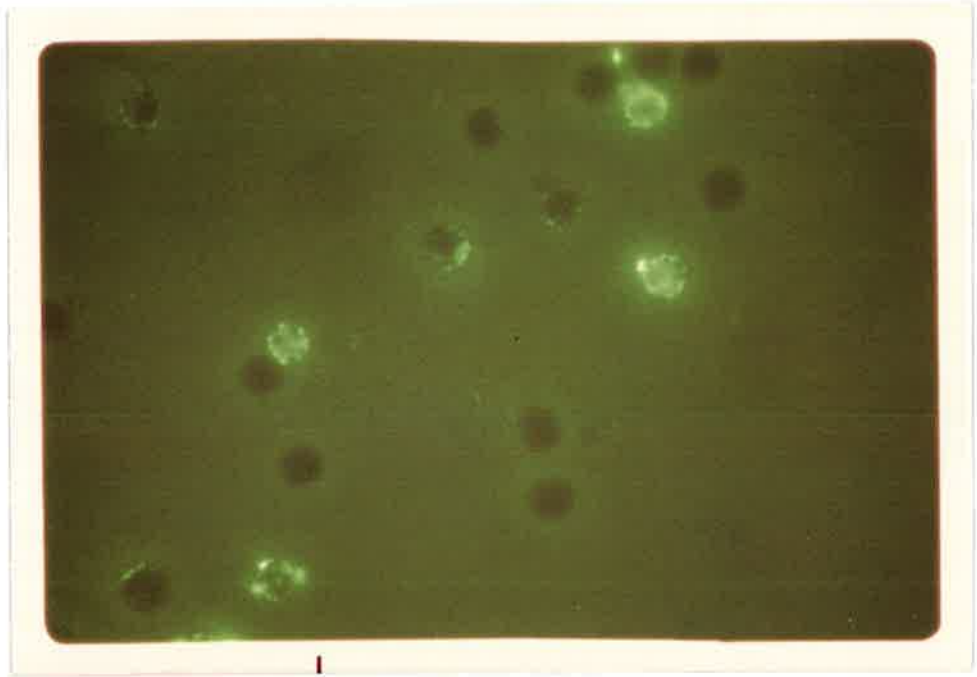

Fig. 1:10 B lymphocytes stained with fluorescein-labelled antihuman immunoglobulin under U.V. light.

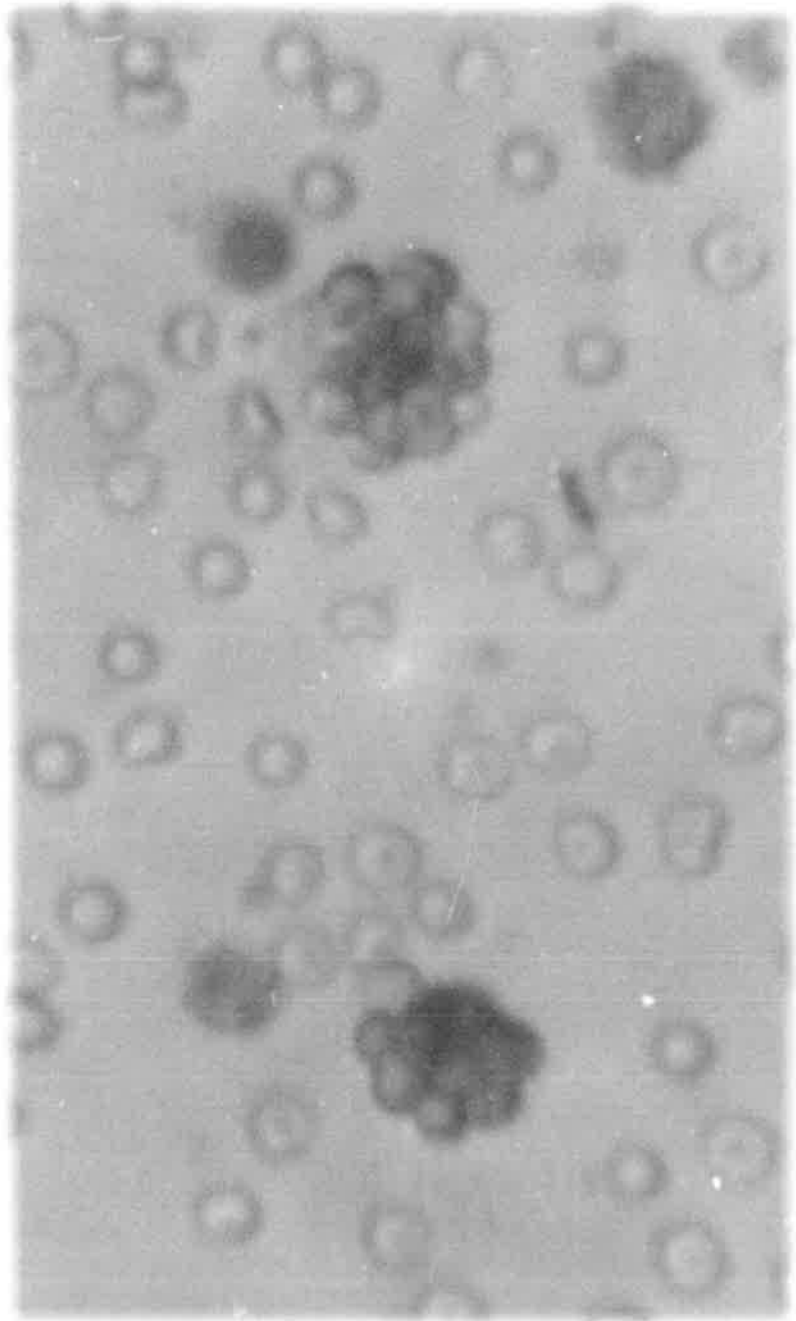

Fig. 1.11 T lymphocytes forming rosettes with sheep red blood cells.

(13) HOOKWORM EGG COUNTS

Faeces were collected in airtight plastic containers and faecal egg counts measured by the method of Gordon and Whitlock (1939). Approximately 1 g of faeces was weighed on tissue paper, mixed well with water in a test tube, saturated salt solution added to the 45 ml mark, thoroughly shaken, and transferred to a 0.3 ml Whitlock egg counting chamber, and the number of eggs counted. This procedure was performed three times and the mean egg count calculated.

Rather than introduce any possible bias, Stoll's correction factors for stool consistency were not used, (Wilcocks, Manson and Bahr, 1972). Stools were generally of the same consistency. The people were predominantly vegetable eaters, with sweet potato the principal foodstuff. It was considered that any variations in stool consistency which did occur between individuals would tend to balance out over the series, so that populations should be comparable.

Egg counts were measured six times over a period of two months in one subject, with a coefficient of variation of 24%.

Six specimens were cultured by the method of Harada and Mori (1955) and identified as Necator americanus by Mr. A. Kelly, Parasitologist, P.N.G. Institute of Medical Research.

(14) STATISTICAL METHODS

1. Normality of distribution of all populations was checked with a histogram and Davies' Test for Skewness (in Langley, 1970). Some parameters followed a log-normal distribution, in which case tests of significance were made using logarithmically transformed values. For ease of interpretation, such results have been expressed in one of two ways:

(a) In tables or charts which contain only parameters following a log-normal distribution, the results are expressed in terms of the geometric mean and the range, calculated from the mean  $\pm 1.96$  x standard deviation.

(b) In tables or charts containing some parameters following a normal, and others a log-normal distribution, the results are expressed in terms of the geometric mean and the "standard deviation" calculated as follows (Dixon and Massey, 1969).

$$\text{"S.D."} = \frac{1}{32} \left[ \begin{array}{l} \text{antilog} (\log \text{ mean} + 1.96 \log \text{ S.D.}) \\ - \text{antilog} (\log \text{ mean} - 1.96 \log \text{ S.D.}) \end{array} \right]$$

2. Significance of differences in means of two populations of small size was calculated using Student's "t" test (Paradine and Rivett, 1960):

$$t = \frac{\bar{x}_1 - \bar{x}_2 \times \sqrt{\frac{n_1 \times n_2}{n_1 + n_2}}}{\sqrt{\frac{n_1 s_1^2 + n_2 s_2^2}{n_1 + n_2 - 2}}}$$

where degrees of freedom =  $n_1 + n_2 - 2$

3. Significance of difference in means of two large populations (more than 200 samples) was calculated using the formula of Bailey (1973):

$$d = \frac{\bar{x}_1 - \bar{x}_2}{\sqrt{\frac{s_1^2}{n_1} + \frac{s_2^2}{n_2}}}$$

4. When a normal distribution was compared with a non-normal distribution, Wilcoxon's Sum of Ranks Test was used (Langley, 1970).
5. Paired "t" tests were performed as described by Bailey (1973).
6. Two by two table comparison's were made using Fisher's Exact Test (Dixon and Massey, 1969).
7.  $\chi^2$  was calculated from two row contingency tables using Brandt and Snedecor's formula (Bailey, 1973).
8. Correlation co-efficients were calculated as described by Bailey (1973).

9. Analysis of variance was performed as described by Bailey (1973) and Paradine and Rivett (1960).

## CHAPTER II

### HUMORAL AND CELLULAR IMMUNITY IN ASTHMA

Historical Background	51
Patients and Methods	58
Control Subjects	60
Results	
(a) Immunoglobulin Levels	61
(b) Antibody Responses	61
(c) Delayed Hypersensitivity Reactions	62
(d) Lymphocyte Tritiated Thymidine Uptake	62
(e) Family History of Atopy	62
(f) Past History of Eczema	63
(g) Hyposensitization Therapy	63
(h) Asthma Class	63
(i) DHS Skin Test Non-Reactors	
1. Immunoglobulin Levels	64
2. Lymphocyte Tritiated Thymidine Uptake	64
3. DNCB Sensitization	64
4. PHA Skin Tests	65
5. Pigeon Red Cell Cytotoxicity	65
(j) Tetanus Non-Responders	
1. Immunoglobulin Levels	66
2. Lymphocyte Tritiated Thymidine Uptake	66
3. Re-immunization	66



4. Family Study	66
(k) Eosinophils	67
(l) Autoantibodies	67
(m) Alpha <sub>1</sub> Antitrypsin	67
Discussion	87
Summary	95

## HISTORICAL BACKGROUND

Leonardo Botallo (1530-?), with his description of hay fever in 1564, appears to have given the first modern account of one of the atopic disorders. His patient suffered from headache, sneezing, and itching of the nose when in the presence of roses. In 1819, John Bostock (1773-1846), in an account of his own symptoms, extended these observations to the chest, by describing paroxysmal dyspnoea in association with hay fever. In 1831, John Elliotson (1791-1868) showed that pollen was a cause of hay fever. In 1873, another hay fever sufferer, Charles Blackley (1820-1900), in addition to demonstrating that attacks could be provoked by the deliberate inhalation of grass pollen, showed that it was possible to elicit localized reactions in the skin by application of pollen grains to abraded areas, and in the conjunctiva following administration of an aqueous extract.

Francois Magendie (1783-1855) had shown in 1839 that anaphylaxis (although this term was not used) was produced in rabbits after a second injection of egg albumin, having tolerated the first injection. Portier and Richet (1902) coined the term "anaphylaxis", in contrast to prophylaxis, to describe the lethal effects of a second injection of a sea anemone extract into dogs, the first having been harmless. In 1906, von Pirquet proposed the term "allergy" to describe changed reactivity to a protein, and restricted the term "immunity" to those processes in which the introd-

uction of the foreign substance into the organism caused no clinically evident reaction.

In 1911, Sir Henry Dale observed that the features of anaphylaxis, are to a large extent mimicked by histamine. In 1921, Prausnitz passively sensitized the skin of his own forearm with serum from his patient, Kustner, who was allergic to fish. When this site was challenged with fish extract, Prausnitz developed the typical weal and flare reaction, similar to that elicited directly by intradermal injection of fish extract into Kustner's forearm. This provided the first evidence for a circulating factor in the mediation of immediate hypersensitivity reactions.

In 1923, Coca and Cooke proposed the term "atopy" to denote the group of conditions with "abnormal hypersensitiveness" associated with an hereditary predisposition, such as asthma, hay fever, urticaria and atopic dermatitis. Coca and Grove (1925) used the Prausnitz-Kustner test to study the nature of the skin sensitizing substance in the sera of pollen-hypersensitive individuals. It was shown to be heat labile when tested *in vivo*, and neither fixed complement nor produced a visible precipitate when mixed with specific allergen extract in vitro. This was in contrast to antisera raised in rabbits against ragweed pollen and egg protein. In view of the uncertain nature of the substance, they referred to it as "atopic reagin" by analogy with the use of "reagin" to describe the serum

factor responsible for the Wasserman reaction.

In 1932, direct evidence was obtained that histamine was liberated during anaphylaxis in dogs (Dragstedt and Gebaur-Fuelnegg). Histamine release by antigen from human lung was shown in 1951 (Schild et al). Riley and West demonstrated in 1952 in guinea pigs, that histamine was located in mast cell granules. In 1940, Kellaway and Trethewie had shown that a slow reacting substance on smooth muscle was liberated from guinea pig lungs during anaphylaxis. This observation was confirmed by Brocklehurst in 1953, who termed this substance Slow Reacting Substance of Anaphylaxis. Beraldo, in 1950, found that a nonapeptide, bradykinin, was also released during anaphylaxis in dogs. Serotonin was found in rat mast cells in 1955 (Benditt et al), but not in those of man (Parratt and West, 1957). Chemical mediators for anaphylaxis had thus been described, but the mechanism of their release remained obscure.

With the delineation of the  $\gamma$ G,  $\gamma$ M and  $\gamma$ A immunoglobulin classes, it was initially thought that reaginic activity was to be found in the  $\gamma$ A fraction (Heremans and Vaerman, 1962). Further studies failed to support this view, nor were reagins in the newly described  $\gamma$ D fraction. Ishizaka, Ishizaka and Hornbrook (1966a,b) showed that reaginic antibodies against ragweed antigen E were to be found in a separate fraction which they labelled  $\gamma$ E. Soon afterwards, a unique myeloma immunoglobulin was found in Sweden and

called IgND (Johansson and Bennich, 1967). Subsequent studies confirmed the cross-identity of  $\gamma$ E and IgND (Bennich et al., 1969) and the name IgE was accepted for this new immunoglobulin class (Bennich et al., 1968).

The raising of antibodies in animals to human IgE enabled the hypothesis that IgE antibodies were located on mast cells and basophils to be tested. Histamine was released from leucocytes on exposure to anti-IgE (Ishizaka et al., 1969), then IgE was demonstrated on the surface of human basophils and monkey tissue mast cells by autoradiography (Ishizaka et al., 1970).

The class of antibodies principally responsible for the manifestations of asthma has now been largely defined, (although reagins may sometimes be present in the IgG fraction, Bryant et al., 1973), but the fundamental reason or reasons for clinical manifestations in a proportion of the population are still not clear. There is variability in the allergens to which an atopic individual will develop hypersensitivity, and variation in the organs which are affected. Several hypotheses, not necessarily mutually exclusive, have been advanced to explain the development of the atopic state.

#### Hereditary Predisposition

The familial clustering of atopic diseases suggests that an atopic tendency may be inherited (Cooke and Vander

Veer, 1916; Sherman, 1965). Cooke and Vander Veer concluded that hypersensitized individuals transmitted to their offspring, not their own specific hypersensitization, but rather an unusual capacity for developing reactions to any foreign proteins. Studies in rats have shown that the reaginic response to repeated minute doses of antigen can be correlated with the major histocompatibility types, thus suggesting a role for genetic control (Levine and Vaz, 1970; McDevitt et al., 1971). However, HL-A histocompatibility antigens and immediate hypersensitivity reactions in man could not be correlated in one study (Marsh et al., 1972).

Moreover, the capacity to produce skin sensitizing antibody is not limited to atopic individuals. Non-atopic as well as atopic individuals respond to parenteral immunization with protein or polysaccharide antigens with the production of reaginic antibodies (Kuhns and Pappenheimer, 1952; Leskowitz and Lowell, 1961; Greenert et al., 1971), although the last authors thought that the reaginic antibodies produced in non-atopic individuals were functionally inactive. Furthermore, anaphylactic reactions to drugs, foreign sera and insect bites may occur in otherwise non-atopic individuals, (Alexander, 1955; Schwartz and Kahn, 1970).

An allergic diathesis seems to be an important but not an absolute prerequisite for the development of immediate hypersensitivity reactions (Leskowitz et al., 1972).

### Enhanced Reactivity to Pharmacological Intermediates

Increased sensitivity to pharmacological intermediates released from mast cells or basophils as a result of the interaction of antigen with surface IgE may be an underlying fault in atopy. Provocation by inhalation or parenteral challenge with histamine or acetyl-methylcholine results in significantly greater bronchoconstriction in atopics than non-atopics (Townley et al., 1965). However, atopic and non-atopic individuals respond equally to skin testing with histamine, serotonin and 48/80 (Leskowitz and Lowell, 1961).

### Beta Adrenergic Blockade

It has been suggested that asthma is associated with a functional imbalance of the autonomic nervous system, by partial blockade of the beta adrenergic system (Reed, 1968; Szentivanyi, 1968). This theory proposes that blockade of the beta adrenergic system is the mechanism by which bronchial hyperreactivity results from a wide variety of stimuli: immunological, psychiatric, infectious, chemical and physical.

### Prolonged Retention of Antigen

Prolonged immunization results in the production of reaginic antibodies (Greenert et al., 1971). It is possible that an enzyme or other defect allows prolonged retention of antigen with consequent heightened reaginic antibody production (Leskowitz et al., 1972).

### Mucosal Barrier Defect

Intranasal instillation of protein and polysaccharide antigens more readily induces reaginic activity in atopic than normal individuals (Salvaggio et al., 1964, 1966, 1969). In contrast, when antigen was given parenterally, there was no difference in the numbers of atopic and non-atopic individuals who developed reaginic antibodies. These findings suggested that in atopics there is a defect in the mucosal barrier which leads to more efficient contact between antigen and immunologically competent cells. This defect might lie in the mucous membranes themselves, their secretions, or the quality and quantity of local antibody-producing cells (Leskowitz et al., 1972).

### Immune Deficiency

In 1937, Rostenberg and Sulzberger showed that patients with atopic dermatitis were much less likely to react to patch testing with a wide range of antigens than patients with contact dermatitis. However, patients with atopic eczema were not compared with normal controls. Nevertheless, Kaufman and Hobbs (1970) have suggested that this may be the first record of an association between atopy and immune deficiency. Kuhns and Pappenheimer (1952) described the case of a boy who, on being re-immunized with diphtheria toxoid, had an anaphylactic reaction. Subsequent investigation showed that some atopic and some non-atopic individuals produced reaginic, but not precipitating, antibodies to



diphtheria toxoid. A high prevalence of atopy has been noted in immunoglobulin deficiency syndromes (Hobbs, 1969). Conversely, immunoglobulin deficiencies, especially of IgA, were found in more than 7% of atopic subjects (Kaufman and Hobbs, 1970). They suggested that "atopy develops in individuals whose immunological vocabulary is backward".

This study was undertaken in an attempt to determine, by measurement of various parameters of humoral and cellular immunity, whether it was possible to find more evidence of immune deficiency in asthma.

#### PATIENTS AND METHODS

Forty two male and forty nine female asthmatics were studies. Ages ranged from 9 to 63 years, with a mean age of 31 years. There was one patient in the first decade, and 18, 22, 29, 13, 6 and 2 patients in each succeeding decade. These were unselected patients who presented at the rooms of an allergist and agreed to take part in the study.

Patients were considered to be asthmatic if they gave a history of intermittent wheezing and shortness of breath which either resolved spontaneously or on treatment with bronchodilators (Scadding, 1963). Many patients had additional objective evidence of reversible airways obstruction on spirometry before and after inhalation of orci-prenaline. It was difficult to demarcate clearly all

patients as either intrinsic or extrinsic asthmatics, therefore each patient was classified into one of the following five groups on the basis of the clinical features and results of skin testing for immediate hypersensitivity and without knowledge of the other immunological findings.

- (1) Extrinsic: only caused by demonstrable allergens. Symptoms usually worse in spring and summer. All had positive skin tests.
- (2) Mostly Extrinsic: as in 1 plus some wheezing after colds or for no apparent reason.
- (3) Extrinsic-Intrinsic: evenly balanced 1 and 5.
- (4) Mostly Extrinsic: as in 5 plus some incrimination of extrinsic factors.
- (5) Intrinsic: no demonstrable extrinsic cause, but wheezing frequently associated with respiratory infections, weather changes, emotion, exercise, often with a tendency for symptoms to be worse in winter. All had negative skin tests.

Most patients were receiving some form of drug therapy, both prior to, and during the study. Fifty one patients were receiving bronchodilators, either orally or by inhalation. Twenty seven were taking antihistamines; 18, disodium cromoglycate 20-80 mg daily; 12, antibiotics, mostly benzathine penicillin; 3, bromhexine; one,

amitriptyline, and one, diazepam. Thirty one patients had been on a course of hyposensitizing injections, twice a week or more, for at least one month, with graded antigen preparations (Commonwealth Serum Laboratories, C.S.L.).

Skin testing for immediate hypersensitivity reactions to a wide range of allergens, assessment of respiratory function by spirometry, and classification of the patients as described above, were performed by Dr. R. Munro Ford. Patients were interviewed and a clinical history taken. Serum immunoglobulin levels, lymphocyte  $^3\text{H}$  thymidine uptake, DHS skin reactions to aspergillus, candida, mumps, old tuberculin and streptokinase-streptodornase antigens and antibody responses to immunization with tetanus toxoid and typhoid vaccine were measured as previously described.

#### CONTROL SUBJECTS

The control values were established on normal people, together with a few patients suffering from vascular or neurological diseases. Control patients were not receiving drug therapy. Not all parameters were measured for each control subject. The mean age, and standard deviation around the mean of the controls is listed:

IgG	34 ± 16 years
IgA	"
IgM	"
IgD	29 ± 11

IgE	37 ± 18 years
Tetanus antibody response	35 ± 17
Typhoid antibody response	"
Skin test reaction	39 ± 18
PHA uptake - autologous serum	28 ± 10
PHA uptake - foetal calf serum	29 ± 10
Spontaneous uptake	31 ± 11

These age distributions are comparable with that of the asthmatic population studied (31 ± 12 years).

## RESULTS

### Immunoglobulin Levels

Mean serum levels of IgG and IgE were raised in asthmatics (Table 2.1). Levels of IgA, IgM and IgD were normal.

### Antibody Responses

Antibody titres were measured before and after immunization in 74 asthmatics. Haemagglutinating antibodies to tetanus toxoid were not detectable in 13 (18%) of the patients (Fig. 2.1). This result is highly significant ( $P < 0.001$ , Fisher's Exact Test) when compared with only one failure to make antibody in 74 age and sex-matched controls.

Response to tetanus immunization was not related to past history of eczema, or family history of atopy. Statistical analysis did not relate failure of tetanus response

to drug therapy.

Precipitating antibodies to S. typhi H antigen were not detectable in one of the 74 asthmatics. No failure to respond occurred in controls. This result was not statistically significant.

#### Delayed Hypersensitivity Reactions

DHS reactions were measured in 87 patients. Eight (9%) failed to react to any of the five antigens ( $P < 0.02$ ) compared with only one such failure in 87 controls (Table 2.2).

#### Lymphocyte Tritiated Thymidine Uptake

The uptake of  $^3\text{H}$  thymidine by lymphocytes is shown in Table 2.3. The uptake of  $^3\text{H}$  thymidine by lymphocytes stimulated by PHA in the presence of autologous serum was normal, while there was a depressed uptake in the presence of foetal calf serum (Fig. 2.2). The spontaneous uptake of  $^3\text{H}$  thymidine by lymphocytes fell within the normal range.

Analysis of the data revealed no difference in patients receiving antihistamines, disodium cromoglycate, antibiotics, or bronchodilators (Table 2.4).

#### Family History of Atopy

The influence of a family history of asthma, hay fever or atopic eczema is shown in Table 2.5. Patients with a positive family history had significantly higher IgG levels than those without such a history. Patients with a negative

family history did not have significantly elevated IgG levels when compared with controls.

#### Past History of Eczema

The influence of a past history of eczema is shown in Table 2.6. Only three patients were currently suffering from atopic dermatitis. Serum IgE levels were significantly elevated in the group with a positive past history of eczema compared with those without such a history.

#### Hyposensitization Therapy

The effect of hyposensitization therapy is shown in Table 2.7. Patients who had been undergoing such therapy for at least one month had significantly reduced spontaneous lymphocyte  $^3\text{H}$  thymidine uptake.

#### Asthma Class

Parameters were considered in relation to asthma classification. There were no significant differences in immunoglobulin levels between asthma classes for all five major immunoglobulin classes (Table 2.8), including IgE (Fig. 2.3).

PHA-stimulated  $^3\text{H}$  thymidine lymphocyte uptake in autologous serum and the spontaneous  $^3\text{H}$  thymidine lymphocyte uptake was similar in each asthma class. PHA-stimulated  $^3\text{H}$  thymidine lymphocyte uptake in F.C.S. was uniformly depressed throughout the asthma classes (Table 2.9). Impaired DHS reactions and tetanus antibody responses were not related to

asthma class.

### DHS Skin Test Non-Reactors

#### (1) Immunoglobulin Levels

Immunoglobulin levels in DHS skin test reactors are compared with those who failed to make such reactions in Table 2.10. There were no significant differences for any of the immunoglobulin classes, although the mean IgE level was higher for the non-reactors.

The mean serum IgE levels in reactors and non-reactors to individual skin tests are shown in Table 2.11. There was a significantly higher serum IgE level in those patients who failed to mount a reaction to candida antigen. A similar, though in the individual cases, not significant, trend was seen with the other four antigens.

#### (2) Lymphocyte Tritiated Thymidine Uptake

Although  $^3\text{H}$  thymidine uptake of PHA-stimulated lymphocytes in both autologous and foetal calf serum was depressed in non-reactors, this was not at a statistically significant level (Table 2.10). There was no significant difference in spontaneous lymphocyte  $^3\text{H}$  thymidine uptake.

#### (3) DNCB Sensitization

Four asthmatics who failed to react to at least one antigen were exposed to DNCB. Three failed to react either spontaneously at two weeks or on challenge. This

compares with a spontaneous reaction at two weeks by five subjects who had reacted positively after intradermal injection to at least one of the candida, mumps and streptococcal antigens. Two of these subjects were asthmatics and three were normal control subjects.

#### (4) PHA Skin Tests

Five asthmatics who failed to react to at least one antigen were skin tested with PHA. All subjects had a positive reaction.

#### (5) Pigeon Red Cell Cytotoxicity

Ability of lymphocytes to produce a cytotoxic factor for  $^{51}\text{Cr}$ -labelled pigeon red cell when stimulated with PHA is shown in Table 2.12.

Four asthmatics who failed to react to DHS testing, and one asthmatic who reacted normally, were studied. There were no differences in chromium release when compared with eight normal controls. Both asthmatics and controls had positive PHA skin tests. In contrast, one lymphoma patient who was skin test negative to antigen, weakly positive to PHA and who had grossly depressed PHA-stimulated lymphocyte tritiated thymidine uptake, had impaired production of cytotoxic factor.

#### Tetanus Non-Responders

Patients who failed to respond to tetanus immunization



had a variety of other immunological abnormalities when compared with patients who did respond (Table 2.13).

(1) Immunoglobulin Levels

Tetanus non-responders had significantly elevated levels of IgA. There were no significant differences for the other immunoglobulin classes.

(2) Lymphocyte Tritiated Thymidine Uptake

The  $^3\text{H}$  thymidine uptake by lymphocytes cultured in F.C.S. and stimulated with PHA was depressed in all asthmatics compared with normals, but much more so in those patients who failed to respond to tetanus immunization.

The spontaneous lymphocyte  $^3\text{H}$  thymidine uptake was also depressed in tetanus non-responders.

(3) Re-immunization

Twelve patients who failed to respond to tetanus immunization were re-immunized several months later. All subjects responded to repeat immunization.

(4) Family Study

Forty one relatives of nine tetanus non-responsive probands were immunized and tetanus antibodies measured two weeks later. Relatives included parents, children, sibs and nephews and nieces. Failure of tetanus response was found in four of the relatives. In one family, three sisters; in a second family, two sisters; and in a third

family, a mother and son, failed to respond to tetanus immunization.

### Eosinophils

Blood eosinophil levels were significantly elevated in asthmatics compared with controls (Table 2.14). There were no significant differences in eosinophil levels between the asthma classes.

The relationship between serum IgE level and the eosinophil count is shown in Figure 2.4. Although there was a significant correlation between the two parameters in the group as a whole ( $r=0.5215$ ,  $P<0.001$ ), there were large discrepancies in some individual cases.

### Autoantibodies

Autoantibodies were measured in 91 patients. Smooth muscle antibodies were detected in four, three of whom had an asthma classification of class 4 and one of class 5. Two patients had gastric parietal cell antibodies. Anti-nuclear factor was not detected. These values do not differ significantly from the normal range established for the Queen Elizabeth Hospital.

### Serum Alpha<sub>1</sub> antitrypsin

Serum electrophoresis was performed on all specimens. Alpha<sub>1</sub> globulin levels were low in some sera, so alpha<sub>1</sub> anti-

trypsin levels were measured in the twenty sera with the lowest values. The mean value of  $199 \pm 33$  units / ml did not differ significantly from twenty age and sex matched controls ( $213 \pm 79$  units / ml).

Table 2.1

SERUM IMMUNOGLOBULIN LEVELS

	No.	Mean	S.D.	Probability
IgG Asthmatics	91	1460	304	<0.001
Controls	88	1190	311	
IgA Asthmatics	91	203	90	N.S.
Controls	87	197	77	
IgM Asthmatics	91	149*	56	N.S.
Controls	89	148*	70	
IgD Asthmatics	91	12*	47	N.S.
Controls	74	16*	62	
IgE Asthmatics	91	225*	480	<0.001
Controls	100	100*	110	

\* Geometric Mean

Probability by Student's "t" test

N.S. Not Significant

IgG, IgA, IgM: mg/100 ml

IgD, IgE: units/ml

Table 2.2

DELAYED HYPERSENSITIVITY REACTIONS

	Reactors	Non-Reactors	Probability
Asthmatics	79	8	<0.02
Controls	86	1	

Probability by Fisher's Exact Test

Table 2.3

LYMPHOCYTE <sup>3</sup>H THYMIDINE UPTAKE<sup>†</sup>

		No.	Mean	S.D.	Probability
PHA <sup>3</sup> H Uptake - autol. serum	Asthmatics	90	73,000	37,700	N.S.
	Controls	74	76,000	39,400	
PHA <sup>3</sup> H Uptake - F.C.S.	Asthmatics	90	52,500	27,600	<0.001
	Controls	84	71,500	32,300	
Spontaneous <sup>3</sup> H Uptake	Asthmatics	80	392*	299	N.S.
	Controls	90	400*	208	

† Disintegrations/culture/minute

\* Geometric mean

Probability by Student's "t" test

N.S. Not Significant

Table 2.4

DRUGS and LYMPHOCYTE UPTAKE \*

Drug	Consumption	Number	Mean	S.D.
<u>Autologous Serum</u>				
D.S.C. †	+	18	72,000	30,000
	-	72	73,000	39,000
Antibiotics	+	12	81,000	36,000
	-	68	72,000	37,000
Antihistamines	+	27	73,000	39,000
	-	63	73,000	34,000
Bronchodilators	+	51	73,000	37,000
	-	49	73,000	36,000
<u>F.C.S.</u>				
D.S.C. †	+	18	58,000	25,000
	-	72	52,000	28,000
Antibiotics	+	12	53,000	24,000
	-	68	52,000	28,000
Antihistamines	+	27	55,000	25,000
	-	63	51,000	29,000
Bronchodilators	+	51	53,000	27,000
	-	49	53,000	26,000

\* Disintegrations/culture/minute

† D.S.C. = Disodium cromoglycate

Table 2.5

FAMILY HISTORY OF ATOPY

	History	No.	Mean	S.D.	Probability
IgG	+	68	1,500	315	<0.05
	-	22	1,350	230	
IgA	+	68	203	94	N.S.
	-	22	197	80	
IgM *	+	68	153	59	N.S.
	-	22	135	43	
IgD *	+	68	13	54	N.S.
	-	22	10	30	
IgE *	+	68	207	455	N.S.
	-	22	280	395	
PHA Autol. <sup>3</sup> H	+	68	71,000	35,400	N.S.
	-	20	78,800	42,000	
PHA FCS <sup>3</sup> H	+	68	50,800	24,700	N.S.
	-	21	56,800	28,100	
Spontaneous * <sup>3</sup> H	+	61	406	285	N.S.
	-	17	362	202	

Probability by Student's "t" test

Units as in Tables 2.1 and 2.3

\* Geometric Mean



Table 2.6

PAST HISTORY OF ECZEMA

	History	No.	Mean	S.D.	Probability
IgG	+	17	1,580	357	N.S.
	-	73	1,430	282	
IgA	+	17	199	79	N.S.
	-	73	201	95	
IgM *	+	17	156	66	N.S.
	-	73	147	54	
IgD *	+	17	9	24	N.S.
	-	73	13	57	
IgE *	+	17	412	1,550	<0.02
	-	73	199	320	
PHA Auto1 <sup>3</sup> H	+	16	57,000	32,200	N.S.
	-	73	76,000	37,500	
PHA F.C.S. <sup>3</sup> H	+	16	57,300	37,700	N.S.
	-	70	51,800	24,800	
Spontaneous * <sup>3</sup> H	+	16	386	265	N.S.
	-	63	396	262	

Probability by Student's "t" test

Units as in Tables 2.1 and 2.3

\* Geometric Mean

Table 2.7

HYPOSENSITIZATION THERAPY

	Therapy	No.	Mean	S.D.	Probability
IgG	+	31	1,460	335	N.S.
	-	60	1,460	281	
IgA	+	31	210	93	N.S.
	-	60	200	92	
IgM *	+	31	141	52	N.S.
	-	60	154	58	
IgD *	+	31	20	120	N.S.
	-	60	12	46	
IgE *	+	31	246	425	N.S.
	-	60	213	485	
PHA Autol <sup>3</sup> H	+	31	72,400	34,700	N.S.
	-	58	76,200	40,000	
PHA F.C.S. <sup>3</sup> H	+	30	54,600	30,300	N.S.
	-	58	51,500	26,100	
Spontaneous <sup>3</sup> H	+	29	320	285	<0.05
	-	51	422	310	

Probability by Student's "t" test

Units as in Tables 2.1 and 2.3

\* Geometric Mean

Table 2.8

IMMUNOGLOBULINS & ASTHMA CLASS

	I	II	III	IV	V
Number	9	17	14	31	20
IgG Mean	1380	1430	1400	1460	1560
S.D.	186	273	219	326	331
IgA Mean	179	198	210	176	244
S.D.	59	87	67	78	121
IgM Mean *	137	143	146	163	143
S.D.	45	63	29	49	67
IgD Mean *	11	14	16	9	13
S.D.	35	60	97	29	41
IgE Mean *	202	239	176	222	270
S.D.	950	590	305	370	495

\* Geometric Mean

I Intrinsic Asthmatics

II Intrinsic > Extrinsic

III Intrinsic - Extrinsic

IV Extrinsic > Intrinsic

V Extrinsic Asthmatics

Units as in Table 2.1

Table 2.9

<sup>3</sup>H THYMIDINE UPTAKE & ASTHMA CLASS

	I	II	III	IV	V
PHA Autol.					
No.	9	16	14	31	20
Mean	66,000	75,000	68,000	74,000	72,000
S.D.	23,000	35,000	39,000	39,000	36,000
PHA F.C.S.					
No.	9	16	14	31	20
Mean	42,000	54,000	58,000	52,000	54,000
S.D.	20,000	29,000	24,000	28,000	30,000
Spontaneous					
No.	9	14	11	29	17
Mean *	405	376	464	374	381
S.D.	233	331	387	240	130

\* Geometric Mean

Classes as defined in Table 2.8

Units as in Table 2.3

Table 2.10

DHS SKIN TEST REACTION

	Reaction	Number	Mean	S.D.	Probability
IgG	+	79	1,470	317	N.S.
	-	8	1,330	166	
IgA	+	79	200	88	N.S.
	-	8	198	124	
IgM *	+	79	149	61	N.S.
	-	8	141	28	
IgD *	+	79	12	46	N.S.
	-	8	8	35	
IgE *	+	79	227	500	N.S.
	-	8	261	415	
PHA Autol <sup>3</sup> H	+	79	73,500	37,100	N.S.
	-	8	64,600	37,400	
PHA F.C.S. <sup>3</sup> H	+	79	52,700	27,700	N.S.
	-	8	44,200	23,000	
Spontaneous * <sup>3</sup> H	+	79	396	167	N.S.
	-	8	411	252	

\* Geometric Mean

Probability by Student's "t" test

Units as in Tables 2.1 and 2.3

Table 2.11

SERUM IgE & DHS SKIN REACTIONS

	Reaction	No.	Geometric Mean	S.D.	Probability
Aspergillus	+	13	152	395	N.S.
	-	74	210	560	
Candida	+	48	143	290	<0.01
	-	39	299	870	
Mumps	+	67	171	410	N.S.
	-	20	277	490	
Old Tuberculin	+	19	194	530	N.S.
	-	68	198	500	
"Varidase"	+	61	187	540	N.S.
	-	26	234	470	

Probability by Student's "t" test

IgE: units/ml

Table 2.12

PIGEON RED CELL CYTOTOXICITY

	Subject	% Release *
Controls	1	38
	2	39
	3	22
	4	32
	5	30
	6	31
	7	24
	8	23
Asthmatics		
Skin Test positive	1	22
Asthmatics		
Skin test negative	1	26
	2	33
	3	25
	4	32
Lymphoma	1	14

\* PHA Stimulated % Release - Unstimulated % Release

Table 2.13

TETANUS RESPONSE

	Response	No.	Mean	S.D.	Probability
IgG	+	60	1,440	356	N.S.
	-	13	1,490	248	
IgA	+	60	190	77	<0.02
	-	13	260	86	
IgM *	+	60	148	60	N.S.
	-	13	156	83	
IgD *	+	60	13	69	N.S.
	-	13	14	61	
IgE *	+	60	252	567	N.S.
	-	13	197	434	
PHA Auto1 <sup>3</sup> H	+	60	68,100	34,300	N.S.
	-	13	62,400	38,800	
PHA F.C.S. <sup>3</sup> H	+	57	54,500	28,800	<0.005
	-	13	36,400	14,500	
Spontaneous *	+	54	400	226	<0.01
	-	11	208	241	

\* Geometric Mean

Units as in Tables 2.1 and 2.3

Probability by Student's "t" test



Table 2.14

EOSINOPHIL LEVELS

	Number	Geometric Mean	S.D.	Probability
Controls	90	40	310	<0.001
Asthmatics	91	228	880	
Class 1	9	239	4000	
" 2	17	208	1000	
" 3	14	142	650	
" 4	31	261	770	
" 5	20	278	320	

Eosinophils /  $\mu$ L

Probability by Student's "t" test

Asthma classes as in Table 2.8

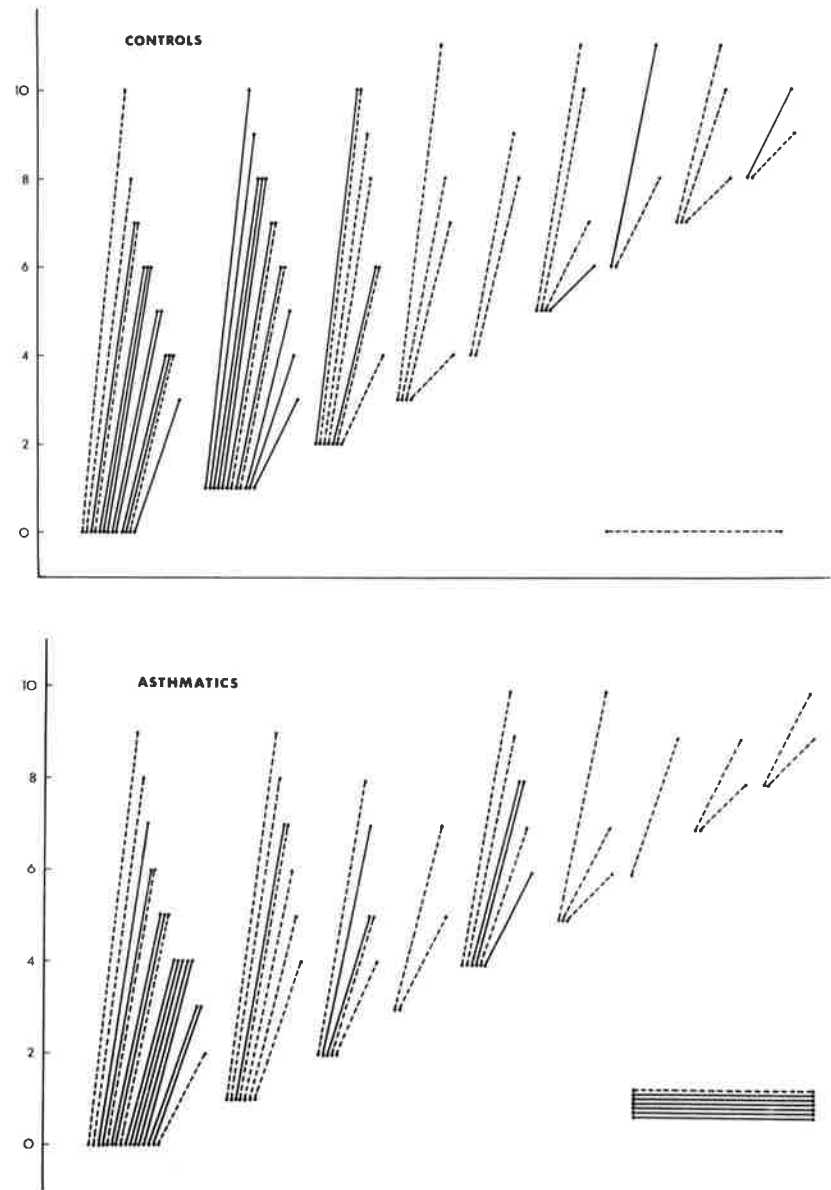

Fig. 2.1 Titres of antibody to tetanus toxoid before and after immunization. Each solid line represents two patients and each broken line one patient, with dot on the left being pre-immunization titre and that on the right representing post-immunization titre. Titre is  $\log_2$  of reciprocal of highest dilution at which haemagglutination was observed.

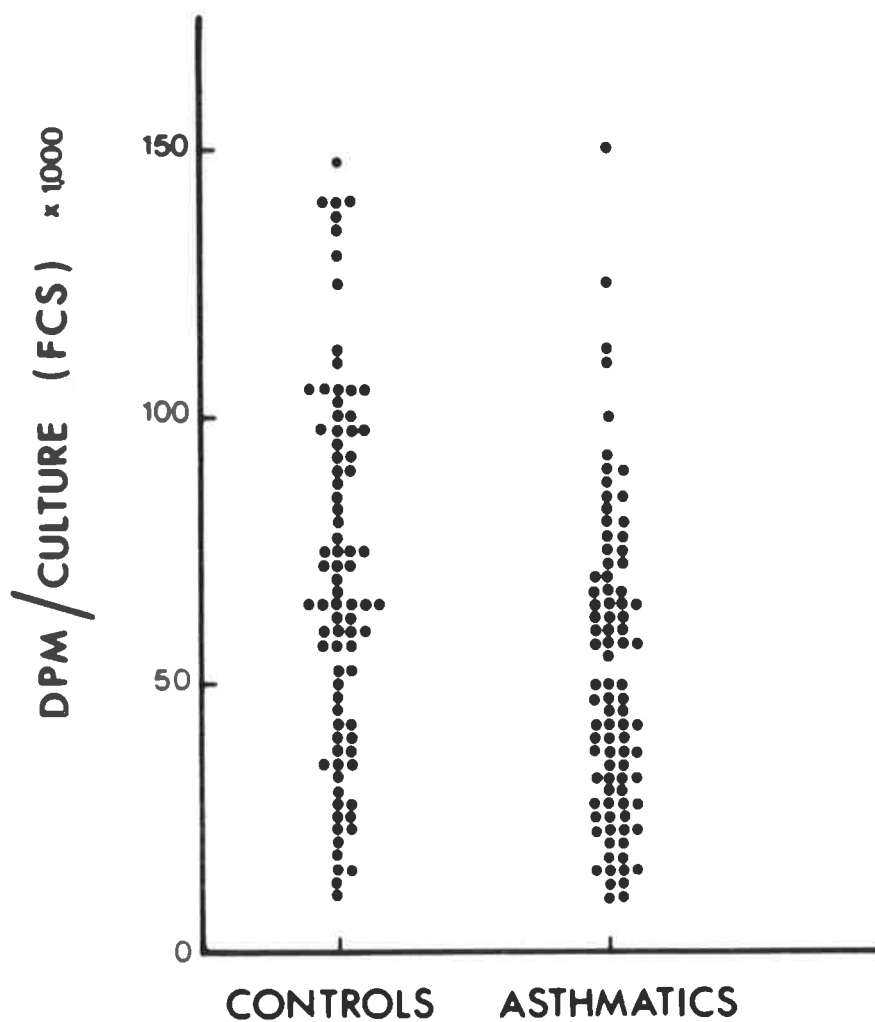

Fig. 2.2 Individual values for  $^3\text{H}$  thymidine uptake (disintegrations per minute per culture) of lymphocytes in foetal calf serum for asthmatics and controls.

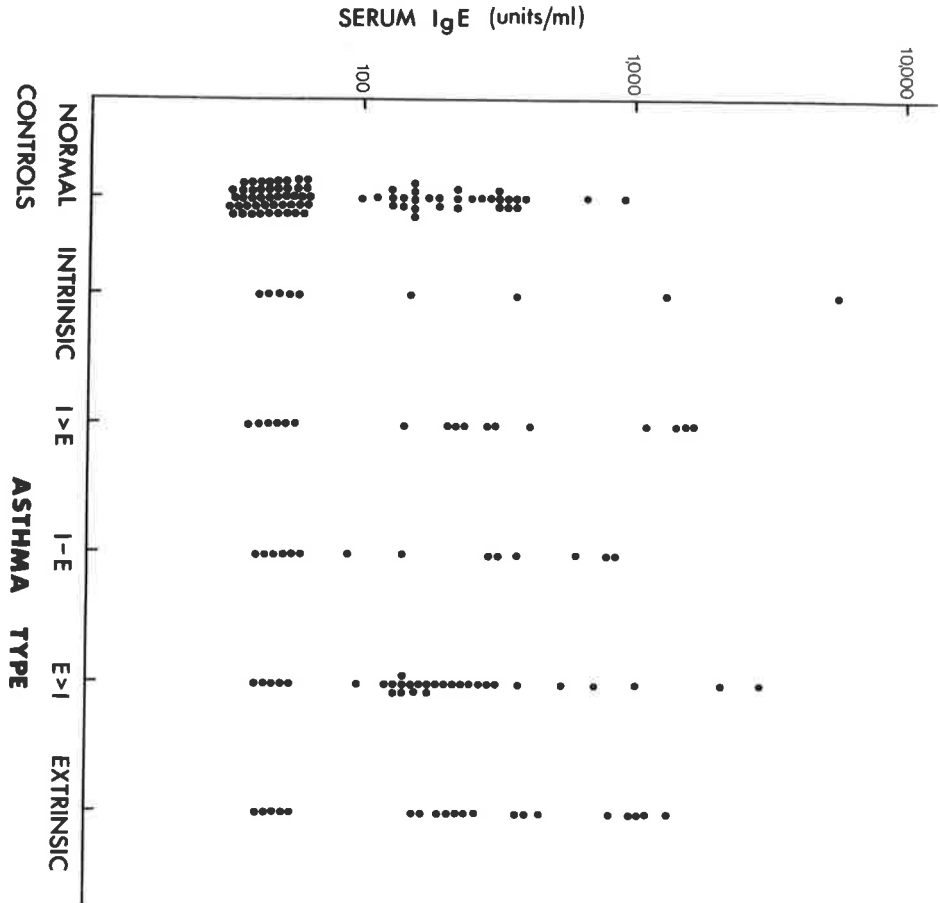

Fig. 2.3 Serum IgE values (units/ml) plotted on a logarithmic scale for normal controls and patients in each asthma class.

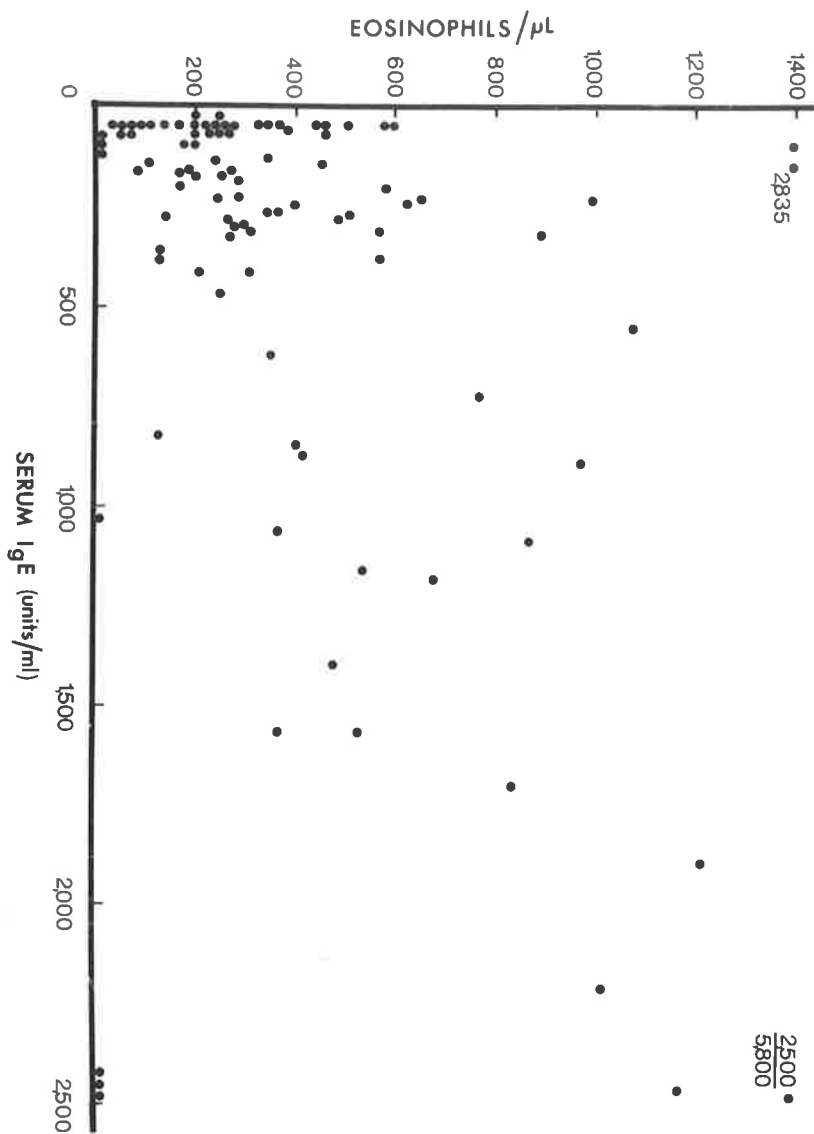

Fig. 2.4 The absolute eosinophil count plotted against the serum IgE value for each patient.

## DISCUSSION

These results provide evidence of impairment of antibody production or cellular immune processes in some patients with asthma. It is proposed that diminished function may be related to the pathogenesis of asthma.

Although the opportunity did not arise in all cases to demonstrate airways obstruction reversible with bronchodilators, all cases had clinical features consistent with the diagnosis of asthma. Patients were selected only inasmuch as that they had been referred to an allergist for management. Most patients were reasonably well at the time of study, many of them having presented for review or during a course of hyposensitization treatment.

Many attempts have been made to classify asthma (Williams, 1964). Rackemann (1918) was probably one of the first people to differentiate asthma into intrinsic and extrinsic types. Many modern authors still use this classification (for example, Henderson et al., 1971; Johansson et al., 1970; Kumar et al., 1971; Rowe and Wood, 1970; Schwartz et al., 1968; Turner-Warwick and Haslam, 1970). Moreover, as discussed later, differences in IgE levels and the prevalence of smooth muscle antibodies are claimed for these types. Accordingly an attempt was made to classify patients in this way. As a sharp distinction could often not be made, it was considered preferable to grade the patients into five classes, passing from most intrinsic to

most extrinsic, thus allowing trends to become apparent.

Most workers have found little difference between mean levels of IgG, IgA and IgM in control and allergic patients (Johansson, 1967; Huntley et al., 1963; Momma, 1965; Buckley et al., 1968; Collins-Williams et al., 1967). In contrast, patients in this series had a raised mean IgG level. Patients without a family history of atopy however, did not have significantly elevated IgG levels. Normal levels of IgA and IgM were seen in this study. Kaufman and Hobbs (1970) demonstrated that 7% of atopics had very low immunoglobulin levels, this finding being most marked with IgA. In this series, no patients had an IgG or IgM reading below the normal range, while serum IgA was not detectable in one patient.

Only 27% of patients had IgE levels above the normal range. This proportion is less than that found by some workers, but is similar to the findings of Kumar et al (1971a) working with children. It is possible that the levels were low because the study was carried out in winter when allergenic stimulation may have been less. Johansson (1967), Berg and Johansson (1969), Rowe and Wood (1970) and Kumar et al (1971b) reported raised levels of IgE in extrinsic, but not in intrinsic asthmatics. No significant differences were apparent between any of the five classes of asthmatics in this series. This finding is in agreement with the observation of Henderson et al (1971) who found

that 21% of intrinsic asthmatics had raised IgE levels. Similarly, Reerink-Brougers et al (1973) found that IgE levels were not helpful in differentiating intrinsic from extrinsic asthmatics. Rackemann (1958) concluded that clinical evidence "gives strong support to the idea that these diseases are all the same". Raised IgE levels in both intrinsic and extrinsic asthmatics are consistent with the hypothesis that there is a final common reaginic pathway.

Serum IgE levels have been found to be higher in atopic eczema than in asthma (Johansson et al., 1970; Wood and Oliver, 1972). The higher IgE levels in patients with a past history of eczema are consistent with this observation.

There was a significant correlation between the absolute eosinophil count and the IgE level, but like the IgE levels, no differences in eosinophilia were found between any of the asthma classes.

Turner-Warwick and Haslam (1970) found smooth muscle antibodies in 20% of patients with intrinsic asthma. In this series, there was no difference in frequency from the normal population, and those subjects who were positive, had extrinsic features. These findings are similar to those of Reerink-Brougers et al (1973) who also found that smooth muscle antibodies, like IgE levels, are not helpful in differentiating intrinsic from extrinsic asthmatics.

Impaired cellular immunity was demonstrated by absent



DHS skin reactions in some patients. The mean serum IgE level of the non-reactors to each antigen was higher than that of the reactors, although this difference was significant only for candida antigen. This may be evidence of increased reaginic stimulation secondary to impairment of the cell-mediated immune system.

It is generally recognized that lymphocyte responsiveness to PHA is an index of cellular immunity (Ling, 1968). The  $^3\text{H}$  thymidine uptake was within normal limits when the lymphocytes were cultured in autologous serum, but depressed when cultured in foetal calf serum, this occurring in each asthma class. If drugs were to affect lymphocyte activity significantly, more profound depression of transformation would be expected in lymphocytes which were cultured in autologous rather than foetal calf serum. In any case, analysis of the data showed that PHA-induced  $^3\text{H}$  thymidine uptake in patients taking drugs was not significantly different from that in untreated asthmatics. The significance of the finding is obscure. It is possible that the depressed uptake may simply represent an altered kinetic or dose response to PHA rather than an inherent defect of lymphocytes. Alternatively, the reduced uptake in foetal calf serum may be the result of intrinsic hyporeactivity of lymphocytes in asthmatics, with the normal uptake in autologous serum due to less of a postulated inhibitor of lymphocyte activity (Field and Caspary, 1971; Ford et al., 1973) in the serum of asthmatics.

Impairment of cellular immunity was shown by the failure of eight asthmatics to make DHS reactions to any of the test antigens. PHA-stimulated lymphocyte transformation was reduced in these patients, but not at a statistically significant level. There were however, only small numbers in this group. Supportive evidence of impaired cellular immunity in this group is given by the results of DNCB testing. Four of these patients were tested and three could not be sensitized. Five patients were skin tested with PHA and all reacted normally. Impairment of cellular immunity was further investigated by assessment of a cytotoxic factor produced by PHA-stimulated lymphocytes. Cytotoxicity was measured by the release of  $^{51}\text{Cr}$  from pigeon red cells. PHA stimulation of a cytotoxic factor did not differ between DHS skin test positive asthmatics, DHS skin test negative asthmatics and normals. The technique was sufficiently sensitive to show impaired production in a lymphoma patient with gross depression of cellular immunity. It seems unlikely that nonspecific response to PHA mitogen is impaired in this group of asthmatics. Some patients however, seem to have an impaired cell-mediated response to a specific antigenic stimulus.

Eighteen percent of asthmatics failed to make antibodies after immunization with tetanus toxoid, this usually being an IgG secondary response. This represents not merely failure to increase the titre, but failure to produce

any detectable antibodies. There is however, not a complete block in antibody production, for ten non-responders produced antibody after re-immunization. This phenomenon has been observed previously in people suffering from chronic infections (Forbes, 1971). It is probable that this test is a relatively sensitive indicator of humoral immunological competence.

Other workers have assessed the humoral immune response in asthma. Kuhns and Pappenheimer (1952) described an asthmatic boy who produced reaginic but not precipitating antibodies to diphtheria toxoid, and three non-atopic subjects who failed to produce precipitating antibodies despite high titres of reaginic antitoxin. Leskowitz and Lovell (1961) did not demonstrate any differences in the capacity of atopics and non-atopics to produce precipitating antibodies on immunization with dextran and pneumococcal polysaccharide administered parenterally. The failure of response to tetanus toxoid, but normal response to S. typhi H antigen, in this series may reflect a different population of asthmatics, difference in the antigen, or represent production of antibody with reduced affinity for tetanus toxoid. These findings may be analagous to those in mice in which the secondary response to tetanus toxoid is thymus-dependent (Hess, 1968), whereas antibody responses to *Salmonella* flagellar antigen are less thymus-dependent and those to pneumococcal polysaccharide are thymus-independent

(Davies et al., 1970).

Other abnormalities were present in the group of tetanus non-responders: the serum IgA level was raised; the PHA-stimulated uptake of lymphocytes cultured in foetal calf serum was even more depressed; and there was a reduced spontaneous lymphocyte  $^3\text{H}$  thymidine uptake. These data show that tetanus non-response is not simply an isolated defect in these patients. A limited family study suggested a role for inheritance in tetanus non-responsiveness. Four of 41 relatives failed to respond to immunization, compared with an expected frequency of 1%. In one family, three sisters were tested, and all failed to respond.

The spontaneous lymphocyte  $^3\text{H}$  thymidine uptake probably reflects the circulating population of lymphocytes responding to antigenic stimulation (Wood and Frankel, 1967; Crowther et al., 1969). Although the overall spontaneous  $^3\text{H}$  uptake was normal, it was reduced in two subpopulations. It was reduced in tetanus non-responders. It is of interest that the same phenomenon was seen in those patients with dystrophia myotonica who failed to respond to tetanus immunization (Chapter VIII). It was also reduced in those patients who were undergoing hyposensitization therapy. There was however, no greater prevalence of tetanus non response in those patients undergoing such therapy. The significance of these findings is unclear.

The data presented support the hypothesis that in some

asthmatics there are deficiencies in the immunological defence mechanisms, humoral or cellular. This may lead to increased antigenic stimulation of the reaginic system. This has also been postulated by Soothill and Steward (1973) who suggest that reaginic may result from "defective antibody response leading to abnormal handling of antigen". Further support is given by the observations of Taylor et al (1973) who have shown that transient IgA deficiency in infancy may be associated with the subsequent development of atopy in the children of reaginic parents.

Reaginic antibodies can be induced in almost every individual under the appropriate circumstances (Leskowitz and Lowell, 1961; Salvaggio et al., 1964, 1969; Schwartz and Terr, 1971; Greenert et al., 1971). The factors which determine these circumstances may be higher intrinsic activity of the reaginic system, or relative inefficiency of the other humoral or cellular immune mechanisms. These two systems may be each subject to genetic influences. The great range in severity of clinical asthma may, in part, reflect the interaction of these factors. There may be many varieties of immunological deficiency which have as their common response, a clinical presentation as one of the atopic diseases.

## SUMMARY

Parameters of humoral and cellular immunity have been measured in 91 asthmatics. Mean serum levels of IgG and IgE were raised. IgG levels were higher in those with a family history of atopy. IgE levels were higher in those with a past history of eczema. There was a correlation between serum IgE levels and the absolute eosinophil count. Thirteen of 74 patients failed to respond to tetanus immunization, while only one failed to respond to S. typhi H antigen. Tetanus non-responders had a raised mean serum IgA level, reduced spontaneous lymphocyte tritiated thymidine uptake, and reduced thymidine uptake of PHA-stimulated lymphocytes cultured in foetal calf serum. Eight of 87 patients failed to mount delayed hypersensitivity reactions to a battery of five intradermal antigens. Three of four such patients could not be sensitized with DNCB. The tritiated thymidine uptake of lymphocytes stimulated with phytohaemagglutinin was normal in autologous serum, but reduced in foetal calf serum.

Intrinsic and extrinsic asthma could not be differentiated on the basis of IgE levels, the absolute eosinophil count, smooth muscle antibodies, DHS reactions, tetanus antibody response or lymphocyte tritiated thymidine uptake. The data support the hypothesis that, in some patients, asthma may be associated with immunodeficiency states.

## CHAPTER III

### IMMUNE FUNCTION IN ASTHMATICS TREATED WITH CORTICOSTEROIDS

Introduction	96
Results	96
Discussion	102
Summary	103

## INTRODUCTION

Glucocorticoids have a suppressive effect on allergic reactions (Jasani, 1972). Parameters of humoral and cellular immunity were measured as previously described in patients who were receiving steroid therapy. Most of these subjects were hospital inpatients or outpatients. All were taking 10 mg or more of prednisolone or its equivalent daily. The mean age was 36 years with a standard deviation of 12 years. Approximately half of the subjects were males and half females.

Results were compared with those obtained from asthmatic patients not receiving corticosteroid therapy.

## RESULTS

### Immunoglobulin Levels

Although the IgE levels were marginally higher, there were no significant differences for any of the five major immunoglobulin classes when compared with asthmatics not receiving corticosteroids (Table 3.1).

### Antibody Responses

Antibody titres were measured before and after immunization in ten asthmatics. Haemagglutinating antibodies to tetanus toxoid were not detectable in 40% of subjects compared with 18% of asthmatics not receiving corticosteroid therapy (Table 3.2). This difference is not



statistically significant. Precipitating antibodies to S. typhi H antigen are also shown in Table 3.2. There is a suggestion of a bimodal response, with a group of poor responders and a group which responded well, but the numbers are small.

#### DHS Reactions

DHS reactions were measured in ten patients (Table 3.3). The four subjects receiving a daily dose of 30 mg or more of prednisolone failed to react to any antigen. Two of the six patients receiving between ten and twenty mg prednisolone daily failed to react to any of the antigens.

#### Lymphocyte <sup>3</sup>H Thymidine Uptake

PHA-stimulated lymphocyte <sup>3</sup>H thymidine uptake in both autologous and foetal calf serum was grossly depressed (Table 3.1, Fig. 3.1). Conversely, the spontaneous lymphocyte <sup>3</sup>H thymidine uptake was significantly increased (Table 3.1, Fig. 3.1).

Table 3.1

IMMUNOGLOBULIN LEVELS & LYMPHOCYTE <sup>3</sup>H UPTAKE

Asthmatics treated with steroids compared with  
asthmatics not being treated with steroids.

	Steroids	No	Mean	S.D.	Probability
IgG	+	12	1,288	420	N.S.
	-	91	1,460	304	
IgA	+	12	189	79	N.S.
	-	91	197	77	
IgM	+	12	149*	56	N.S.
	-	91	149*	56	
IgD	+	12	5.5*	9	N.S.
	-	91	12	47	
IgE	+	12	290*	380	N.S.
	-	91	225*	480	
Eosinophils	+	11	68*	2,480	N.S.
	-	91	228*	880	
PHA <sup>3</sup> H Uptake - autol serum	+	18	23,100	19,000	<0.001
	-	90	73,000	37,700	
PHA <sup>3</sup> H Uptake - FCS	+	18	14,200	14,000	<0.001
	-	90	52,500	27,600	
Spontaneous <sup>3</sup> H Uptake	+	16	900*	702	<0.001
	-	80	392*	299	

Units as in Tables 2.1 and 2.3

\* Geometric Mean

Probability by Student's "t" test

Table 3.2

ANTIBODY RESPONSES

Asthmatics treated with steroids compared with  
asthmatics not being treated with steroids.

Tetanus Antibody Response

	Responders	Non-Responders	Probability*
Steroids +	6	4	N.S.
Steroids -	61	13	

\* Probability by Fishers Exact Test

Typhoid Antibody Response

Titre	0	10	20	40	80	160	320	640	Total
Steroids +	1	2	0	0	0	0	1	6	10
Steroids -	1	0	4	4	7	14	13	31	74

Table 3.3

DHS SKIN TESTS

DHS Skin Tests to the five antigens were performed on ten patients.

	<u>Prednisolone Dose</u> (mg/day)	<u>Positive Reactions</u> (number)
1.	10	0
2.	10	2
3.	10	3
4.	15	0
5.	20	1
6.	20	2
7.	30	0
8.	60	0
9.	60	0
10.	60	0

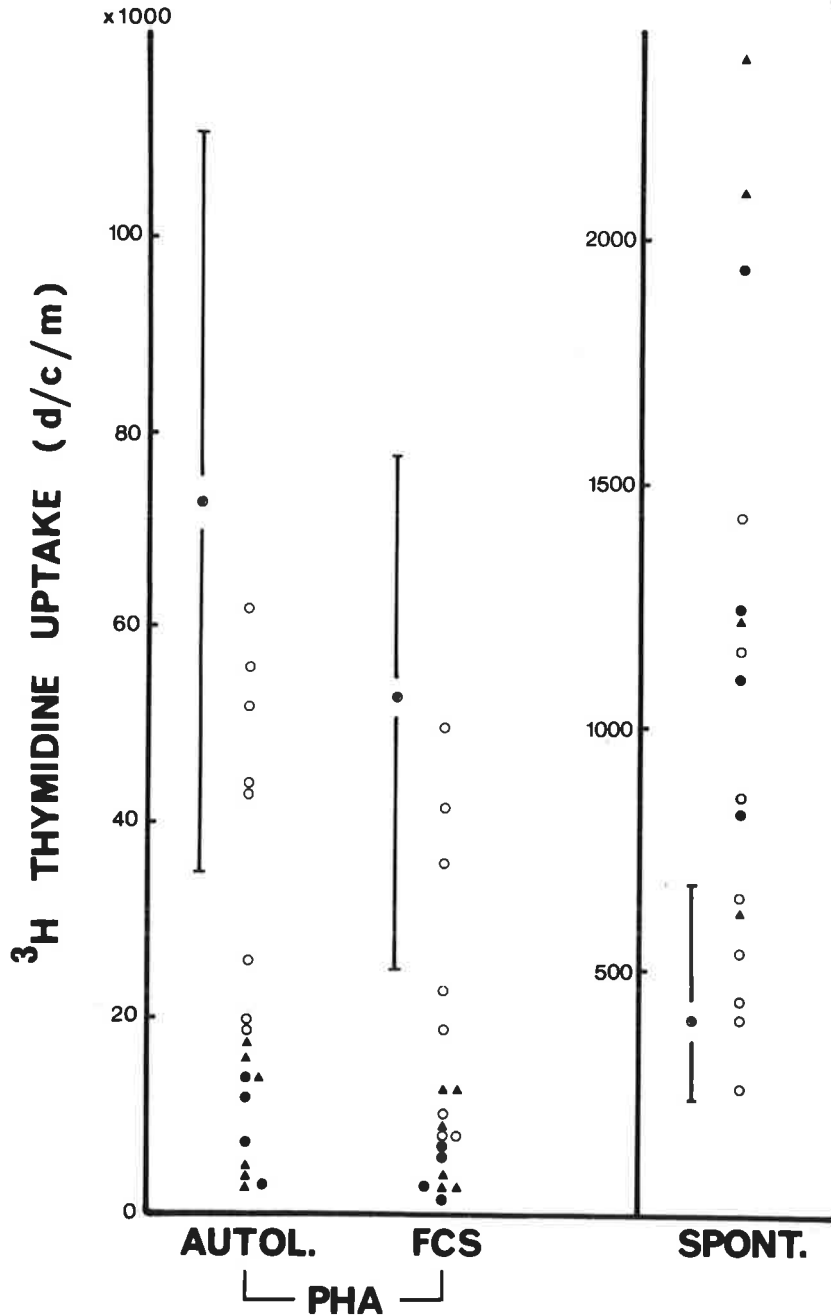

Fig. 3.1 Lymphocyte  $^3\text{H}$  thymidine uptake stimulated with PHA, in the presence of autologous and foetal calf serum, and spontaneously. o represents patients receiving 10-20 mg of prednisolone daily, • 25-35 mg of prednisolone daily and Δ 40 mg or more of prednisolone daily. |—•—| represents mean and standard deviation for asthmatics not receiving corticosteroids.

## DISCUSSION

Serum immunoglobulin levels were not significantly different in asthmatics being treated with corticosteroids, nor did this therapy appear to have a critical effect on antibody production. Sixty percent of these patients did respond to tetanus immunization, and only one subject failed to respond to S. typhi H antigen. This marginal depression of antibody responsiveness is consistent with animal experiments which have shown that timing and dosage of corticosteroids, together with type and strength of antigen, are important in determining whether steroids suppress antibody formation (Jasani, 1972).

The depression of lymphocyte  $^3\text{H}$  thymidine uptake when stimulated with PHA accords with the observations of others (Ling, 1968). The depression of DHS skin reactions, particularly when a dose of more than 20 mg of prednisolone daily was being given, is consistent with this finding:

There was a significant elevation of the spontaneous lymphocyte  $^3\text{H}$  thymidine uptake. As noted previously, this parameter probably reflects the circulating population of lymphocytes reacting to antigenic stimulation (Wood and Frenkel, 1967; Crowther et al., 1969). The increased uptake may represent increased immunological activity associated with more severe clinical disease or response to secondary infection, although there is evidence that corticosteroid therapy increases  $^3\text{H}$  thymidine uptake by

causing an outpouring of immature myeloid cells from the marrow (Dimitriu et al., 1971).

These findings show the same general features as those observed in asthmatics not treated with corticosteroids. It is difficult to discern whether the underlying immune deficiency before corticosteroid therapy is worse in this group or whether some responses, notably DHS skin reactions and lymphocyte stimulation with PHA, have been further depressed by the effect of corticosteroid treatment.

#### SUMMARY

Parameters of immunological function have been assessed in asthmatic patients receiving corticosteroid therapy. There were no significant differences in immunoglobulin levels when compared with asthmatics not receiving corticosteroids. Antibody responses to tetanus and typhoid antigens were marginally weaker. DHS skin reactions were suppressed with high doses of corticosteroids. PHA-stimulated lymphocyte  $^3\text{H}$  thymidine uptake was grossly depressed while the spontaneous uptake was elevated.

These findings are consistent with those observed in asthmatics, although some responses have been further depressed by the effects of corticosteroid therapy.

## CHAPTER IV

### HUMORAL AND CELLULAR IMMUNITY IN ATOPIC ECZEMA

Introduction	104
Patients	105
Control Subjects	106
Methods	106
Results	107
Discussion	118
Summary	121



## INTRODUCTION

The demonstration of humoral or cellular immune deficiency in some patients with asthma suggested the extension of these investigations to patients with atopic eczema. In addition, two other observations suggested the possibility of immunodeficiency in atopic eczema.

Firstly, Kaposi's varicelliform eruption has long been recognized as a clinical entity which usually results from infection with herpes simplex or vaccinia viruses in patients with atopic eczema (Rook et al., 1972) suggesting that defence mechanisms are impaired. Moreover, many patients with eczema vaccinatum respond to hyperimmune anti-vaccinial gamma globulin (Sharp and Fletcher, 1973).

Secondly, as mentioned in Chapter II, Rostenberg and Sulzberger (1937) showed that patients with atopic dermatitis were much less likely to produce a delayed hypersensitivity reaction on patch testing than patients with contact dermatitis. Since that time there has been considerable controversy over the prevalence of contact dermatitis in patients with atopic dermatitis. A Scandinavian committee tested 1,027 patients with a routine series of patch tests and found that 13% of atopics and 31% of non-atopics had positive reactions (Magnusson et al., 1969). Calnan (1956) and Caron (1964) found little evidence of atopy in nickel-sensitivity. Skog and Thyresson (1953), Wilson (1955), Baer (1959), Jillson et al (1959), Fregert and

Moller (1963) and Cronin et al (1970) concluded that atopic individuals were no more likely to develop contact dermatitis than normal persons. In contrast, Epstein and Mohajerin (1964), Epstein (1965) and Forsbeck et al (1967) thought that there was a positive relationship between atopy and contact dermatitis. The relevance of these observations is that if some patients with atopic dermatitis have a cellular immune defect, the prevalence of contact dermatitis in such people may be expected to be reduced. Demonstration of such a negative relationship may be obscured however, as people with atopic eczema usually have a much greater exposure to topical medicaments and any damaged skin is more likely to develop a contact dermatitis (Rook et al., 1972). Some of the studies cited are thus consistent with the hypothesis that some patients with atopic eczema have associated immunodeficiency.

Tests of humoral and cellular immunological function were therefore performed in some patients with atopic eczema and the results compared with those found in normal control subjects.

### PATIENTS

Twelve male and twenty three female patients were studied. Ages ranged from five to 64 years with one patient in the first decade and 6, 18, 6, 1, 2 and 1 patients in each succeeding decade.

All patients had been referred to a dermatologist (Dr. J.G. Reid) who had diagnosed them as suffering from atopic dermatitis on the basis of the clinical history and morphology and distribution of the lesions. Patients either had the typical flexural eczematous lesions with lichenification or atypical dermatitis with a definite past history of classical infantile eczema, plus a past or family history of asthma or hay fever.

#### CONTROL SUBJECTS

Control values were established on normal subjects with a similar age and sex distribution to the patients studied.

As an additional control, lymphocyte  $^3\text{H}$  thymidine uptakes were measured in patients with psoriasis some of whom were receiving topical corticosteroid therapy.

#### METHODS

Serum immunoglobulin and eosinophil levels, antibody responses to immunization with tetanus toxoid and typhoid vaccine, DHS reactions to candida, mumps and streptococcal antigens, lymphocyte  $^3\text{H}$  thymidine uptake and T and B lymphocyte levels were measured as previously described.

## RESULTS

### Immunoglobulin Levels

IgE levels were raised in patients with atopic eczema, while levels of IgG, IgA, IgM and IgD were normal (Table 4.1). Thirty seven percent of patients had IgE levels above the normal range.

### Antibody Responses

Antibody titres were measured before and after immunization in 31 patients with atopic eczema. Haemagglutinating antibodies to tetanus toxoid were not detectable in 3 (10%) of patients. Each patient was age and sex matched with two controls, all of whom responded to immunization. This difference was significant ( $P < 0.04$ , Fisher's Exact Test).

Precipitating antibodies to S. typhi H antigen were found in all patients and controls.

### Delayed Hypersensitivity Reactions

DHS reactions were measured in 35 patients. Fourteen percent failed to react to any antigen, compared with no such failure in the controls (Table 4.2). This difference was significant ( $P < 0.03$ , Fisher's Exact Test).

When the total number of reactions to the three antigens was compared, the depression of reaction in patients was more significant ( $P < 0.001$ ). Atopic eczema patients

reacted to 55%, while controls to 73% of the tests performed.

#### Lymphocyte Tritiated Thymidine Uptake

The uptake of  $^3\text{H}$  thymidine by lymphocytes is shown in Table 4.3. There were no significant differences in uptake, either spontaneously or stimulated with PHA when cultured in either autologous or foetal calf serum.

Twenty two patients were using betamethasone cream, while 12 were not using any steroid preparation. There were no differences for any of the three parameters between the two groups (Table 4.4). Similarly, there was no difference in PHA-stimulated uptake by psoriatic patients using and not using steroid preparations (Table 4.5). It is of interest that psoriatic patients had a considerably reduced uptake compared with that of the controls of the atopic eczema patients. This may be a reflection of psoriasis itself, or the greater age of these patients (mean 50 years versus mean 27 years).

There were no significant differences in the PHA-stimulated uptake of DHS non-reactors compared with DHS reactors (Table 4.6). There was however, a significantly elevated spontaneous uptake by DHS non-reactors.

### T and B Lymphocytes

There were no significant differences in either the absolute lymphocyte count, T cell numbers, or total IgG, IgA and IgM B cell numbers (Table 4.7). IgM B cell levels were elevated in patients who failed to make DHS reactions when compared with those who did respond (Table 4.8), but were not significantly different from the 33 normal subjects in Table 4.7.

### Eosinophils

There was a significantly higher eosinophil count in patients with atopic eczema when compared with controls (Table 4.7).

Table 4.1

SERUM IMMUNOGLOBULIN LEVELS

		Number	Mean	S.D.	Probability
IgG	Patients	35	1460	320	N.S.
	Controls	35	1560	325	
IgA	Patients	35	166	60	N.S.
	Controls	35	195	77	
IgM	Patients	35	172*	73	N.S.
	Controls	35	170*	66	
IgD	Patients	35	12*	99	N.S.
	Controls	35	13*	80	
IgE	Patients	35	348*	1780	<0.001
	Controls	35	100*	107	

Probability by "t" test

\* Geometric Mean

IgG, IgA, IgM: mg/100 ml

IgD, IgE: units/ml

N.S. = Not Significant

Table 4.2

DELAYED HYPERSENSITIVITY REACTIONS

(a) Patients who Reacted to at Least One Antigen

	Reactors	Non Reactors	Probability
Patients	30	5	<0.03
Controls	35	0	

(b) Total Number of Reactions to the Three Antigens

	Positive Reactions	Negative Reactions	Probability
Patients	58	47	<0.001
Controls	77	28	

Probability by Fisher's Exact Test See Appendix p. 223



Table 4.3

LYMPHOCYTE  $^3\text{H}$  THYMIDINE UPTAKE †

		Number	Mean	S.D.	Probability
PHA $^3\text{H}$ Uptake - autol.	Patients	34	51,000	26,000	N.S.
	Controls	34	55,800	27,000	
PHA $^3\text{H}$ Uptake - F.C.S.	Patients	30	58,000	22,000	N.S.
	Controls	30	51,500	20,000	
Spontaneous $^3\text{H}$ Uptake	Patients	35	420*	470	N.S.
	Controls	35	376*	155	

† Disintegrations per culture per minute

\* Geometric Mean

Probability by "t" test

N.S. = Not Significant

Table 4.4

BETAMETHASONE and LYMPHOCYTE  $^3\text{H}$   
THYMIDINE UPTAKE †

	Betameth- asone	Number	Mean	S.D.	Probability
PHA $^3\text{H}$ Uptake autol.	+	22	49,500	25,000	N.S.
	-	12	53,900	26,000	
PHA $^3\text{H}$ Uptake F.C.S.	+	20	57,400	23,000	N.S.
	-	10	61,600	21,000	
Spontaneous $^3\text{H}$ Uptake	+	22	456*	580	N.S.
	-	12	360*	270	

† Disintegrations per culture per minute

\* Geometric Mean

Probability by "t" test

N.S. = Not Significant

Table 4.5

BETAMETHASONE and LYMPHOCYTE <sup>3</sup>H THYMIDINE  
UPTAKE in PSORIASIS †

	Betameth- asone	Number	Mean	S.D.	Probability
PHA <sup>3</sup> H Uptake	+	23	39,000	18,000	N.S.
- autol serum	-	16	45,500	24,000	
PHA <sup>3</sup> H Uptake	+	22	33,000	17,000	N.S.
- F.C.S.		13	41,000	22,000	

† Disintegrations per culture per minute

Probability by "t" test

N.S. = Not Significant

Table 4.6

DHS REACTION and LYMPHOCYTE<sup>3</sup>H THYMIDINE UPTAKE †

		Reaction Number	Mean	S.D.	Probability
PHA <sup>3</sup> H Uptake	+	30	50,000	24,000	N.S.
	-	4	59,000	36,000	
Autol.	-				
PHA <sup>3</sup> H Uptake	+	25	58,000	22,000	N.S.
	-	5	59,000	24,000	
F.C.S.	-				
Spontaneous	+	30	360*	230	<0.001
	-	5	1290*	830	
<sup>3</sup> H Uptake	-				

† Disintegrations per culture/minute

\* Geometric Mean

Probability by "t" test

N.S. = Not Significant

Table 4.7

T and B LYMPHOCYTES: EOSINOPHILS †

		Number	Mean	S.D.	Probability
Lymphocytes	Patients	34	1950	750	N.S.
	Controls	34	1840	410	
T Cells	Patients	34	920	490	N.S.
	Controls	34	910	350	
B Cells	Patients	34	280	175	N.S.
	Controls	34	220	100	
IgG	Patients	33	170	100	N.S.
	Controls	34	140	60	
IgA	Patients	33	74	56	N.S.
	Controls	34	78	48	
IgM	Patients	33	150	100	N.S.
	Controls	34	150	80	
Eosinophils	Patients	34	160*	1500	<0.01
	Controls	34	42*	500	

† cells/ $\mu$ l

\* Geometric Mean

Probability by "t" test

N.S. = Not Significant

Table 4.8

DHS REACTION and T and B LYMPHOCYTES †

	DHS Reaction	Number	Mean	S.D.	Probability
T Cells	-	5	748	387	N.S.
	+	29	945	506	
B Cells Total	-	5	316	169	N.S.
	+	29	278	176	
IgG	-	5	198	102	N.S.
	+	28	165	95	
IgA	-	5	76	63	N.S.
	+	28	74	54	
IgM	-	5	234	141	<0.05
	+	28	130	91	

† cells per  $\mu$ l

Probability by "t" test

N.S. = Not Significant

## DISCUSSION

These results are similar to those found in asthmatic patients, in that there is evidence of impairment in cellular or humoral immune processes in some patients with atopic eczema. However, there are variations in the frequencies of different abnormalities. These may be chance occurrences or related to the different clinical manifestations of atopy.

The mean IgE level was elevated as has been shown in other studies (Juhlin et al., 1969; Ogawa et al., 1971; Gurevich et al., 1973; Stone et al., 1973). This elevation was greater than that seen in the asthmatic patients (Chapter II). This has also been observed by Johansson et al (1970) and Wood and Oliver (1972). In contrast to the findings in the asthmatic patients, IgG levels were not significantly elevated. Raised IgG levels in atopic eczema were found however by Varelzidis et al (1966).

Ten percent of patients failed to respond to immunization with tetanus toxoid. This compares with a failure of response in 18% of asthmatic subjects. There were insufficient subjects to determine whether, as in asthmatics, tetanus non-responders had other immunological abnormalities.

Fourteen percent of patients failed to make DHS reactions to intradermal antigen compared with nine percent

of the asthmatics. There was also a significant reduction in the total number of reactions to antigens compared with normal subjects. This finding is consistent with those studies which have suggested that there are less patch test reactions in atopics compared with non-atopics (Caron, 1962; Magnusson et al., 1969). It supports the observations of Rajka (1963, 1970) who demonstrated that delayed reactions to bacterial and viral extracts were impaired in atopic eczema.

No abnormalities of lymphocyte  $^3\text{H}$  thymidine uptake were seen in patients with atopic eczema. Similarly, Fjelde and Kopecka (1967) did not demonstrate a significant reduction in PHA-stimulated lymphocyte transformation assessed morphologically. This contrasts with the findings in asthmatic patients who had a reduced phytohaemagglutinin-stimulated uptake in the presence of foetal calf serum. It is of interest that asthmatic patients with a positive past history of eczema had less depression of uptake in foetal calf serum than those without such a history, although this was not a significant difference (Table 2.6). The significance of this finding is obscure.

No significant differences were observed in lymphocyte  $^3\text{H}$  thymidine uptake between those patients who were receiving topical corticosteroid therapy and those without such therapy. Confirmatory evidence was provided by the failure to demonstrate any significant effect of topical



corticosteroid therapy on lymphocyte  $^3\text{H}$  thymidine uptake in patients suffering from psoriasis.

The phytohaemagglutinin-stimulated lymphocyte  $^3\text{H}$  thymidine uptake was not reduced in patients with negative DHS reactions but, even though the numbers were small, there was a significant elevation of the spontaneous lymphocyte  $^3\text{H}$  uptake. This feature is similar to the raised spontaneous uptake in asthmatic patients being treated with corticosteroids, many of whom had negative DHS reactions.

There were no striking abnormalities in the T or B lymphocyte numbers. Although there was an increase in the number of IgM-bearing B cells in the patients who failed to make DHS reactions compared with reactors, the number of patients in the group is small. Moreover, the elevation was not significant when compared with normal controls.

Support for the concept of immunodeficiency in atopic dermatitis has also been given by the observations of Lobitz et al (1972). They reported two adult patients with atopic dermatitis who had depressed cell-mediated immunity as evidenced by impaired delayed hypersensitivity reactions on skin testing, inability to be sensitized with DNCB, reduced lymphocyte response to PHA and lymphadenopathy.

The data presented parallel the observations made in the series of asthmatic patients. They further support the hypothesis that in some patients with atopy there are

deficiencies in the immunological defence mechanisms, leading to increased antigenic stimulation of the reaginic system.

### SUMMARY

Parameters of humoral and cellular immunity were measured in 35 patients with atopic eczema. The mean serum IgE level was raised but levels of the other major immunoglobulin classes were normal. Ten percent of patients failed to respond to tetanus immunization. All patients responded to S. typhi H antigen. Fourteen percent of patients failed to mount delayed hypersensitivity reactions to a battery of three intradermal antigens. The phytohaemagglutinin-stimulated uptake of  $^3\text{H}$  thymidine by lymphocytes was normal in the presence of autologous serum or foetal calf serum. The spontaneous lymphocyte  $^3\text{H}$  thymidine uptake was normal except in patients who failed to make DHS reactions. This group had an elevated spontaneous uptake. T and B lymphocyte numbers were within the normal range.

These results are similar to those found in asthmatic patients and support the hypothesis that in some patients, atopic eczema is associated with an immunodeficiency state. There were variations in the frequencies of different abnormalities compared with asthmatics. These may be chance occurrences or related to the different clinical manifestations of atopy.

## CHAPTER V

### HELMINTHIASIS and ATOPY

Introduction	122
Location	126
Subjects and Methods	130
Results	131
Discussion	140
Summary	145

## INTRODUCTION

Immunization procedures successfully used against bacterial and viral infections have been largely unsuccessful in dealing with helminth infection in animals (Terry, 1968) and are untried in man. This has led to the systematic study in animals of the mechanisms of naturally acquired host resistance to helminth infections.

Kelly (1973) has summarized the ways in which the animal host immune response may affect parasitic helminths: retardation or inhibition of development, failure to develop a particular anatomical feature, reduction in the establishment rate of infection, suppression of worm-egg production, metabolic changes, and the "self-cure" phenomenon, i.e. the spontaneous ejection of adult worms from the intestine a short while after the primary infection is established.

In animal helminth infections both antibodies (Sinclair, 1970) and sensitized lymphoid cells (Dineen et al., 1973) are produced. The relative importance of humoral and cellular mechanisms of control is a subject of considerable controversy (Ogilvie and Jones, 1971; Kelly, 1973). Much evidence has been accumulated by animal experiments in which attempts have been made to transfer resistance passively with either serum or sensitized lymphoid cells.

Because of the number and complexity of antigens involved, the role of antibody in resistance to helminths

is difficult to elucidate (Sinclair, 1970). Although in many experiments, some resistance could be obtained by passive transfer of serum, it was not usually comparable to that obtained by active infection. Protective antibodies have been found in the IgG class (Di Conza, 1969; Jones et al., 1970), but not in the IgM (Di Conza, 1969; Ogilvie and Jones, 1971) or IgA fractions (Jones et al., 1970). Reagin-like antibodies have been found in many cases of animal helminth infections (Sinclair, 1970). It is possible to visualize a mechanism by which reaginic antibodies may be effective. In the presence of specific antigen, reagins attached to mast cells or basophils release biologically active amines, e.g. histamine and 5 hydroxytryptamine which could adversely affect intestinal helminths, resulting in their expulsion. Antihistamines have indeed been shown to inhibit the development of resistance. Moreover, the administration of the histamine precursor L-histidine, and serotonin, increased the resistance of rats to Trichostrongylus colubriformis (Rothwell et al., 1971).

Evidence has also been accrued for the importance of cell-mediated immunity. Protective immunity to T. colubriformis was produced by transfer of immune lymphoid cells in guinea pigs (Wagland and Dineen, 1965), and similarly in rats infected with Nippostrongylus brasiliensis (Ogilvie and Jones, 1968). That the lymphocytes involved are T cells has been shown by the abolition of resistance by

neonatal thymectomy, long-term lymphatic drainage, and the administration of antilymphocyte serum (Ogilvie and Jones, 1968; Dineen and Adams, 1970; Kelly, 1972).

It is probable that there is a role for both the humoral and cellular immune mechanisms in resistance to helminth infection. In humans it seemed likely that reaginic antibodies may be of importance, for raised serum IgE levels have been found in patients with a variety of helminth infestations including Ascaris lumbricoides (Johansson et al., 1968), Toxocara spp (Hogarth-Scott et al., 1969), Trichinella spiralis (Rosenberg et al., 1970), Capillaria philippinensis (Rosenberg et al., 1971), Schistosoma japonicum, Wuchereria bancrofti and hookworm (Ito et al., 1972).

Raised serum levels of IgE had initially been found in the atopic disorders (Johansson, 1967; Johansson et al., 1970). These disorders, asthma, hay fever and atopic eczema are frequent and tend to follow a genetic pattern (Coca and Cooke, 1923; Sherman, 1965).

Helminth infestations have long contributed to the ill-health of a large proportion of mankind. While the existence of high levels of IgE in human helminthiasis suggested that reaginic antibodies may have a role in resistance to worms, it seemed paradoxical that antibodies of the same class caused ill-health in sufferers from the

atopic diseases. In an attempt to reconcile these observations, the hypothesis was conceived that the genetically determined capacity to make IgE antibodies efficiently confers a survival advantage. A well-known example of such a genetically determined defence mechanism which carries both advantage and disadvantage is the interaction of sickle cell anaemia and malaria. Man's long association with worms may have influenced the genetic capacity to produce IgE antibodies.

This study was undertaken in an attempt to demonstrate, by estimation of faecal egg counts, increased resistance to hookworm infestation in an atopic population as opposed to a non-atopic population, and to study IgE and eosinophil levels in these groups.

## LOCATION

The investigation was carried out in the Goroka Sub-district of the Eastern Highlands District of Papua New Guinea (Fig. 5.1). Villagers were studied in the seven villages shown in Fig. 5.2. These villages (Fig. 5.3), at an altitude of 1700 metres, were scattered around a branch of the Asaro River on a gently sloping terrain. The average rainfall is 80" per annum, with partially defined wet and dry seasons. All of the villages were of the Gahuku linguistic group. The social structure is patrilineal and patrilocal (Read, 1965). The villages themselves are usually of 100-200 people. There was, however, frequent movement between the villages, particularly to the village of the marriage partner or to villages of the same house line.

Almost all the villagers were unshod. Although some villagers had latrines, they were used infrequently and often were in a state of disrepair. Defaecation occurred in the bush, vegetable gardens or coffee plantations.

In addition, asthmatic patients at the Goroka Base Hospital were studied. These patients came from throughout the District, but particularly from areas close to Goroka, with characteristics similar to those described above.



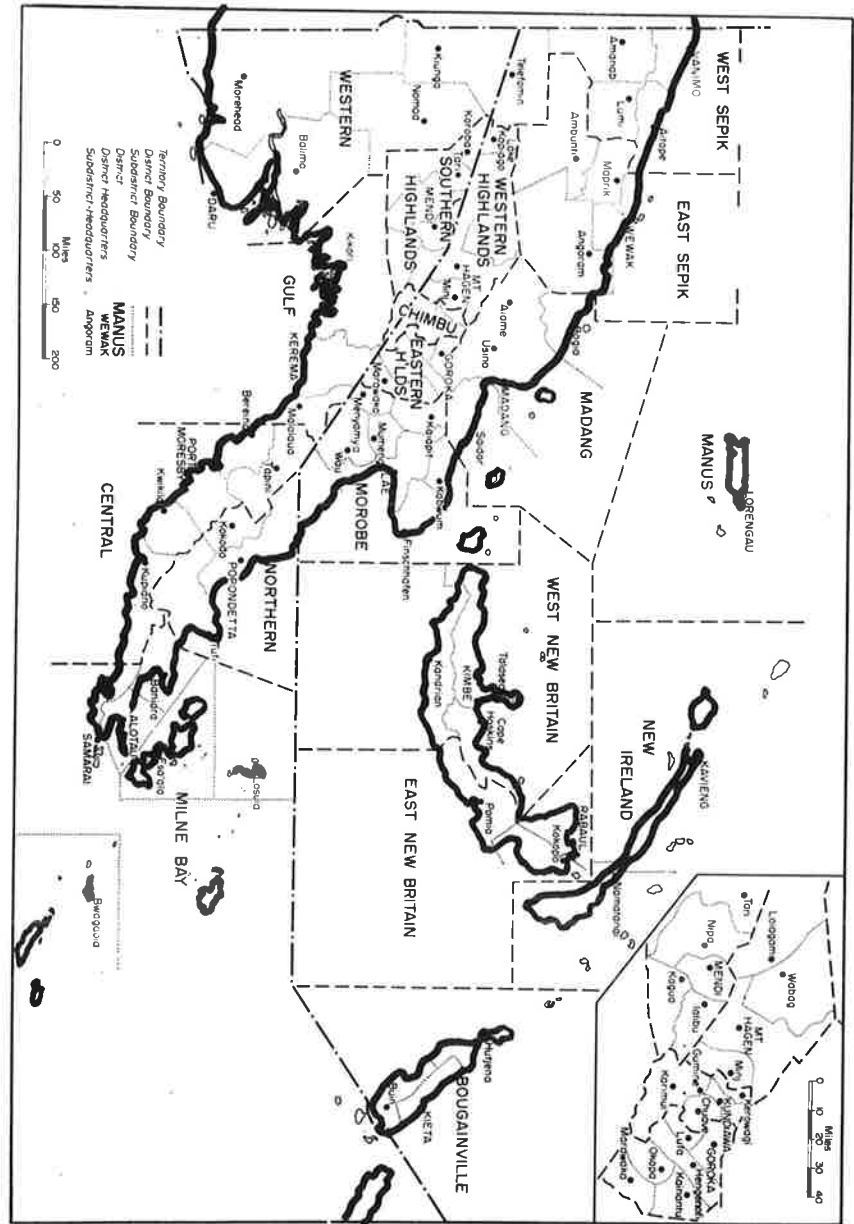

Fig. 5.1 Papua New Guinea (reproduced by permission from *New Guinea: The Territory and its People* by D.A.M. Lea and P.G. Irwin, Oxford University Press, Melbourne).

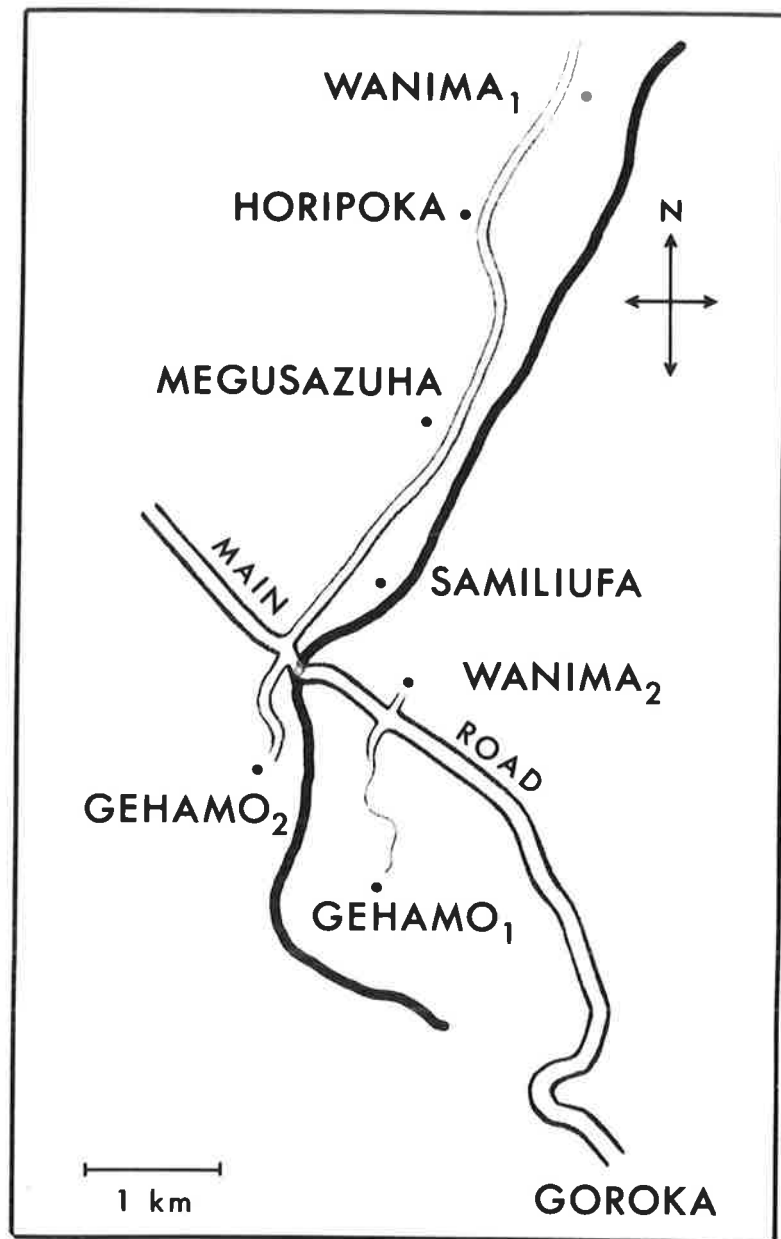

Fig. 5.2 Location of villages around the Gehamo River.



Fig. 5:3a Gehamo River and surrounds.



Fig. 5:3b Megusazuha village early in the morning.

SUBJECTS AND METHODS

Skin testing for immediate hypersensitivity was carried out by the prick method on 500 villagers using the following preparations:

Bencard, England: Dermatophagoides farinae

Candida albicans

Ascaris lumbricoides

Sudan grass

C.S.L., Australia: D. pteronyssinus

Mosquito

Alternaria

Cladosporium

Penicillium

Kangaroo grass

Pennisetum grass

Pig hair

Dog hair

Hen feathers

A subject was considered atopic if a weal of 2 mm or more was produced by at least one allergen. It was not intended that this procedure should be exhaustive, but rather that there would be a reasonable chance of identifying a large proportion of the atopic population.

Twenty eight inpatients were studied in the Goroka hospital. A clinical diagnosis of asthma was made in all

these patients. Pulmonary function tests were performed on most patients and demonstrated reversible airways obstruction.

Blood samples were taken for estimation of serum IgE and blood eosinophil levels as described in the Methods chapter. Venepuncture was always performed early in the morning. Faeces were collected and egg counts for hookworm performed as previously described (page 47).

## RESULTS

Ten percent of the 500 villagers were identified as atopic on the criterion defined above. Thirty six percent of villagers classed as atopic reacted to one allergen, while 64% were multiple reactors.

Faecal egg counts were performed in 50 non-asthmatic atopic villagers, 24 asthmatic inpatients, and 139 non-atopic villagers. Atopic and non-atopic villagers were taken in similar proportions from each of the villages. Egg counts of non-atopic subjects did not vary from village to village (Table 5.1). The age distribution of each of the three groups is shown in Table 5.2. The age of each subject could only be estimated. When egg counts of non-atopic subjects were compared for each decade, no significant differences were found.

Hookworm infestation was demonstrated in all the

subjects studied. In six samples cultured to the larval stage, only Necator americanus was identified. No other intestinal helminths were demonstrated in any of the subjects.

The egg counts were expressed as eggs/gm faeces as shown in Fig. 5.4. There was a significant reduction in egg counts in the non-asthmatic atopic population when compared with non-atopic villagers ( $P < 0.001$ , Student's "t" test). Similarly egg counts were reduced in asthmatic subjects ( $P < 0.01$ , Student's "t" test). When the fifteen skin test positive asthmatics were compared with the nine skin test negative asthmatics, the mean egg count was lower in the former group, but the difference was not statistically significant. Tests of significance were calculated using logarithmically transformed values.

Serum IgE and blood eosinophil levels were measured in asthmatics and atopic and non-atopic villagers. Atopic and non-atopic subjects were again taken in similar proportions from each of the villages. The age distribution was similar in the three groups: asthmatics,  $38 \pm 10$  years; non-asthmatic atopics,  $33 \pm 15$  years; and controls,  $39 \pm 14$  years.

Both serum IgE levels and blood eosinophil levels were substantially greater than those found in temperate zones without endemic hookworm infestation (Johansson, 1968; Dacie, 1968).

Serum IgE levels are shown in Fig. 5.5. There was significant elevation in the 51 non-asthmatic atopic subjects when compared with 93 non-atopic villagers ( $P < 0.02$ , Student's "t" test). Similarly, levels were elevated in the 28 asthmatic patients ( $P < 0.05$ , Student's "t" test). When both groups were combined and compared with non-atopic villagers, there was increased statistical significance ( $P < 0.005$ , Student's "t" test). Tests of significance were calculated using logarithmically transformed values.

Blood eosinophil levels are shown in Fig. 5.6. There was a significant elevation in the 66 asthmatics plus non-asthmatic atopics when compared with the 94 control subjects ( $P < 0.05$ , Wilcoxon's Sum of Ranks test).

A significant correlation was established between serum IgE levels and blood eosinophil levels in both non-atopic subjects ( $r = 0.3492$ ,  $n = 94$ ,  $P < 0.001$ ) and in the asthmatic plus non-asthmatic atopic group ( $r = 0.3068$ ,  $n = 66$ ,  $P < 0.05$ , Fig. 5.7).

No correlation was established between IgE levels and hookworm egg counts in either control subjects ( $r = 0.0879$ ,  $n = 71$ , N.S.), atopics ( $r = 0.2602$ ,  $n = 49$ , N.S.) or asthmatic subjects ( $r = 0.0029$ ,  $n = 24$ , N.S.).

Similarly, no correlation was established between absolute eosinophil counts and hookworm egg counts in either control subjects ( $r = 0.0370$ ,  $n = 46$ , N.S.) or asthmatics plus atopics ( $r = 0.1501$ ,  $n = 64$ , N.S.).

Table 5.1

VILLAGE HOOKWORM EGG COUNTS\*

Village	Number of Subjects	Geometric Mean	Range
Gehamo <sub>1</sub>	25	3,000	300 - 37,000
Gehamo <sub>2</sub>	27	3,900	430 - 36,000
Wanima <sub>2</sub>	17	2,500	170 - 36,000
Samiliufa	27	3,300	240 - 39,000
Megusazuha	22	2,200	170 - 28,000
Wanima <sub>1</sub>	15	2,000	70 - 55,000
Horipoka	6	2,700	340 - 22,000

\* eggs per gramme faeces

No significant differences between any of the villages (Student's "t" test using logarithmically transformed values).



Table 5.2

AGE DISTRIBUTIONPercentage of Subjects in Each Decade

	0-9	10-19	20-29	30-39	40-49	50-59	60-69
Asthmatics (24)	-	-	18	41	16	21	4
Non-asthmatic atopics (50)	12	4	22	34	14	8	6
Non-atopics (139)	12	9	14	22	17	20	6

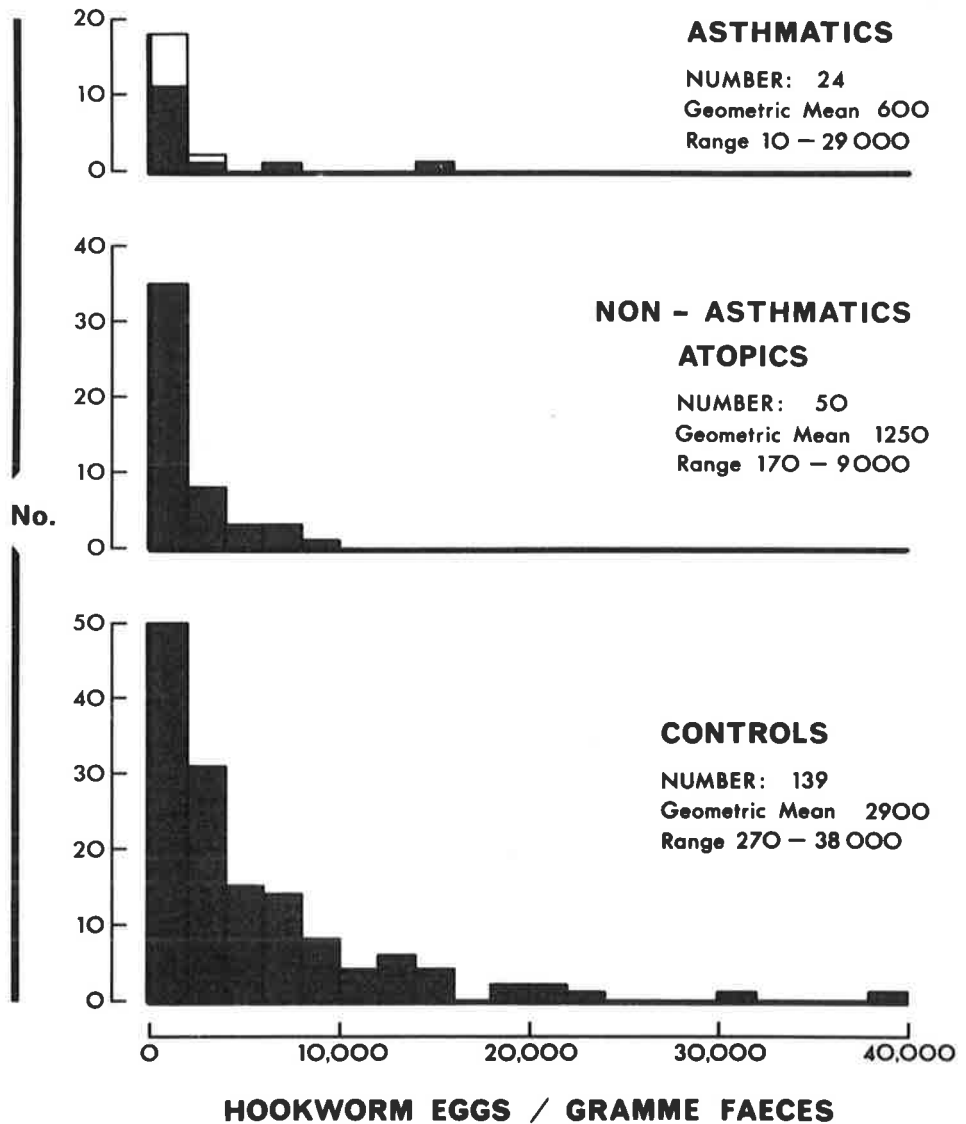

Fig. 5.4 Distribution of faecal hookworm egg counts in asthmatics, non-asthmatics atopics and normal subjects. For asthmatics, solid histograms represent skin test positive, and unshaded histograms represent skin test negative patients.

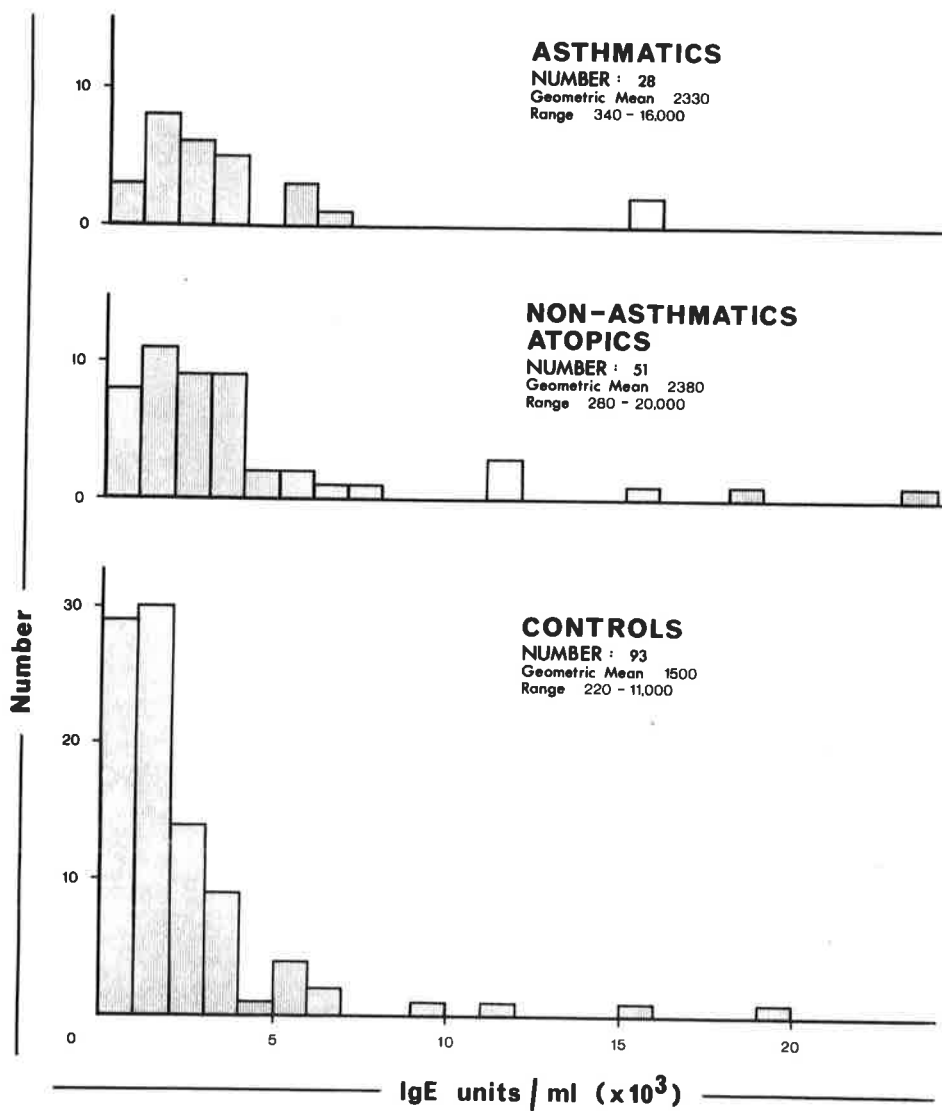

Fig. 5.5 Serum IgE levels in asthmatics, non-asthmatic atopics and normal subjects.

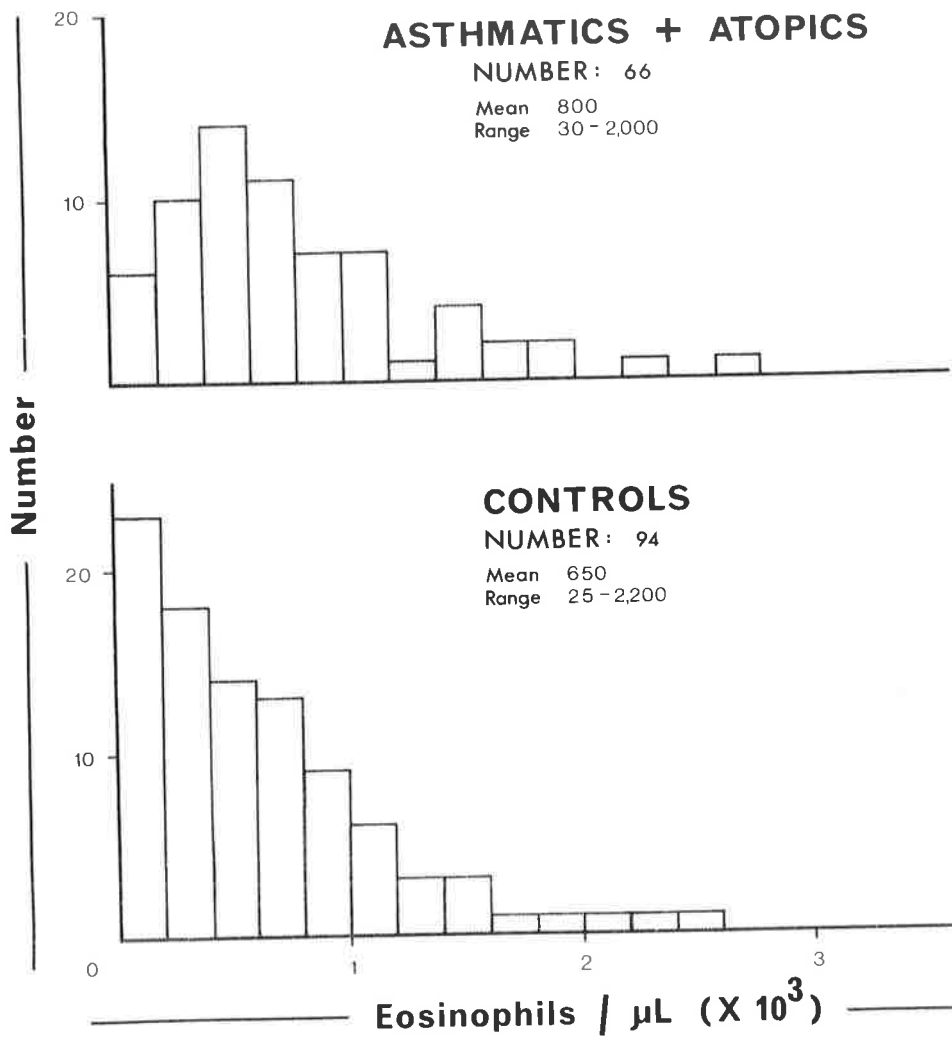

Fig. 5.6 Blood eosinophil counts in asthmatics plus non-asthmatic atopics and normal subjects.

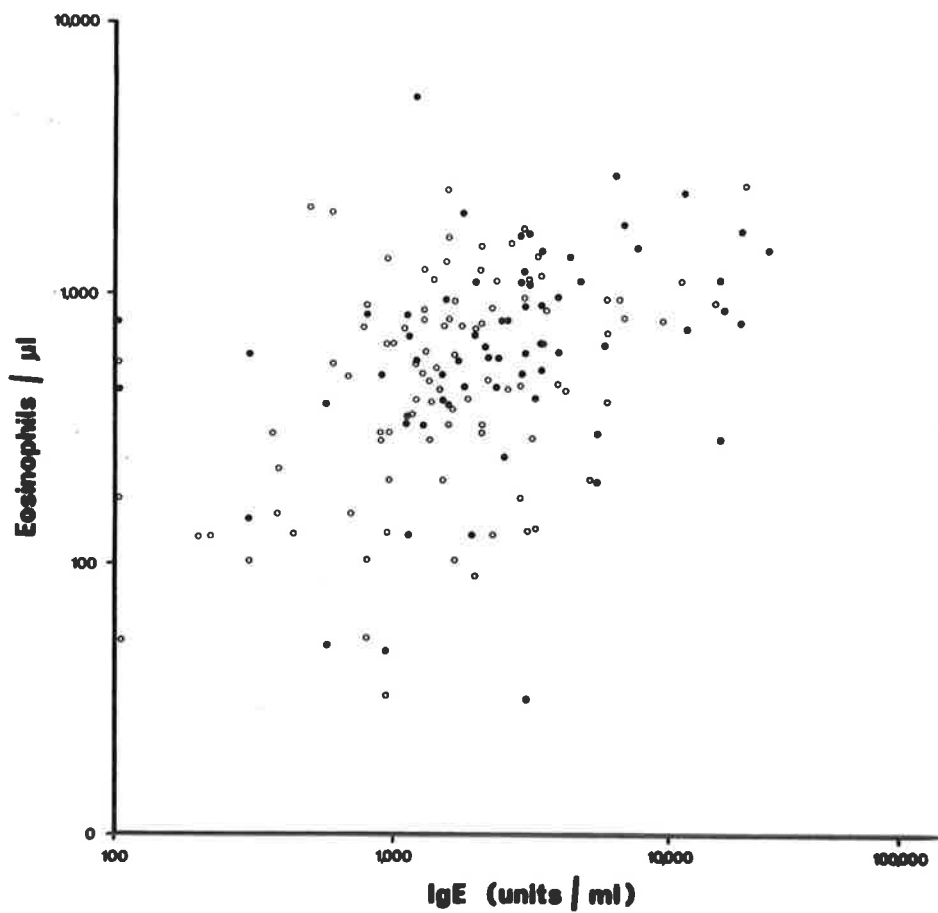

Fig. 5.7 Correlation between serum IgE and blood eosinophil counts.

• represents normal subjects. o represents asthmatic and non-asthmatic atopic subjects.

## DISCUSSION

Considerable controversy exists over the relative importance of humoral versus cellular immune responses in controlling helminth infestation in animals (Ogilvie and Jones, 1971; Kelly, 1973). The relationship between reaginic antibodies and protective immunity to helminth infestation in animals is not clear (Sinclair, 1970; Kelly, 1973), although their constant association with helminth infestation would suggest some functional role. Similarly, the role of IgE in human helminthiasis is still obscure (Somei et al., 1972) despite a constant association between raised serum levels of IgE and a variety of helminth infestations.

This study shows an inverse relation between atopy and hookworm egg counts. In contrast, a positive correlation between asthma and the intestinal parasites, Ascaris lumbricoides, Necator americanus and Strongyloides stercoralis had been claimed (Tullis, 1970), although this was not confirmed in subsequent studies (Van Dellen and Thompson, 1971; Cheah and Kan, 1972). These latter studies only compared the presence with absence of helminth infestation. In the part of the Eastern Highlands District of Papua New Guinea in which this study was carried out however, hookworm infestation was universal. A more precise quantitation of infestation was determined by egg counting. Intestinal worm burdens have been correlated with faecal egg counts

(Wilcocks and Manson-Bahr, 1972). In the case of Necator americanus, 44 eggs per gramme of faeces are reckoned to represent one female worm. The interpretation of the results has been facilitated by the absence of other intestinal helminthiasis in the area under study. The observations on the non-asthmatic atopic population were controlled by taking normal subjects from the same villages in similar proportion and with a similar age distribution. Furthermore, no significant differences in egg counts were found between the villages, or between different age groups. The asthmatic population, on the other hand, was less well controlled, since these were hospital patients who came from all over the district. Nevertheless, the results in this group are similar to those found in the non-asthmatic atopic group.

This study provides evidence that the atopic population, which is presumably more adept at producing IgE antibodies, has a reduced egg output. This has beneficial implications for the community, with restricted hookworm transmission. The reduced egg output may reflect suppression of worm-egg production, or reduction in the establishment rate of infection (Kelly, 1973). It has been observed in relation to canine hookworm disease, that immunity, whether induced by vaccination, or naturally, does not usually result in complete destruction of the larvae or complete elimination of the intestinal burden of subsequent challenge infections,

but protects the host against the establishment of the majority of the challenge larvae, and thus against clinical hookworm disease (Miller, 1971). It is therefore possible that the observed reduced egg counts represent a reduced burden of adult worms, with beneficial implications for the individual.

Although blood levels do not necessarily reflect tissue activity, the raised serum IgE levels may represent increased immediate hypersensitivity reactions in the tissues. Helminth infestation in animals, in addition to inducing a reaginic response to helminth antigens, potentiates reaginic antibody response to non-helminth antigens (Orr and Blair, 1969, Jarrett and Stewart, 1972). The relatively higher IgE levels in the non-asthmatic atopic and asthmatic groups may represent increased titres of antibody to non-helminth antigens, hookworm-specific antigens, or both. The non-asthmatic atopic and asthmatic populations presumably respond in greater degree to non-helminth antigens as in other parts of the world. The raised IgE levels in these groups may thus simply represent the addition of helminth antibodies to an already high IgE level. Alternatively, the raised IgE levels may result from higher titres of hookworm-specific antibodies as a manifestation of increased reaginic responsiveness to any antigen. Even so, this may have no functional significance. When taken in conjunction with reduced hookworm egg output in these groups however,



the higher IgE levels are consistent with the hypothesis that atopic individuals are more successful in controlling helminth infestation by virtue of an increased efficiency in IgE responsiveness to helminth antigens.

Speculation continues as to the role of the eosinophil (Lancet, 1971). It has been shown that eosinophils phagocytose antigen-antibody complexes (Sabesin, 1963). Biologically active amines are chemotactic to eosinophils (Archer, 1963). The eosinophil response to histamine may be less in non-atopic people than atopic individuals (Feinberg et al., 1967). It has been stated that eosinophilia and antiparasite immune reactions are separable phenomena (Lancet, 1971). There is however, a correlation between eosinophilia and IgE levels in both normal and atopic-asthmatic groups. Furthermore, the relatively higher IgE levels in the asthmatic and non-asthmatic groups are paralleled by a relatively greater eosinophilia in these groups. The eosinophilia could be a direct response to antigenic stimulus or may be a second order phenomenon, such as a consequence of the presence of free amines, antigen-antibody complexes, or release of lymphokines.

A multiplicity of factors may be operating to produce the lack of correlation between hookworm egg counts and serum IgE or blood eosinophil levels.

It has been suggested that host resistance to helminths

is bi-phasic (Kelly, 1973). Firstly, there is immunologically specific interaction of antigen with either humoral antibody or sensitized lymphoid cells. This is followed by a non-specific phase in which mast cells and basophils are associated with release of biologically active amines, e.g. histamine, 5 hydroxytryptamine and/or lymphocytic release of lymphokines which render the environment unsuitable for the parasite. The increased resistance observed in atopics could be due to heightened ability to produce IgE antibodies specifically active against helminth antigens leading to increased release of amines. Alternatively, there may be increased sensitivity of the mast cells to released lymphokines or to a mast cell degranulating substance released from damaged parasites (Uvnas and Wold, 1967).

These results are consistent with the hypothesis that a function of the IgE-mediated immune system is to assist in control of helminth infestation, but carrying with it a propensity to atopic disease. The price of a greater ability to deal with helminth infestations may be a legacy of atopic disease.

SUMMARY

Measurements of faecal egg counts, serum IgE and blood eosinophil levels were carried out in the Eastern Highlands District of Papua New Guinea, an area of universal hookworm infestation. Subjects were divided into asthmatic, non-asthmatic atopic, and normal groups on the basis of clinical features and immediate hypersensitivity reactions to prick testing with a range of allergens. Serum IgE and blood eosinophil levels were elevated in all groups as compared with values found in temperate zones. Faecal egg counts were lower and IgE and eosinophil levels higher in the asthmatic and non-asthmatic atopic groups compared with the normal group.

These findings are consistent with the hypothesis that a function of the IgE immune system is to protect against helminth infestation.

GENERAL DISCUSSION ON CHAPTERS II-V

The data presented in the preceding chapters approach the problem of atopy in two different ways. Two fundamental questions stand out in a consideration of atopy. The first is "Why do animals have the capacity to make reaginic antibodies - what is the physiological role of immunoglobulin E"? The second is "Why is clinical disease associated with reaginic activity manifested in some individuals"? Attempts to answer these questions have been facilitated by the identification of reaginic activity in the IgE fraction of human serum and the development of methods of measuring this and other parameters of humoral and cellular immunity in recent years.

There is little doubt that reaginic antibody activity can be found in a wide range of animal species, including monkeys, dogs, rabbits, rats, mice, guinea pigs and sheep (reviewed by Stanworth, 1973). Moreover, although in most cases reaginic antibodies have not yet been isolated in pure form, those characteristics which have been studied show marked similarities to human IgE; indeed some antigenic determinants are shared between species (Stanworth, 1973). This widespread appearance of reaginic antibodies throughout the mammalian order, in itself, suggests that these antibodies have some functional role.

This view is supported by consideration of two aspects of human atopy. The first is the widespread occurrence of asthma, hay fever, atopic eczema and other isolated immediate

hypersensitivity reactions such as reactions to insect stings, drugs and foodstuffs. Asthma alone has been estimated to occur in between one and 12% of children (reviewed by Williams and McNicol, 1969), and furthermore, asthma begins after childhood in approximately half of all asthmatics (Ford, 1969). The second is the familial clustering of atopic diseases, suggesting that an atopic tendency is inherited (Sherman, 1965). Since the atopic disorders are associated with morbidity and mortality, it might be expected that the gene frequency would fall. The observed high frequency however, suggests that other factors may be at work. The capacity to produce reaginic antibodies efficiently may carry with it counterbalancing advantages.

The observation that raised serum levels of IgE were found not only in atopic individuals, but also in people suffering from helminth infestation gave a clue to a possible role for IgE. Helminth infestations have been an important cause of morbidity and mortality throughout evolution. If IgE is a factor in protection against worms, then such a pressure would favour development of a genetic pool which allowed increased efficiency in the ability to produce reaginic antibodies. A balance would be struck between the protection given against helminthiasis and the deleterious effects of clinical atopic disease. Supporting this concept was the evidence, reviewed earlier, that reagins may be important in protecting animals against helminth infestation.

Moreover, IgE-bearing plasma cells are predominantly found at the mucosal surfaces and their draining lymph nodes (Tada and Ishizaka, 1970), suggesting that the physiological action of IgE may be located at the mucosal surfaces. Many worms are in fact found at such situations. Hookworms for example, are in intimate contact with the respiratory mucosa during the larval stage and the gastro-intestinal mucosa during adult life.

It appeared that a practicable test of this hypothesis would be to measure hookworm egg counts in an appropriate population of asthmatic, non-asthmatic atopic and non-atopic individuals. If such an hypothesis were true, there should be an overall reduction in hookworm loads in the atopic segment of the population. Hookworm infestation was chosen because an area of endemic hookworm infestation was available for study, and because of the important consequences such infestation has on health. It was fortunate for the interpretation of results that hookworm infestation was universal and there was no other significant helminthiasis in the area under study.

The data presented support the hypothesis that atopy confers increased ability to deal with helminth infestation. Hookworm egg counts were reduced in the asthmatic and non-asthmatic atopic populations compared with the non-atopic population. Whether this represents the production of less eggs per worm, or the presence of less adult worms, the

benefits to the population are apparent. Pari passu with a reduction in hookworm egg counts is an elevation of serum IgE and blood eosinophil levels in the atopic populations. The atopic population therefore has an increased ability to produce IgE antibodies. It would be of value to know whether these increased total serum IgE levels represent increased titres of hookworm-specific IgE antibodies. The results available are nevertheless consistent with the concept that the atopic population is producing more specific hookworm-specific antibodies. Even so, this would not in itself prove a functional role, as it may simply represent an increased response to any antigenic stimulus, but the association with low hookworm egg counts lend weight to the hypothesis.

An interesting side-issue is the observation that almost all Papua New Guineans studied had detectable serum IgE levels. The vast majority of patients had levels above the normal range for the normal Australian population. It is apparent that there is something about a worm that turns on IgE production. This probably represents not only antibodies specific to helminthic antigens, but also antibodies against non-helminth antigens if results in the animal model also apply to humans (Orr and Blair, 1969). Search for such a trigger or triggers to IgE production may well be rewarding. If such a trigger could be found, it might also be possible to find a substance which could block the



stimulus to IgE production. This would have important implications for the therapy of asthma and the other atopic disorders.

Evidence is also presented concerning the second question as to why certain individuals develop clinical manifestations of atopy. Clinical disease seems to be associated with an increased propensity to produce reagins, as evidenced by increased serum levels of IgE. Possible explanations for the development of the atopic state have been discussed in Chapter II. It was pointed out that these hypotheses are not necessarily mutually exclusive; indeed it is likely that the atopic state is multifactorial in origin. The evidence presented in this thesis is germane to only two of these considerations.

Indirect evidence is given in support of the role of inheritance in the development of atopy. The inter-relationship between atopy and helminthiasis is consistent with a genetic polymorphism. It may be analagous to the more clear-cut instance of the effects of malaria and sickle cell anaemia on the gene pool. It provides one explanation for the high frequency of atopic genes. Subjects with the greatest genetic endowment may be those most likely to develop clinical manifestations.

Evidence is presented to support the hypothesis that immune deficiency is important in the development of the atopic state in some people. Defects of humoral immunity

have been shown in some atopics and defects of cellular immunity in others. Immune deficiency has been most markedly shown in relation to two parameters. Impairment of cellular immunity has been demonstrated by the inability of some patients to mount delayed hypersensitivity reactions on challenge with intradermal antigen. Moreover, three of four such patients could not be sensitized to dinitrochlorobenzene. Other patients have shown an impaired ability to produce antibodies to tetanus toxoid, while maintaining a normal response to S. typhi H antigen. It is possible that this may represent the relative thymus-dependence of haemagglutinating antibodies against tetanus toxoid. This group of tetanus non-responders was also immunologically abnormal in other ways, as evidenced by a high IgA level, depressed spontaneous lymphocyte  $^3\text{H}$  thymidine uptake and, impaired lymphocyte PHA responsiveness when cultured in foetal calf serum, compared with those asthmatics who did respond to immunization.

Not only were these abnormalities demonstrated in asthmatics, but also in atopic eczema patients. There were variations in the frequencies of these abnormalities. In addition, some abnormalities were found in asthmatics but not in patients with atopic eczema. Whether these were chance variations or related to the differing clinical manifestations is difficult to say.

The significance of some abnormalities were obscure,

for example the depressed phytohaemagglutinin-stimulated activity of lymphocytes of asthmatics when cultured in foetal calf serum.

It is suggested that immune deficiency is important in some patients. It is envisaged that impaired responses to antigen by the humoral or cellular immune systems result in increased antigenic stimulation of the IgE antibody system. Subsequent antigenic exposure stimulates the primed mast cells leading to clinical disorder.

It is not claimed that immune deficiency is important in all sufferers from atopic disease, but that it may be a factor in some of them. The development and application of more sophisticated techniques to assess immune function may demonstrate other evidences of immune deficiency in larger numbers of patients.

It is proposed that a function of the IgE-mediated immune system is to assist in the control of helminth infestation but carries with it a propensity to atopic disease. The price of a greater ability to deal with helminth infestation, in association with other factors such as immune deficiency, perhaps independently determined, may be a legacy of atopic disease.

## CHAPTER VI

### SERUM IgE LEVELS AFTER TREATMENT FOR HOOKWORM

Introduction	153
Subjects and Methods	153
Results	154
Discussion	159
Summary	161

## INTRODUCTION

As described in the introduction to Chapter V, raised serum levels of IgE have been found in a variety of helminth infestations. Biroum-Noerjasin (1973) reported increased serum IgE levels after treatment for hookworm in a Javanese population. This is in contrast to the fall which occurred after treatment in patients with intestinal capillariasis (Rosenberg et al., 1970), and six months after an acute episode of trichinosis (Rosenberg et al., 1971).

This study was undertaken to determine whether the findings of Biroum-Noerjasin could be repeated.

## SUBJECTS AND METHODS

Subjects studied were villagers from Megusazuha, Samiliufa and Gehamo number 2 villages (Fig. 5.2). Faeces for hookworm egg-counting and blood for serum IgE and absolute eosinophil counts were collected in 53 subjects as described previously. Each subject was then given a single 900 mg dose of Pyrantel Embonate ("Combantrin", G.P. Laboratories). Blood samples were collected six weeks later in all subjects and faecal specimens in 27 subjects. Another five subjects were given Pyrantel Embonate 600 mg weekly for six weeks, and blood and faecal specimens collected fortnightly for 12 weeks. Control subjects were given Vitamin C 25 mg.

## RESULTS

Hookworm ova were detected in samples from all subjects. Twenty one percent had egg counts of less than 1,000, 43% between 1,000 and 5,000, 21% between 5,000 and 10,000 and 15% more than 10,000 eggs per gramme. Six weeks after anthelmintic treatment, ova were not detectable in 44% of patients, there was at least a tenfold fall in concentration in 7%, a five to ninefold fall in 19%, a two to fourfold fall in 19%, and no change in 11%. In the five patients receiving anthelmintic treatment weekly for six weeks, ova were not detectable from the fourth week onwards.

Serum IgE levels were measured before and six weeks after single dose anthelmintic treatment in 46 sample pairs (Fig. 6.1). The geometric mean IgE level fell from 2,310 to 1,860 units per ml. This fall was highly significant ( $P < 0.001$ , paired "t" test). Serum IgE levels were measured before and after a six week interval in twenty subjects who did not receive anthelmintic therapy. No significant change occurred, the geometric mean IgE values being 2,250 and 2,420 units per ml respectively.

Serum was taken fortnightly from five subjects who received weekly anthelmintic treatment in the first six weeks, and from two control subjects (Fig. 6.2). A consistent decline in IgE levels over three months was seen in four subjects. The fifth showed an initial sharp fall, a

rise at six weeks, then a slow decline. The two patients who did not receive specific therapy showed little change in IgE levels.

Blood eosinophil levels were measured in 53 sample pairs before and six weeks after single dose anthelmintic treatment (Fig. 6.3). The mean level fell from 745 to 400 eosinophils per  $\mu$ l. This fall was highly significant ( $P < 0.001$ , paired "t" test).

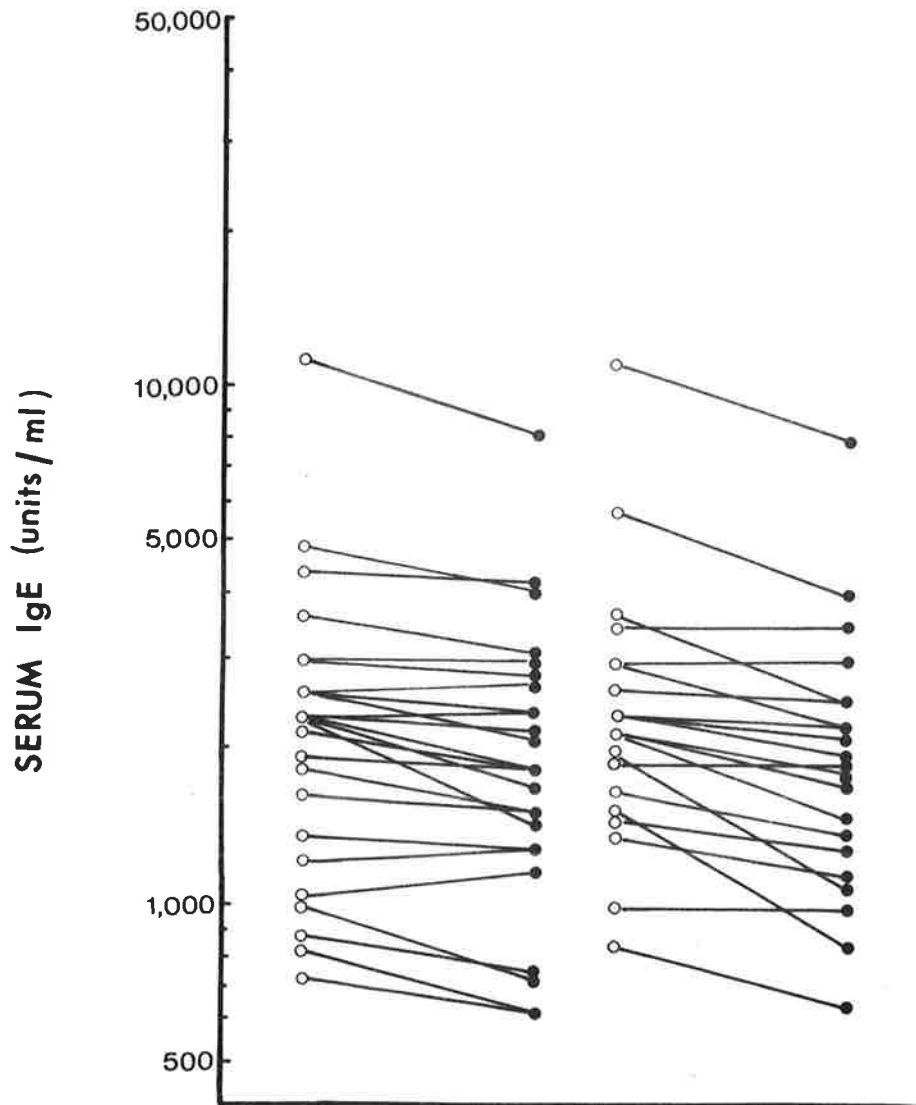

Fig. 6.1 Serum IgE levels before and six weeks after anthelmintic treatment in 46 subjects. o represents pre-treatment and • post-treatment levels.



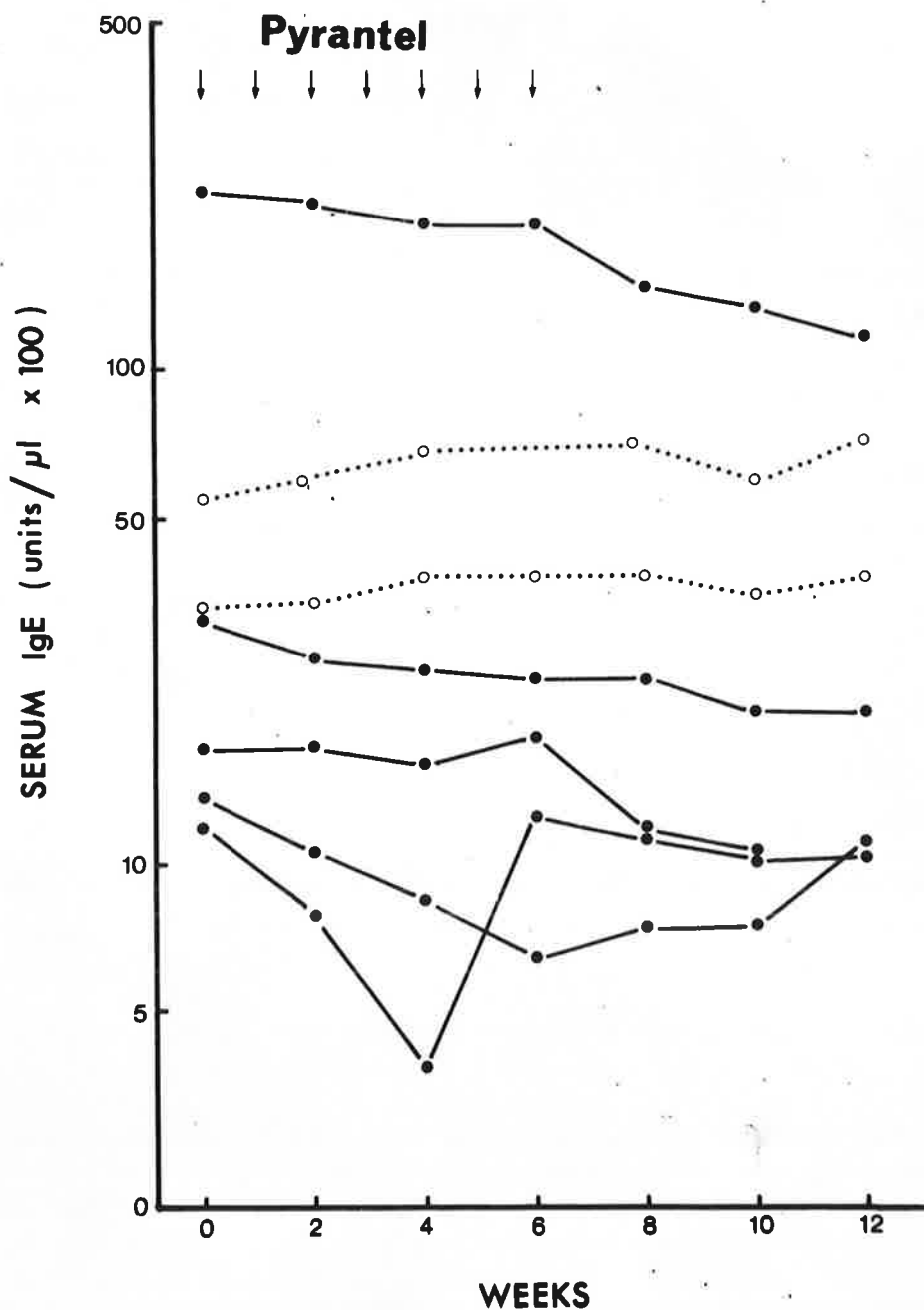

Fig. 6.2

Serum IgE levels measured fortnightly. —●—●— represents subjects receiving anthelmintic treatment for six weeks. ○·····○ represents subjects not receiving specific therapy.

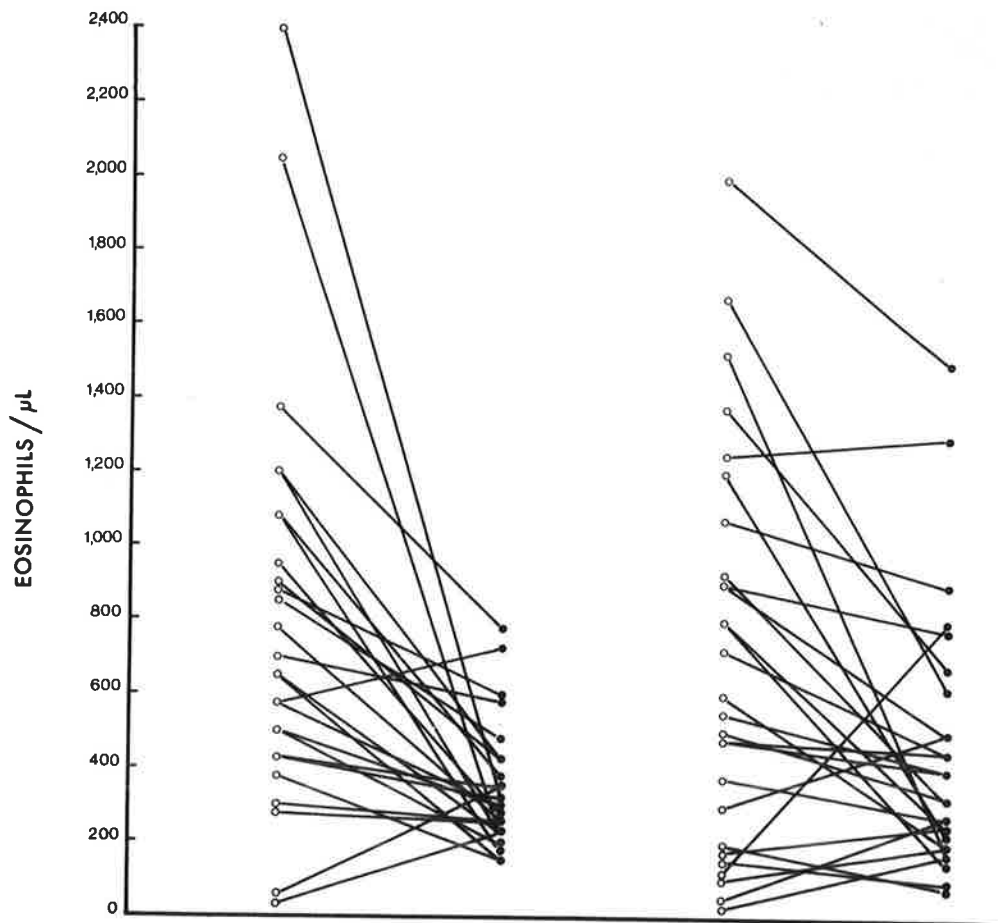

Fig. 6.3 Blood eosinophil levels before and six weeks after anthelmintic treatment in 53 subjects. o represents pre-treatment and • post-treatment levels.

## DISCUSSION

High serum IgE levels were found in an area of universal hookworm infestation. Anthelmintic treatment resulted in elimination of, or reduction in, worm burdens in most persons. This was associated with a fall in IgE levels six weeks after treatment.

Serial investigation over three months supports the view that IgE levels fall after anthelmintic therapy. The level fell steadily in four patients. The rise noted in one patient, with no ova detectable in the stools, may reflect the larval stage of re-infection, as it has been shown that both the systemic larval phase and the gastro-intestinal adult phase stimulate IgE production in rats infected with Nippostrongylus brasiliensis (Jarrett and Stewart, 1973).

The fall in IgE levels parallels that seen after treatment of intestinal capillariasis, and after the acute phase of trichinosis. The fall may reflect a decrease in antigenic stimulus by elimination or reduction of the worm burden. It has been shown in animals that helminth infestation potentiates reaginic antibody responses to non-helminth antigens (Orr and Blair, 1969). Jarrett and Stewart (1973) have suggested that such responses may require maintenance by live worms over a period of time. The fall in IgE levels could also represent lower titres of non-helminth reaginic antibodies following removal of the worms.

Blood eosinophil levels also fell six weeks after anthelmintic treatment. This also is consistent with a lessened stimulus to eosinophilia after elimination or reduction of the worm burden.

These findings contrast with those reported by Biroum-Noerjasin (1973) in a Javanese population in which a rise in IgE levels after anthelmintic treatment was claimed. Several possibilities exist for this discrepancy. In that study, samples were taken before and after treatment in only eight individuals, whereas in this study there were 46 subject pairs. Other results reported do not represent a comparison with in the same group, but are from different individuals at varying periods after anthelmintic treatment. It is doubtful whether it is valid to compare such groups. Furthermore, ova were absent in only 17% of Javanese subjects compared with 44% of our subjects six weeks after treatment. It is possible that in the Javanese study, either insufficient dose of anthelmintic was used, or some patients did not take the drugs given.

The finding of a fall in IgE levels after anthelmintic treatment is satisfying in that it accords with the general observation in other immunoglobulin classes that antibody levels fall after removal of the antigenic stimulus.

SUMMARY

Serum IgE levels were high in a Papua New Guinea population infested with hookworm. In contrast to another report, serum IgE and blood eosinophil levels fell after treatment with anthelmintics.

## CHAPTER VII

### IgE and IgD in MISCELLANEOUS CONDITIONS

Introduction	162
Liver Disease	162
Coeliac Disease	163
Paraproteinaemia	163
Lymphoma	164
Sjogren's Syndrome	165
Aplastic Anaemia	165
Antinuclear Factor	166
IgD in Papua New Guineans and Australians	169
IgD, Helminthiasis and Atopy	172

## INTRODUCTION

Serum IgE levels were measured in a variety of conditions according to the availability of sera. In more than half of the sera, IgE levels were less than 100 units per ml and could not be measured by the radioactive single radial immunodiffusion technique. Accordingly, results have been expressed in histogram form for visual interpretation. A single tailed range has been presented as all values up to the ninety fifth percentile.

## LIVER DISEASE

Heiner and Rose (1970) reported that nine of 18 subjects with Laennec's cirrhosis had serum IgE levels above 800 ng/ml. Brown et al (1973) found no elevation of IgE levels in ten patients with chronic liver disease.

Serum IgE levels were measured in sixty one patients with liver disease (Fig. 7.1). In 39, a diagnosis of viral hepatitis had been made. Fourteen were suffering from chronic alcoholic liver disease and eight had miscellaneous conditions including chronic active hepatitis, primary biliary cirrhosis and obstructive jaundice.

There was no evidence for increased serum IgE levels in patients with viral hepatitis. Although the numbers were small, results were suggestive of an elevation in some patients with chronic alcoholic liver disease, consistent

with the observations of Heiner and Rose.

### COELIAC DISEASE

Serum IgE levels were measured in 36 patients with coeliac disease (Fig. 7.1). The sera were provided by Dr. R.N. Ratnaike. IgE values did not differ markedly from normal controls. Only one patient had a level of more than 800 units/ml compared with five of 16 patients reported by Heiner and Rose (1970). These findings are similar to those of Brown et al (1972) who found normal IgE levels in all of nine coeliac patients.

These observations are consistent with the comment of Hobbs et al (1969) that coeliac disease is unlikely to be mediated through reaginic hypersensitivity.

### PARAPROTEINAEMIA

IgG myeloma is frequently associated with reduced serum levels of IgA and IgM. Similarly IgA and IgM paraproteinaemias are associated with depression of the other two major immunoglobulin classes (Hobbs, 1967). Measurements of IgD and IgE were made to see if this phenomenon extended to these two classes.

Serum IgD levels were measured in twenty patients with a variety of myelomas and twenty age and sex matched controls. Patients had a geometric mean IgD level of 3.7



units per ml with a standard deviation of 9 units per ml compared with  $12 \pm 60$  units per ml for the controls. This difference was significant ( $P < 0.02$ , Student's "t" test). The low serum IgD levels are consistent with the observation seen in the other major immunoglobulin classes.

Serum IgE levels were measured in the same twenty patients. One patient had a serum IgE level above the normal range (Fig. 7.2). Although the numbers are small, the findings are suggestive that there may not be a uniform depression of IgE levels in myeloma. This accords with the observations of Heiner and Rose (1970) who found that four of 14 patients with multiple myeloma without an "M" peak had raised IgE levels.

### LYMPHOMA

Cellular immunity is frequently impaired in patients with lymphoma (Harrison, 1970). Approximately 20% of patients with Hodgkin's Disease have an eosinophilia (Harrison, 1970).

Serum IgE levels were determined in 26 patients with lymphoma, mostly Hodgkin's Disease. Five patients had values above the normal range (Fig. 7.2).

The mechanism of elevation of IgE levels in a proportion of patients with lymphoma may be similar to that postulated in some cases of asthma, namely that impaired cellular

immunity leads to increased stimulation of the reaginic system. As discussed earlier, the eosinophilia which is often seen in Hodgkin's Disease may be a concurrent epiphenomenon or a sequential result of increased reaginic activity.

#### SJOGREN'S SYNDROME

Serum IgE levels were measured in six patients (Fig. 7.2). Two patients had IgE levels above the normal range. Although the numbers are far too small for meaningful comment, the results suggest that further investigation of larger numbers of patients may be informative, particularly as Sjogren's Syndrome may be complicated by the development of lymphoma (Anderson and Talal, 1972).

#### APLASTIC ANAEMIA

The association of aplastic anaemia and drug therapy, apparently idiosyncratic in origin, is well known (Harrison, 1970). It therefore was of interest to determine whether serum IgE levels were elevated in some cases of aplastic anaemia as some drug hypersensitivity reactions are mediated by reaginic antibodies (Humphrey and White, 1970).

Serum IgE levels were measured in eleven patients with aplastic anaemia. No patient had an elevated IgE level (Fig. 7.2).

## ANTINUCLEAR FACTOR

Antinuclear factor is commonly found in the serum of patients with auto-immune diseases (Humphrey and White, 1970). Serum IgE levels were measured to determine whether there was also an abnormality of the reaginic system in 40 patients with strongly positive antinuclear factor in the serum. Fifteen patients had systemic lupus erythematosus, five systemic sclerosis, four rheumatoid arthritis, two dermatomyositis and fourteen had miscellaneous or undiagnosed conditions.

Only three patients had IgE values above the normal range (Fig. 7.2).

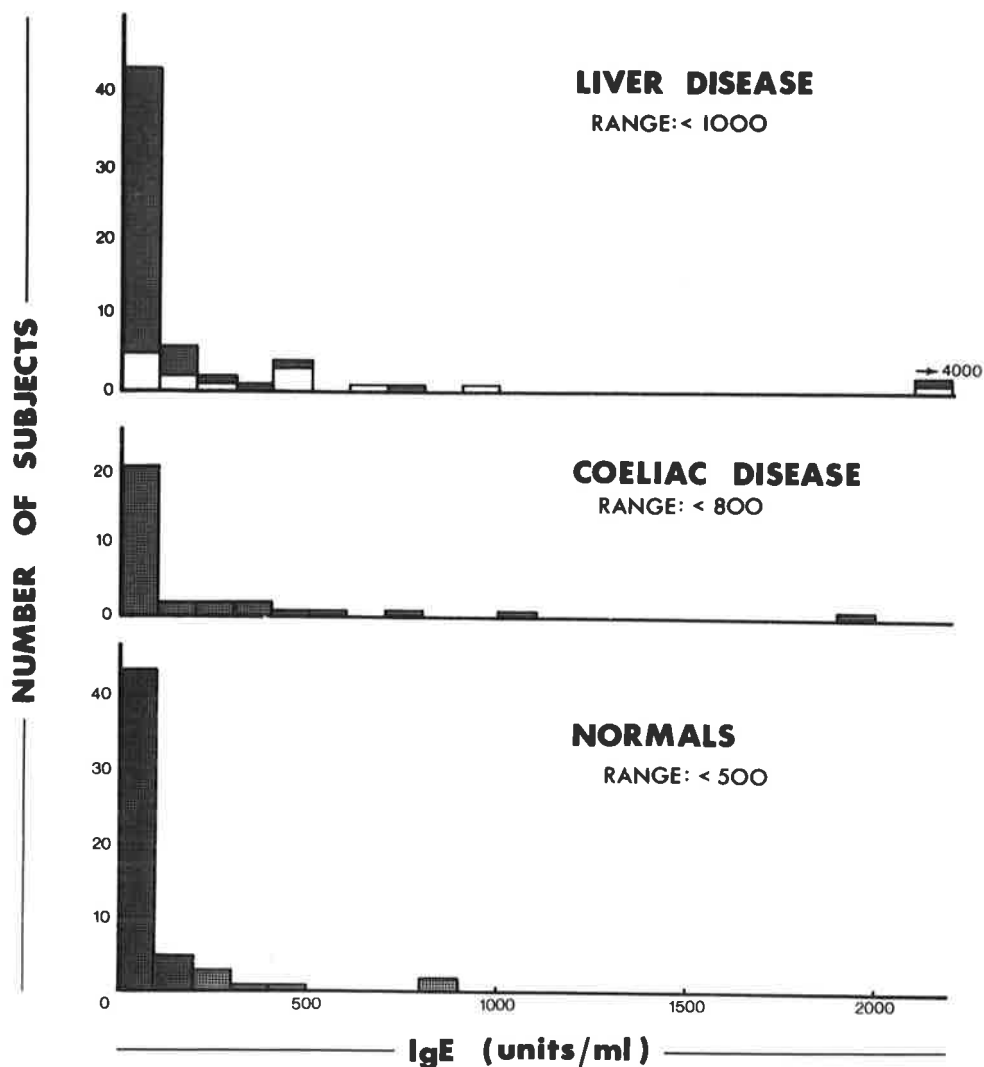

Fig. 7.1

Serum IgE levels in normal subjects and patients with chronic liver disease and coeliac disease. In the histogram on liver disease, the unhatched segments represent patients with alcoholic liver disease and the hatched segments represent patients with other forms of chronic liver disease.

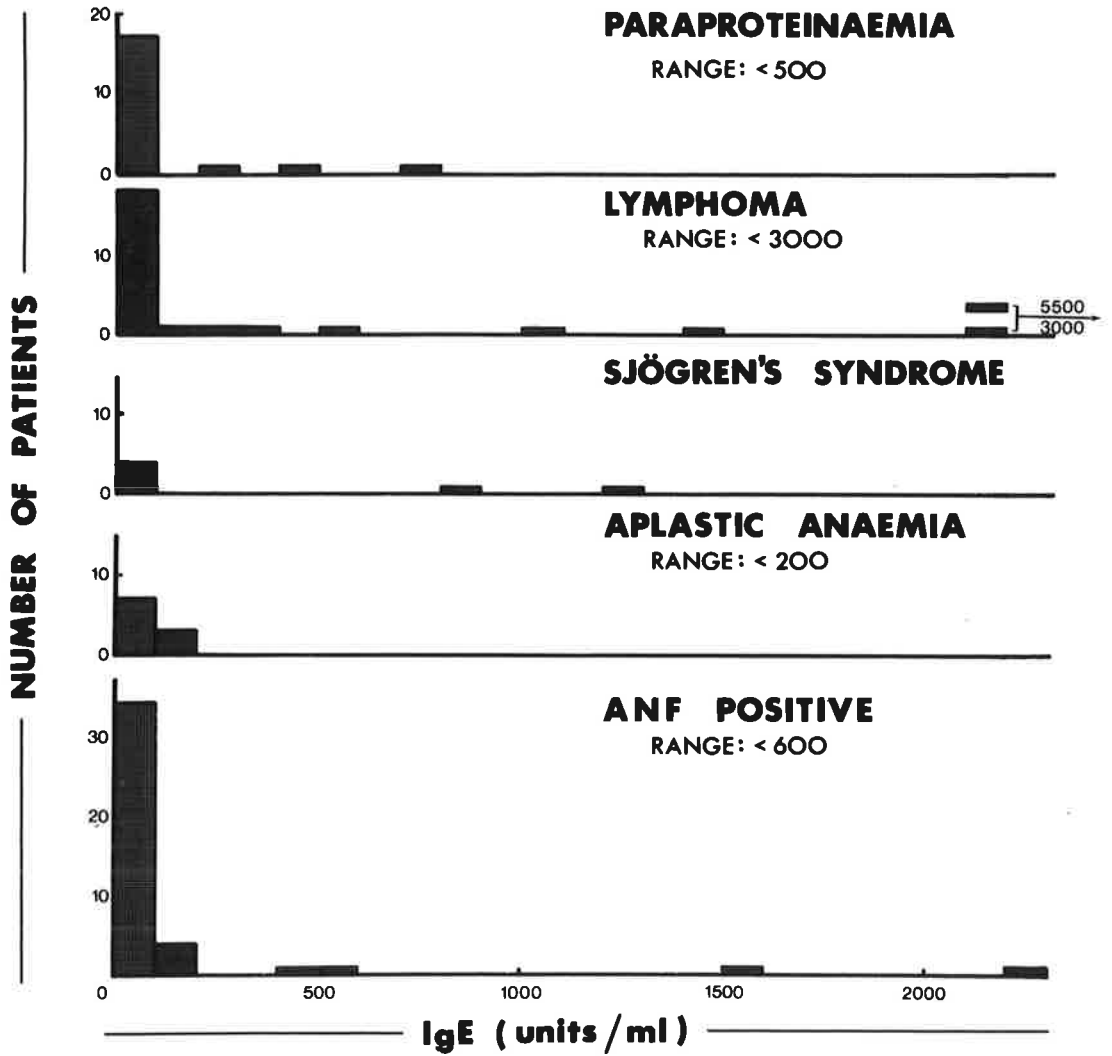

Fig. 7.2 Serum IgE levels in patients with a paraproteinaemia, lymphoma, Sjogren's Syndrome, Aplastic Anaemia or a group of patients with a positive antinuclear factor in the serum.

SERUM IgD IN PAPUA NEW GUINEANS AND AUSTRALIANS

Immunoglobulin D was first described as a distinct immunoglobulin class by Rowe and Fahey (1965). Subsequent studies have demonstrated antibody activity in this immunoglobulin class (Gelich et al., 1969). A problem in assessing differences in serum IgD levels in different populations or disease states is the very wide variation in concentration normally found. This is exemplified by the lack of a statistically significant difference in IgD levels between Australians and Papua New Guineans reported in the small samples in Chapter IX. When larger numbers were used however, statistically significant differences occurred.

Serum IgD levels were measured in 335 Australians with a mean age of 37 years and standard deviation of 16 years. Forty four percent were males and 56% were females. These measurements were compared with values obtained for 244 Papua New Guineans of similar age and sex distribution. The ages of individual Papua New Guineans could only be estimated however. There was a significantly higher mean IgD level ( $P < 0.001$ ) for Papua New Guinean subjects (Fig. 7.3).

Rowe et al (1968) found no differences in IgD levels between Gambian and healthy British adults. Nevertheless, the elevation of IgD levels seen in Papua New Guineans is not surprising as IgG, IgM, IgA and IgE levels were all elevated when compared with Australians (see Chapter IX).

Raised IgD levels may reflect frequent exposure to the antigenic stimulus of helminths, protozoa, fungi, bacteria and viruses common in the tropics (Wells, 1968).

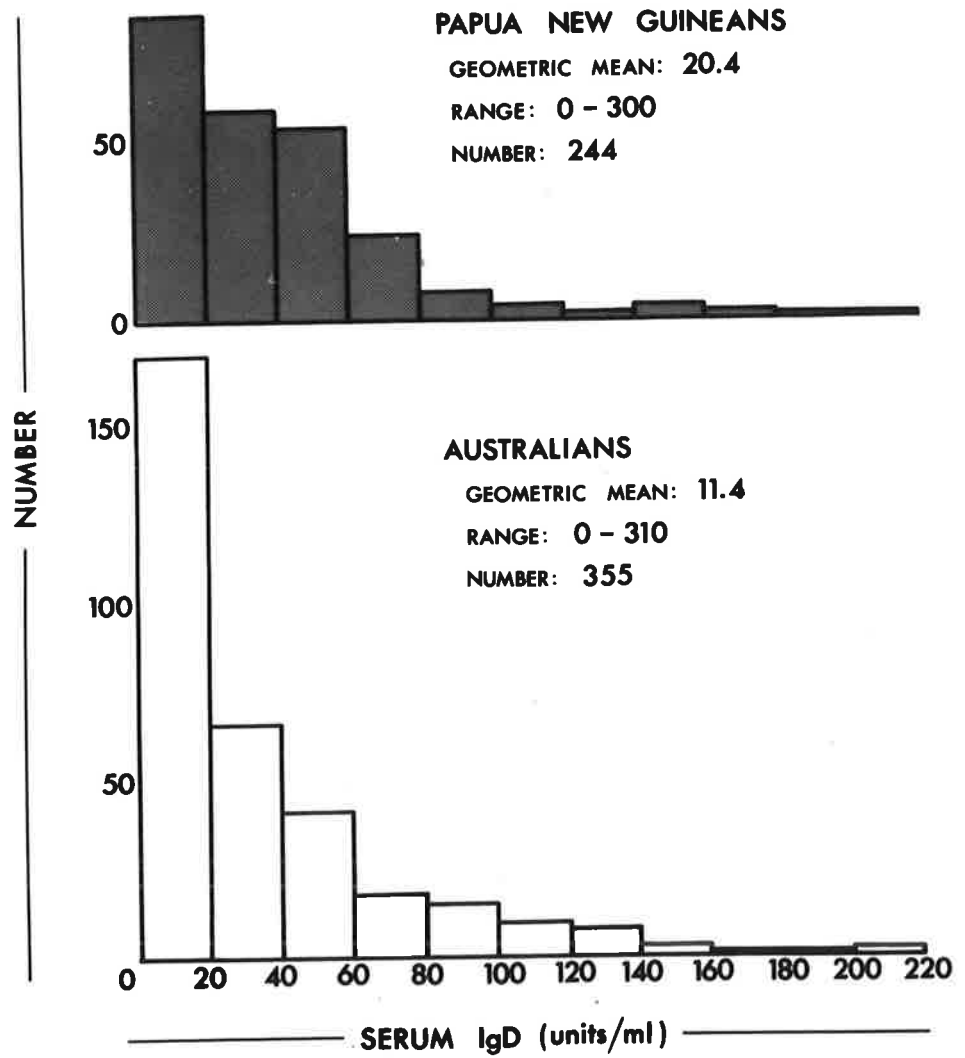

Fig. 7.3 Serum IgD concentrations in Papua New Guinean and Australian subjects.



IgD, HELMINTHIASIS AND ATOPY

Serum IgD levels were measured in asthmatic, non-asthmatic atopic and non-atopic subjects as described in Chapter V. No significant differences were found between the three groups.

Serum IgD (units/ml)

	Number	Mean	Range
Asthmatics	28	28	2-283
Non-asthmatic atopics	47	17	1-329
Normal Controls	90	24	2-298

In contrast to IgE, no evidence has been found to suggest a relationship between IgD, helminthiasis and atopy.

## CHAPTER VIII

### IMMUNOLOGICAL FUNCTION IN DYSTROPHIA MYOTONICA

Introduction	173
Patients and Methods	173
Results	174
Discussion	181
Summary	184

## INTRODUCTION

Reduced serum levels of gammaglobulin have been found in many patients with dystrophia myotonica by some workers (Lowenthal and van Sande, 1956; Kuhn and Weicker, 1957), but not by others. These reduced levels were observed to be associated with a reduction in the half life of  $^{131}\text{I}$ -labelled gammaglobulin (Zinneman and Rotstein, 1956). With the delineation of the various immunoglobulin classes, it was found that there were reduced serum levels and increased catabolism of IgG (Wochner et al., 1966), though a more recent report suggested that serum levels of IgM may also be reduced (Bundey et al., 1970).

These abnormalities prompted a more comprehensive investigation of immunological function in this disease.

## PATIENTS AND METHODS

Fifteen patients were studied, including two pairs of siblings and one mother and daughter. Each patient had characteristic clinical features and showed the classical electromyographic changes of dystrophia myotonica. It is difficult to be certain of the duration of clinical symptoms, but the average was ten years and ranged from five to 16 years. There were eight men and seven women, with ages ranging between 30 and 71 years (Table 8.2). Two patients were in institutions, the rest living at home. Two patients were receiving digoxin and diuretics for

congestive cardiac failure, and one was receiving bronchodilators for chronic bronchitis. One patient suffered from rheumatoid arthritis but was receiving no therapy, while another had peripheral vascular disease. Three were taking respectively quinine bisulphate, isopropamide iodide and an aspirin-codeine mixture. Patients were questioned about their immunization history. Most believed that they had been immunized with tetanus toxoid, though none remembered being immunized with typhoid vaccine.

Serum immunoglobulin and complement levels, spontaneous and phytohaemagglutinin-stimulated lymphocyte  $^3\text{H}$  thymidine uptake, DHS reactions to candida, mumps and streptococcal antigens, and antibody responses to tetanus and typhoid immunization were measured. Antibody titres were measured before and after treatment with mercaptoethanol.

Each patient was age and sex matched with a normal control subject.

## RESULTS

Serum immunoglobulin levels were not significantly different in patient and control groups (Table 8.1). Serum  $\beta_1\text{A}$  complement levels in the patient group were higher.

Antibody responses at two weeks after immunization are shown in Figures 8.1 and 8.2; no antibody to tetanus was detectable in eight subjects, while two patients failed to make antibody to S. typhi H antigen. Mercaptoethanol treatment of serum reduced typhoid antibody titres to zero or very low levels, while leaving tetanus antibody titres relatively unchanged. There was considerable overlap of the ages of the tetanus responders and non-responders (Table 8.2).

Delayed hypersensitivity skin reactions to the three antigens are shown in Table 8.3. The two patients who failed to make a reaction against any antigen were brothers.

Spontaneous uptake of  $^3\text{H}$  thymidine was lower in dystrophic patients (Table 8.4). PHA-stimulated uptake of  $^3\text{H}$  thymidine by lymphocytes was normal in the presence of both autologous and foetal calf serum.

Each parameter was compared in tetanus responders and non-responders. No significant differences were found.

Table 8.1

SERUM IMMUNOGLOBULIN & COMPLEMENT LEVELS

		No	Mean	S.D.	Probability
IgG	Patients	15	1,120	343	N.S.
	Controls	15	1,200	327	
IgA	Patients	15	231	68	N.S.
	Controls	15	216	69	
IgM	Patients	15	118 *	60	N.S.
	Controls	15	104 *	80	
IgD	Patients	15	36 *	39	N.S.
	Controls	15	15 *	66	
IgE	Patients	15	87 *	50	N.S.
	Controls	15	99 *	65	
$\beta_1$ A Complement		*			
	Patients	15	152	35	<0.05
	Controls	15	124	35	

\* Geometric Mean

N.S. = Not Significant

Units as in Table 2.1

 $\beta_1$ A Complement: mg/100 ml

Probability by Student's "t" test

Table 8.2

AGE AND TETANUS RESPONSE

	Ages
Tetanus Responders	30, 38, 47, 49, 53, 56, 60
Tetanus Non-responders	41, 45, 54, 55, 65, 65, 71

---

Table 8.3

SKIN TEST REACTION

	Reactors	Non- reactors	% of Reactors	Probability *
Patients	13	2	87	N.S.
Controls	15	0	100	

---

\* Probability by Fishers Exact Test

Table 8.4

LYMPHOCYTE  $^3\text{H}$  THYMIDINE UPTAKE †

		No	Mean	S.D.	Probability
PHA Autol $^3\text{H}$	Patients	15	56,500	41,200	N.S.
	Controls	15	69,700	45,000	
PHA F.C.S. $^3\text{H}$	Patients	15	39,700	29,400	N.S.
	Controls	15	45,100	24,000	
Spontaneous $^3\text{H}$	Patients	15	262*	168	<0.05
	Controls	15	382*	150	

\* Geometric Mean

† Disintegrations per culture per minute

Probability by Student's "t" test

N.S. = Not Significant



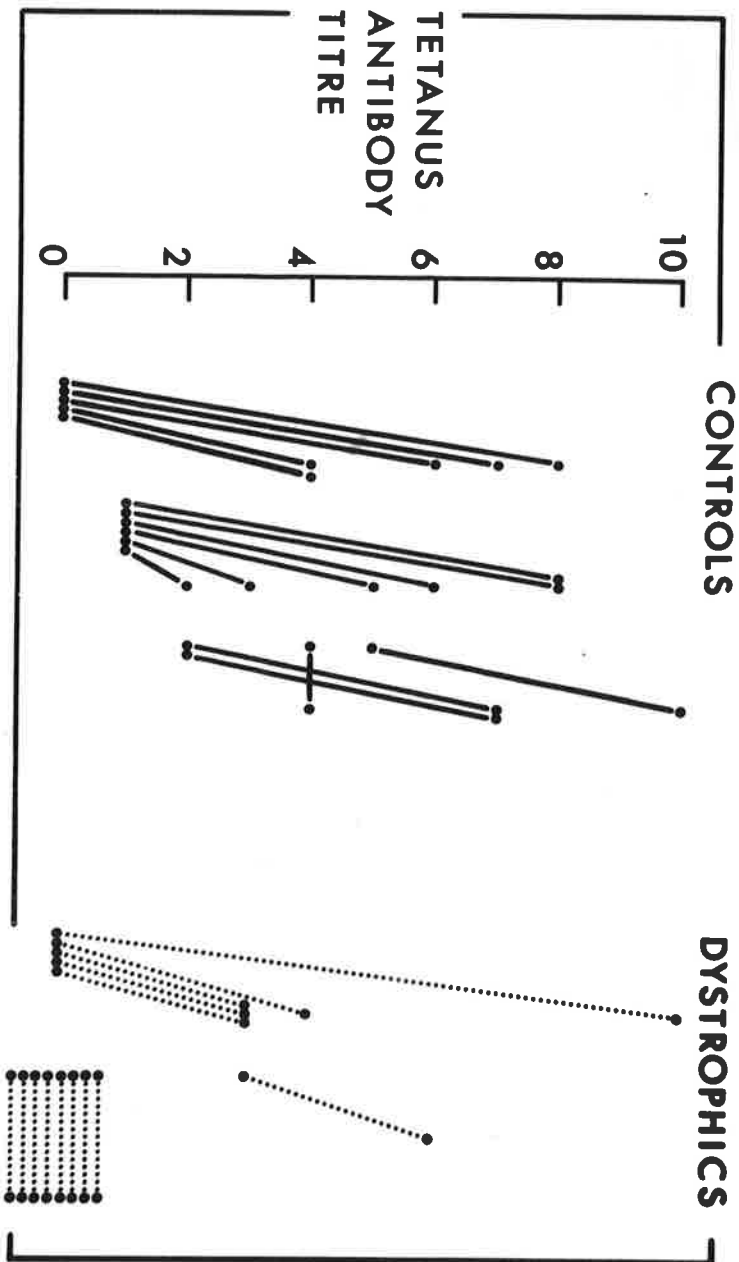

Fig. 8.1 Titres of antibody to tetanus toxoid before and after immunization. Each line represents an individual patient, with dot on left being pre- and that on the right post-immunization titre. Titre is  $\log_2$  of reciprocal of highest dilution at which haemagglutination was observed. Results were highly significant ( $P < 0.002$ , Fisher's Exact Test).

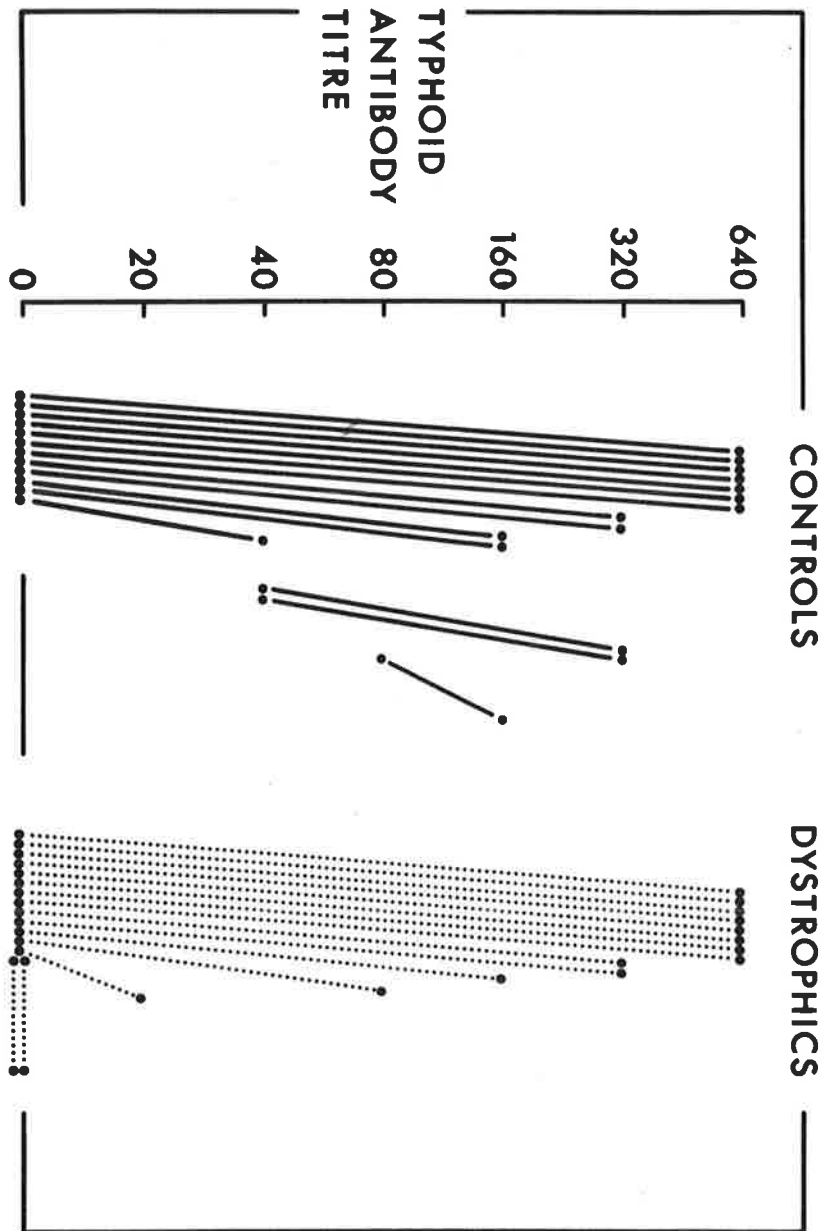

Fig. 8.2 Titres of antibody to *S. typhi* H antigen before and after immunization. Titres is reciprocal of highest dilution at which agglutination was observed. Zero point actually indicates no agglutination at a dilution of 1 in 10. Results were not statistically significant.

## DISCUSSION

Dystrophia myotonica is a multisystem disorder. Reports of abnormalities in IgG serum levels and metabolism suggested it would be worth investigating other parameters of immunological function.

Contrary to several reports, no significant differences in the serum level of IgG were found. Oppenheimer and Milhorat (1961) also failed to find reduced IgG levels. In series which reported low levels of IgG in the dystrophic group, many individual patients had values which fell within the normal range. This suggests that measurement of serum immunoglobulin levels is a crude index of immunological abnormality in these patients. No significant differences were found with the other immunoglobulin classes. The significance of raised levels of  $\beta_1A$  complement levels is obscure.

The most striking finding was the failure of about 50% of patients to make antibody to tetanus antigen. The absence of change in titre after mercaptoethanol treatment in those who did respond, is consistent with the general observation in South Australians that tetanus immunization produces an IgG response. Measurement of antibody response to tetanus is probably relatively a sensitive test of humoral immunological capacity. It seems unlikely that the failure to make antibody is related to age, as the ages of

the groups responding to tetanus immunization are similar to those of the group who did not respond. Moreover, all patients were age matched with controls, all of whom did respond. There is no evidence that failure to respond to could be attributed to inter-current infection or drug therapy. The measurement of a specific IgG antibody response may be a more sensitive indicator of impaired IgG production than measurement of total IgG levels.

Failure of two subjects to make antibody to S. typhi is additional evidence of impairment of humoral immune responses. S. typhi is a potent antigen and failure to make this antibody is almost always associated with clinically apparent disease (Forbes, personal communication).

No statistical indication of impaired cellular immunity was found in this study, although two patients, brothers, failed to make DHS skin reactions. The uptake of  $^3\text{H}$  thymidine by PHA-stimulated lymphocytes was normal in these two patients, as in the group as a whole.

The spontaneous uptake of tritiated thymidine was reduced. As discussed earlier, this parameter is probably a measure of the activity of circulating immunoreactive cells (Crowther et al., 1969; Horwitz et al., 1970). The same phenomenon of reduced spontaneous uptake was observed in those asthmatic patients who failed to respond to tetanus immunization. It has previously been shown that catabolism

of IgG is increased in dystrophia myotonica (Wochner et al., 1966). These authors concluded that the synthesis of IgG was normal. Reduced spontaneous uptake of  $^3\text{H}$  thymidine together with impaired response to tetanus immunization suggests that synthesis of specific antibody may be reduced in this condition.

Dystrophia myotonica is inherited as an autosomal dominant trait and often does not present until later in life (Walton, 1969). It may be informative to study the capacity of young members of afflicted families to produce specific antibody. It is possible that such a failure may antedate clinical presentation of the disease.

## SUMMARY

Parameters of humoral and cellular immunity have been measured in 15 patients with dystrophia myotonica. No abnormalities in total serum levels of the five major immunoglobulin classes were found, but there was a rise in the mean serum level of  $\beta_1A$  complement. Fifty four percent of patients failed to make antibody to tetanus toxoid as compared with 1% of controls; 13% of patients failed to make antibody to S. typhi H antigen as compared with no failure of this function in control subjects. There was a reduced spontaneous uptake of  $^3H$  thymidine by lymphocytes, while in the presence of PHA and autologous or foetal calf serum, the uptake was normal. Thirteen percent of subjects failed to make DHS reactions to intradermal antigen.

It is suggested that there may be a wider derangement of immunological function in dystrophia myotonica than previously thought.

## CHAPTER IX

### IMMUNOLOGICAL FUNCTION IN PAPUA NEW GUINEA HIGHLANDERS

Introduction	185
Subjects and Methods	185
Results	
(a) Immunoglobulin Levels	188
(b) Antibody Responses	188
(c) Albumin Levels	189
(d) Autoantibodies	190
(e) DHS Reactions	190
(f) Australia Antigen	191
Discussion	199
Summary	202

## INTRODUCTION

Mass immunization campaigns are a major weapon in the control of communicable disease in the tropics. The effectiveness of such campaigns depends upon the ability of those immunized to produce an effective immunological response. The opportunity was taken, while in Papua New Guinea, to assess by simplified techniques appropriate for field conditions, humoral and cellular immune competence in Highland Papua New Guineans.

## SUBJECTS AND METHODS

Two groups of Papua New Guineans were investigated and the results compared with those found in healthy adult Australians.

### PNG Group 1:

Forty two adult members of Kefaio village via Kwongi in the upper Asaro Valley were studied (Fig. 9.1). The village was located at an altitude of 2,400 metres in mountainous terrain, 55 km from Goroka. The staple foodstuff was sweet potato, with an occasional admixture of meat during pig feasts. Despite the cool climate, most villages wore only the scanty traditional clothing. They lived in smoke-filled huts. Upper and lower respiratory tract infections were common. Only minimal medical care was available.



PNG Group 2:

Thirty eight adult males who had been inmates of the Goroka prison for more than three months were studied. The prison, at an altitude of 1,600 metres, was located several kilometres from Goroka. They received a more nutritious diet, including daily meat, wore more clothing, lived in better housing, and were more accessible to medical care. Respiratory tract infections were not prominent.

Malaria is uncommon in the Eastern Highlands District.

Subjects were venepunctured for measurement of serum immunoglobulin levels, autoantibodies, Australia antigen, and baseline antibody levels. Subjects were immunized with tetanus toxoid and typhoid vaccine and venepunctured again two weeks later. Twenty eight subjects in Group 2 were re-immunized approximately one month after the first immunization, and assessed again after a further two weeks. DHS reactions were measured to Candida albicans, Mumps Skin Test Antigen and Streptokinase-Streptodornase at 48 hours in PNG Group 1.



Fig. 9:1a Kefaio Village, Eastern Highlands District.

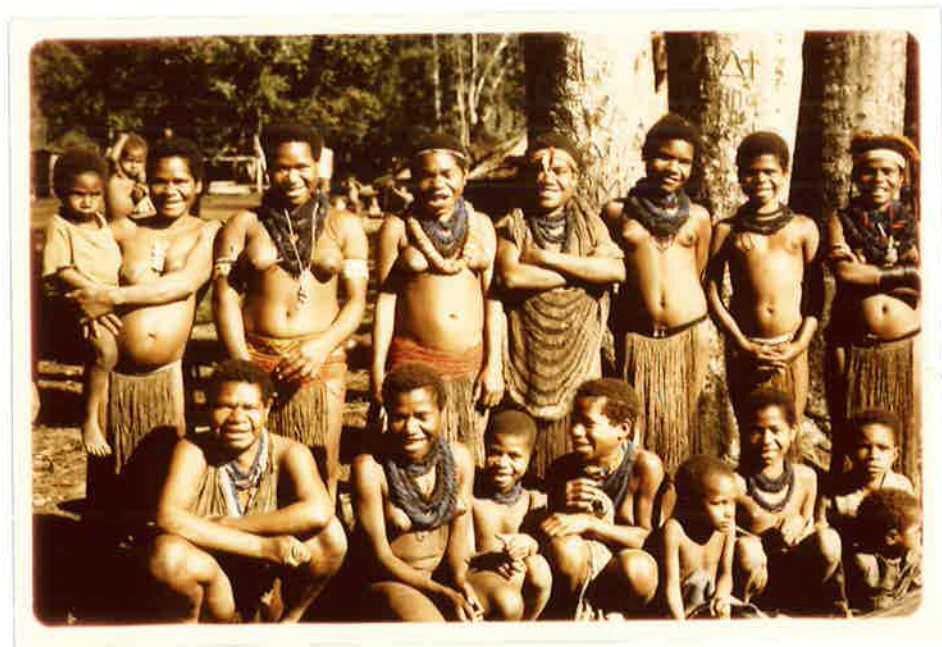

Fig. 9:1b Belles of Kefaio.

## RESULTS

### Immunoglobulin Levels

Serum immunoglobulin levels are shown in Table 9.1. IgG, IgA, IgM and IgE are all significantly elevated in both PNG groups when compared with Australians. There was no differences between the two PNG groups for these parameters, but IgD levels in Group 1 were significantly greater than those in Group 2 ( $P < 0.005$ , "t" test).

### Antibody Responses

Antibody responses in tetanus toxoid immunization (Figs. 9.2 and 9.3) were greatly impaired in both PNG groups compared with Australians ( $P < 0.0001$ , Fisher's Exact Test). Tetanus haemagglutinating antibodies were not detectable two weeks after immunization in 34 of 42 (81%) subjects in PNG Group 1, 22 of 37 (59%) of subjects in PNG Group 2 and none of 59 (0%) Australians. There was a significantly greater impairment of antibody responsiveness in PNG Group 1 than PNG Group 2 ( $P < 0.025$ , Fisher's Exact Test). There were no differences in immunoglobulin levels between tetanus responders and tetanus non-responders. There was a slow decline in tetanus antibody titre in those patients who did respond to immunization and were measured at both two and six weeks after immunization. Twenty eight patients in Group 2 were re-immunized (Fig. 9.4). Fifteen of these had failed to respond on first immunization, and nine (60%)

failed to respond on repeat immunization. Eleven of the thirteen who had responded on first immunization, had increased titres after the second immunization.

Antibody responses to immunization with typhoid vaccine (Fig. 9.5) were also impaired in both PNG groups compared with Australians ( $P < 0.0005$ ,  $\chi^2$ , Brandt and Snedecor's Formula). Titres were lower in PNG Group 1 than in PNG Group 2, but not at a statistically significant level.

Three patients in Group 2 who failed to respond to immunization with typhoid vaccine were re-immunized. All responded to repeat immunization.

Sera of nine subjects who responded to immunization, were treated with mercaptoethanol and antibody titres measured. Five subjects had an IgM response after the initial tetanus immunization, while four had a predominantly IgG response. Re-immunization produced an IgG response in all except two subjects. All subjects had a predominantly IgM response after initial typhoid immunization, while re-immunization was associated with a mixed IgG and IgM response.

#### Albumin Levels

Serum albumin levels (Table 9.2) were reduced in both PNG groups compared with Australians. This reduction was greater in Group 1 than Group 2 ( $P < 0.001$ , "t" test).

Tetanus non-responders had a lower mean serum albumin, but not at a statistically significant level. Subjects who developed a typhoid titre of 1:20 or less had a significantly lower mean serum albumin level than those who developed a titre of 1:40 or more ( $P < 0.05$ , "t" test).

#### Autoantibodies

Autoantibodies were measured in 68 subjects. Mitochondrial and gastric parietal cell antibodies were not detected, antinuclear factor was found in one subject, and smooth muscle antibodies in seven subjects (10%). These figures do not differ from the normal Australian population apart from smooth muscle antibodies which are found in about 5% of the population (value established for normal subjects by The Queen Elizabeth Hospital).

#### DHS Reactions

The prevalence of DHS reactions to candida, mumps and streptococcal antigens was similar to that found in the Australian population (Fig. 9.6). Only 2% of subjects failed to react to one of the three antigens which is comparable to the figure of 1% for Australians. Reactions to PHA were similar to those seen in Australians. No subject failed to react to at least one of the three antigens or PHA.

Australia Antigen

Australia Antigen was found in seven of 76 sera (9%) compared with less than half of one percent in the Australian population. (Value established for normal subjects by The Queen Elizabeth Hospital.)

Table 9.1

IMMUNOGLOBULIN LEVELS

		Number	Mean	S.D.	Probability †
IgG	PNG Group 1	42	3340	1100	<0.001
	PNG Group 2	38	3240	1500	<0.001
	Australians	80	1560	320	
IgA	PNG Group 1	42	240	70	<0.02
	PNG Group 2	38	230	55	<0.05
	Australians	80	200	75	
IgM*	PNG Group 1	42	200	80	<0.001
	PNG Group 2	38	190	80	<0.001
	Australians	80	150	75	
IgD*	PNG Group 1	42	27	85	N.S.
	PNG Group 2	38	10	30	N.S.
	Australians	80	16	70	
IgE*	PNG Group 1	42	2250	6450	<0.001
	PNG Group 2	38	2100	6500	<0.001
	Australians	80	120	110	

\* Geometric Mean

† Compared with Australians, Student's "t" test.

Units as in Table 2.1

Table 9.2

SERUM ALBUMIN LEVELS †

	Number	Mean	S.D.
PNG Group 1	41	2.95	.52
PNG Group 2	38	3.47	.55
Australians	24	3.68	.46
Tetanus Responders	22	3.37	.58
Tetanus Non-Responders	57	3.12	.62
Typhoid Titres $\geq$ 1:40	52	3.30	.56
Typhoid Titres $\leq$ 1:20	27	3.00	.68

† gm/100 ml



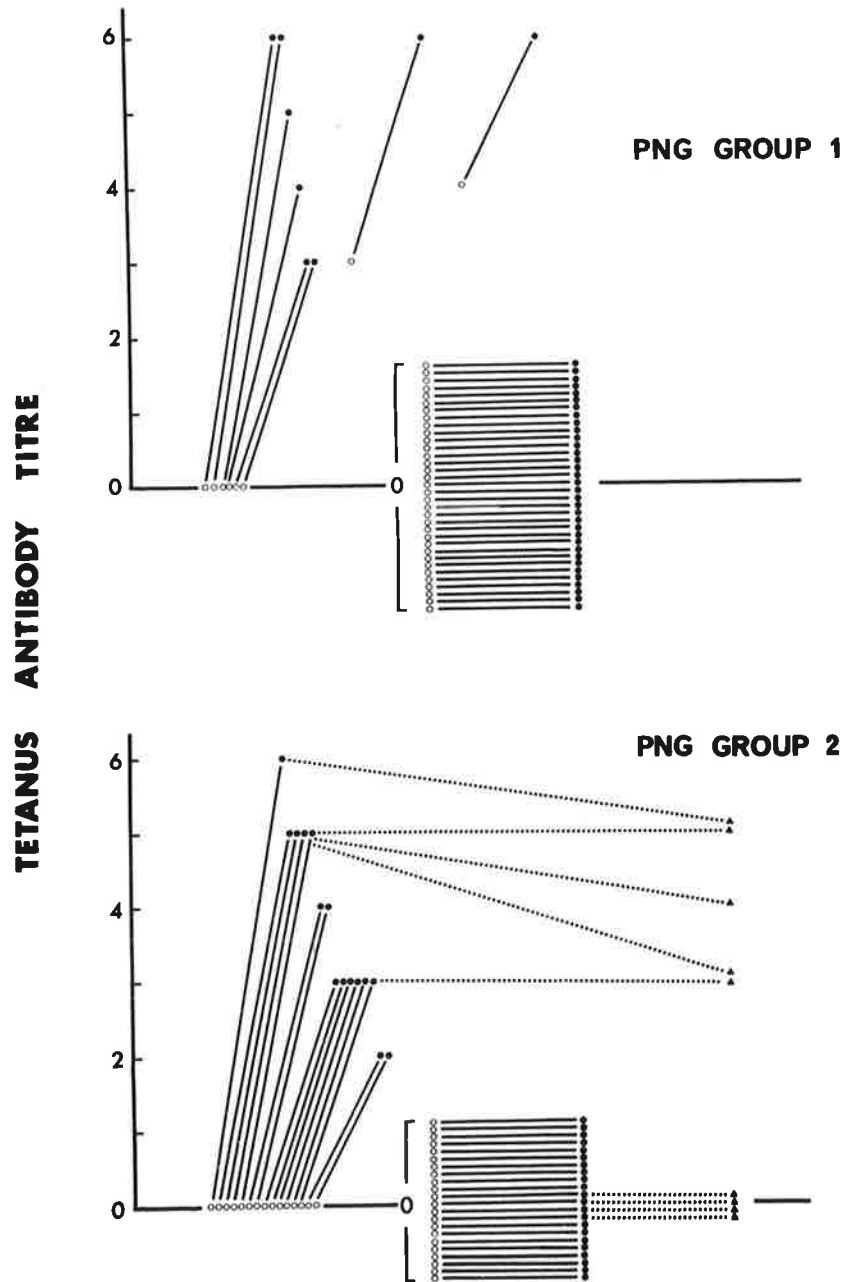

Fig. 9.2 Titres of antibody to tetanus toxoid. o represents pre-immunization titre, • represents post-immunization titre and ...Δ titre after six weeks. Titre is  $\log_2$  of reciprocal of highest dilution at which haemagglutination was observed. PNG Group 1 are villagers and Group 2 are prisoners.

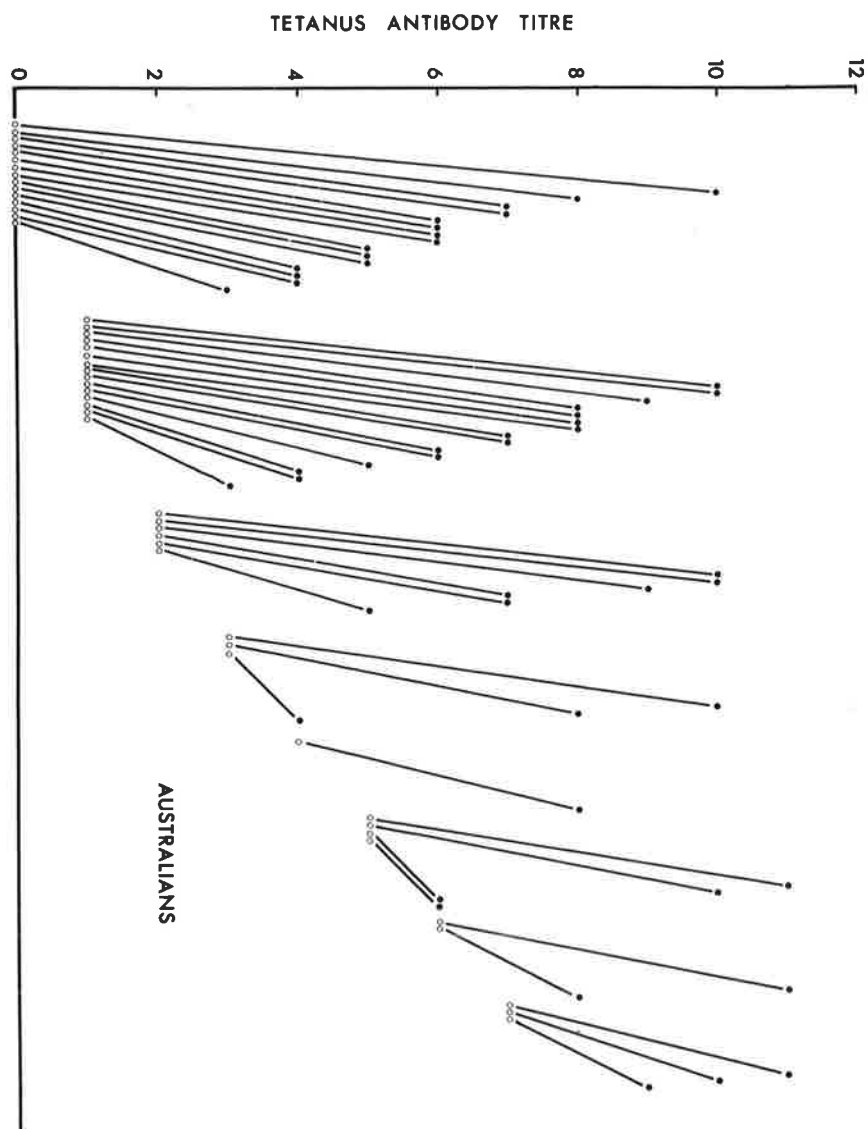

Fig. 9.3 Titres of antibody to tetanus toxoid in Australians. o represents pre-immunization titre and . post-immunization titre.

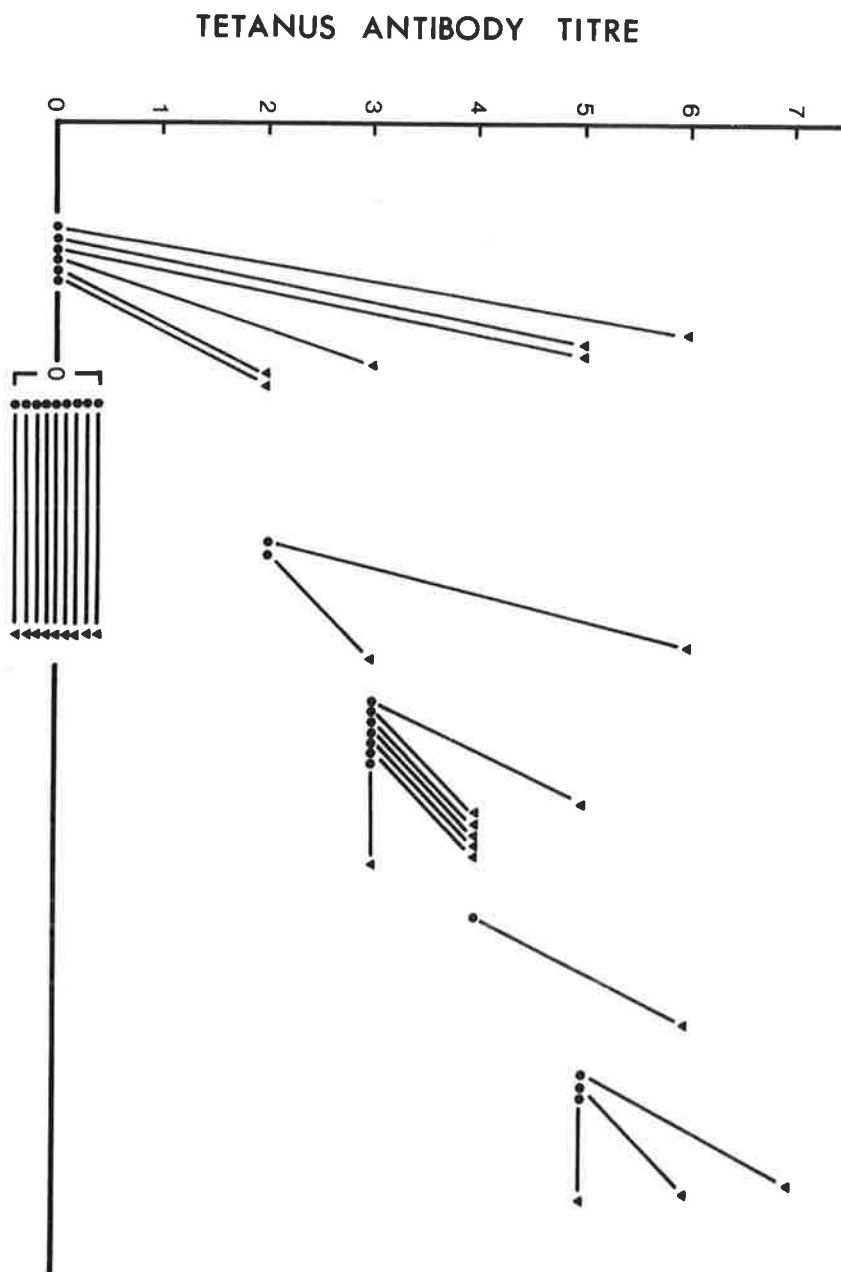

Fig. 9.4 Titres of antibody to tetanus toxoid in Papua New Guineans after re-immunization. • represents titre two weeks after first immunization and ∇ two weeks after second immunization.

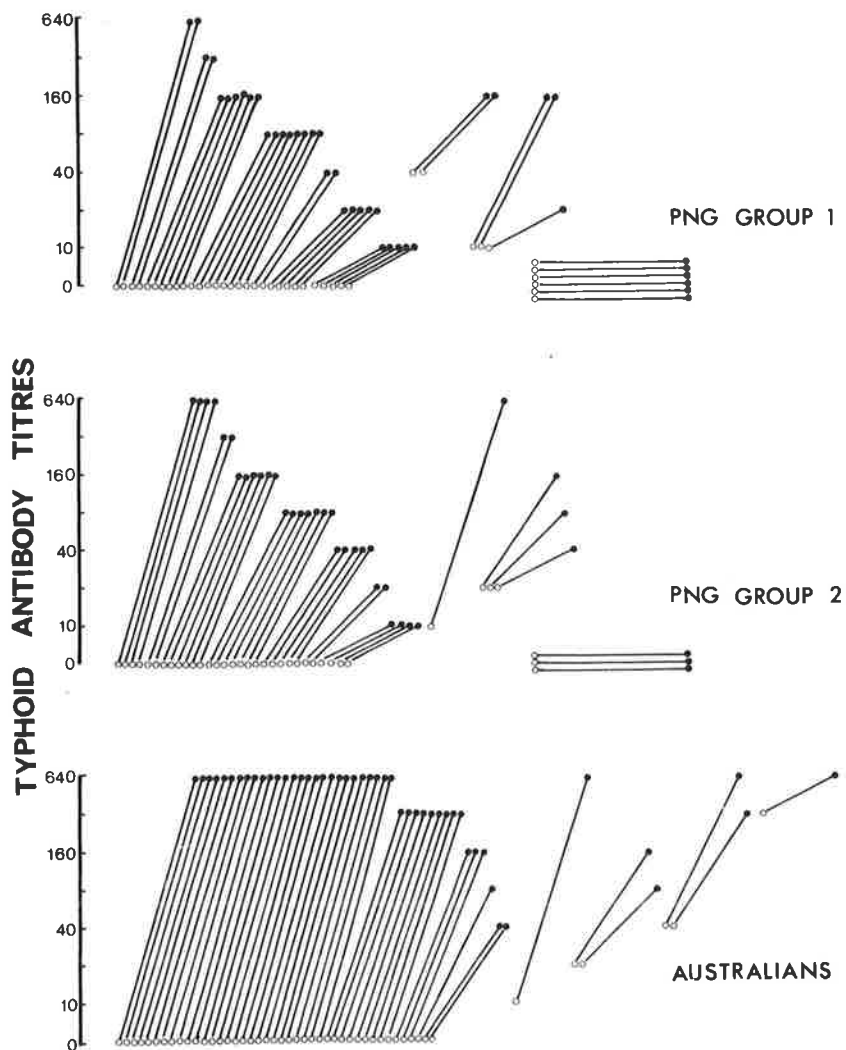

Fig. 9.5 Titres of antibody to *S. typhi* antigen. o represents pre-immunization and • post-immunization titre. Titre is reciprocal of highest dilution at which agglutination was observed. Zero point actually indicates no agglutination at a dilution of 1:10.

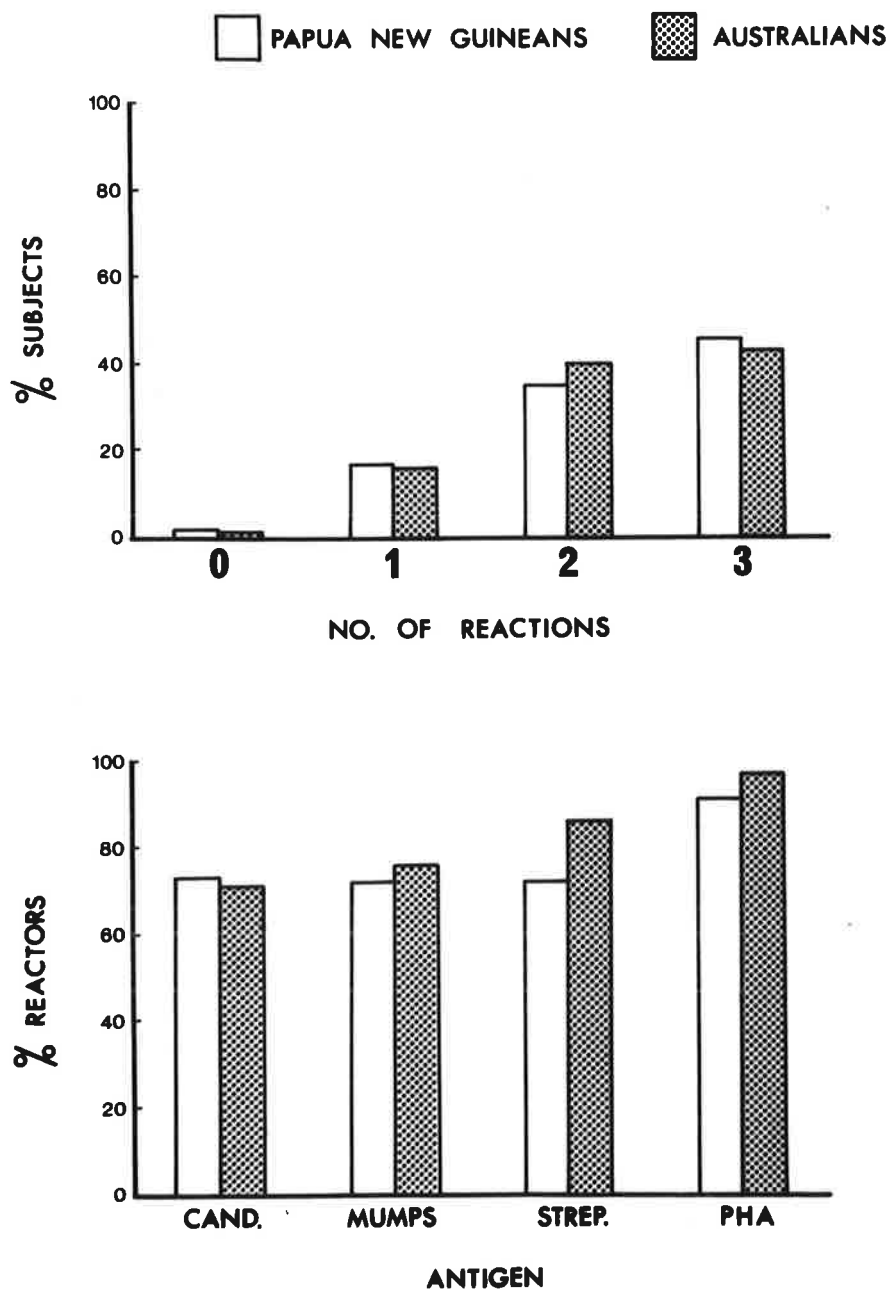

Fig. 9.6 Delayed hypersensitivity reactions to candida, mumps and streptococcal antigens and to phytohaemagglutinin, expressed as the percentage of subjects reacting to a given number of antigens, and the percentage of reactors to individual antigens or PHA.

## DISCUSSION

Marked depression of humoral immunity has been found in Papua New Guinea Highlanders, as compared with healthy Australians. This has been shown by substantially impaired capacity to make antibodies to tetanus and S. typhi H antigens. In contrast, cellular immunity as assessed by DHS skin reactions was intact. Similar, but less marked findings were reported from the Gambia, where 50% of normal controls failed to respond to tetanus immunization, although normal responses were found to S. typhi H antigen and DHS skin tests (Greenwood et al., 1972, 1973).

Raised serum levels of IgG, IgA and IgM have been reported from lowland regions of Papua New Guinea (Wells, 1970), while Crane et al (1971) showed raised levels of IgG and IgM but normal levels of IgA compared with healthy Australians. Frequent exposure to the antigenic stimulus of helminths, protozoa, fungi, bacteria and viruses is the most likely cause of the high immunoglobulin levels seen in the tropics (Wells, 1968). Such exposure may also impair antibody responses to tetanus and typhoid immunization by "antigenic competition". This phenomenon occurs when antibody response to one antigen is reduced by prior contact with a second unrelated antigen and is observed in many species and with a wide variety of antigens (Michaelis, 1902; Barr and Llewellyn-Jones, 1955; Adler, 1964).

Impaired antibody responsiveness has been shown in chronic infections (Lee, 1971; Forbes, 1971), including malaria (McGregor and Barr, 1962). Chronic respiratory, gastro-intestinal and cutaneous infections are frequent in the population studied, but malaria is not common. Depression of humoral immunity has been shown in mildly protein-deprived animals (Jose and Good, 1972). Gross protein deficiency, as in kwashiorkor may lead to depression of cell-mediated immunity (Smythe et al., 1971). Kwashiorkor was not seen here. The depression of antibody response in Papua New Guineans was greater in villagers than prisoners. Serum albumin levels were less in Papua New Guineans than in Australians, the reduction being most marked in the villagers. This parameter also, may reflect a poor protein diet or chronic infection. It seems likely that impaired antibody responsiveness is multi-factorial in origin, resulting from the interplay of diet, clothing, housing, chronic infection and adequacy of medical care, these factors being less favourable for villagers than prisoners.

Antibody response after first immunization was predominantly in the IgM class for both tetanus and typhoid vaccines, with conversion to the IgG class on re-immunization. IgG antibody after the first exposure presumably reflects previous exposure, whether naturally or as a result of mass immunization campaigns. Re-immunization with tetanus toxoid induced a detectable antibody response in about

half the subjects who had failed to respond to the first immunization. This is comparable with the results obtained when Australians suffering from chronic infections and who failed to respond to tetanus immunization were re-immunized, (Forbes, 1971).

The high prevalence of Australia antigen in the serum confirms the observations of others (Woodfield, 1973). It may be another marker of impaired immunity. The high prevalence, nearly 10%, suggests that Australia antigenaemia may be prolonged. While this may in part be due to increased exposure, it may also indicate defective immunological handling of the virus, as immunodeficiency has been suggested as an explanation for the high prevalence of Australia antigenaemia in a variety of disease states such as leprosy, leukaemia, and Down's Syndrome (Campion, 1973).

This study has important implications for mass immunization campaigns. It cannot be assumed that a procedure which has been shown to be effective in a temperate environment in a developed country will necessarily be effective in a developing country in the tropics. It would seem worthwhile to carry out pilot studies in such countries to assess the efficacy of a proposed programme. Should the result be less than desired, further investigation with increased doses of antigen, and different schedules of immunization is warranted. Such manipulations, in association with improved standards of living and hygiene, may lead



to improved effectiveness of mass immunization campaigns.

### SUMMARY

Serum immunoglobulin and albumin levels, antibody responses to tetanus and typhoid immunization, and delayed hypersensitivity reactions to intradermal antigens have been measured in two groups of Papua New Guineans and compared with Australians. Normal delayed hypersensitivity reactions, but raised immunoglobulin levels, low albumin levels and impaired antibody responses were found. Albumin levels were lower and antibody responses more impaired in the group with the more adverse environmental circumstances.

REFERENCES

- Adler, F.L. Competition of antigens. *Progr. Allergy* (1964) 8: 41.
- Alexander, H.L. Reactions with drug therapy (1955) Saunders, Philadelphia publishers.
- Anderson, L.G. and Talal, N. The spectrum of benign to malignant lymphoproliferation in Sjogren's Syndrome. *Clin. Exp. Immunol.* (1972) 10: 199.
- Archer, R.K. The eosinophil leucocytes (1963) Blackwells, Oxford.
- Bach, J.F., Dormont, J., Dardenne, M. and Balner, H. In vitro rosette inhibition by antihuman antilymphocyte serum. *Transplantation* (1969) 8: 265.
- Baer, R.L. Multiple eczematous sensitivities. *J.A.M.A.* (1959) 170: 1041.
- Bailey, N.T.J. Statistical methods in biology (1973) English Universities Press, London.
- Barr, M. and Llewellyn-Jones, M. Some factors influencing the response to immunization with single and combined prophylactics. *Brit. J. Exp. Path.* (1955) 36: 147.
- Behring and Kitasato (1890) Quoted in Dubos, R. "Bacterial and mycotic infections of man" (1958) J.P. Lippincott, Montreal publishers.
- Bennich, H., Ishizaka, K., Johansson, S.G.O., Rowe, D.S., Stanworth, D.R. and Terry, W.D. Immunoglobulin E: A new class of human immunoglobulin. *Immunology* (1968) 15: 323.
- Bennich, H., Ishizaka, K., Ishizaka, T. and Johansson, S.G.O. A comparative antigenic study of  $\gamma$ E globulin and myeloma IgND. *J. Immunol.* (1969) 102: 826.
- Beraldo, W.T. Formation of bradykinin in anaphylactic and peptone shock. *Am. J. Physiol.* (1950) 163: 283.

- Berg, T. and Johansson, S.G.O. IgE concentrations in children with atopic diseases. A clinical study. *Int. Arch. Allergy* (1969) 36: 219.
- Biroum-Noerjasin. Serum IgE concentrations in relation to antihelminthic treatment in a Javanese population with hookworm. *Clin. Exp. Immunol.* (1972) 13: 545.
- Blackley, C. Experimental researches on the causes and nature of catarrhus aestivus (hay fever or hay-asthma). Bailliere Tindall & Cox, 1873. Quoted in excerpts from *Classics in Allergy* Ed. M. Samter (1969) Ross Laboratories publishers.
- Blaese, R.M., Weiden, P., Oppenheim, J.J. and Waldmann, T.A. Phytohaemagglutinin as a skin test for the evaluation of cellular immune competence in man. *J. Lab. Clin. Med.* (1973) 81: 538.
- Bostock, J. A case of a periodical affection of the eyes and chest. *Med. Chir. Trans.* (1819) 10: 161. Quoted in excerpts from *Classics in Allergy* Ed. M. Samter (1969) Ross Laboratories publishers.
- Botallo, Leonardo. De catarrho commentarius. Parisiis, apud B. Turrisanum, 1564. Quoted in Garrison and Morton's *Medical Bibliography*. Ed. Morton 2nd Ed. 1954. Grafton & Co., London.
- Brocklehurst, W.E. Occurrence of an unidentified substance during anaphylactic shock in cavy lung. *J. Physiol.* (1953) 120: 16P.
- Brown, F., Cartwright, B. and Newman, J.F.E. Further studies of the early antibody in the sera of cattle and guinea pigs infected with foot and mouth disease virus. *J. Immunol.* (1964) 93: 397.
- Brown, W.R., Lansford, C.L. and Hornbrook, M. Serum IgE concentrations in patients with gastrointestinal disorders. *Am. J. Dig. Dis.* (1973) 18: 641.
- Bryant, D.H., Burns, M.W. and Lazarus, L. New type of allergic asthma due to IgG "Reaginic" antibody. *Brit. Med. J.* (1973) 4: 589.

- Buckley, R.H., Dees, S.C. and O'Fallon, W.M. Serum immunoglobulins: Levels in normal children and in uncomplicated childhood allergy. *Pediatrics* (1968) 41: 600.
- Bunday, S., Carter, C.D. and Soothill, J.F. Early recognition of heterozygotes for the gene for dystrophia myotonica. *J. Neurol. Neurosurg. Psychiat.* (1970) 33: 279.
- Calnan, C.D. Nickel dermatitis. *Brit. J. Derm.* (1956) 68: 229.
- Campion, E.C. Role of Au antigen in other diseases. *Bull. Post-grad. Comm. Med. Univ. Sydney* (1973) 29: No. 4: 31.
- Caron, G.A. Nickel sensitivity and atopy. *Brit. J. Derm.* (1964) 76: 384.
- Catalona, W.J., Taylor, P.T., Rabson, A.S. and Chretien, P.B. A method for dinitrochlorobenzene contact sensitization. *New Engl. J. Med.* (1972) 286: 399.
- Charrin and Roger (1889) Quoted in "Bacterial and mycotic infections of man". R. Dubos (1958) J.P. Lippincott, Montreal publishers.
- Cheah, J.S. and Kan, S.P. Lack of association between helminthic infestations and bronchial asthma in Singapore. *Aust. N.Z. J. Med.* (1972) 4: 383.
- Coca, A.F. and Cooke, R.A. On the classification of the phenomena of hypersensitiveness. *J. Immunol.* (1923) 8: 163.
- Coca, A.F. and Grove, E.F. Studies in hypersensitiveness. A study of the atopic reagins. *J. Immunol.* (1925) 10: 445.
- Cole, M.B. and Roberts, F.E. Inflammatory response to histamine in atopic and non-atopic individuals. *J. Allergy* (1966) 38: 26.

- Collins-Williams, C., Tkachyk, S.J., Toft, B., Generosos, L. and Moscarello, M. IgG, IgA and IgM in children with intractable asthma. *Ann. Allergy* (1967) 25: 177.
- Cooke, R.A. and Vander Veer, A. Human sensitization. *J. Immunol.* (1916) 1: 201.
- Cooper, M.D., Raymond, D.A., Peterson, R.D.A., South, M.A. and Good, R.A. The functions of the thymus system and the bursa system in the chicken. *J. Exp. Med.* (1966) 123: 75.
- Crane, G.G., Pitney, W.R., Hobbs, J.R. and Gunn, C. Immunoglobulin levels in the Kaiapit and upper Watut areas of New Guinea. *Trans. Roy. Soc. Trop. Med. Hyg.* (1971) 65: 795.
- Cronin, E., Bandmann, H.J., Calnan, C.D., Fregert, S., Hjorth, N., Magnusson, B., Maibach, H.I., Maltén, K., Menenghini, V., Pirila, V. and Wilkinson, D.S. Contact dermatitis in the atopic. *Acta Derm-venereol.* (1970) 50: 183.
- Crowther, D., Fairley, G.H. and Sewell, R.L. Lymphoid responses in the blood after immunization in man. *J. Exp. Med.* (1969) 129: 849.
- Dacie, J.V. *Practical haematology.* 4th Edition (1968) J. & A. Churchill Ltd., London publishers.
- Date, H. and Laidlaw, P.P. The physiological action of  $\beta$ -iminazolyethylamine. *J. Physiol.* (1911) 41: 318. Quoted in excerpts from *Classics in Allergy*, Ed. M. Samter (1969) Ross Laboratories publishers.
- Davies, A.J.S., Carter, R.L., Leuchars, E., Wallis, V. and Dietrich, F.M. The morphology of immune reactions in normal, thymectomized and reconstituted mice II. Response to bacterial antigens. *Immunology* (1970) 19: 945.
- Dawkins, R.L. and Zilko, P.J. Rosette sedimentation for separation of human T and B cells. *Lancet* (1973) 1: 368.
- Di Conza, J.J. Protective action of passively transferred serum and immunoglobulin fractions against tissue invasive stages of the dwarf tapeworm, Hymenolepis nana. *Exp. Parasit.* (1969) 25: 368.

- Dinitria, A., Debray-Sachs, M., Descamps, B., Sultan, C. and Hamburger, J. Tritiated thymidine incorporation in blood leucocytes of renal allograft patients. *Transplant. Proc.* (1971) 3: 1577.
- Dineen, J.K. and Adams, D.B. The effect of long-term lymphatic drainage on the lymphomyeloid system in the guinea pig. *Immunology* (1970) 19: 11.
- Dineen, J.K., Ogilvie, B.M. and Kelly, J.D. *Immunology* (in the press) quoted by Kelly, J.D. (1973) *Aust. Vet. J.* 49: 91.
- Dixon, W.J. and Massey, F.J. Introduction to statistical analysis. 3rd edition (1969) McGraw Hill publishers.
- Dragstedt, C.A. and Gebaur-Fuelnegg, E. Studies in anaphylaxis: The appearance of a physiologically active substance during anaphylactic shock. *Am. J. Physiol.* (1932) 102: 512.
- Elliotson, J. Hay fever. *London Medical Gazette* (1831) 8: 411. Quoted in Garrison and Morton's *Medical Bibliography*, Ed. Morton, 2nd Ed. 1954. Grafton & Co., London publishers.
- Epstein, S. Neomycin sensitivity and atopy. *Dermatologica* (1965) 130: 280.
- Epstein, S. and Mohajerin, A.H. Incidence of contact sensitivity in atopic dermatitis. *Arch. Derm.* (1964) 90: 284.
- Feinberg, A.R., Feinberg, S.M. and Lee, F. Leukocytes and hypersensitivity reactions. *J. Allergy* (1966) 40: 73.
- Field, E.J. and Caspary, E.A. Inhibition of lymphocyte response by serum. *Lancet* (1971) 2: 95.
- Fjelde, A. and Kopecka, B. Cell transformation and mitogenic effects in blood leucocyte cultures of atopic dermatitis patients. *Acta Derm-venereol.* (1967) 47: 168.
- Forbes, I.J. Measurement of immunological function in clinical medicine. *Aust. N.Z. J. Med.* (1971) 2: 160.

- Ford, R.M. Aetiology of asthma: A review of 11,551 cases (1955-1968). *Med. J. Aust.* (1969) 1: 628.
- Ford, W.H., Caspary, E.A. and Shenton, B. Purification and properties of a lymphocyte inhibition factor from human serum. *Clin. Exp. Immunol.* (1973) 15: 169.
- Forsbeck, M., Skog, E. and Yherborn, K.H. The frequency of allergic disease among relatives of patients with allergic eczematous contact dermatitis, XIII Congressus. *Intern Dermat. Munchen.* 1967: 268.
- Fregert, S. and Moller, H. Contact allergy to balsam of peru in children. *Brit. J. Derm.* (1963) 75: 218.
- Froland, S. and Natvig, J.B. Surface-bound immunoglobulin as a marker of B lymphocytes in man. *Nature New Biology* (1971) 234: 251.
- Gelich, G.J., Bieger, R.C. and Stankievic, R. Antigen combining activity associated with IgD. *Science* (1969) 165: 606.
- Gold, E.R. and Fudenberg, H.H. Chromic chloride: A coupling reagent for passive haemagglutination reactions. *J. Immunol.* 99: 859.
- Gordon, H.McL. and Whitlock, H.V. A new technique for counting nematode eggs in sheep faeces. *J. Coun. Scient. Ind. Res. Aust.* (1939) 12: 50.
- Gowans, J.L. and McGregor, D.D. The immunological activities of lymphocytes. *Progr. Allergy* (1965) 9: 1.
- Greenert, S., Bernstein, I.L. and Michael, J.G. Immune responses of non-atopic individuals to prolonged immunization with ragweed extract. *Lancet* (1971) 2: 1121.
- Greenwood, B.M., Bradley-Moore, A.M., Palit, A. and Bryceson, A.D.M. Immunosuppression in children with malaria. *Lancet* (1972) 1: 169.
- Greenwood, B.M., Whittle, H.C. and Molyneux, D.H. Immunosuppression in Gambian trypanosomiasis. *Trans. Roy. Soc. Trop. Med. Hyg.* (1973) 67: 846.

- Gurevitch, A.W., Heiner, D.C. and Reisner, R.M. IgE in atopic dermatitis and other common dermatoses. Arch. Derm. (1973) 107: 712.
- Harada, Y. and Mori, U. A new method for culturing hookworm. Yonaga Acta Med. (1955) 1: 177.
- Harrison's Principles of Internal Medicine. Wintrobe, M.M. et al Editors (1970) McGraw-Hill publishers.
- Heiner, D.C. and Rose, B. Elevated levels of IgE in conditions other than classical allergy. J. Allergy (1970) 45: 30.
- Henderson, L.L., Swedlund, H.A., Van Dellen, R.G., Marcoux, J.P., Carryer, H.M., Peters, G.A. and Gleich, G.J. Evaluation of IgE tests in an allergy practice. J. Allergy Clin. Immunol. (1971) 48: 361.
- Heremans, J.F. and Vaerman, J.P.  $\beta_2$ A-Globulin as a possible carrier of allergic reaginic activity. Nature (1962) 193: 1091.
- Hess, M.W. Experimental Thymectomy (1968) Springer-Verlag Berlin, Heidelberg and New York Publishers.
- Hobbs, J.R. Paraproteins, benign and malignant? Brit. Med. J. (1967) 2: 699.
- Hobbs, J.R. In immunology and development (1969) ed. M. Adinolfi, London.
- Hobbs, J.R., Hepner, G.W., Douglas, A.P., Crabbe, P.A. and Johansson, S.G.O. Immunological mystery of coeliac disease. Lancet (1969) 2: 649.
- Hogarth-Scott, R.C., Johansson, S.G.O. and Bennich, H. Antibodies to Toxocara in the sera of visceral larva migrans patients. Clin. Exp. Immunol. (1969) 5: 619.
- Horwitz, D.A., Stastny, P. and Ziff, M. Circulating DNA-synthesizing mononuclear leucocytes I. J. Lab. Clin. Med. (1970) 76: 391.



- Humphrey, J.H. and White, R.C. Immunology for students of medicine. (1970) 3rd Edition, Blackwell, Oxford publishers.
- Huntley, D.C., Lyerly, A. and Winston-Salem, N.C. Immune globulin determinations in allergic children. Am. J. Dis. Child. (1963) 106: 545.
- Ishizaka, K., Ishizaka, T. and Hornbrook, M.M. Physico-chemical properties of reaginic antibody IV. Presence of a unique immunoglobulin as a carrier of reaginic activity. J. Immunol. (1966a) 97: 75.
- Ishizaka, K., Ishizaka, T. and Hornbrook, M.M. Physico-chemical properties of reaginic antibody V. Correlation of reaginic activity with  $\gamma$ E globulin antibody. J. Immunol. (1966b) 97: 840.
- Ishizaka, T., Ishizaka, K., Johansson, S.G.O. and Bennich, H. Histamine release from human leucocytes by anti-IgE antibodies. J. Immunol. (1969) 102: 884.
- Ito, K., Sawada, T. and Sato, S. Increased serum IgE levels in individuals infected with Schistosoma japonicum, Wuchereria bancrofti or hookworm. Jap. J. Exp. Med. (1972) 42: 115.
- Ishizaka, K., Tonioko, H. and Ishizaka, T. Mechanisms of passive sensitization. J. Immunol. (1970) 105: 1459.
- Janossy, G. and Greaves, M.F. Lymphocyte activation II. Discriminating stimulation of lymphocyte subpopulations by phytomitogens and heterologous antilymphocyte sera. Clin. Exp. Immunol. (1972) 10: 525.
- Jarrett, E.E.E. and Stewart, D.C. Potentiation of rat reaginic (IgE) antibody by helminth infection. Simultaneous potentiation of separate reagins. Immunology (1972) 23: 749.
- Jarrett, E.E.E. and Stewart, D.C. Potentiation of rat reaginic (IgE) antibody by Nippostrongylus brasiliensis infection: Effect of modification of the life cycle of the parasite in the host. Clin. Exp. Immunol. (1973) 15: 79.

- Jasani, M.K. Possible modes of action of ACTH and glucocorticoids in allergic diseases. Clin. Allergy (1972) 2: 1.
- Jillson, O.F., Curwen, W.L. and Alexander, B.R. Problems of contact dermatitis in the atopic individual with reference to neomycin and ragweed oil sensitivity. Ann. Allergy (1959) 17: 215.
- Johansson, S.G.O. Raised levels of a new immunoglobulin class (IgND) in asthma. Lancet (1967) 2: 951.
- Johansson, S.G.O. and Bennich, H. Immunological studies of an atypical (myeloma) immunoglobulin. Immunology (1967) 13: 381.
- Johansson, S.G.O., Bennich, H., Berg, T. and Hogman, C. Some factors influencing the serum IgE levels in atopic diseases. Clin. Exp. Immunol. (1970) 6: 43.
- Johansson, S.G.O., Mellbin, T. and Vahlquist, B. Immunoglobulin levels in Ethiopian pre-school children with special reference to high concentrations of IgE. Lancet (1968) 1: 1118.
- Jones, V.E., Edwards, A.J. and Ogilvie, B.M. The circulating immunoglobulins involved in protective immunity to the intestinal stage of Nippostrongylus brasiliensis in the rat. Immunology (1970) 18: 621.
- Jose, D.G. and Good, R.A. Immune resistance and malnutrition. Lancet (1972) 1: 314.
- Juhlin, L., Johansson, S.G.O. and Bennich, H. IgE in dermatoses: Levels in atopic dermatitis and urticaria. Arch. Derm. (1969) 100: 12.
- Junge, U., Hoekstra, J., Wolfe, L. and Deinhardt, F. Microtechnique for quantitative evaluation of in vitro lymphocyte transformation. Clin. Exp. Immunol. (1970) 7: 431.
- Kabat, E.A. and Mayer, M.M. Experimental immunochemistry (1961) Chartes C. Thomas, Springfield publishers.

- Kaufman, H.S. and Hobbs, J.R. Immunoglobulin deficiencies in an atopic population. *Lancet* (1970) 2: 1061.
- Kellaway, C.H. and Trethewic, E.R. The liberation of a slow-reacting smooth muscle-stimulating substance in anaphylaxis. *Quart. J. Exp. Physiol.* (1940) 30: 121.
- Kelly, J.D. Immunological suppression of parasite rejection by removal of selected lymphocyte populations. *Aust. J. Exp. Biol. Med. Sci.* (1972) 50: 477.
- Kelly, J.D. Mechanisms of immunity to intestinal helminths. *Aust. Vet. J.* (1973) 49: 91.
- Kissling, M. and Speck, B. Simple micromethod for testing phytohaemagglutinin response of lymphocytes. *Lancet* (1972) 1: 451.
- Knud Faber (1890) Quoted in Dubos, R. "Bacterial and Mycotic Infections in Man" (1958). Lippincott, Montreal publishers.
- Kraus (1897) Quoted in "Bacterial and Mycotic Infections in Man" (1958). Lippincott, Montreal publishers.
- Kuhn, V.E. and Weicher, H. Serumproteins und lipide bei myotonischer dystrophia. *Schweiz. med. Wschr.* (1957) 37: 58.
- Kuhns, W.J. and Pappenheimer, A.M. Immunochemical studies of antitoxin produced in normal and allergic individuals hyperimmunized with diphtheria toxoid. *J. Exp. Med.* (1952) 4: 363.
- Kumar, L., Newcomb, R.W. and Hornbrook, M.M. A year round study of serum IgE levels in asthmatic children. *J. Allergy* (1971a) 48: 305.
- Kumar, L., Newcomb, R.W., Ishizaka, K., Middleton, E. and Hornbrook, M.M. IgE levels in sera of children with asthma. *Paediatrics* (1971b) 47: 848.
- Lancet*. Cellular immunity in leprosy: Leading article. (1969) 2: 253.

- Lancet. Mechanisms of Eosinophilia: Leading article.  
(1971) 2: 1187.
- Langley, R. Practical statistics (1970) Pan Books, London publishers.
- Lee, A.K.Y., MacKay, I.R. and Rowley, M. Measurement of antibody-producing capacity in man III. Int. Arch. Allergy (1971a) 41: 358.
- Lee, A.K.Y., MacKay, I.R., Rowley, M.J. and Yap, C.Y. Measurement of antibody-producing capacity to flagellin in man IV. Clin. Exp. Immunol. (1971b) 9: 507.
- Leskowitz, S. and Lowell, F.C. A comparison in immunologic and physiologic responses of normal and allergic individuals. J. Allergy (1961) 32: 152.
- Leskowitz, S., Salvaggio, J.E. and Schwartz, H.J. An hypothesis for the development of atopic allergy in man. Clin. Allergy (1972) 2: 237.
- Levine, B.B. and Vaz, N.M. Effect of combinations of inbred strain, antigen dose on immune responsiveness and reagin production in the mouse. Int. Arch. Allergy Appl. Immunol. (1970) 39: 156.
- Ling, N.R. Lymphocyte stimulation (1968) North-Holland Publishing Co., Amsterdam.
- Lobitz, W.C., Honeyman, J.F. and Winkles, N.W. Suppressed cell-mediated immunity in two adults with atopic dermatitis. Brit. J. Derm. (1972) 86: 317.
- Lowenthal, A. and Van Saude, M. Nouvelle determinations des fraction proteiniques dans le serum de patients atteints d'affections musculaires. Rev. Franc. Etud. Clin. Biol. (1956) 1: 765.
- McConahey, P.J. and Dixon, F.J. A method of trace iodination of proteins for immunologic studies. Int. Arch. Allergy (1966) 29: 185.

- McDevitt, H., Bechtol, K., Grumet, C., Mitchell, G. and Wegmann, T. Genetic control of the immune response to branched synthetic polypeptide antigens in inbred mice. *Progr. Immunol.* (1971) Ed. B. Amos, Academic Press, New York publishers.
- McGregor, I.A. and Barr, M. Antibody response to tetanus toxoid inoculation in malarious and non-malarious Gambian children. *Trans. Roy. Soc. Trop. Med. Hyg.* (1962) 36: 364.
- Magendie, F. Lectures in the blood, 1839. Harrington, Barrington and Haswell, Philadelphia. Quoted in Garrison and Morton's Medical Bibliography Ed. Morton, 2nd Ed. 1954, Grafton & Co., London publishers.
- Magnusson, B., Fregert, S., Hjorth, N., Houding, G., Pirila, V. and Skog, E. Routine patch testing V. Fifth report by the Scandinavian Committee for standardization of routine patch testing. *Acta Derm-venereol.* (1969) 49: 556.
- Mancini, G., Carbonara, A.O. and Heremans, J.F. Immunochemical quantitation of antigens by single radial immunodiffusion. *Int. J. Immunochem.* (1965) 2: 235.
- Marsh, D., Hsu, S. and Bias, W. Tests of association between HL-A histocompatibility antigens and immediate hypersensitivity reactions to highly purified allergens in man. *J. Allergy Clin. Immunol.* (1972) 49: 124.
- Metchnikoff, 1883. Quoted in "Bacterial and Mycotic Infections in Man". R. Dubos (1958). Lippincott, Montreal publishers.
- Michaelis, L. Untersuchungen uber Eiweissprazipitine. *Dtsch. Med. Wschr.* (1902) 28: 773.
- Miller, J.F.A.P. and Mitchell, G.F. Thymus and antigen-reactive cells. *Transplantation Rev.* (1969) 1: 3.
- Miller, J.F.A.P. and Osaba, D. Current concepts of the immunological function of the thymus. *Physiol. Rev.* (1967) 47: 437.
- Miller, T.A. Vaccination against canine hookworm disease. *Adv. Parasit.* (1971) p. 153.

- Momma, K. Immunochemical and semiquantitative estimation of  $\gamma$ M and  $\gamma$ A globulins in healthy and diseased children. *Acta Paediat. Jap.* (1965) 7: 1.
- Newble, D.I. Immune reactions in viral hepatitis. M.D. Thesis, University of Adelaide (1974).
- Nowell, P.C. Phytohaemagglutinin: An initiator of mitosis in cultures of normal human leucocytes. *Cancer Res.* (1960) 20: 462.
- Ogawa, M. IgE in atopic dermatitis. *Arch. Derm.* (1971) 103: 575.
- Ogilvie, B.M. Passive protection with cells or antiserum against Nippostrongylus brasiliensis in the rat. *Parasitology* (1968) 58: 939.
- Ogilvie, B. and Jones, V. Nippostrongylus brasiliensis: A review of immunity and the host-parasite relationship in the rat. *Parasitology* (1971) 29: 138.
- Oppenheimer, H.A. and Milhorat, A.T. Serum proteins, lipoproteins and glycoproteins in muscular dystrophia and related diseases. *Ann. N.Y. Acad. Sci.* (1961) 94: 308.
- Orr, T.S.C. and Blair, A.M.J.N. Potentiated reagin responses to egg-albumin and conalbumin in Nippostrongylus brasiliensis infected rats. *Life Sciences* (1969) 8: 1073.
- Paradine, C.J. and Rivett, B.H.P. *Statistical Methods for technologists* (1960) English Universities Press, 1st Ed.
- Park, B.H. and Good, R.A. A new micromethod for evaluating lymphocyte responses to phytohaemagglutinins quantitative analysis of the function of thymus-dependent cells. *Proc. Nat. Acad. Sci. (Wash.)* (1972) 69: 371.
- Parratt, J.R. and West, G.B. 5-hydroxytryptamine and tissue mast cells. *J. Physiol.* (1957) 137: 169, 179.
- Pediatrics. Primary immunodeficiencies: Report of a WHO Committee. *Pediatrics* (1971) 47: 927.

- Perlmann, P., Perlmann, H. and Holm, G. Cytotoxic action of stimulated lymphocytes on allogenic and autologous erythrocytes. *Science* (1968) 160: 306.
- Pirquet von C. Allergie. *Munch Med. Wochenschr* (1906) 53: 1457. Quoted in excerpts from *Classics in Allergy* Ed. M. Samter (1969) Ross Laboratories publishers.
- Pirquet von C. 1907. Quoted in "Bacterial and Mycotic Infections in Man". R. Dubos (1958) Lippincott, Montreal publishers.
- Portier, P. and Richet, C.R. De l'action anaphylactique de certains venins C.R. Soc. Biol. (Paris) (1902) 54: 170. Quoted in excerpts from *Classics in Allergy* Ed. M. Samter (1969) Ross Laboratories publishers.
- Prausnitz, C. and Kustner, H. Studien uber uberempfindlichkeit. *Centralbl. f. Bakteriol. 1 Abst Orig.* (1921) 86: 160. Quoted in excerpts from *Classics in Allergy*. Ed. M. Samter (1969) Ross Laboratories publishers.
- Rackemann, F.M. A clinical study of 153 cases of bronchial asthma. *Arch. Int. Med.* (1918) 22: 552.
- Rackemann, F.M. Professor Willem Storm van Leeuwen and the asthma problem. *Acta allerg. (Kbh)* (1958).
- Rajka, G. Studies in hypersensitivity to moulds and staphylococci in Prurigo Besnier (atopic dermatitis). *Acta Derm-venereol.* (1963) 43 Suppl. 54.
- Rajka, G. Delayed reactivity to bacterial and viral extracts in different dermatoses. *Acta Derm-venereol.* (1970) 50: 281.
- Read, K.E. *The High Valley* (1966) George Allen and Unwin publishers.
- Reed, C. Beta adrenergic blockade, bronchial asthma and atopy. *J. Allergy* (1968) 42: 238.

- Reerink-Brougers, E.E., Stoop, J.W., Groen, A.S., Van Lookeren Campagne, J.G., Feltkamp, T.E.W., v.d. Veer, M., Callianw, J.O. and Sander, P.C. IgE levels, antibodies against smooth muscle and eosinophilia in asthmatic patients and normal controls. *Int. Arch. Allergy* (1973) 44: 233.
- Riley, S.F. and West, G.B. Histamine in tissue mast cells. *J. Physiol.* (1952) 117: 72P.
- Rook, A., Wilkinson, D.S. and Ebling, F.J.C. *Textbook of Dermatology*. 1972. Blackwell, Oxford publishers.
- Rosenberg, E.B., Polmar, S.H. and Whalen, G.E. Increased circulating IgE in trichinosis. *Ann. Int. Med.* (1971) 75: 575.
- Rosenberg, E.B., Whalen, G.E., Bennich, H. and Johansson, S.G.O. Increased circulating IgE in a new parasitic disease, human intestinal capillariasis. *New Engl. J. Med.* (1970) 283: 1148.
- Rostenberg, A. and Sulzberger, M.B. Some results of patch tests. *Arch. Derm-Syph. (Chic.)* (1937) 35: 433.
- Rothwell, T.L.W., Dineen, J.K. and Love, R.J. The role of pharmacologically active amines in the resistance to Trichostrongylus colubriformis in the guinea pig. *Immunology* (1971) 21: 925.
- Roux and Yessin (1888) Quoted in Dubos, R. "Bacterial and Mycotic Infections in Man". (1958) Lippincott, Montreal publishers.
- Rowe, D.S. Radioactive single radial diffusion: A method for increasing the sensitivity of immunochemical quantification of proteins in agar gel. *Bull. WHO.* (1969) 40: 613.
- Rowe, D.S. and Fahey, J.L. A new class of human immunoglobulins II. Normal serum IgD. *J. Exp. Med.* (1965) 121: 185.
- Rowe, D.S., McGregor, I.A., Smith, S.J., Hall, P. and Williams, K. Plasma immunoglobulin concentrations in a West African (Gambian) community and in a group of healthy British adults. *Clin. Exp. Immunol.* (1968) 3: 63.



- Rowe, D.S. and Wood, C.B.S. The measurement of serum IgE levels in healthy adults and children with allergic asthma. *Int. Arch. Allergy* (1970) 39: 1.
- Rowley, M.J., Wistar, R. and MacKay, I.R. Measurement of antibody-producing capacity in man: Immunoglobulin classes of antibodies to flagellin. *Immunology* (1972) 22: 475.
- Sabesin, S.M. A function of the eosinophil: Phagocytosis of antigen-antibody complexes. *Proc. Soc. Exp. Biol. Med.* (1963) 112: 667.
- Salvaggio, J., Castro-Murillo, E. and Kundur, V. Immunologic response of atopic and normal individuals to key-hole limpet haemocyanin. *J. Allergy* (1969) 44: 344.
- Salvaggio, J.E., Cavanaugh, J.J.A., Lowell, F.C. and Leskowitz, S. A comparison of the immunologic responses of normal and atopic individuals to intranasally administered antigen. *J. Allergy* (1964) 35: 62.
- Salvaggio, J.E., Kayman, H. and Leskowitz, S. Immunologic responses of atopic and normal individuals to aerosolized dextran. *J. Allergy* (1966) 38: 31.
- Scadding, J.G. Meaning of diagnostic terms in broncho-pulmonary disease. *Brit. Med. J.* (1963) 2: 1425.
- Schild, H.O., Hawkins, D.F., Mongar, J.L. and Herxheimer, H. Reactions of isolated human asthmatic lung and bronchial tissue to a specific antigen. *Lancet* (1951) 2: 376.
- Schwartz, H.J. and Kalin, B. Hymenoptera sensitivity II. The role of atopy in the development of clinical hypersensitivity. *J. Allergy* (1970) 45: 87.
- Schwartz, H.J., Leskowitz, S. and Lowell, F.C. Studies on intrinsic allergic respiratory disease with a hypothesis concerning its pathogenesis. *J. Allergy* (1968) 42: 169.
- Schwartz, H.J. and Terr, A.I. The immune response of allergic and normal subjects to pneumococcal polysaccharide. *Int. Arch. Allergy* (1971) 40: 520.

- Sharp, J.C.M. and Fletcher, W.B. Experience of anti-vaccinial immunoglobulin in the United Kingdom. *Brit. Med. J.* (1973) 1: 656.
- Sherman, W.B. Heredity and antigen exposure in the development of atopic disease. *Immunological Diseases* (1965) Ed. by Samter, M. and Alexander, H.L., Little Brown & Co., Boston publishers.
- Silveira, N.P.A., Mendes, N.A. and Tolnai, M.E.A. Tissue localization of two populations of human lymphocytes distinguished by membrane receptors. *J. Immunol.* (1972) 108: 1456.
- Sinclair, I.J. The relationship between circulating antibodies and immunity to helminthic infections. *Adv. Parasit.* (1970) p. 97.
- Skog, E. and Thyresson, N. The occupational significance of some common contact allergens. *Acta Derm-venereol.* (1953) 33: 65.
- Smythe, P.M., Schonland, M., Brereton-Stiles, G.G., Coovadia, H.M., Grace, H.J., Loening, W.E.K., Mafoyane, A., Parent, M.A. and Vos, G.H. Thymolympathic deficiency and depression of cell-mediated immunity in protein-calorie malnutrition. *Lancet* (1971) 2: 939.
- Somei Kojima, Muneo Yokogawa and Tomio Tada. Raised serum levels of IgE in human helminthiases. *Am. J. Trop. Med. Hyg.* (1972) 21: 913.
- Soothill, J.F. and Steward, M.W. The relationship of allergic disease to immunodeficiency. *Int. Arch. Allergy Appl. Immunol.* (1973) 45: 180.
- Sorrell, T.C. Anticonvulsants in immunosuppression and carcinogenesis. M.D. Thesis, University of Adelaide (1974).
- Stanworth, D.R. Immediate Hypersensitivity. *Frontiers of Biology Series* (1973) Vol. 28. North-Holland, Amsterdam publishers.
- Stone, S.P., Muller, S.A. and Gleich, G.J. IgE levels in atopic dermatitis. *Arch. Derm.* (1973) 108: 806.

- Szentivanyi, A. The beta adrenergic theory of the atopic abnormality in bronchial asthma. *J. Allergy* (1968) 42: 203.
- Tada, T. and Ishizaka, K. Distribution of IgE forming cells in lymphoid tissues of the human and monkey. *J. Immunol.* (1970) 104: 377.
- Taylor, B., Norman, A.P., Ogel, H.A., Stokes, C.R., Turner, M.W. and Soothill, J.F. Transient IgA deficiency and pathogenesis of infantile atopy. *Lancet* (1973) 2: 111.
- Taylor, K.B., Roitt, I.M., Doniach, D., Couchman, K.G. and Shapland, C. Antibodies as detected by the immunofluorescent sandwich technique. *Brit. Med. J.* (1962) 2: 1347.
- Terry, R.J. The application of immunology to helminth diseases in "Immunity to parasites". (1968) Ed. A.E.R. Taylor, Blackwell, Oxford publishers.
- Townley, R.G., Dennis, M.M. and Itkin, I.H. Comparative action of acetyl-beta-methylcholine, histamine and pollen antigens in subjects with hay fever and bronchial asthma. *J. Allergy* (1965) 36: 121.
- Tullis, D.C.H. Bronchial asthma associated with intestinal parasites. *New Engl. J. Med.* (1970) 282: 370.
- Turner Warwick, M. and Haslam, P. Smooth muscle antibody in bronchial asthma. *Clin. Exp. Immunol.* (1970) 7: 31.
- Uvnas, B. and Wold, J.K. Isolation of a mast cell degranulating polypeptide from Ascaris suis. *Acta Physiol. Scand.* (1967) 70: 269.
- Van Dellen, R.G. and Thompson, J.H. Absence of intestinal parasites in asthma. *New Engl. J. Med.* (1971) 285: 146.
- Varelzidis, A., Wilson, A.B., Meara, R.H. and Turk, J.L. Immunoglobulin levels in atopic eczema. *Brit. Med. J.* (1966) 2: 925.
- Wagland, B.M. and Dineen, J.K. *Aust. J. Exp. Biol. Med. Sci.* (1965) 43: 429.

- Walton, J.N. Diseases of Voluntary Muscle (1969) 2nd Edition, Churchill, London publishers.
- Wells, J.V. Serum Immunoglobulin levels in tropical splenomegaly syndrome in New Guinea. Clin. Exp. Immunol. (1968) 3: 943.
- Wells, J.V. Immunological studies in tropical splenomegaly syndrome. Trans. Roy. Soc. Trop. Med. Hyg. (1970) 64: 531.
- Wilcocks, C. and Manson-Baler, P.E.C. Manson's Tropical Diseases (1972) 17th Edition. Bailliere Tindall & Cox.
- Williams, D.A. In the nature of asthma. A symposium held at King Edward VII Hospital, Midhurst (1964).
- Williams, H. and McNicol, K.N. Prevalence, natural history, and relationship of wheezy bronchitis and asthma in children. Brit. Med. J. (1969) 4: 321.
- Wilson, H.T.H. Standard patch tests in eczema and dermatitis. Brit. J. Derm. (1955) 67: 291.
- Wilson, J.D. and Nossal, G.J.V. Identification of human T and B lymphocytes in normal peripheral blood and in chronic lymphatic leukaemia. Lancet (1971) 2: 788.
- Wochner, R.D., Drews, G., Strober, W. and Waldmann, T.A. Accelerated breakdown of IgG in myotonic dystrophy. J. Clin. Invest. (1966) 45: 321.
- Wood, C.B.S., and Oliver, J. Serum IgE in asthmatic children: Relations to age, sex, eczema and skin sensitivity tests. Arch. Dis. Child. (1972) 47: 890.
- Wood, T.A. and Frenkel, E.P. The atypical lymphocyte. Am. J. Med. (1967) 42: 923.
- Woodfield, D.G. Studies of Australia antigen in Papua New Guinea. Bull. Postgrad. Comm. Med. Univ. Sydney (1973) 29, No. 4: 53.

Wybran, J., Chantler, S. and Fudenberg, H.H. Human blood T cells: Response to phytohaemagglutinin. J. Immunol. (1973) 110: 1157.

Zinneman, H.H. and Rotstein, J. A study of gamma globulins in dystrophia myotonica. J. Lab. Clin. Med. (1956) 47: 907.

## APPENDIX

Several factors must be considered for the proper interpretation of Table 4. 2b. In the immunologically intact person, reactions to the second and third antigens are not related to reaction or non-reaction to the first antigen. Reaction to each antigen is determined independently, presumably depending upon previous exposure to each antigen. In patients with depressed cell-mediated immunity however, there may be a linkage of response in that such patients are likely to fail to react to any number of antigens. This may artificially inflate the level of statistical significance. Nevertheless the results are consistent with Table 4. 2a which demonstrates impairment of cell-mediated immunity as assessed by delayed hypersensitivity reactions.