

Fundamental bigroupoids and 2-covering spaces

David Michael Roberts

Thesis submitted for the degree of
Doctor of Philosophy
in the School of Mathematical Sciences
University of Adelaide



December 2009

Contents

Abstract	v
Statement of originality	vii
Acknowledgements	ix
Introduction	1
Chapter 1. Internal categories and anafunctors	11
1. Internal categories and groupoids	11
2. Sites and covers	15
3. Weak equivalences	19
4. Anafunctors	22
5. Localising bicategories at a class of 1-cells	28
6. Anafunctors are a localisation	31
Chapter 2. A fundamental bigroupoid for topological groupoids	41
1. Preliminaries on topological groupoids and n -partitions	42
2. Paths and surfaces in topological groupoids	51
3. Thin homotopies and structure morphisms	58
4. 2-tracks	64
5. Compositions and concatenations	71
6. The fundamental bigroupoid	76
7. Calculations and comparisons	96
Chapter 3. Interlude: Pointed topological anafunctors	125
Chapter 4. 2-covering spaces I: Basic theory	135
1. Review of covering spaces	135
2. Locally trivial and weakly discrete groupoids	140
3. 2-covering spaces	147
4. Lifting of paths and surfaces	153
5. 2-covering spaces and bundle gerbes	168
Chapter 5. 2-covering spaces II: Examples	173
1. Some topology on mapping spaces	173
2. The topological fundamental bigroupoid of a space	182
3. The canonical 2-connected cover	196
4. A 2-connected 2-covering space	199
5. Vertical fundamental groupoid	213

Appendix A. Bicategories, bigroupoids and 2-groups	217
1. Bicategories	217
2. 2-groups	222
Bibliography	225

Abstract

This thesis introduces two main concepts: a *fundamental bigroupoid of a topological groupoid* and *2-covering spaces*, a categorification of covering spaces. The first is applied to the second to show, among other things, that the fundamental 2-group of the 2-covering space is a sub-2-group of the fundamental 2-group of the base. Along the way we derive general results about localisations of the 2-categories of categories and groupoids internal to a site at classes of weak equivalences, construct a topological fundamental bigroupoid of locally well-behaved spaces, and finish by providing a rich source of examples of 2-covering spaces, including a functorial 2-connected 2-covering space.

Statement of originality

This thesis contains no material which has been accepted for the award of any other degree or diploma at any other university or other tertiary institution to me and, to the best of my knowledge and belief, contains no material previously published or written by another person, except where due reference has been made in the text.

I give consent to this copy of my thesis, when deposited in the University Library, being made available for loan and photocopying, subject to the provisions of the Copyright Act 1968.

I also give permission for the digital verions of my thesis to be made available on the web, via the University's digital research repository, the Library catalogue, the Australasian Digital Theses Program (ADTP) and also through web search engines.

David Michael Roberts
Adelaide, South Australia
December 2009

Acknowledgements

I must first thank my principal supervisor, Michael Murray, for his patience and for trusting me to pretty much direct my own research. I also thank my supervisor Mathai Varghese for imparting to this one-time physicist a sense of thoroughness and mathematical rigor. His emphasis on the need for existence of nontrivial examples was a major motivation for this thesis. Mathai also helped organise a visit to the Erwin Schrödinger Institute in Vienna which gave me the opportunity to meet my now coauthor Urs Schreiber. The visit to ESI was jointly funded by the Institute and a Cathy Candler Award from AFUW-SA. I must also thank Jim Stasheff for agreeing to join my supervisory panel late in my degree – it was a step into the unknown to ask him and a most pleasant surprise to hear a ‘yes’. Nick Buchdahl, while his time as a supervisor was only a few months at the start of my candidature, always helped me when I turned up with bewildered questions, for which I say *merci*.

The postgraduate students in the School of Mathematical Sciences have formed a wonderful group of friends, and special thanks are due to David Butler and Jono Tuke for being there from the beginning. These two, together with Richard Green, Rongmin Lu, Ryan Mickler, Tyson Ritter and Raymond Vozzo, provided not only listeners to whom I could pour out my sometimes obscure theories, but welcome distractions and opportunities to learn things I would otherwise never have considered. The hosts of the n -category café have also provided a wonderful environment for the reading and discussion of many fascinating topics.

I greatly appreciate help with proofreading and suggestions for improvements from Richard Green, Rongmin Lu, Michael Murray, Tyson Ritter, Jim Stasheff and Raymond Vozzo. During the first four and a half years of my candidature I was supported by an Australian Postgraduate Award, and I am also grateful for study leave from my employer, the National Centre for Vocational Education Research, during the final stages of the writing up of this thesis.

Lastly, I would like to thank my mother, Shirley Woodhouse, for her constant patience and support throughout my entire time at university, and my fiancée, Dani-Marie Breen, for joining me on my journey, and filling it with many wonderful moments.

Introduction

The theory of covering spaces is an indispensable tool in the toolboxes of algebraic and differential topologists. Covering spaces were historically the first examples of fibre bundles and principal bundles. They also make an appearance as locally constant sheaves and, when the fibres have a group structure, are used in cohomology as systems of local coefficients. Geometric constructions requiring a vanishing fundamental group can often be realised by passing to a simply-connected covering space.

Whereas covering spaces are intrinsically linked with the homotopy 1-type of a space, there does not as yet exist an analogous topological structure for the 2-type. Our aim is to describe objects, dubbed *2-covering spaces*, that fulfill this rôle, and also provide some tools with which to study them. The fibres of covering spaces are sets, which are 0-types, so it is natural to use ‘bundles’, locally trivial after some fashion, where the fibres are 1-types. Just as covering spaces are not just bundles where the fibres consist of a disjoint union of contractible spaces (which are also 0-types), it is also justifiable to use the ‘most discrete’ representatives of 1-types. For this purpose we use the well-known equivalence

$$\text{groupoids} \leftrightarrow \text{1-types}$$

so that the fibres of 2-covering spaces are groupoids.

Before we can study 2-covering spaces in detail, a number of concepts and ideas from (algebraic) topology need to be reinvented; paths, homotopies, homotopy groups and lifting of functions all have to be generalised to work in this new setting.

◦

A crucial idea here is *categorification*, a process of taking a category of interesting objects and replacing sets in the definition(s) of said objects by categories or groupoids. Because of the presence of natural transformations (i.e. 2-arrows in **Cat**), one can, and does, weaken equalities of objects and arrows to isomorphisms. These isomorphisms then need to satisfy axioms of their own. A historical example is the introduction of homology groups by E. Noether and Vietoris to replace the Betti and torsion numbers. An equality of Betti numbers became an isomorphism of free abelian groups and so on.

In recent years there has been great interest in extending categorification from algebraic structures, such as groups [Sin75, JS86, BL04], vector spaces [KV94,

Bae97], tangles [**BL03**], monoidal categories [**BN96**] etc., to geometric and topological structures, such as homogeneous geometry [**nLa**] and bundles [**Bar06**, **BS07**], principal and otherwise. It should be said that before the categorification program was explicitly described in [**BD95**], one of the earliest examples were stacks, defined in the 1960s by Grothendieck and his school [**Gir71**, **Gro71**]. In that case, functors¹ $\mathcal{O}(X)^{op} \rightarrow \mathbf{Set}$ are replaced by weak 2-functors $\mathcal{O}(X)^{op} \rightarrow \mathbf{Gpd}$. In particular, gerbes, which are a specialisation of stacks, have enjoyed a steady revival since the 1990s most likely due to the treatment of the differential geometry of abelian gerbes by Brylinski [**Bry93**] and applications to twisted K-theory starting with [**BCM⁺02**].

Great progress is being made of late in the study of topological stacks [**Noo05**], their homotopy type in the broad sense [**Noo08b**, **Ebe09**] and covering stacks (i.e. the analogues of covering spaces) [**Noo08a**]. However, there is no theory that deals with what one might think is a natural generalisation of covering spaces, where the fibre is bumped up a categorical dimension, not just the base and total ‘spaces’. One reason for this may be that when one works with a covering stack, it is locally (that is, pulled back to a stack that is a space) a covering space, which is a well-understood situation.

Although recent interest in categorified bundles (called in various places 2-bundles [**Bar06**, **BS07**], 2-torsors [**Bak07**] and categorical torsors [**CG01**]) has been directed by category theoretic considerations or by interest in possible applications to string theory [**Sch05**], not much attention has been paid to what one might call the phenomenology of 2-bundles. That is, there is a paucity of examples which can be used as test cases for constructing calculational techniques or hypothesis forming.

◦

The aim of this thesis is to begin to fill this gap with 2-covering spaces. The ‘total space’ of a 2-covering space is necessarily a topological groupoid, a groupoid where the collections of objects and arrows are not just sets but topological spaces and the various maps relating them (source, target, etc.) are all continuous [**Ehr59**].² Groupoids in the usual sense are then topological groupoids equipped with the discrete topology on the sets of objects and arrows, and to distinguish these from topological groupoids these shall be called *topologically discrete groupoids*. By the general principles of category theory we cannot demand that the fibres of 2-covering spaces *are* topologically discrete groupoids, only that they are topological groupoids that are *equivalent* to topologically discrete groupoids.

This raises the question of what sort of 2-category of topological groupoids we need to use. General results of Ehresmann [**Ehr63**] tell us that there is a 2-category

¹The category $\mathcal{O}(X)$ has as objects the open sets of the space X and inclusions as arrows. As such it defines a 2-category with only identity 2-arrows.

²This is to be contrasted with the convention of calling **Top**-enriched categories/groupoids ‘topological categories/groupoids’. We also distinguish what we have here from those categories which are called ‘topological’ because they have a forgetful functor to **Set** with a number of adjoints analogous to the case of **Top** \rightarrow **Set**.

TG of topological groupoids, functors and natural transformations, where the data of the last two necessarily consist of continuous maps. However, this 2-category does not have enough equivalences, in that there are fully faithful, essentially surjective functors with no pseudoinverse. This is because the internal axiom of choice does not hold in **Top** — not every surjection has a section. Another reason to consider such a map as an equivalence is that it induces an equivalence between the respective categories of modules (because of this, it is not uncommon to find references to Morita equivalences between Lie groupoids, e.g. [BX03] and other papers by Ping Xu).

To rectify this fact we need to be able to localise TG , adding the formal inverses of a class of 1-arrows and then enough structure so that we still end up with (at least) a bicategory. The theory necessary for this was worked out by Pronk [Pro96], with a view toward certain 2-categories of stacks (differentiable, algebraic and topological étale stacks). Various such localisations have appeared in the literature, for example [HS87, Pra89, Pro96, Lan01, MM05], whether they have been explicitly stated or not, but there was lacking a general result for the 2-category $\mathbf{Gpd}(S)$ of *internal* groupoids – groupoids such that the defining diagrams are interpreted in an arbitrary finitely complete category S (such as **Top**, **Grp**, **Vect** and so on).

To do this we require S to have the structure of a (subcanonical) site, a category equipped with a notion of ‘covering family’ called a *Grothendieck pretopology*. Given a pretopology we have a class of arrows which replace surjections, namely maps admitting local sections over some covering family. One reason for not using epimorphisms for this purpose is that they are not always surjective (when this makes sense), such as in **Ring**. If J is a pretopology, call a functor between categories in S *essentially J -surjective* if the map that usually expresses essential surjectivity admits sections over a covering family from J . A functor is then a J -equivalence if it is fully faithful and essentially J -surjective (this notion appears in [BP79] for J the canonical pretopology and in [EKvdL05] for more general classes of maps). Denote by W_J the class of J -equivalences in both $\mathbf{Cat}(S)$ and $\mathbf{Gpd}(S)$. Then we have:

THEOREM 0.1. *Let (S, J) be a site with a subcanonical pretopology J . The 2-categories $\mathbf{Cat}(S)$, $\mathbf{Gpd}(S)$ admit bicategories of fractions for W_J .*

Given a site where the covering families consist of single maps (there are many examples involving **Top**, the prime example being $\mathbf{II}\mathcal{O}$, the class of maps of the form $\coprod_{\alpha} U_{\alpha} \rightarrow X$ derived from an open cover $\{U_{\alpha}\}$ of X), we can construct a model $\mathbf{Ana}(S, J)$ of the localisation simpler than the canonical model given in [Pro96]. The 1-arrows of this bicategory, denoted \dashrightarrow , are called *anafunctors*, originally introduced in [Mak96] for ordinary categories, and formulated internal to a site in [Bar06]. The fact that $\mathbf{Ana}(S, J)$ is a localisation has not appeared before, and its utility lies in its ‘tuneability’ – localisation of a 2-category is only defined up to equivalence of bicategories and so one can choose the most convenient class of covers with which to work. To give a glimpse of one aspect of anafunctors, the hom-groupoid $\mathbf{Ana}(\mathbf{Top}, \mathbf{II}\mathcal{O})(X, \mathbf{BG})$ where X is a space – a groupoid with no

non-identity arrows – and \mathbf{BG} is a one-object topological groupoid – a topological group – has objects that are exactly Čech cocycles on X , and the arrows are coboundaries.

◦

We place ourselves now firmly in the bicategory \mathbf{Ana} of topological groupoids, anafunctors (defined using \mathbf{IO}) and transformations between them as the universe of discourse. The 2-category TG is a (strict) sub-bicategory, so any constructions in TG can be considered as taking place in \mathbf{Ana} . Topological groupoids obviously contain a lot of homotopical information, coming from both the topology and the groupoid structure. The one-dimensional homotopy of a topological groupoid is captured by the fundamental group(oid), defined in various places for special cases; Haefliger defined this for *foliation* groupoids [Hae71, Hae90], Moerdijk and Mrčun [MM03], and Colman [Col06] for *Lie* groupoids, Schreiber and Waldorf for *Čech* groupoids [SW09]. These methods essentially use the fact that arrows of the topological groupoid³ should be treated on an equal footing with the paths in the object space of the groupoid. Arrows of the fundamental groupoid are thus formal composites of these. This can be generalised by realising that n -dimensional cubes in the object space and $(n - 1)$ -dimensional cubes in the arrow space should be treated on equal footing. In fact one can use this idea to discuss homotopy in each dimension, but in this thesis we stop at $n = 2$, so as to cover only as much as is necessary for our study of 2-covering spaces.

As such we define (after some effort!) a functor

$$\Pi_2: TG_0 \rightarrow \mathbf{Bigpd}$$

sending a topological category to its fundamental bigroupoid (here \mathbf{Bigpd} denotes the 1-category of bigroupoids and strict 2-functors). This functor sends weak equivalences (functors sent to equivalences by $TG \rightarrow \mathbf{Ana}$) to equivalences of bigroupoids. That the definition of Π_2 given is the correct one is supported by the computational result that for a topological group G there is an equivalence of bigroupoids

$$\Pi_2^T(BG) \rightarrow \Pi_2(\mathbf{BG})$$

where Π_2^T is the usual fundamental bigroupoid of the topological space BG , and \mathbf{BG} is the one-object groupoid determined by G . We also show that Π_2 agrees on spaces, up to equivalence, with the definition of the fundamental bigroupoid of a space given in [Ste00, HKK01].

◦

Now a 2-covering space is a groupoid Z equipped with a functor π to a space X , such that there is an open cover $\{U_\alpha\}$ of X and for each U_α an equivalence

$$U_\alpha \times D_\alpha \xrightarrow{\sim} Z \times_X U_\alpha$$

³We shall assume all groupoids are topological from now on, unless otherwise specified.

over U_α in the bicategory \mathbf{Ana} , where D_α is a topologically discrete groupoid. This definition is natural and desirable: it is a simple categorification of the unadorned definition of a bundle and the fibres are particularly uncomplicated. Notice that the open cover, the equivalences and the groupoids D_α are not part of the data of the 2-covering space – they are only required to exist. To contrast, the authoritative work on 2-bundles by Toby Bartels [Bar06] takes a more complete view of things, defining a 2-bundle to consist of a groupoid over a base, a typical fibre, a trivialisation and a structure 2-group, such that a number of coherence diagrams (2-)commute. Even with such a stripped back definition, we are able to derive results that are analogues of the usual results for covering spaces. For a start, if we assume the base space is path-connected, all the fibres (which are equivalent to topologically discrete groupoids) are equivalent. We can thus talk about ‘the’ fibre of a 2-covering space, or at least a given representative that is equivalent to all of the fibres.

One remark that should be made is that much, if not all, of the theory of 2-covering spaces considered also works in the smooth setting. There is an analogue ofanafunctors for Lie groupoids, the localisation result holds, and the definition of 2-covering space clearly makes sense for Lie groupoids. Whether one considers manifolds in the traditional sense or some sort of *smooth space* e.g. [BH10] (where the constructions here go over verbatim) is much a matter of choice. It should be remarked that manifolds in this instance will need to be Fréchet manifolds [Ham82] in general, as many of the examples, at least in this thesis, involve path spaces.

The bicategory of 2-covering spaces is defined to be the full sub-bicategory of \mathbf{Ana}/X with objects the 2-covering spaces. As with covering spaces, we can also talk about pointed 2-covering spaces – these are simply covering spaces with a chosen object in the fibre over the basepoint of the base space. The category of pointed, path-connected covering spaces of a pointed, path-connected space is particularly simple in that it forms a poset. We find a similar result for pointed 2-covering spaces, that the bicategory of pointed 2-covering spaces of a pointed, path-connected space has posets for hom-categories (actually hom-groupoids).

◦

A major result for the general theory of 2-covering spaces is the following.

THEOREM 0.2. *Let $Z \rightarrow X$ be a 2-covering space. The induced 2-functor $\Pi_2(Z) \rightarrow \Pi_2(X)$ is locally faithful.*

Given an object $z \in Z$ we can talk about the homomorphism of 2-groups

$$\Pi_2(Z)(z, z) \rightarrow \Pi_2(X)(\pi(z), \pi(z)).$$

For covering spaces one knows that the fundamental group of the total space is a subgroup of the fundamental group of the base, with the inclusion homomorphism induced by the projection map. The analogue of a subgroup for 2-groups is a faithful functor, that is, injective on hom-sets. The above theorem tells us that the homomorphism of fundamental 2-groups induced by the projection functor of a 2-covering space is faithful. This further implies that if we consider just the second

homotopy group, which is encoded in the fundamental 2-group, the projection map induces the inclusion of a subgroup $\pi_2(Z) \hookrightarrow \pi_2(X)$.

Aside from this analogy with covering spaces, the whole structure encoded by the 2-functor $\Pi_2(Z) \rightarrow \Pi_2(X)$ should give information on what should be meant by a fibration of bigroupoids. Some approaches to this exist [Her99, HKK02], but take a very different viewpoint to even what little is considered here. While lifting of 1-arrows in the two cited approaches can be specified much as lifting of paths in a Serre or Hurewicz fibration, lifting of 1-arrows in our approach can only be specified along the lines of a Dold fibration [Dol63]. These are characterised by homotopy lifting where the specified initial condition only agrees with the lifted initial condition up to a vertical homotopy. This is, to the author's mind, a more bicategorical approach to lifting, but we do not develop this theme here.

This algebraic notion of fibration encoded in fundamental bigroupoids, the one-dimensional analogue of which appears in the work of Ronnie Brown [Bro70, Bro06], only contains homotopical information at dimension two and lower. Given the fact fibre bundles are examples of fibrations, one would think there is a categorification of the concept of fibration that goes along with 2-bundles, defined using lifting of homotopies (of cubes, say) in an appropriately weak sense. The definition of 2-covering space is quite amenable to calculations in this mode, but again space does not permit further speculation along this line.

One of the most well-known objects that correspond to 2-bundles are bundle gerbes [Mur96], originally introduced in the smooth setting with (what we would now call) structure 2-group \mathbf{BC}^\times . However, we can replace \mathbb{C}^\times with any abelian (topological) group A and consider bundle A -gerbes over a topological space. A particular class of bundle gerbes called *lifting* bundle A -gerbes for discrete groups A are easily shown to be 2-covering spaces with fibre a transitive groupoid. Every bundle gerbe is stably isomorphic to a lifting bundle gerbe, but this fact is not used in the present work. On the other hand, not all 2-covering spaces Z have fibres that are transitive, but there is always a space Z_0/Z_1 , the space of isomorphism classes of objects, over which the 2-covering space has transitive fibres. We can then, by borrowing a generalisation of the definition of bundle gerbe from [LGSX09] (there called *groupoid G -extensions*), arrive at the following result.

THEOREM 0.3. *If $p: Z \rightarrow X$ is a 2-covering space, then p factorises as*

$$Z \rightarrow Z_0/Z_1 \rightarrow X$$

where $Z \rightarrow Z_0/Z_1$ is a bundle gerbe, and $Z_0/Z_1 \rightarrow X$ is a covering space.

◦

One of the original motivations for the present thesis was to construct a functorial 2-connected ‘cover’ of a (sufficiently nice) space. A non-functorial construction was given in the paper [Whi52], where the existence of n -connected covers was proved for all $n \geq 0$. By general categorical considerations, one can construct such a space functorially using the adjunction between simplicial sets and topological spaces, and the existence of a functorial 2-connected cover in $s\mathbf{Set}$. However, this construction

is very large (infinite dimensional, comparable in size to the geometric realisation of the singular complex $S(X)$), and certainly not suitable for considering in the category of manifolds. The construction of the universal covering space of a locally nice space follows very quickly once one has a topology on the fundamental groupoid.

To this end we describe, under a condition on the space X , called here *2-well-connectedness*, which is always satisfied whenever X is a CW-complex, a topology on the fundamental bigroupoid $\Pi_2(X)$ such that all the maps involved in the definition are continuous.⁴ Let $\mathbf{Top}_{2wc,*}$ be the full subcategory of \mathbf{Top}_* consisting of the 2-well-connected pointed spaces. If TG_0 denotes the 1-category underlying TG , let TG_0/\mathbf{Top} be the full subcategory of TG_0^2 with objects the functors with codomain a space. We then prove:

THEOREM 0.4. *There is a functor*

$$\begin{aligned} \mathbf{Top}_{2wc,*} &\rightarrow TG_0/\mathbf{Top} \\ (X, x) &\mapsto (X^{(2)} \rightarrow X) \end{aligned}$$

where $X^{(2)}$ is a 2-connected topological groupoid, and if X is locally contractible, $X^{(2)} \rightarrow X$ is a 2-covering space.

Given the objection above to the infinite dimensionality of the ‘other’ functorial 2-connected cover, it should be noted here that this topological groupoid also consists of infinite dimensional spaces, but the object space is the based path space $P_x X$, a rather smaller space than $|S(X)|$. The path space can also be quite easily made into a smooth (Fréchet) manifold whenever X is a smooth manifold. In particular, when $X = \Omega G$ for a compact Lie group G the groupoid $(\Omega G)^{(2)}$ should be directly related to the level 1 central extension $\widehat{\Omega G}$ (e.g. [MS03], but several constructions exist, for which see the references of *ibid.*) which is a Fréchet Lie group, but more importantly, is 2-connected (this fact can easily be established, but does not seem to appear in the literature anywhere).

It should be noted that we do not treat any homotopy groups higher than π_2 here, but it is expected that we have isomorphisms induced on higher homotopy groups, as the fibre, being equivalent to a topologically discrete groupoid, has vanishing homotopy above dimension 1 [Rob].

Just before this thesis was finished, the preprint [Noo09] was released, dealing in part with the 2-connected cover of a Lie 2-group.

Another example of a 2-covering space is the vertical fundamental groupoid $\Pi_1^{\mathcal{Y}}(E)$ of a locally trivial bundle $p: E \rightarrow X$. This is essentially the gluing together of the topologised fundamental groupoids of each fibre of the bundle. The reader is invited to compare this notion with the fundamental groupoid *à la* Grothendieck of a scheme over a base scheme (a flat family of curves, for example). In this instance one does not have an equivalent bundle of groups – a group object in the category of covering spaces – unless the map p has a section. It would be interesting to see

⁴Using the theory of infinite dimensional manifolds, this can be extended to the structure of a Fréchet-Lie bigroupoid [RS].

what interaction this construction has, if any, with the idea of the moduli space of curves.

Finally, there is the link with stacks, which is not touched on in the present work, except implicitly. The well-known equivalence between sheaves on a space X and étale maps $Y \rightarrow X$ restricts to an equivalence between covering spaces of X and *locally constant* sheaves. In letters to Breen in 1975 [Gro75], Grothendieck mused on the relationship between homotopy n -types, n -groupoids, locally constant $(n - 1)$ -stacks and cohomology. He would later go on to develop some of these ideas further in the more famous manuscript *Pursuing stacks*. The theory envisaged by Grothendieck has been realised for locally constant (1-)stacks in [PW05], relating them to monodromy 2-functors. This thesis can be considered as introducing the ‘missing partner’ of locally constant stacks, namely 2-covering spaces.

◦

An outline of the thesis is as follows.

- Chapter 1 We sketch the well-known theory of internal categories and groupoids, and recall the material on internal anafunctors from [Bar06] and the localisation framework of [Pro96]. We put all these together to prove the existence of the bicategory of fractions of the 2-categories $\mathbf{Cat}(S)$ of categories and $\mathbf{Gpd}(S)$ of groupoids internal to a subcanonical, superextensive, finitely complete site S . We also show equivalent Grothendieck pretopologies define anafunctors which then give equivalent localisations.
- Chapter 2 This chapter deals with defining the fundamental bigroupoid of a topological groupoid. This process requires a fair amount of supporting material, as simple notions such as paths and homotopies need developing from scratch. Once the functor $\Pi_2: TG \rightarrow \mathbf{Bigpd}$ is defined, the rest of the chapter is devoted to calculations which support the claim this gives the correct homotopy 2-type.
- Chapter 3 In this very short chapter we rederive the localisation results from chapter 1 in the specific case of *pointed* topological groupoids. So as not to overburden the reader, only the necessary additional steps in proofs are supplied. We define pointed anafunctors and transformations and show the bicategory of pointed topological groupoids, pointed anafunctors and pointed transformations is a localisation of the 2-category of pointed topological groupoids, weakly pointed functors and pointed transformations.
- Chapter 4 We arrive at the main object of the thesis in this chapter, viz. 2-covering spaces. After a little background material on covering spaces, we recast some of these facts in terms using topological groupoids. We then define 2-covering spaces and prove various results about the structure of 2-covering spaces. We then cover some elementary lifting properties and show that the induced map on fundamental bigroupoids is locally faithful. The chapter concludes with a discussion of the relationship between bundle gerbes and 2-covering spaces.

- Chapter 5 This chapter is devoted entirely to two main examples of 2-covering spaces, namely the canonical 2-connected 2-covering space and the vertical fundamental groupoid of a locally trivial bundle. Along the way we describe a topology on the fundamental bigroupoid of a locally nice space and conditions on a transitive topological bigroupoid such that its source fibres are 2-covering spaces.
- Appendix A We provide some background on bicategories, bigroupoids, 2-functors and 2-groups.

Internal categories and anafunctors

In this chapter we consider anafunctors [Mak96, Bar06] as generalised maps between internal categories [Ehr63], and show they formally invert fully faithful, essentially surjective functors (this localisation was developed in [Pro96] without anafunctors). To do so we need our ambient category S to be a site, to furnish us with a class of arrows that replaces the class of surjections in the case $S = \mathbf{Set}$. The site comes with collections called covering families, or covers, and give meaning to the phrase “essentially surjective” when working internal to S . A useful analogy to consider is when S is \mathbf{Top} , and the covering families are open covers in the usual way. In that setting, ‘surjective’ is replaced by ‘admits local sections’, and the same is true for an arbitrary site – surjections are replaced by maps admitting local sections with respect to the given class of covers. The class of such maps does not determine the covers with which one started, and we use this to our advantage. A *superextensive* site¹ is a one where out of each covering family $(U_i \rightarrow A)_{i \in I}$ we can form a single map $\coprod_I U_i \rightarrow A$, and use these as our covers. A map admits local sections over the original covering family if and only if it admits sections over the new cover, and it is with these we can define anafunctors. Finally we show that different collections of covers will give equivalent results if they give rise to the same collection of maps admitting local sections.

Most of the definitions in this chapter are standard. We draw without reference on the background to bicategories collected in Appendix A. The material on anafunctors and localising bicategories, although not new, does not seem to be widely known. Theorem 1.89 is new, but we note analogues have appeared in the literature for foliation groupoids [HS87], Lie groupoids, e.g. [Lan01, MM05], and étale Lie groupoids [Pro96] (neither of which are covered by this chapter), and for étale topological groupoids and algebraic groupoids (étale groupoids internal to schemes) [Pro96]. Theorem 1.92 and its corollaries are also new.

1. Internal categories and groupoids

Internal categories were introduced by Ehresmann [Ehr63], starting with differentiable and topological categories (i.e. internal to \mathbf{Diff} and \mathbf{Top} respectively). We collect here the necessary definitions and terminology without burdening the reader with pages of diagrams. For a thorough recent account, see [BL04] or [Bar06]. Familiarity with basic category theory [Mac71] is assumed.

Let S be a category with binary products and pullbacks. It will be referred to as the *ambient category*.

¹This concept is due to Toby Bartels and Mike Shulman

DEFINITION 1.1. An *internal category* X in a category S is a diagram

$$X_1 \times_{X_0} X_1 \xrightarrow{m} X_1 \xrightleftharpoons{s,t} X_0 \xrightarrow{e} X_1$$

in S such that the *multiplication* m is associative, the *unit map* e is a two-sided unit for m and s and t are the usual *source* and *target*.

The pullback in the diagram is

$$\begin{array}{ccc} X_1 \times_{X_0} X_1 & \longrightarrow & X_1 \\ \downarrow & & \downarrow s \\ X_1 & \xrightarrow{t} & X_0. \end{array}$$

This, and pullbacks like this (where source is pulled back along target), will occur often. If confusion can arise, the maps in question will be noted down, as in $X_1 \times_{s,X_0,t} X_1$. Also, since multiplication is associative, there is a well-defined map $X_1 \times_{X_0} X_1 \rightarrow X_1$, which will also be denoted by m .

It follows from the definition² that there is a subobject $X_1^{iso} \hookrightarrow X_1$ through which e factors and an involution

$$(-)^{-1}: X_1^{iso} \rightarrow X_1^{iso}$$

sending arrows to their inverses such that the restriction of the structure maps to X_1^{iso} make $X_1^{iso} \rightrightarrows X_0$ an internal category, and that $(-)^{-1} \circ e = e$.

Often an internal category will be denoted $X_1 \rightrightarrows X_0$, the arrows m, s, t, e will be referred to as *structure maps* and X_1 and X_0 called the object of arrows and the object of objects respectively. For example, if $S = \mathbf{Top}$, we have the space of arrows and the space of objects, for $S = \mathbf{Grp}$ we have the group of arrows and so on.

REMARK 1.2. A very often used class of internal categories is that of Lie groupoids (e.g. [Mac05]). Since \mathbf{Diff} does not have all pullbacks, modifications need to be made to the above definition. Since submersions admit pullbacks and are stable, s and t are assumed to be surjective submersions. Various other constructions involving pullbacks later on in this chapter also need care, and there is an established literature on the subject. More generally, one can consider internal category theory for ambient categories without pullbacks, given a class of maps analogous to submersions, but we will not do this in the present work.

EXAMPLE 1.3. If M is a monoid object in S and $a: M \times X \rightarrow X$ is a (left) action, there is a category $M \ltimes X \rightrightarrows X$, called the action category, where the source and target are projection and the action respectively. Likewise for a right action there is a category $X \rtimes M$. The subobject of invertible arrows of $M \ltimes X$ is $M^* \ltimes X$. In particular, consider the case when X is the terminal object (which we assume exists in this case so we can define the unit of the monoid). Then such a category is precisely a monoid.

²as shown in [BP79], but see [EKvdL05] for some more details.

EXAMPLE 1.4. If $X \rightarrow Y$ is an arrow in S admitting iterated kernel pairs, there is a category $\check{C}(X)$ with $\check{C}(X)_0 = X$, $\check{C}(X)_1 = X \times_Y X$, source and target are projection on first and second factor, and the multiplication is projecting out the middle factor in $X \times_Y X \times_Y X$. The subobject of invertible arrows is all of $\check{C}(X)_1$.

A lot of interest in internal categories is for defining stacks over the ambient category (once it has the structure of a site, for which see below), and specifically, stacks of groupoids. These lead to considering internal groupoids as local models for the stack over the site (e.g. [BP79] in the case of a regular, finitely complete category).

DEFINITION 1.5. If $X_1^{iso} \hookrightarrow X_1$ is an isomorphism for an internal category X , then X is called an *internal groupoid*.

A lot of the terminology and machinery will be described here for internal categories, even though most of the examples of interest are internal groupoids.

EXAMPLE 1.6. Let S be a category. For each object $A \in S$ there is an internal groupoid $\text{disc}(A)$ which has $\text{disc}(A)_1 = \text{disc}(A)_0 = A$ and all structure maps equal to id_A . Such a category is called *discrete*. Clearly we have $\text{disc}(A \times B) = \text{disc}(A) \times \text{disc}(B)$.

If S has binary products, there is an internal groupoid $\text{codisc}(A)$ with $\text{codisc}(A)_0 = A$, $\text{codisc}(A)_1 = A \times A$ and where source and target are projections on the first and second factor respectively. The unit map is the diagonal and composition is projecting out the middle factor in $\text{codisc}(A)_1 \times_{\text{codisc}(A)_0} \text{codisc}(A)_1 = A \times A \times A$. Such a groupoid is called *codiscrete*. Again, we have $\text{codisc}(A \times B) = \text{codisc}(A) \times \text{codisc}(B)$.

EXAMPLE 1.7. The codiscrete groupoid is obviously a special case of example 1.4, which is called the Čech groupoid of the map $X \rightarrow Y$. The origin of the name is that in **Top**, for maps of the form $\coprod_I U_i \rightarrow Y$, the Čech groupoid $\check{C}(\coprod_I U_i)$ appears in the definition of Čech cohomology.

EXAMPLE 1.8. If G is a group object in a category S with finite products, the groupoid $\mathbf{B}G$ has $\mathbf{B}G_0 = *$, $\mathbf{B}G_1 = G$.

EXAMPLE 1.9. If C is a category with a set of objects enriched in **Top**, then let $C_0^{int} = \text{Obj}(C)$ and $C_1^{int} = \coprod_{\text{Obj}(C)^2} C(a, b)$. Then C^{int} is a category internal to **Top**. This example can be generalised to monoidal categories other than **Top** in which sufficient coproducts of the unit exist.

EXAMPLE 1.10. If X is a topological space which has a universal covering space (i.e. is path-connected, locally path-connected and semilocally simply connected), then the fundamental groupoid $\Pi_1(X)$ can be made into a groupoid internal to **Top**.

DEFINITION 1.11. Given internal categories X and Y in S , an *internal functor* $f : X \rightarrow Y$ is a pair of maps

$$f_0 : X_0 \rightarrow Y_0 \quad \text{and} \quad f_1 : X_1 \rightarrow Y_1$$

called the object and arrow component respectively. The map f_1 restricts to a map $f_1 : X_1^{iso} \rightarrow Y_1^{iso}$ and both components commute with all the structure maps.

EXAMPLE 1.12. Given a homomorphism ϕ between monoids or groups, there is a functor between the categories/groupoids in example 1.3. More generally, given an equivariant map between objects with an M -action, it gives rise to a functor between the associated action categories.

EXAMPLE 1.13. If $A \rightarrow B$ is a map in S , there are functors $\text{disc}(A) \rightarrow \text{disc}(B)$ and $\text{codisc}(A) \rightarrow \text{codisc}(B)$.

EXAMPLE 1.14. If $A \rightarrow C$ and $B \rightarrow C$ are maps admitting iterated kernel pairs, and $A \rightarrow B$ is a map over C , there is a functor $\check{C}(A) \rightarrow \check{C}(B)$.

EXAMPLE 1.15. A map $X \rightarrow Y$ in **Top** induces a functor $\Pi_1(X) \rightarrow \Pi_1(Y)$ (when these exist).

DEFINITION 1.16. Given internal categories X, Y and internal functors $f, g: X \rightarrow Y$, an *internal natural transformation* (or simply transformation)

$$a: f \Rightarrow g$$

is a map $a: X_0 \rightarrow Y_1$ such that $s \circ a = f_0$, $t \circ a = g_0$ and the following diagram commutes

$$\begin{array}{ccc} X_1 & \xrightarrow{(g_1, a \circ s)} & Y_1 \times_{Y_0} Y_1 \\ (a \circ t, f_1) \downarrow & & \downarrow m \\ Y_1 \times_{Y_0} Y_1 & \xrightarrow{m} & Y_1 \end{array}$$

expressing the naturality of a . If a factors through Y_1^{iso} , then it is called a *natural isomorphism*. Clearly there is no distinction between natural transformations and natural isomorphisms when Y is an internal groupoid.

We can reformulate the naturality diagram above in the case that a is a natural isomorphism. Denote by $-a$ the composite arrow

$$X_0 \xrightarrow{a} Y_1^{iso} \xrightarrow{(-)^{-1}} Y_1^{iso} \hookrightarrow Y_1.$$

Then the above diagram commuting is equivalent to this diagram commuting

$$(1) \quad \begin{array}{ccc} X_0 \times_{X_0} X_1 \times_{X_0} X_0 & \xrightarrow{-a \times f \times a} & Y_1 \times_{Y_0} Y_1 \times_{Y_0} Y_1 \\ \simeq \downarrow & & \downarrow m \\ X_1 & \xrightarrow{g} & Y_1 \end{array}$$

which we will use repeatedly.

EXAMPLE 1.17. Let $V_\rho, V_{\rho'}$ be the action groupoids associated to representations ρ, ρ' of G on V . They are given by functors from G to $GL(V)$ as described in example 1.12. A natural transformation between these functors is precisely an intertwiner.

EXAMPLE 1.18. If X is a groupoid in S , A is an object of S and $f, g: X \rightarrow \text{codisc}(A)$ are functors, there is a natural isomorphism $f \xrightarrow{\sim} g$.

Internal categories (resp. groupoids), functors and transformations form a 2-category $\mathbf{Cat}(S)$ (resp. $\mathbf{Gpd}(S)$) [Ehr63]. There is clearly a 2-functor $\mathbf{Gpd}(S) \rightarrow \mathbf{Cat}(S)$. Also, disc and codisc , described in examples 1.6 and 1.13 are 2-functors $S \rightarrow \mathbf{Gpd}(S)$, whose underlying functors are left and right adjoint to the functor

$$(-)_0: \mathbf{Gpd}_1(S) \rightarrow S, \quad (X_1 \rightrightarrows X_0) \mapsto X_0.$$

Here $\mathbf{Gpd}_1(S)$ is the category underlying the 2-category $\mathbf{Gpd}(S)$. Hence for an internal category X in S , there are functors $\text{disc}(X_0) \rightarrow X$ and $X \rightarrow \text{codisc}(X_0)$, the latter sending an arrow to the pair (source, target).

DEFINITION 1.19. An *internal* or *strong equivalence* of internal categories is an equivalence in this 2-category: an internal functor $f: X \rightarrow Y$ such that there is a functor $f': Y \rightarrow X$ and natural isomorphisms $f \circ f' \Rightarrow \text{id}_Y$, $f' \circ f \Rightarrow \text{id}_X$.

In all that follows, ‘category’ will mean ‘internal category in S ’ and similarly for ‘functor’ and ‘natural transformation/isomorphism’. We will not be considering here the effect a functor $S \rightarrow S'$ between ambient categories has on internal category theory.

2. Sites and covers

All the material in this section is standard. Even though we are assuming our ambient category has pullbacks, a lot of the definitions are made for more general categories.

DEFINITION 1.20. A *Grothendieck pretopology* (or simply *pretopology*) on a category S is a collection J of families

$$\{(U_i \rightarrow A)_{i \in I}\}$$

of morphisms for each object $A \in S$ satisfying the following properties

- (1) $(\text{id}: A \rightarrow A)$ is in J for every object A .
- (2) Given a map $B \rightarrow A$, for every $(U_i \rightarrow A)_{i \in I}$ in J the pullbacks $B \times_A A_i$ exist and $(B \times_A A_i \rightarrow B)_{i \in I}$ is in J .
- (3) For every $(U_i \rightarrow A)_{i \in I}$ in J and for a collection $(V_k^i \rightarrow U_i)_{k \in K_i}$ from J for each $i \in I$, the family of composites

$$(V_k^i \rightarrow A)_{k \in K_i, i \in I}$$

are in J .

Families in J are called *covering families*. A category S equipped with a pretopology is called a *site*, denoted (S, J) .

EXAMPLE 1.21. The basic example is the lattice of open sets of a topological space, seen as a category in the usual way, where a covering family of an open $U \subset X$ is an open cover of U by opens in X . This is to be contrasted with the pretopology \mathcal{O} on \mathbf{Top} , where the covering families of a space are just open covers of the whole space.

EXAMPLE 1.22. On \mathbf{Grp} the class of surjective homomorphisms form a pretopology.

EXAMPLE 1.23. On **Top** the class of numerable open covers (i.e. those that admit a subordinate partition of unity [Dol63]) form a pretopology. Much of traditional bundle theory is carried out using this site, for example, the Milnor classifying space classifies bundles which are locally trivial over numerable covers [Mil56, Dol63, tD66].

DEFINITION 1.24. Let (S, J) be a site. The pretopology J is called a *singleton pretopology* if every covering family consists of a single arrow $(U \rightarrow A)$. In this case a covering family is called a *cover*.

EXAMPLE 1.25. In **Top**, the classes of covering maps, local section admitting maps, surjective étale maps and open surjections are all examples of singleton pretopologies. The results of [Pro96] pertaining to topological groupoids were carried out using the site of open surjections.

DEFINITION 1.26. A covering family $(U_i \rightarrow A)_{i \in I}$ is called *effective* if A is the colimit of the following diagram: the objects are the U_i and the pullbacks $U_i \times_A U_j$, and the arrows are the projections

$$U_i \leftarrow U_i \times_A U_j \rightarrow U_j.$$

If the covering family consists of a single arrow $(U \rightarrow A)$, this is the same as saying $U \rightarrow A$ is a regular epimorphism.

DEFINITION 1.27. A site is called *subcanonical* if every covering family is effective.

EXAMPLE 1.28. On **Top**, the usual pretopology of opens, the pretopology of numerable covers and that of open surjections are subcanonical.

EXAMPLE 1.29. In a regular category, the regular epimorphisms form a subcanonical singleton pretopology.

In fact, the (pullback stable) regular epimorphisms in any category form the largest subcanonical singleton pretopology, so it has its own name³

DEFINITION 1.30. The *canonical singleton pretopology* R is the class of all regular epimorphisms which are pullback stable. It contains all the subcanonical singleton pretopologies.

REMARK 1.31. If $U \rightarrow A$ is an effective cover, a functor $\check{C}(U) \rightarrow \text{disc}(B)$ gives a unique arrow $A \rightarrow B$. This follows immediately from the fact A is the colimit of $\check{C}(U)$.

DEFINITION 1.32. A *finitary* (resp. *infinitary*) *extensive* category is a category with finite (resp. small) coproducts such that the following condition holds: let I

³of course, the nomenclature was decided the other way around - ‘subcanonical’ meaning ‘contained in the canonical pretopology.’

be a finite set (resp. any set), then, given a collection of commuting diagrams

$$\begin{array}{ccc} x_i & \longrightarrow & z \\ \downarrow & & \downarrow \\ a_i & \longrightarrow & \coprod_{i \in I} a_i, \end{array}$$

one for each $i \in I$, the squares are all pullbacks if and only if the collection $\{x_i \rightarrow z\}_I$ forms a coproduct diagram.

In such a category there is a strict initial object (i.e. given a map $A \rightarrow 0$, $A \simeq 0$).

EXAMPLE 1.33. **Top** is infinitary extensive.

EXAMPLE 1.34. **Ring**^{op} is finitary extensive.

In **Top** we can take an open cover $\{U_i\}_I$ of a space X and replace it with the single map $\coprod_I U_i \rightarrow X$, and work just as before using this new sort of cover, using the fact **Top** is extensive. The sort of sites that mimic this behaviour are called superextensive.

DEFINITION 1.35. (Bartels-Shulman) A *superextensive site* is an extensive category S equipped with a pretopology J containing the families

$$(U_i \rightarrow \coprod_I U_i)_{i \in I}$$

and such that all covering families are bounded. This means that for a finitely extensive site, the families are finite, and for an infinitary site, the families are small.

EXAMPLE 1.36. Given an extensive category S , the *extensive pretopology* has as covering families the bounded collections $(U_i \rightarrow \coprod_I U_i)_{i \in I}$. The pretopology on any superextensive site contains the extensive pretopology.

EXAMPLE 1.37. The category **Top** with its usual pretopology of open covers is a superextensive site.

Given a superextensive site, one can form the class $\coprod J$ of arrows $\coprod_I U_i \rightarrow A$.

PROPOSITION 1.38. *The class $\coprod J$ is a singleton pretopology, and is subcanonical if and only if J is.*

Proof. Since identity arrows are covers for J they are covers for $\coprod J$. The pullback of a $\coprod J$ -cover $\coprod_I U_i \rightarrow A$ along $B \rightarrow A$ is a $\coprod J$ -cover as coproducts and pullbacks commute by definition of an extensive category. Now for the third condition we use the fact that in an extensive category a map

$$f: B \rightarrow \coprod_I A_i$$

implies that $B \simeq \coprod_I B_i$ and $f = \coprod_i f_i$. Given $\coprod J$ -covers $\coprod_I U_i \rightarrow A$ and $\coprod_J V_j \rightarrow (\coprod_I U_i)$, we see that $\coprod_J V_j \simeq \coprod_I W_i$. By the previous point, the pullback

$$\coprod_I U_k \times_{\coprod_I U_{i'}} W_i$$

is a $\amalg J$ -cover of U_i , and hence $(U_k \times_{\amalg_I U_{i'}} W_i \rightarrow U_k)_{i \in I}$ is a J -covering family for each $k \in I$. Thus

$$(U_k \times_{\amalg_I U_{i'}} W_i \rightarrow A)_{i,k \in I}$$

is a J -covering family, and so

$$\coprod_J V_j \simeq \coprod_{k \in I} \left(\coprod_I U_k \times_{\amalg_I U_{i'}} W_i \right) \rightarrow A$$

is a $\amalg J$ -cover.

The map $\amalg_I U_i \rightarrow A$ is the coequaliser of $\amalg_{I \times I} U_i \times_A U_j \rightrightarrows \amalg_I U_i$ if and only if A is the colimit of the diagram in definition 1.26. Hence $(\amalg_I U_i \rightarrow A)$ is effective if and only if $(U_i \rightarrow A)_{i \in I}$ is effective \square

Notice that the original pretopology J is generated by the union of $\amalg J$ and the extensive pretopology.

DEFINITION 1.39. Let (S, J) be a site. An arrow $P \rightarrow A$ in S is a J -epimorphism (or simply J -epi) if there is a covering family $(U_i \rightarrow A)_{i \in I}$ and a lift

$$\begin{array}{ccc} & & P \\ & \nearrow & \downarrow \\ U_i & \longrightarrow & A \end{array}$$

for every $i \in I$. The class of J -epimorphisms will be denoted $(J\text{-epi})$.

This definition is equivalent to the definition in III.7.5 in [MM92]. The dotted maps in the above definition are called local sections, after the case of the usual open cover pretopology on **Top**. If the pretopology is left unnamed, we will refer to *local epimorphisms*.

One reason we are interested in superextensive sites is the following

LEMMA 1.40. *If (S, J) is a superextensive site, the class of J -epimorphisms is precisely the class of $\amalg J$ -epimorphisms.*

If S has all pullbacks then the class of J -epimorphisms form a pretopology. In fact they form a pretopology with an additional condition – it is *saturated*. The following is adapted from [BW84]:⁴

DEFINITION 1.41. A singleton pretopology K is *saturated* if whenever the composite $V \rightarrow U \rightarrow A$ is in K , then $U \rightarrow A$ is in K .

In fact only a slightly weaker condition on S is necessary for $(J\text{-epi})$ to be a pretopology.

EXAMPLE 1.42. Let (S, J) be a site. If pullbacks of J -epimorphisms exist then the collection $(J\text{-epi})$ of J -epimorphisms is a saturated pretopology.

⁴Note that in [BW84] what we are calling a Grothendieck *pretopology*, is called a Grothendieck *topology*.

There is a definition of ‘saturated’ for arbitrary pretopologies, but we will use only this one. Another way to pass from an arbitrary pretopology to a singleton one in a canonical way is this:

DEFINITION 1.43. The *singleton saturation* of a pretopology on an arbitrary category S is the largest class $J_{sat} \subset (J\text{-epi})$ of those J -epimorphisms which are pullback stable.

If J is a singleton pretopology, it is clear that $J \subset J_{sat}$. In fact J_{sat} contains all the covering families of J with only one element when J is any pretopology.

From lemma 1.40 we have

COROLLARY 1.44. *In a superextensive site (S, J) , the saturations of J and $\amalg J$ coincide.*

One class of extensive categories which are of particular interest is those that also have finite/small limits. These are called *lexextensive*. For example, **Top** is infinitary lexextensive, as is a Grothendieck topos. In contrast, a general topos is finitary lexextensive. In a lexextensive category

$$J_{sat} = (\amalg J)_{sat} = (J\text{-epi}).$$

Sometimes a pretopology J contains a smaller pretopology that still has enough covers to compute the same J -epis.

DEFINITION 1.45. If J and K are two singleton pretopologies with $J \subset K$, such that $K \subset J_{sat}$, then J is said to be *cofinal* in K , denoted $J \leq K$.

Clearly $J \leq J_{sat}$.

LEMMA 1.46. *If $J \leq K$, then $J_{sat} = K_{sat}$.*

3. Weak equivalences

For categories internal to **Set**, equivalences are precisely the fully faithful, essentially surjective functors. For internal categories, however, this is not the case. In addition, we need to make use of a pretopology to make the ‘surjective’ part of essentially surjective meaningful.

DEFINITION 1.47. [BP79, EKvdL05] An internal functor $f : X \rightarrow Y$ in a site (S, J) is called

(1) *fully faithful* if

$$\begin{array}{ccc} X_1 & \xrightarrow{f_1} & Y_1 \\ (s,t) \downarrow & & \downarrow (s,t) \\ X_0 \times X_0 & \xrightarrow{f_0 \times f_0} & Y_0 \times Y_0 \end{array}$$

is a pullback diagram

(2) *essentially J -surjective* if the arrow labelled \circledast is in $(J\text{-epi})$

$$\begin{array}{ccccc}
 & X_0 \times_{Y_0} & Y_1^{iso} & & \\
 & \swarrow & \downarrow & \searrow & \\
 X_0 & & Y_1^{iso} & & \\
 \downarrow f_0 & \swarrow s & & \searrow t & \\
 Y_0 & & & & Y_0
 \end{array}$$

(3) a *J -equivalence* if it is fully faithful and essentially J -surjective.

The class of J -equivalences will be denoted W_J , and if mention of J is suppressed, they will be called *weak equivalences*.

EXAMPLE 1.48. If $X \rightarrow Y$ is an internal equivalence, then it is a J -equivalence for all pretopologies J [EKvdL05]. In fact, if T denotes the trivial pretopology (only isomorphisms are covers) the T -equivalences are precisely the internal equivalences.

EXAMPLE 1.49. If J is a singleton pretopology, and $U \rightarrow A$ is a J -cover (or more generally, is in J_{sat}), $\check{C}(U) \rightarrow \text{disc}(A)$ is a J -equivalence.

EXAMPLE 1.50. If $f : X \rightarrow Y$ is a functor such that f_0 is in $(J\text{-epi})$, then f is essentially J -surjective.

A very important example of a J -equivalence requires a little set up. The strict pullback of internal categories

$$\begin{array}{ccc}
 X \times_Y Z & \longrightarrow & Z \\
 \downarrow & & \downarrow \\
 X & \longrightarrow & Y
 \end{array}$$

is the category with objects $X_0 \times_{Y_0} Z_0$, arrows $X_1 \times_{Y_1} Z_1$, and all structure maps given componentwise by those of X and Z .

DEFINITION 1.51. Let S be a category with binary products, X a category internal to S and $p : M \rightarrow X_0$ an arrow in S . Define the *induced category* $X[M]$ to be the strict pullback

$$(2) \quad \begin{array}{ccc}
 X[M] & \longrightarrow & X \\
 \downarrow & \lrcorner & \downarrow \\
 \text{codisc}(M) & \longrightarrow & \text{codisc}(X_0)
 \end{array}$$

with objects M and arrows $M^2 \times_{X_0^2} X_1$. The canonical functor in the top row has as object component p and is fully faithful.

It follows immediately from the definition that given maps $M \rightarrow X_0$, $N \rightarrow M$, there is a canonical isomorphism

$$(3) \quad X[M][N] \simeq X[N].$$

If we agree to follow the convention that $M \times_N N = M$ is the pullback along the identity arrow id_N , then $X[X_0] = X$. This also simplifies other results of this chapter, so will be adopted from now on. One consequence of this assumption is that the iterated fibre product

$$M \times_M M \times_M \dots \times_M M,$$

bracketed in any order, is equal to M . We cannot, however, equate two bracketings of a general iterated fibred product – they are only canonically isomorphic.

EXAMPLE 1.52. If $\check{C}(B)$ is the Čech groupoid associated to a map $j: B \rightarrow A$ in S , then $\text{disc}(A)[B] \simeq \check{C}(B)$. Of special interest is the case when j is a cover for some pretopology on S .

LEMMA 1.53. *If (S, J) is a site, X a category in S and $(U \rightarrow X_0)$ is a covering family, the functor $X[U] \rightarrow X$ is a J -equivalence.*

Proof. The object component of the canonical functor $X[U] \rightarrow X$ is $U \rightarrow X_0$ and since it is in J it is in J_{sat} . Hence $X[U] \rightarrow X$ is a J -equivalence. \square

LEMMA 1.54. *Let X be an internal category in S , and $M \rightarrow X_0, N \rightarrow X_0$ arrows in S . Then the following square is a strict pullback*

$$\begin{array}{ccc} X[M \times_{X_0} N] & \longrightarrow & X[N] \\ \downarrow & & \downarrow \\ X[M] & \longrightarrow & X \end{array}$$

Proof. Consider the following cube

$$\begin{array}{ccccc} X[M \times_{X_0} N] & \xrightarrow{\quad} & X[N] & & \\ \downarrow & \searrow & \downarrow & \searrow & \\ & X[M] & \xrightarrow{\quad} & X & \\ \downarrow & \downarrow & \downarrow & \downarrow & \\ \text{codisc}(M \times_{X_0} N) & \xrightarrow{\quad} & \text{codisc}(N) & & \\ & \downarrow & \searrow & \downarrow & \\ & \text{codisc}(M) & \xrightarrow{\quad} & \text{codisc}(X_0) & \end{array}$$

The bottom and sides are pullbacks, either by definition, or using (3), and so the top is a pullback. \square

Fully faithful functors are stable under pullback, much like monomorphisms are.

LEMMA 1.55. If $f: X \rightarrow Y$ is fully faithful, and $g: Z \rightarrow Y$ is any functor, \hat{f} in

$$\begin{array}{ccc} Z \times_Y X & \longrightarrow & X \\ \hat{f} \downarrow & & \downarrow f \\ Z & \xrightarrow{g} & Y \end{array}$$

is fully faithful.

Proof. The following chain of isomorphisms establishes the claim

$$\begin{aligned} (Z_0 \times_{Y_0} X_0)^2 \times_{Z_0^2} Z_1 &\simeq X_0^2 \times_{Y_0^2} Z_1 \\ &\simeq (X_0^2 \times_{Y_0^2} Y_1) \times_{Y_1} Z_1 \\ &\simeq X_1 \times_{Y_1} Z_1, \end{aligned}$$

the last following from the fact f is fully faithful. \square

4. Anafunctors

DEFINITION 1.56. [Mak96, Bar06] Let (S, J) be a site. An *anafunctor* in (S, J) from a category X to a category Y consists of a cover $(U \rightarrow X_0)$ and an internal functor

$$f: X[U] \rightarrow Y.$$

The anafunctor is a span in $Cat(S)$, and will be denoted

$$(U, f): X \dashrightarrow Y.$$

EXAMPLE 1.57. For an internal functor $f: X \rightarrow Y$ in the site (S, J) , define the anafunctor $(X_0, f): X \dashrightarrow Y$ as the following span

$$X \xleftarrow{=} X[X_0] \xrightarrow{f} Y.$$

We will blur the distinction between these two descriptions. If $f = id: X \rightarrow X$, then (X_0, id) will be denoted simply by id_X .

EXAMPLE 1.58. If $U \rightarrow A$ is a cover in (S, J) and G is a group object in S , an anafunctor $(U, g): \text{disc}(A) \dashrightarrow \mathbf{BG}$ is a Čech cocycle.

DEFINITION 1.59. [Mak96, Bar06] Let (S, J) be a site and let

$$(U, f), (V, g): X \dashrightarrow Y$$

be anafunctors in S . A *transformation*

$$\alpha: (U, f) \rightarrow (V, g)$$

from (U, f) to (V, g) is an internal natural transformation

$$\begin{array}{ccc}
 & X[U \times_{X_0} V] & \\
 & \swarrow \quad \searrow & \\
 X[U] & \xRightarrow{\alpha} & X[V] \\
 & \swarrow \quad \searrow & \\
 & Y &
 \end{array}$$

(Note: The arrows from $X[U]$ and $X[V]$ to Y are labeled f and g respectively.)

If $\alpha: U \times_{X_0} V \rightarrow Y_1$ factors through Y_1^{iso} , then α is called an *isotransformation*. In that case we say (U, f) is *isomorphic to* (V, g) . Clearly all transformations between anafunctors between internal groupoids are isotransformations.

EXAMPLE 1.60. Given functors $f, g: X \rightarrow Y$ between categories in S , and a natural transformation $a: f \Rightarrow g$, there is a transformation $a: (X_0, f) \Rightarrow (X_0, g)$ of anafunctors, given by $X_0 \times_{X_0} X_0 = X_0 \xrightarrow{a} Y_1$.

EXAMPLE 1.61. If $(U, g), (V, h): \text{disc}(A) \dashrightarrow \mathbf{BG}$ are two Čech cocycles, a transformation between them is a coboundary on the cover $U \times_A V \rightarrow A$.

EXAMPLE 1.62. Let $(U, f): X \dashrightarrow Y$ be an anafunctor in S . There is an isotransformation $1_{(U, f)}: (U, f) \Rightarrow (U, f)$ called the *identity transformation*, given by the natural transformation with component

$$(4) \quad U \times_{X_0} U \simeq (U \times U) \times_{X_0^2} X_0 \xrightarrow{id_U^2 \times e} X[U]_1 \xrightarrow{f_1} Y_1$$

EXAMPLE 1.63. [Mak96] Given anafunctors $(U, f): X \rightarrow Y$ and $(V, f \circ k): X \rightarrow Y$ where $k: V \simeq U$ is an isomorphism over X_0 , a *renaming transformation*

$$(U, f) \Rightarrow (V, f \circ k)$$

is an isotransformation with component

$$1_{(U, f)} \circ (k \times \text{id}) : V \times_{X_0} U \rightarrow U \times_{X_0} U \rightarrow Y_1.$$

The isomorphism k will be referred to as a *renaming isomorphism*.

More generally, we could let $k: V \rightarrow U$ be any refinement, and this prescription also gives an isotransformation $(U, f) \Rightarrow (V, f \circ k)$.

EXAMPLE 1.64. As a concrete and relevant example of a renaming transformation we can consider the triple composition of anafunctors

$$\begin{aligned}
 (U, f): X &\dashrightarrow Y, \\
 (V, g): Y &\dashrightarrow Z, \\
 (W, h): Z &\dashrightarrow A.
 \end{aligned}$$

The two possibilities of composing these are

$$((U \times_{Y_0} V) \times_{Z_0} W, h \circ (gf^V)^W), \quad (U \times_{Y_0} (V \times_{Z_0} W), h \circ g^W \circ f^{V \times_{Z_0} W})$$

The unique isomorphism $(U \times_{Y_0} V) \times_{Z_0} W \simeq U \times_{Y_0} (V \times_{Z_0} W)$ commuting with the various projections is then the required renaming isomorphism. The isotransformation arising from this renaming transformation is called the *associator*.

We define the composition of anafunctors as follows. Let

$$(U, f): X \dashrightarrow Y \quad \text{and} \quad (V, g): Y \dashrightarrow Z$$

be anafunctors in the site (S, J) . Their composite $(V, g) \circ (U, f)$ is the composite span defined in the usual way.

$$\begin{array}{ccccc}
 & & X[U \times_{Y_0} V] & & \\
 & \swarrow & & \searrow & \\
 & X[U] & & Y[V] & \\
 \swarrow & & \searrow & & \searrow \\
 X & & Y & & Z
 \end{array}$$

The pullback is as shown by lemma 1.54, and the resulting span is an anafunctor because $V \rightarrow Y_0$, and hence $U \times_{Y_0} V \rightarrow X_0$, is a cover, and using (3). We will sometimes denote the composite by $(U \times_{Y_0} V, g \circ f^V)$.

REMARK 1.65. If one does not impose the existence of pullbacks on S (as in say **Diff**, see comment 1.2), this composite span still exists, because $V \rightarrow Y_0$ is a cover.

Consider the special case when $V = Y_0$, and hence (Y_0, g) is just an ordinary functor. Then there is a renaming transformation (the identity transformation!) $(Y_0, g) \circ (U, f) \Rightarrow (U, g \circ f)$, using the equality $U \times_{Y_0} Y_0 = U$. If we let $g = \text{id}_Y$, then we see that (Y_0, id_Y) is a strict unit on the left for anafunctor composition. Similarly, considering $(V, g) \circ (Y_0, \text{id})$, we see that (Y_0, id_Y) is a two-sided strict unit for anafunctor composition. In fact, we have also proved

LEMMA 1.66. *Given two functors $f: X \rightarrow Y$, $g: Y \rightarrow Z$ in S , their composition as anafunctors is equal to their composition as functors:*

$$(Y_0, g) \circ (X_0, f) = (X_0, g \circ f).$$

A simple but useful criterion for describing isotransformations where either of the anafunctors is a functor is as follows.

LEMMA 1.67. *An anafunctor $(V, g): X \dashrightarrow Y$ is isomorphic to a functor $f: X \rightarrow Y$ if and only if there is a natural isomorphism*

$$\begin{array}{ccc}
 & X[V] & \\
 \swarrow & & \searrow \\
 X & & Y \\
 & \cong & \\
 & \xrightarrow{f} &
 \end{array}$$

In a site (S, J) where the axiom of choice holds (that is, every epimorphism has a section), one can prove that every J -equivalence between internal categories is in fact an internal equivalence of categories. It is precisely the lack of splittings that prevents this theorem from holding in general sites. The best one can do in a general site is described in the the following two lemmas.

LEMMA 1.68. Let $f: X \rightarrow Y$ be a J -equivalence in (S, J) , and choose a cover $U \rightarrow Y_0$ and a local section $s: U \rightarrow X_0 \times_{Y_0} Y_1^{iso}$. Then there is a functor $Y[U] \rightarrow X$ with object component $s' := \text{pr}_1 \circ s: U \rightarrow X_0$.

Proof. The object component is given, we just need the arrow component. Denote the local section by $(s', \iota): U \rightarrow X_0 \times_{Y_0} Y_1^{iso}$. Consider the composite

$$Y[U]_1 \simeq U \times_{Y_0} Y_1 \times_{Y_0} U \xrightarrow{(s', \iota) \times \text{id} \times (-\iota, s')} (X_0 \times_{Y_0} Y_1^{iso}) \times_{Y_0} Y_1 \times_{Y_0} (Y_1^{iso} \times_{Y_0} X_0) \hookrightarrow \\ X_0 \times_{Y_0} Y_3 \times_{Y_0} X_0 \xrightarrow{\text{id} \times m \times \text{id}} X_0 \times_{Y_0} Y_1 \times_{Y_0} X_0 \simeq X_1$$

It is clear that this commutes with source and target, because these are projection on the first and last factor at each step. To see that it respects identities and composition, just use the fact that the ι component will cancel with the $-\iota$ component. \square

Hence there is an anafunctor $Y \dashrightarrow X$, and the next proposition tells us this is a pseudoinverse to f (in a sense to be made precise in proposition 1.74 below).

LEMMA 1.69. Let $f: X \rightarrow Y$ be a J -equivalence in S . There is an anafunctor

$$(U, \bar{f}): Y \dashrightarrow X$$

and isotransformations

$$\iota: (X_0, f) \circ (U, \bar{f}) \Rightarrow \text{id}_Y \\ \epsilon: (U, \bar{f}) \circ (X_0, f) \Rightarrow \text{id}_X$$

Proof. We have the anafunctor (U, \bar{f}) from the previous lemma. Since the anafunctors id_X, id_Y are actually functors, we can use lemma 1.67. Using the special case of anafunctor composition when the second is a functor, this tells us that ι will be given by a natural isomorphism

$$\begin{array}{ccc} & X & \\ \bar{f} \nearrow & \Downarrow & \searrow f \\ Y[U] & \longrightarrow & Y \end{array}$$

This has component $\iota: U \rightarrow Y_1^{iso}$, using the notation from the proof of the previous lemma. Notice that the composite $f_1 \circ \bar{f}_1$ is just

$$Y[U]_1 \simeq U \times_{Y_0} Y_1 \times_{Y_0} U \xrightarrow{\iota \times \text{id} \times -\iota} Y_1^{iso} \times_{Y_0} Y_1 \times_{Y_0} Y_1^{iso} \hookrightarrow Y_3 \xrightarrow{m} Y_1.$$

Since the arrow component of $Y[U] \rightarrow Y$ is $U \times_{Y_0} Y_1 \times_{Y_0} U \xrightarrow{\text{pr}_2} Y_1$, ι is indeed a natural isomorphism using the diagram (1).

The other isotransformation is between $(X_0 \times_{Y_0} U, \bar{f} \circ \text{pr}_2)$ and (X_0, id_X) , and is given by the arrow

$$\epsilon: X_0 \times_{X_0} X_0 \times_{Y_0} U \simeq X_0 \times_{Y_0} U \xrightarrow{\text{id} \times (s', a)} X_0 \times_{Y_0} (X_0 \times_{Y_0} Y_1) \simeq X_0^2 \times_{Y_0^2} Y_1 \simeq X_1$$

This has the correct source and target, as the object component of \bar{f} is s' , and the source is given by projection on the first factor of $X_0 \times_{Y_0} U$. This diagram

$$\begin{array}{ccc}
(X_0 \times_{Y_0^2} U)^2 \times_{X_0^2} X_1 & \xrightarrow{\text{pr}_2} & X_1 \\
\downarrow \simeq & & \downarrow \simeq \\
U \times_{Y_0} X_1 \times_{Y_0} U & & \\
\downarrow -\iota \times f \times \iota & & \\
(X_0 \times_{Y_0} Y_1^{iso}) \times_{Y_0} Y_1 \times_{Y_0} (Y_1^{iso} \times_{Y_0} X_0) & \xrightarrow{\text{id} \times m \times \text{id}} & X_0 \times_{Y_0} Y_1 \times_{Y_0} X_0
\end{array}$$

commutes, and using (1) we see that ϵ is natural. \square

Just as there is composition of natural transformations between internal functors, there is a composition of transformations between internal anafunctors [Bar06]. This is where the effectiveness of our covers will be used in order to construct a map locally over some cover. Consider the following diagram

$$\begin{array}{ccccc}
& & X[U \times_{X_0} V \times_{X_0} W] & & \\
& \swarrow & & \searrow & \\
X[U \times_{X_0} V] & & & & X[V \times_{X_0} W] \\
\swarrow & & \searrow & & \swarrow \\
X[U] & \xrightarrow{a} & X[V] & \xrightarrow{b} & X[W] \\
\searrow & & \downarrow g & & \swarrow h \\
& & Y & &
\end{array}$$

from which we can form a natural transformation between the leftmost and the rightmost composites as functors in S . This will have as its component the arrow

$$\tilde{b}a: U \times_{X_0} V \times_{X_0} W \xrightarrow{\text{id} \times \Delta \times \text{id}} U \times_{X_0} V \times_{X_0} V \times_{X_0} W \xrightarrow{a \times b} Y_1 \times_{Y_0} Y_1 \xrightarrow{m} Y_1$$

in S . Notice that the Čech groupoid of the cover

$$(5) \quad U \times_{X_0} V \times_{X_0} W \rightarrow U \times_{X_0} W$$

is

$$U \times_{X_0} V \times_{X_0} V \times_{X_0} W \rightrightarrows U \times_{X_0} V \times_{X_0} W,$$

using the two projections $V \times_{X_0} V \rightarrow V$. Denote this pair of parallel arrows by $s, t: UV^2W \rightrightarrows UVW$ for brevity. In [Bar06] we find this commuting diagram

$$(6) \quad \begin{array}{ccc} UV^2W & \xrightarrow{t} & UVW \\ s \downarrow & & \downarrow \tilde{b}a \\ UVW & \xrightarrow{\tilde{b}a} & Y_1 \end{array}$$

and so we have a functor $\check{C}(U \times_{X_0} V \times_{X_0} W) \rightarrow \text{disc}(Y_1)$. Our pretopology J is assumed to be subcanonical, and using remark 1.31 this gives us a unique arrow $ba: U \times_{X_0} W \rightarrow Y_1$, the composite of a and b .

REMARK 1.70. In the special case that $U \times_{X_0} V \times_{X_0} W \rightarrow U \times_{X_0} W$ is an isomorphism (or is even just split), the composite transformation has

$$U \times_{X_0} W \rightarrow U \times_{X_0} V \times_{X_0} W \xrightarrow{\tilde{ba}} Y_1$$

as its component arrow. In particular, this is the case if one of a or b is a renaming transformation.

EXAMPLE 1.71. Let $(U, f) : X \dashrightarrow Y$ be an anafunctor and $U'' \xrightarrow{j'} U' \xrightarrow{j} U$ successive refinements of $U \rightarrow X_0$ (e.g isomorphisms). Let $(U', f_{U'})$, $(U'', f_{U''})$ denote the composites of f with $X[U'] \rightarrow X[U]$ and $X[U''] \rightarrow X[U]$ respectively. The arrow

$$U \times_{X_0} U'' \xrightarrow{\text{id}_U \times j \circ j'} U \times_{X_0} U \rightarrow Y_1$$

is the component for the composition of the isotransformations $(U, f) \Rightarrow (U', f_{U'}) \Rightarrow (U'', f_{U''})$ described in example 1.63. Thus we can see that the composite of renaming transformations associated to isomorphisms ϕ_1, ϕ_2 is simply the renaming transformation associated to their composite $\phi_1 \circ \phi_2$.

EXAMPLE 1.72. If $a: f \Rightarrow g$, $b: g \Rightarrow h$ are natural transformations between functors $f, g, h: X \rightarrow Y$ in S , their composite as transformations between anafunctors

$$(X_0, f), (X_0, g), (X_0, h): X \dashrightarrow Y.$$

is just their composite as natural transformations. This uses the equality

$$X_0 \times_{X_0} X_0 \times_{X_0} X_0 = X_0 \times_{X_0} X_0 = X_0.$$

THEOREM 1.73. [Bar06] *For a site (S, J) where J is a subcanonical singleton pretopology, internal categories (resp. groupoids), anafunctors and transformations form a bicategory $\mathbf{AnaCat}(S, J)$ (resp. $\mathbf{Ana}(S, J)$).*

There is a strict 2-functor $\mathbf{Ana}(S, J) \rightarrow \mathbf{AnaCat}(S, J)$ which is the identity on 0-cells and induces isomorphisms on hom-categories. The following is the main result of this section, and allows us to relate anafunctors to the localisations considered in the next section.

PROPOSITION 1.74. *There are strict 2-functors*

$$\begin{aligned} \alpha_J: \mathbf{Cat}(S) &\rightarrow \mathbf{AnaCat}(S, J), \\ \beta_J = \alpha_J|_{\mathbf{Gpd}(S)}: \mathbf{Gpd}(S) &\rightarrow \mathbf{Ana}(S, J) \end{aligned}$$

sending J -equivalences to equivalences such that

$$\begin{array}{ccc} \mathbf{Gpd}(S) & \hookrightarrow & \mathbf{Cat}(S) \\ \beta_J \downarrow & & \downarrow \alpha_J \\ \mathbf{Ana}(S, J) & \hookrightarrow & \mathbf{AnaCat}(S, J) \end{array}$$

commutes.

Proof. We define α_J and β_J to be the identity on objects, and as described in examples 1.57, 1.60 on 1-cells and 2-cells (i.e. functors and transformations). We need first to show that this gives a functor $\mathbf{Cat}(S)(X, Y) \rightarrow \mathbf{AnaCat}(S, J)(X, Y)$. This is precisely the content of example 1.72. Since the identity 1-cell on a category X in $\mathbf{AnaCat}(S, J)$ is the image of the identity functor on S in $\mathbf{Cat}(S)$, α_J and β_J respect identity 1-cells. Also, lemma 1.66 tells us that α_J and β_J respect composition. That α_J and β_J send J -equivalences to equivalences is the content of lemma 1.69. \square

5. Localising bicategories at a class of 1-cells

Ultimately we are interesting in inverting all weak equivalences in $\mathbf{Gpd}(S)$, and so need to discuss what it means to add the formal pseudoinverses to a class of 1-cells in a 2-category - a process known as *localisation*. This was done in [Pro96] for the more general case of a class of 1-cells in a bicategory, where the resulting bicategory is constructed and its universal properties (analogous to those of a quotient) examined. The application in *loc. cit.* is to showing the equivalence of various bicategories of stacks to localisations of 2-categories of groupoids. The results of this chapter can be seen as one-half of a generalisation of these results to an arbitrary site with pullbacks.

DEFINITION 1.75. Let E be a class of arrows in the ambient category S . E is called a *class of admissible maps for J* if it is a singleton pretopology in which a given singleton pretopology J is cofinal, and satisfying the following condition:

- (S) E contains the split epimorphisms, and if $e: A \rightarrow B$ is a split epimorphism, and $A \xrightarrow{e} B \xrightarrow{p} C$ is in E , then $p \in E$.

EXAMPLE 1.76. If E is a saturated singleton pretopology, it is a class of admissible maps for itself, and $(J\text{-epi})$ is a class of admissible maps for J (they satisfy condition (S) because they are saturated). A singleton pretopology satisfying condition (S) is a class of admissible maps for itself, and will just be referred to as a *class of admissible maps*. In particular, E could be the class of J -epimorphisms for a non-singleton pretopology J .

DEFINITION 1.77. [EKvdL05] Let E be some class of admissible maps in a category S . A functor $X \rightarrow Y$ in S is called an *E -equivalence* if it is fully faithful, and

$$X_0 \times_{Y_0} Y_1^{iso} \xrightarrow{t_{\text{opr}_2}} Y_0$$

is in E . If this last condition holds we will say the functor is essentially E -surjective.

If $E = (J\text{-epi})$ for some pretopology J , we will still refer to J -equivalences. The class of E -equivalences will be denoted W_E .

DEFINITION 1.78. [Pro96] Let B be a bicategory and $W \subset B_1$ a class of 1-cells. A localisation of B with respect to W is a bicategory $B[W^{-1}]$ and a weak 2-functor

$$U: B \rightarrow B[W^{-1}]$$

such that: U sends elements of W to equivalences, and is universal with this property i.e. composition with U gives an equivalence of bicategories

$$U^*: \text{Hom}(B[W^{-1}], D) \rightarrow \text{Hom}_W(B, D),$$

where Hom_W denotes the sub-bicategory of weak 2-functors that send elements of W to equivalences (call these W -inverting, abusing notation slightly).

The universal property means that W -inverting weak 2-functors $F: B \rightarrow D$ factor, up to a transformation, through $B[W^{-1}]$, inducing an essentially unique weak 2-functor $\tilde{F}: B[W^{-1}] \rightarrow D$.

DEFINITION 1.79. [Pro96] Let B be a bicategory B with a class W of 1-cells. W is said to admit a right calculus of fractions if it satisfies the following conditions

2CF1. W contains all equivalences

2CF2. a) W is closed under composition

b) If $a \in W$ and a iso-2-cell $a \xrightarrow{\sim} b$ then $b \in W$

2CF3. For all $w: A' \rightarrow A$, $f: C \rightarrow A$ with $w \in W$ there exists a 2-commutative square

$$\begin{array}{ccc} P & \xrightarrow{g} & A' \\ \downarrow v & \searrow \simeq & \downarrow w \\ C & \xrightarrow{f} & A \end{array}$$

with $v \in W$.

2CF4. If $\alpha: w \circ f \Rightarrow w \circ g$ is a 2-cell and $w \in W$ there is a 1-cell $v \in W$ and a 2-cell $\beta: f \circ v \Rightarrow g \circ v$ such that $\alpha \circ v = w \circ \beta$. Moreover: when α is an iso-2-cell, we require β to be an isomorphism too; when v' and β' form another such pair, there exist 1-cells u, u' such that $v \circ u$ and $v' \circ u'$ are in W , and an iso-2-cell $\epsilon: v \circ u \Rightarrow v' \circ u'$ such that the following diagram commutes:

$$(7) \quad \begin{array}{ccc} f \circ v \circ u & \xrightarrow{\beta \circ u} & g \circ v \circ u \\ \Downarrow f \circ \epsilon \simeq & & \Downarrow \simeq g \circ \epsilon \\ f \circ v' \circ u' & \xrightarrow{\beta' \circ u'} & g \circ v' \circ u' \end{array}$$

REMARK 1.80. In particularly nice cases (as in the next section), the first half of 2CF4 holds due to left-cancellability of elements of W , giving us the canonical choice $v = I$.

THEOREM 1.81. [Pro96] *A bicategory B with a class W that admits a calculus of right fractions has a localisation with respect to W .*

From now on we shall refer to a calculus of right fractions as simply a calculus of fractions, and the resulting localisation as a bicategory of fractions. Since $B[W^{-1}]$ is defined only up to equivalence, it is of great interest to know when a bicategory D in which elements of W are converted to equivalences is itself equivalent to $B[W^{-1}]$. In particular, one would be interested in finding such an equivalent bicategory with a simpler description than that which appears in [Pro96]. Thanks are due to Matthieu Dupont for pointing out (in personal communication) that the statement in *loc. cit.* actually only holds in one direction, as stated below, not in both, as in [Pro96].

PROPOSITION 1.82. [Pro96] *A weak 2-functor $F : B \rightarrow D$ which sends elements of W to equivalences induces an equivalence of bicategories*

$$\tilde{F}: B[W^{-1}] \xrightarrow{\sim} D$$

if the following conditions hold

EF1. F is essentially surjective,

EF2. For every 1-cell $f \in D_1$ there is a $w \in W$ and a $g \in B_1$ such that $Fg \xrightarrow{\sim} f \circ Fw$,

EF3. F is locally fully faithful.

The following is useful in showing a weak 2-functor sends weak equivalences to equivalences, because this condition only needs to be checked on a class that is in some sense cofinal in the weak equivalences.

THEOREM 1.83. *Let the bicategory B admit a calculus of fractions for W , and let $V \subset W$ be a class of 1-cells such that for all $w \in W$, there exists $v \in V$ and $s \in W$ such that there is an invertible 2-cell*

Then a weak 2-functor $F: B \rightarrow D$ that sends elements of V to equivalences also sends elements of W to equivalences.

Proof. In the following the coherence cells will be implicit. First we show that Fw has a pseudosection in C for any $w \in W$. Let v, s be as above. Let \widetilde{Fv} be a pseudoinverse of Fv , and let $j = Fs \circ \widetilde{Fv}$. Then there is the following invertible 2-cell

$$Fw \circ j \Rightarrow F(w \circ s) \circ \widetilde{Fv} \Rightarrow Fv \circ \widetilde{Fv} \Rightarrow I.$$

We now show that j is in fact a pseudoinverse for Fw . Since $s \in W$, there is a $v' \in V$ and $s' \in W$ and a 2-cell giving the following diagram

$$\begin{array}{ccc}
 d & \xrightarrow{v'} & a \\
 \downarrow s' & \Downarrow s & \downarrow w \\
 & \nearrow & \\
 b & \xrightarrow{v} & c
 \end{array}$$

Apply the functor F , and denote pseudoinverses of Fv, Fv' by $\widetilde{Fv}, \widetilde{Fv'}$. Using the 2-cell $I \Rightarrow Fv' \circ \widetilde{Fv'}$ we get the following 2-cell

$$\begin{array}{ccc}
 Fd & \xleftarrow{\widetilde{Fv'}} & Fa \\
 \downarrow Fs & \Leftarrow & \downarrow Fw \\
 Fb & \xrightarrow{Fv} & Fc
 \end{array}$$

Then there is this composite invertible 2-cell

$$j \circ Fw \Rightarrow (Fs \circ \widetilde{Fv}) \circ (Fv \circ (Fs \circ \widetilde{Fv'})) \Rightarrow (Fs \circ Fs') \circ \widetilde{Fv'} \Rightarrow Fv' \circ \widetilde{Fv'} \Rightarrow I,$$

making Fw is an equivalence. Hence F sends all elements of W to equivalences. \square

6. Anafunctors are a localisation

In this section we present the new result that $\mathbf{Cat}(S)$ and $\mathbf{Gpd}(S)$ admit calculi of fractions for the weak equivalences, and the bicategory of anafunctors is an equivalent localisation.

DEFINITION 1.84. (see, e.g. [EKvdL05]) The *isomorphism category* of an internal category X is the internal category denoted $X^{\mathbf{I}}$, with

$$X_0^{\mathbf{I}} = X_1^{iso}, \quad X_1^{\mathbf{I}} = (X_1 \times_{s, X_0, t} X_1^{iso}) \times_{X_1} (X_1^{iso} \times_{s, X_0, t} X_1).$$

where the fibred product over X_1 arises by considering the composition maps

$$\begin{aligned}
 X_1 \times_{s, X_0, t} X_1^{iso} &\rightarrow X_1 \\
 X_1^{iso} \times_{s, X_0, t} X_1 &\rightarrow X_1.
 \end{aligned}$$

Composition in $X^{\mathbf{I}}$ is the same as commutative squares in the case of ordinary categories. There are two functors $\mathbf{s}, \mathbf{t}: X^{\mathbf{I}} \rightarrow X$ which have the usual source and target maps of X as their respective object components.

This construction is an internal version of the functor category $\mathbf{Cat}(\mathbf{I}, C)$, since the groupoid $\mathbf{I} = (\circ \xrightarrow{\simeq} \bullet)$ does not always exist internal to S .

REMARK 1.85. There is an isomorphism $X_1^{\mathbf{I}} \simeq X_1^{iso} \times_{t, X_0, t} X_1 \times_{s, X_0, t} X_1^{iso}$ given by projecting out the last factor in

$$(X_1 \times_{s, X_0, t} X_1^{iso}) \times_{X_1} (X_1^{iso} \times_{s, X_0, t} X_1).$$

The astute reader will recognise the following as an internalisation of the usual notion of weak pullback

DEFINITION 1.86. The *weak pullback* $X \tilde{\times}_Y Z$ of a diagram of internal categories

$$\begin{array}{ccc} & & Z \\ & & \downarrow \\ X & \longrightarrow & Y \end{array}$$

is given by the pullback $X \times_{Y, s} Y^{\mathbf{I}} \times_{t, Y} Z$. There is a 2-commutative square

$$\begin{array}{ccc} X \tilde{\times}_Y Z & \longrightarrow & Z \\ \downarrow & & \downarrow \\ X & \longrightarrow & Y \end{array} \quad \begin{array}{c} \nearrow \\ \approx \\ \searrow \end{array}$$

The following terminology is adapted from [EKvdL05], although strictly speaking this map is only a fibration when model structure from *loc. cit.* exists.

DEFINITION 1.87. An internal functor $f: X \rightarrow Y$ is called a *trivial E-fibration* if it is fully faithful and $f_0 \in E$.

LEMMA 1.88. If a functor $f: X \rightarrow Y$ is an *E-equivalence*,

$$X \times_Y Y^{\mathbf{I}} \xrightarrow{\mathbf{t} \circ \mathbf{pr}_2} Y$$

is a *trivial E-fibration*.

Proof. The object component of $\mathbf{t} \circ \mathbf{pr}_2$ is $t \circ \mathbf{pr}_2$, which is in E by definition if f is essentially E -surjective. Consider now the pullback

$$\begin{array}{ccc} (X_0 \times_{Y_0} Y_1^{iso})^2 \times_{Y_0^2} Y_1 & \longrightarrow & Y_1 \\ \downarrow & & \downarrow \\ (X_0 \times_{Y_0} Y_1^{iso})^2 & \longrightarrow & Y_0 \times Y_0 \end{array}$$

Remark 1.85 tells us that the pullback is isomorphic to $X_0^2 \times_{Y_0^2} Y_1^{\mathbf{I}}$ in the pullback

$$\begin{array}{ccc} X_0^2 \times_{Y_0^2} Y_1^{\mathbf{I}} & \xrightarrow{\text{pr}_2} & Y_1^{\mathbf{I}} \\ \downarrow & & \downarrow \text{pr}_1 \\ X_0^2 & \xrightarrow{\quad} & Y_0 \times Y_0 \end{array}$$

but if f is fully faithful,

$$\begin{aligned} X_0^2 \times_{Y_0^2} Y_1^{\mathbf{I}} &\simeq X_0^2 \times_{Y_0^2} Y_1 \times_{Y_1} Y_1^{\mathbf{I}} \\ &\simeq X_1 \times_{Y_1} Y_1^{\mathbf{I}}, \end{aligned}$$

hence $\mathbf{t} \circ \text{pr}_2$ is fully faithful. □

The internal category $X \times_Y Y^{\mathbf{I}}$ is called the mapping path space construction in [EKvdL05]. If the model structure in *loc. cit.* exists, the above follows from cofibration-acyclic fibration factorisation.

THEOREM 1.89. *Let S be a category with pullbacks and a class E of admissible maps. The 2-categories $\mathbf{Cat}(S)$ and $\mathbf{Gpd}(S)$ admit right calculi of fractions for the class W_E in each.*

Before we prove the theorem, we introduce a lemma

LEMMA 1.90. *Let $f, g: X \rightarrow Y$ be functors and $a: f \Rightarrow g$ a natural isomorphism. There is an isomorphism*

$$X_0^2 \times_{f^2, Y_0^2} Y_1 \simeq X_0^2 \times_{g^2, Y_0^2} Y_1$$

commuting with the projections to X_0^2 .

Proof. Suppressing the canonical isomorphisms $X_0^2 \times_{Y_0^2} Y_1 \simeq X_0 \times_{Y_0} Y_1 \times_{Y_0} X_0$, the required isomorphism is

$$\begin{aligned} X_0 \times_{f, Y_0} Y_1 \times_{Y_0, f} X_0 &\xrightarrow{(\text{id}, -a) \times \text{id} \times (a, \text{id})} X_0 \times_{g, Y_0} Y_1 \times_{Y_0} Y_1 \times_{Y_0} Y_1 \times_{Y_0, g} X_0 \\ &\xrightarrow{\text{id} \times m \times \text{id}} X_0 \times_{g, Y_0} Y_1 \times_{Y_0, g} X_0. \end{aligned}$$

which is the identity map when restricted to the X_0 factors, from which the claim follows. □

COROLLARY 1.91. *If $X = \text{disc}(M)$, the categories $Y[M \xrightarrow{f} Y_0]$ and $Y[M \xrightarrow{g} Y_0]$ are isomorphic.*

Proof. (of theorem 1.89) We show the conditions of definition 1.79 hold.

2CF1. Since E contains all the split epis, an internal equivalence is essentially E -surjective. Let $f: X \rightarrow Y$ be an internal equivalence, and $g: Y \rightarrow X$ a

pseudoinverse. By definition there are natural isomorphisms $a: g \circ f \Rightarrow \text{id}_X$ and $b: f \circ g \Rightarrow \text{id}_Y$. To show that f is fully faithful, we first show that the map

$$q: X_1 \rightarrow X_0^2 \times_{Y_0^2} Y_1$$

is a split monomorphism over X_0^2 . This diagram commutes

$$\begin{array}{ccc} X_1 & \longrightarrow & X_0^2 \times_{Y_0^2} Y_1 \\ \parallel & & \downarrow \\ X_1 & \xleftarrow{\cong} & X_0^2 \times_{gf, X_0^2} X_1, \end{array}$$

by the naturality of a , the marked isomorphism coming from lemma 1.90. The splitting commutes with projection to X_0^2 because the isomorphism does. Call the splitting s . The same argument implies that

$$Y_1 \rightarrow Y_0^2 \times_{X_0^2} X_1$$

is a split monomorphism over Y_0^2 , and this implies the arrow

$$l: X_0^2 \times_{Y_0^2} Y_1 \rightarrow X_0^2 \times_{Y_0^2} Y_0^2 \times_{X_0^2} X_1 \simeq X_0^2 \times_{gf, X_0^2} X_1$$

is a split monomorphism. This diagram commutes

$$\begin{array}{ccccc} X_0^2 \times_{Y_0^2} Y_1 & \xrightarrow{l} & X_0^2 \times_{gf, X_0^2} X_1 & \xrightarrow{\cong} & X_1 \\ \downarrow s & & & & \parallel \\ X_1 & \xrightarrow{q} & X_0^2 \times_{Y_0^2} Y_1 & \xrightarrow{l} & X_0^2 \times_{gf, X_0^2} X_1 & \xrightarrow{\cong} & X_1 \end{array}$$

using naturality again, and so $q \circ s = \text{id}$. Thus q is an isomorphism, and f is fully faithful.

2CF2 a). That the composition of fully faithful functors is again fully faithful is trivial. To show that the composition of essentially E -surjective functors $f: X \rightarrow Y$, $g: Y \rightarrow Z$ is again so, consider the following diagram

$$\begin{array}{ccccc} & & Y_0 \times_{Z_0} Z_1 & \xrightarrow{t} & Z_1 & \xrightarrow{t} & Z_0 \\ & & \downarrow & & \downarrow s & & \\ X_0 \times_{Y_0} Y_1 & \xrightarrow{t} & Y_1 & \xrightarrow{t} & Y_0 & \xrightarrow{g_0} & Z_0 \\ \downarrow & & \downarrow s & & & & \\ X_0 & \xrightarrow{f_0} & Y_0 & & & & \end{array}$$

where the curved arrows are in E by assumption. The lower such arrow pulls back to an arrow $X_0 \times_{Y_0} Y_1 \times_{Z_0} Z_1 \rightarrow Y_0 \times_{Z_0} Z_1$ (again in E). Hence the composite

$$X_0 \times_{Y_0} Y_1 \times_{Z_0} Z_1 \rightarrow Y_0 \times_{Z_0} Z_1 \xrightarrow{\text{topr}_2} Z_0$$

is in E , and is equal to the composite

$$X_0 \times_{Y_0} Y_1 \times_{Z_0} Z_1 \xrightarrow{\text{id} \times g \times \text{id}} X_0 \times_{Z_0} Z_1 \times_{Z_0} Z_1 \xrightarrow{\text{id} \times m} X_0 \times_{Z_0} Z_1 \xrightarrow{\text{topr}_2} Z_0.$$

The map

$$X_0 \times_{Z_0} Z_1 \simeq X_0 \times_{Y_0} Y_0 \times_{Z_0} Z_1 \xrightarrow{\text{id} \times e \times \text{id}} X_0 \times_{Y_0} Y_1 \times_{Z_0} Z_1$$

is a section of

$$X_0 \times_{Y_0} Y_1 \times_{Z_0} Z_1 \xrightarrow{\text{id} \times g \times \text{id}} X_0 \times_{Z_0} Z_1 \times_{Z_0} Z_1 \xrightarrow{\text{id} \times m} X_0 \times_{Z_0} Z_1.$$

Now condition (S) tells us that $X_0 \times_{Z_0} Z_1 \xrightarrow{t \circ \text{pr}_2} Z_0$ is in E , and $g \circ f$ is essentially E -surjective.

2CF2 b). We will show this in two parts: fully faithful functors are closed under isomorphism, and essentially E -surjective functors are closed under isomorphism. Let $w, f: X \rightarrow Y$ be functors and $a: w \Rightarrow f$ be a natural isomorphism. First, let w be essentially E -surjective. That is,

$$(8) \quad X_0 \times_{w, Y_0, s} Y_1 \xrightarrow{t \circ \text{pr}_2} Y_0$$

is in E . Now note that the map

$$(9) \quad X_0 \times_{f, Y_0, s} Y_1 \xrightarrow{(\text{id}, -a) \times \text{id}} X_0 \times_{w, Y_0, s} Y_1 \times_{t, Y_0, s} Y_1 \xrightarrow{\text{id} \times m} X_0 \times_{w, Y_0, s} Y_1$$

is an isomorphism, and so the composite of 9 and 8 is in E . Thus f is essentially E -surjective.

Now let w be fully faithful. Thus

$$\begin{array}{ccc} X_1 & \xrightarrow{w} & Y_1 \\ \downarrow & & \downarrow \\ X_0 \times X_0 & \longrightarrow & Y_0 \times Y_0 \end{array}$$

is a pullback square. Using lemma 1.90 there is an isomorphism

$$X_1 \simeq X_0 \times_{w, Y_0} Y_1 \times_{Y_0, w} X_0 \simeq X_0 \times_{f, Y_0} Y_1 \times_{Y_0, f} X_0.$$

The composite of this with projection on X_0^2 is $(s, t): X_1 \rightarrow X_0^2$, and the composite with

$$\text{pr}_2: X_0 \times_{f, Y_0} Y_1 \times_{Y_0, f} X_0 \rightarrow Y_1$$

is just f_1 by the diagram 1, and so this diagram commutes

$$\begin{array}{ccc} X_1 & & \\ \searrow & \xrightarrow{\simeq} & \\ X_0^2 \times_{f^2, Y_0^2} Y_1 & \longrightarrow & Y_1 \\ \downarrow & & \downarrow \\ X_0^2 & \xrightarrow{f_0^2} & Y_0^2 \end{array}$$

i.e. f is fully faithful.

2CF3. The existence of a 2-commuting square is easy: take the weak pullback (definition 1.86). Since the weak pullback of an E -equivalence is the strict pullback of a trivial E -fibration (using lemma 1.88), we only need to show that the strict

pullback of a trivial E -fibration is an E -equivalence. By lemma 1.55, the pullback of a trivial E -fibration is fully faithful. Since the object component of pulled back map is the pullback of the object component, which is in E , the pullback of the trivial E -fibration is again a trivial E -fibration.

2CF4. It is proved in [Pro96] that given a natural transformation

$$\begin{array}{ccc}
 & Y & \\
 f \nearrow & & \searrow w \\
 X & \Downarrow a & Z \\
 g \searrow & & \nearrow w \\
 & Y &
 \end{array}$$

where w is fully faithful (e.g. w is in W_E), there is a unique $a': f \Rightarrow g$ such that

$$\begin{array}{ccc}
 & Y & \\
 f \nearrow & & \searrow w \\
 X & \Downarrow a & Z \\
 g \searrow & & \nearrow w \\
 & Y &
 \end{array}
 =
 \begin{array}{ccc}
 & f & \\
 X & \Downarrow a' & Y \xrightarrow{w} Z \\
 & g &
 \end{array}
 .$$

This is the first half of 2CF4, where $v = \text{id}_X$. If $v': W \rightarrow X \in W_E$ such that there is a transformation

$$\begin{array}{ccc}
 & X & \\
 v' \nearrow & & \searrow f \\
 W & \Downarrow b & Y \\
 v' \searrow & & \nearrow g \\
 & X &
 \end{array}$$

satisfying

$$\begin{array}{ccc}
 & X & \\
 v' \nearrow & & \searrow f \\
 W & \Downarrow b & Y \xrightarrow{w} Z \\
 v' \searrow & & \nearrow g \\
 & X &
 \end{array}
 =
 \begin{array}{ccc}
 & Y & \\
 f \nearrow & & \searrow w \\
 W \xrightarrow{v'} X & \Downarrow a & Z \\
 g \searrow & & \nearrow w \\
 & Y &
 \end{array}$$

$$=
 \begin{array}{ccc}
 & f & \\
 W \xrightarrow{v'} X & \Downarrow a' & Y \xrightarrow{w} Z \\
 & g &
 \end{array}
 ,$$

we can choose a J -cover $U \rightarrow X_0$, a functor $u': X[U] \rightarrow W$ and a natural isomorphism

$$\begin{array}{ccc} & X[U] & \\ u' \swarrow & & \searrow u \\ W & \xleftarrow{\epsilon} & X \\ & \searrow v' & \end{array}$$

where, since $J \subset E$, $u \in W_E$, and since $v' \circ u' \xrightarrow{\cong} u$, $v' \circ u' \in W_E$ by 2CF2 a) above. We can apply the first step again, using uniqueness to get

$$\begin{array}{ccc} & X & \\ v' \swarrow & & \searrow f \\ W & \Downarrow b & Y \\ v' \swarrow & & \searrow g \\ & X & \end{array} = W \xrightarrow{v'} \begin{array}{ccc} & X & \\ f \swarrow & & \searrow \\ & \Downarrow a' & \\ g \swarrow & & \searrow & Y \end{array} .$$

We paste this with ϵ ,

$$\begin{array}{ccc} & X[U] & \xrightarrow{u} & X \\ & \searrow u' & \swarrow v' & \downarrow \epsilon \\ W & & & X \\ & \searrow v' & \swarrow f & \downarrow b \\ & & & Y \\ & & \searrow g & \\ & & & X \end{array} = \begin{array}{ccc} & X[U] & \\ \downarrow & \searrow \epsilon & \swarrow f \\ W & \xrightarrow{v'} & X \\ & \searrow v' & \swarrow f \\ & & \downarrow a' \\ & & Y \\ & & \searrow g \end{array} ,$$

which is precisely the diagram (7). Hence 2CF4 holds. \square

If E is a class of admissible maps for J , E -equivalences are J -equivalences and so $W_E \subset W_J$. This means that the 2-functors α_J, β_J in proposition 1.74 send E -equivalences to equivalences. We use this fact and proposition 1.82 to show the following.

THEOREM 1.92. *Let (S, J) be a site with a subcanonical singleton pretopology J and let E be a class of admissible maps for J . Then there are equivalences of bicategories*

$$\begin{aligned} \mathbf{AnaCat}(S, J) &\simeq \mathbf{Cat}(S)[W_E^{-1}] \\ \mathbf{Ana}(S, J) &\simeq \mathbf{Gpd}(S)[W_E^{-1}] \end{aligned}$$

Proof. Let us show the conditions in proposition 1.82 hold. We will only supply the details for α_J , the same arguments clearly apply to β_J .

EF1. α_J (and β_J) are the identity on 0-cells, and hence surjective.

EF2. This is equivalent to showing that for any anafunctor $(U, f): X \dashrightarrow Y$ there are functors w, g such that w is in W_E and

$$(U, f) \xrightarrow{\simeq} \alpha_J(g) \circ \alpha_J(w)^{-1}$$

where $\alpha_J(w)^{-1}$ is some pseudoinverse for $\alpha_J(w)$.

Let w be the functor $X[U] \rightarrow X$ – this has object component in $J \subset E$, hence an E -equivalence – and let $g = f: X[U] \rightarrow Y$. First, note that

$$\begin{array}{ccc} & X[U] & \\ & \swarrow & \searrow \\ X & & X[U] \end{array} \quad \begin{array}{c} \\ \\ = \\ \\ \end{array}$$

is a pseudoinverse for

$$\alpha_J(w) = \begin{array}{ccc} & X[U][U] & \\ & \swarrow \simeq & \searrow \\ X[U] & & X \end{array} .$$

Then the composition $\alpha_J(f) \circ \alpha_J(w)^{-1}$ is

$$\begin{array}{ccc} & X[U \times_U U \times_U U] & \\ & \swarrow & \searrow \\ X & & Y \end{array}$$

which is isomorphic to (U, f) by the renaming transformation arising from the isomorphism $U \times_U U \times_U U \simeq U$.

EF3. If $a: (X_0, f) \Rightarrow (X_0, g)$ is a transformation of anafunctors for functors $f, g: X \rightarrow Y$, it is given by a natural transformation with component

$$X_0 \times_{X_0} X_0 \rightarrow Y_1.$$

Simply precompose with the isomorphism $X_0 \simeq X_0 \times_{X_0} X_0$ to get a unique natural transformation $a: f \Rightarrow g$ such that a is the image of a' under α_J . \square

We now finish on a series of results following from this theorem, using basic properties of pretopologies from section 2.

COROLLARY 1.93. *When J and K are two subcanonical singleton pretopologies on S such that $J_{\text{sat}} = K_{\text{sat}}$, there is an equivalence of bicategories*

$$\mathbf{Ana}(S, J) \simeq \mathbf{Ana}(S, K)$$

Using corollary 1.93 we see that using a cofinal pretopology gives an equivalent bicategory of anafunctors.

If E is any class of admissible maps for subcanonical J , the bicategory of fractions inverting W_E is equivalent to that of J -anafunctors. Hence

COROLLARY 1.94. *Let E be a class of admissible maps for the subcanonical pretopology J . There is an equivalence of bicategories*

$$\mathbf{Cat}(S)[W_E^{-1}] \simeq \mathbf{Cat}(S)[W_J^{-1}]$$

where of course $W_J = W_{J_{\text{sat}}}$. *The same result holds with \mathbf{Cat} replaced by \mathbf{Gpd} .*

Finally, if (S, J) is a superextensive site (like \mathbf{Top} with its usual pretopology of open covers), we have the following result which is useful when J is not a singleton pretopology.

COROLLARY 1.95. *Let (S, J) be a superextensive site where J is a subcanonical pretopology. Then*

$$\mathbf{Gpd}(S)[W_{J_{\text{sat}}}^{-1}] \simeq \mathbf{Ana}(S, \amalg J)$$

Proof. This essentially follows from the corollary to lemma 1.40. □

Obviously this can be combined with previous results, for example if $K \leq \amalg J$, for J a non-singleton pretopology, K -anafunctors localise $\mathbf{Gpd}(S)$ at the class of J -equivalences.

CHAPTER 2

A fundamental bigroupoid for topological groupoids

This chapter is devoted to constructing a fundamental bigroupoid for topological groupoids extending the construction given on \mathbf{Top} in [HKK01] (see also [Ste00], section 8.1). Much of the homotopy theory of spaces can be considered as arising from the structure of \mathbf{Top} considered as a category with interval object I (see, e.g. [KP97]) – this is in contrast to starting out with a model category structure. The properties of the interval and the operations that can be performed with it give rise to fundamental group(oids), homotopies and so forth.

For topological groupoids we need to generalise the notion of path, and so we no longer have a single interval object, but a poset of interval objects, with I as the top element. Likewise for n -dimensional cubes (here we only consider $n \leq 3$) we do not just take the product of intervals (even in this generalised sense), but a lattice of cube-like objects with the ordinary cube as top element. It should be said that these lattices have finite meets, and so given a pair of paths or homotopies, we can always form a common refinement of the domains.

Once we have defined the fundamental groupoid and proved it is a functor

$$\mathbf{Gpd}(\mathbf{Top})_0 \rightarrow \mathbf{Bigpd},$$

(here $\mathbf{Gpd}(\mathbf{Top})_0$ is the 1-category underlying $\mathbf{Gpd}(\mathbf{Top})$) we show that on the sub(-1-)categories $\mathbf{Gpd}, \mathbf{Top} \hookrightarrow \mathbf{Gpd}(\mathbf{Top})$ this gives the expected result, up to equivalence. That is, on spaces our fundamental bigroupoid is equivalent to that of [HKK01, Ste00], here denoted Π_2^T , and on ordinary groupoids gives a bigroupoid equivalent to the original groupoid (which represents its own 2-type). While these are necessary conditions for any construction of a fundamental bigroupoid, they aren't sufficient for some of the intended future applications. For example, the composite functor

$$\mathbf{Gpd}(\mathbf{Top})_0 \xrightarrow{N} s\mathbf{Top} \xrightarrow{\|\cdot\|} \mathbf{Top} \xrightarrow{\Pi_2^T} \mathbf{Bigpd}$$

gives a fundamental bigroupoid functor satisfying our required conditions. Here N is the internal nerve functor, $s\mathbf{Top}$ is the category of simplicial spaces, $\|\cdot\|$ is fat realisation [Seg74] and Π_2^T is the fundamental bigroupoid functor of [HKK01, Ste00]. There are other functors with the desired properties which even land in the category of 2-groupoids.¹ However, we are looking at extending the results

¹An anonymous examiner pointed out the construction

$$\mathbf{Gpd}(\mathbf{Top})_0 \xrightarrow{S} \mathbf{Gpd}(s\mathbf{Set}) \xrightarrow{N} ss\mathbf{Set} \xrightarrow{d} s\mathbf{Set} \xrightarrow{\pi_2^{MS}} 2\mathbf{Gpd}$$

where d is the diagonal functor and π_2^{MS} is the left adjoint to the nerve functor from [MS93], denoted in that article W .

of chapter 5 to the smooth category, and for topological and Lie groupoids, and not just topological spaces as considered there.² As such, any construction of a fundamental bigroupoid which uses geometric/fat realisation or the singular set functor $S : \mathbf{Top} \rightarrow s\mathbf{Set}$ is not sufficiently geometric.

We close by showing that the one-object groupoid \mathbf{BG} and the topological space BG , both of which are meant to classify G -bundles, have equivalent fundamental groupoids, and formulate a conjecture extending this result to arbitrary topological groupoids.

The relevant background on bigroupoids is in appendix A.

1. Preliminaries on topological groupoids and n -partitions

From now on the 2-category $\mathbf{Gpd}(\mathbf{Top})$ will be denoted by TG , and the underlying category will be denoted TG_0 . In this chapter, all groupoids, functors, transformations etc. will unless otherwise specified refer to these concepts as constructed internal to \mathbf{Top} . Topological spaces will be considered as topological groupoids by the functor $\text{disc} : \mathbf{Top} \hookrightarrow TG$. Topological groupoids which are in the (essential) image of $\mathbf{Gpd} \rightarrow TG$ will be called *topologically discrete*, or *t-d*. This is to distinguish them from topological groupoids which are discrete as groupoids i.e. are topological spaces. The t-d groupoid with two objects and a unique isomorphism between them will be denoted $\mathbf{2}$ so as to clearly distinguish it from the interval I . For the rest of this chapter, the only pretopology on \mathbf{Top} under consideration will be \mathbf{IO} – the singleton pretopology associated to the pretopology of open covers.

Anafunctors with domain $\text{disc}(I^n)$ contain, in general, a lot of redundant information. For example, one really only needs to consider finite open covers instead of general open covers. To define our paths and surfaces, we shall only consider anafunctor-like spans where the cover involved is a *closed* cover by rectangles. This helps when concatenating surfaces between paths, because the covers of the two squares will automatically define a cover of the coproduct of the squares. If, on the other hand, we used open covers, a pair of open covers does not become an open cover of the coproduct.

This problem is implicitly considered in [BGNX08] where the authors consider the mapping stack $\text{Map}(S^1, \mathcal{X})$ of a topological stack \mathcal{X} . Given a topological groupoid X presenting \mathcal{X} (which has to satisfy certain not unreasonable conditions), the mapping stack is presented by the topological groupoid consisting of paths as defined in definition 2.28 below. This is topologised as the colimit over partition groupoids \mathbf{p} (definition 2.20), of groupoids of functors $\mathbf{p} \rightarrow X$ with the compact-open topology. The solution there is that the category of stacks is carefully defined so that the pushout in \mathbf{Top} used to define concatenation of loops is preserved by the Yoneda embedding.

REMARK 2.1. Earlier versions of these results used closed covers of I^n by convex polyhedra such that at most $n + 1$ covered any given point. This led to difficulties in

²As mentioned in the introduction, Noohi in [Noo09] constructs a 2-connected cover for Lie 2-groups, which is again a Lie 2-group, but the techniques do not seem to extend to more general topological groupoids.

constructing homotopies inductively, and so the present, cubical approach is used. It would be interesting to see if this discontinued approach could be developed as far as the present techniques. Indeed, there are other choices of ‘covers’ of cubes that one might choose, such as triangulations or covers by open or closed balls (for the Euclidean norm) – whether any of these are better models for higher-dimensional homotopy groups of topological groupoids remains to be seen.

DEFINITION 2.2. The following generalises the idea of a partition of $I = [0, 1]$ to higher dimensions:

- (1) A *rectangle* is a subset $R(\mathbf{x}, \mathbf{y}) = [x_1, y_1] \times \dots \times [x_n, y_n] \subset I^n$ with $x_i < y_i$ for $i = 1, \dots, n$.
- (2) A *rectilinear region* $R \subset I^n$ is a finite union of rectangles such that the interior of R is connected.
- (3) Let $\{R_i\}_{i=1}^n$ be a finite cover of I^n by rectilinear regions such that the intersection $R_i \cap R_j$ for $i \neq j$ is at most $(n - 1)$ -dimensional. The disjoint union $\underline{\mathcal{R}} = \coprod_{i=1}^n R_i$ is called a *pre- n -partition* of I^n , and each R_i is simply called a *region*.
- (4) A pre- n -partition $\underline{\mathcal{R}}$ is called an *n -partition* if each region R_i is a rectangle.

Each (pre-) n -partition $\underline{\mathcal{R}}$ will be understood to be equipped with the canonical map $\underline{\mathcal{R}} \rightarrow I^n$.

EXAMPLE 2.3. A 1-partition is a collection of sub-intervals that cover I and only overlap on their endpoints:

$$\underline{\mathfrak{p}} = [0, t_1] \sqcup [t_1, t_2] \sqcup \dots \sqcup [t_n, 1] \rightarrow I$$

Obviously all pre-1-partitions are 1-partitions and we shall call both simply *partitions*. One partition we shall have recourse to use multiple times is $[0, \frac{1}{2}] \sqcup [\frac{1}{2}, 1]$, which we shall denote by $\underline{\mathfrak{d}}$.

EXAMPLE 2.4. If $\underline{\mathfrak{p}}, \underline{\mathfrak{q}}$ are partitions, the space $\underline{\mathfrak{p}} \times \underline{\mathfrak{q}}$ is a 2-partition. More generally, given partitions $\underline{\mathfrak{p}}_1, \dots, \underline{\mathfrak{p}}_n$, there is an n -partition $\prod_i \underline{\mathfrak{p}}_i$. Such an n -partition will be called *regular*.

EXAMPLE 2.5. There is another operation we shall define on n -partitions, giving back an $(n + 1)$ -partition. For n -partitions $\underline{\mathcal{R}}, \underline{\mathcal{Q}}$ we define $(n + 1)$ -partition

$$\underline{\mathcal{R}} * \underline{\mathcal{Q}} = \left[0, \frac{1}{2}\right] \times \underline{\mathcal{R}} \amalg \left[\frac{1}{2}, 1\right] \times \underline{\mathcal{Q}}.$$

This can be seen as an interpolation between $\underline{\mathcal{R}}$ and $\underline{\mathcal{Q}}$. For $n = 1$, an easy example to see (and draw) is this: let the partition $\underline{\mathcal{R}}$ be given by $\{\frac{1}{3}, \frac{2}{3}\}$ and $\underline{\mathcal{Q}} = \underline{\mathfrak{d}}$. Then the 2-partition $\underline{\mathcal{R}} * \underline{\mathcal{Q}}$ consists of the rectangles in the following picture:

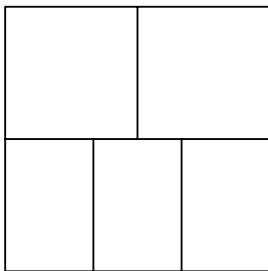

We can define a (pre-) n -partition by specifying the boundaries of the regions in I^n (as far as one can visualise this!). So for example, consider the pre-2-partition $\coprod_{i=1}^6 R_i$:

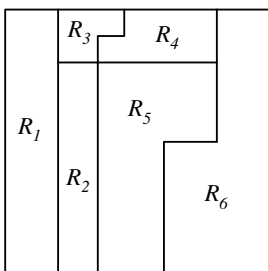

Such a diagram will be called the *picture* of the 2-partition. This can be specified as a pair (I^2, J) where J is the one-dimensional subcomplex of I^2 as shown. In this thesis we shall only be considering $n = 1, 2, 3$ and so will not stretch the mind too much.

DEFINITION 2.6. A *picture* of an (pre-) n -partition is a specification of the boundaries of the regions.

This definition is deliberately a little vague, as there are different ways one might do this.

EXAMPLE 2.7. For partitions, one only needs to specify the endpoints of the subintervals. In example 2.3 one could just give the list of numbers $\{t_1, \dots, t_n\}$.

DEFINITION 2.8. A *refinement* of a (pre-) n -partition \mathcal{R} is a continuous map $\mathcal{R}' \rightarrow \mathcal{R}$ between (pre-) n -partitions as spaces over I^n . This can be specified by adding additional boundaries to the picture of \mathcal{R} .

EXAMPLE 2.9. A refinement of a partition \mathfrak{p} given by $\{t_1, \dots, t_n\}$ just adds additional points $s_1, \dots, s_m \in I - \{t_1, \dots, t_n\}$ to the picture of \mathfrak{p} . An example of a refinement of a pre-2-partition is as follows:

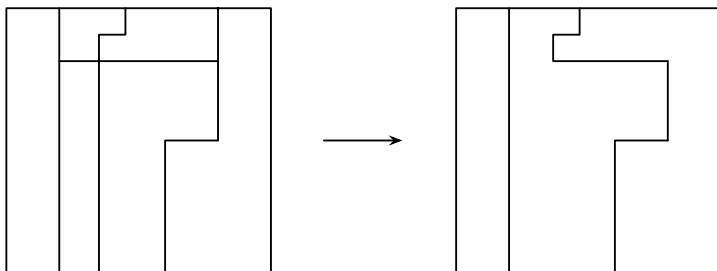

Clearly composition of refinements is a refinement, and the identity map is a refinement, so we have the

DEFINITION 2.10. There is a category $n\text{Part}_{pre}$ (resp. $n\text{Part}$) of pre- n -partitions (resp. n -partitions), where the arrows are refinements.

In actual fact, both of these categories are posets, and are full subcategories of \mathbf{Top}/I^n , with $n\text{Part}$ the full subcategory of $n\text{Part}_{pre}$ with objects the n -partitions. We shall abuse terminology slightly in that given a refinement $\underline{\mathcal{R}}_2 \rightarrow \underline{\mathcal{R}}_1$ we shall also call $\underline{\mathcal{R}}_2$ a refinement of $\underline{\mathcal{R}}_1$.

REMARK 2.11. Clearly n -partitions can be defined for any subspace $[x_1, y_1] \times \dots \times [x_n, y_n] \subset \mathbb{R}^n$, $x_i < y_i$, not just $[0, 1]^n$. In this way we can build up n -partitions from other n -partitions. This gives us a sub-operad of the little n -cubes operad (e.g. [May72]).

We will also want to consider maps between (pre-) n -partitions for varying n . Almost always these will arise as maps covering maps $g: I^n \rightarrow I^m$ of cubes. If we have such a map of cubes (with $n < m$) whose image is parallel to the faces of I^m the pullback $g^*\underline{\mathcal{R}}$ of a (pre-) m -partition is, except in a finite number of cases for each $\underline{\mathcal{R}}$, a (pre-) n -partition, and we have a map $g^*\underline{\mathcal{R}} \rightarrow \underline{\mathcal{R}}$. In other cases, we might want to project out some coordinates $\text{pr}_{i_1 \dots i_m}: I^n \rightarrow I^m$ (clearly $m < n$) and then form the pullback. In the former case we need to give some notation

DEFINITION 2.12. Let $\underline{\mathcal{R}} \rightarrow I^n$ be a (pre-) n -partition and let the coordinates on I^n be x_1, \dots, x_n . The $x_i = \epsilon$ slice of $\underline{\mathcal{R}}$ is the pullback

$$\begin{array}{ccc} \underline{\mathcal{R}}|_{x_i=\epsilon} & \longrightarrow & \underline{\mathcal{R}} \\ \downarrow & & \downarrow \\ I^{n-1} & \xrightarrow{\iota} & I^n \end{array}$$

where the subspace $I^{n-1} \xrightarrow{\iota} I^n$ is determined by $x_i = \epsilon$, $\epsilon = 0, 1$.

Sometimes it will be convenient to work with a pre- n -partition then at the end replace it with an n -partition. This process will be known as improvement.

DEFINITION 2.13. An *improvement* of a pre- n -partition $\underline{\mathcal{R}}$ is a refinement $\underline{\mathcal{R}}' \rightarrow \underline{\mathcal{R}}$ such that $\underline{\mathcal{R}}'$ is an n -partition. Given a refinement $j: \underline{\mathcal{R}}_2 \rightarrow \underline{\mathcal{R}}_1$ of pre- n -partitions, an improvement of j is a commutative square

$$\begin{array}{ccc} \underline{\mathcal{R}}'_2 & \xrightarrow{j'} & \underline{\mathcal{R}}'_1 \\ \downarrow & & \downarrow \\ \underline{\mathcal{R}}_2 & \xrightarrow{j} & \underline{\mathcal{R}}_1 \end{array}$$

where $\underline{\mathcal{R}}'_i \in n\text{Part}$. The common refinement of a pair of improvements is obviously also an improvement.

EXAMPLE 2.14. Given the pre-2-partition picture from before, here is an example of an improvement:

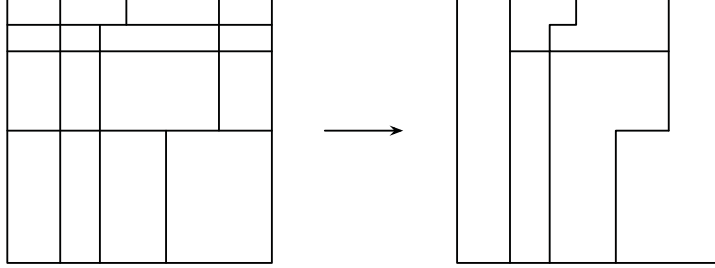

This example illustrates how one can choose an improvement for any pre-2-partition: in the picture of the pre-2-partition, extend all the horizontal lines so they touch both edges of the square. This clearly extends to higher dimensions:

One can theoretically choose an improvement by a regular n -partition (see example 2.4) for any pre- n -partition, but the constraints of the problem at hand may not allow this (in fact this will almost always be the case). However, the choice of improvement turns out not to matter. The following lemma will be used later in showing this fact.

LEMMA 2.15. *If $\underline{\mathcal{R}}_0, \underline{\mathcal{R}}_1$ are two improvements of $\underline{\mathcal{R}}$, a pre- n -partition, there is an $(n + 1)$ -partition $\underline{\mathcal{Q}}$ such that $\underline{\mathcal{Q}}|_{x_1=\epsilon} = \underline{\mathcal{R}}_\epsilon$, $\epsilon = 0, 1$ and x_1 the first coordinate in I^n .*

Proof. Just take $\underline{\mathcal{Q}}$ to be the $(n + 1)$ -partition $\underline{\mathcal{R}}_0 * \underline{\mathcal{R}}_1$ □

Just as with open covers, we are interested in when we can form a common refinement of a pair of n -partitions.

DEFINITION 2.16. If $\underline{\mathcal{R}} = \coprod_k R_k$ and $\underline{\mathcal{Q}} = \coprod_j Q_j$ are two n -partitions, they have a *common refinement* $\underline{\mathcal{RQ}}$, given by disjoint union of those intersections $R_k \cap Q_j$ that are n -dimensional.

Notice that $\underline{\mathcal{R}}\underline{\mathcal{R}} = \underline{\mathcal{R}}$, and for any common refinement, there are morphisms

$$\underline{\mathcal{R}} \leftarrow \underline{\mathcal{RQ}} \rightarrow \underline{\mathcal{Q}}$$

in $n\text{Part}$.

EXAMPLE 2.17. Given a pair of partitions given by $\{t_1, \dots, t_n\}$, $\{s_1, \dots, s_m\}$, their common refinement is given by the union $\{t_1, \dots, t_n\} \cup \{s_1, \dots, s_m\}$.

EXAMPLE 2.18. Given the pictures of a pair of 2-partitions, their common refinement is given by overlaying the first pictures on top of the second.

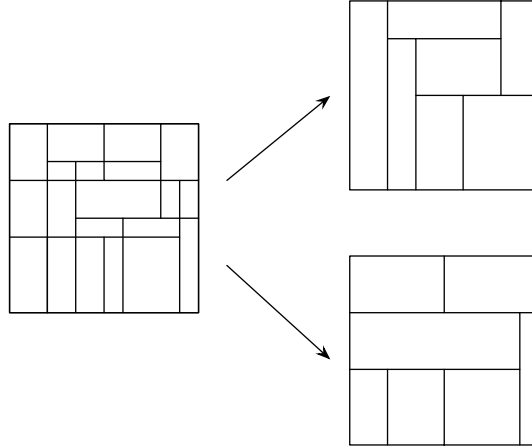

Since we will be dealing with anafunctors (with respect to the pretopology of open covers) between topological groupoids, we need to know how maps from cubes into spaces with open covers behave.

LEMMA 2.19. *For an open cover $U \rightarrow I^n$ of the cube, there is an n -partition $\underline{\mathcal{R}}$ and a map $\underline{\mathcal{R}} \rightarrow U$ over I^n .*

Proof. Take a finite subcover $U' \subset U$, and consider the cube I^n as having the metric $d_\infty(\mathbf{x}, \mathbf{y}) = \max\{|x_i - y_i|\}$. The cube is compact (in this metric) and so we apply the Lebesgue covering lemma (see e.g. [Bro06], page 91) to get the Lebesgue number δ of the cover U' . We can then choose an N such that $1/N < \delta/2$ and cover I^n by closed ‘balls’ R_i for this metric (which are cubes) of diameter (i.e. side length) $1/N$. Clearly we can do this in such a way that the resulting disjoint union $\coprod R_i$ is an n -partition (i.e. the R_i s only overlap on their boundaries). \square

We say that an open cover of the cube is thus refined by an n -partition.

Recall that for a map $Y \rightarrow X$ in **Top**, the Čech groupoid $\check{C}(Y)$ is the topological groupoid with objects Y , morphisms $Y \times_X Y$ and the two projections are source and target. Let $\underline{\mathcal{R}}$ be an (pre-) n -partition.

DEFINITION 2.20. An (pre-) n -partition groupoid is the Čech groupoid of the map $\underline{\mathcal{R}} \rightarrow I^n$. This means that the object space is the disjoint union of regions, and the arrow space is the disjoint union of their (ordered) pairwise intersections. We denote the corresponding (pre-) n -partition groupoid by \mathcal{R} .

Let $n\text{PartGpd}$ (resp. $n\text{Part}_{pre}\text{Gpd}$) denote the subcategory of $TG/\text{disc}(I^n)$ with objects the n -partition groupoids $\mathcal{R} \rightarrow I^n$ (resp. pre- n -partition groupoids).

A refinement of n -partitions $\underline{\mathcal{R}}_2 \rightarrow \underline{\mathcal{R}}_1$ induces a functor over $\text{disc}(I)$ between the respective n -partition groupoids. The inclusion $\underline{\mathcal{R}}|_{x_i=\epsilon} \rightarrow \underline{\mathcal{R}}$ also gives a functor between the respective partition groupoids. The common refinement of a pair of n -partition groupoids is the groupoid associated to the common refinement of the underlying n -partitions. The same goes for other operations, such as $- * -$. One might think that the fibred product $\mathcal{R}_1 \times_{I^n} \mathcal{R}_2$ would be a more natural object to study than the common refinement $\mathcal{R}_1 \mathcal{R}_2$, but we have the following result

LEMMA 2.21. For n -partition groupoids \mathcal{R}_1 and \mathcal{R}_2 ,

$$i: \mathcal{R}_1 \mathcal{R}_2 \hookrightarrow \mathcal{R}_1 \times_{I^n} \mathcal{R}_2$$

is a subgroupoid and there is a retract

$$r: \mathcal{R}_1 \times_{I^n} \mathcal{R}_2 \rightarrow \mathcal{R}_1 \mathcal{R}_2$$

such that $i \circ r \simeq \text{id}$. As a result, the common refinement and the fibred product are internally equivalent in $TG/\text{disc}(I^n)$.

Proof. Since the objects of $\mathcal{R}_1 \mathcal{R}_2$ are a subspace of the objects of $\mathcal{R}_1 \times_{I^n} \mathcal{R}_2$, there is an obvious inclusion functor commuting with the projections to $\text{disc}(I^n)$. To define the retract on objects (which is sufficient, as we are dealing with Čech groupoids), let each intersection $R_1 \cap R_2$ in $\mathcal{R}_1 \times_{I^n} \mathcal{R}_2$ with $\dim(R_1 \cap R_2) = n$ be mapped to itself. For intersections $R_1 \cap R_2$ with $\dim(R_1 \cap R_2) < n$, define the retract to map them into R_1 . To see that there is the natural isomorphism as stated, the components are simply given by $(a, b) \mapsto (a, b; i \circ r(a, b))$. Naturality is immediate. \square

EXAMPLE 2.22. If there are arrows $\mathcal{R}' \rightarrow \mathcal{R} \leftarrow \mathcal{Q}$ in $n\text{PartGpd}$, there is a functor

$$\mathcal{R}' * \mathcal{Q} \rightarrow \mathbf{2} \times \mathcal{R}$$

It will often be the case that \mathcal{R}' or \mathcal{Q} is equal to \mathcal{R} .

It is important to distinguish between *functors* between n -partition groupoids and arrows in $n\text{PartGpd}$ (i.e. refinements). Most often this distinction will arise when we consider a commutative square of functors where the top two corners are n -partition groupoids and the lower two corners are cubes (not necessarily the same dimension). Unless the map along the bottom is the identity map, and hence the cubes are the same dimension, this is most definitely not a refinement.

LEMMA 2.23. There is an isomorphism of categories $n\text{Part} \rightarrow n\text{PartGpd}$.

Proof. Obvious. \square

REMARK 2.24. A 1-partition groupoid will just be referred to as a *partition groupoid*. Note also that an n -partition groupoid is nothing like a partition n -groupoid (whatever that is) except for $n = 1$!

REMARK 2.25. In this thesis, we will only be concerned with n -partition groupoids for $n = 1, 2, 3$, and so give them their own symbols. 1-partition groupoids will generally be denoted by such letters as $\mathfrak{p}, \mathfrak{q}$, 2-partition groupoids by $\mathfrak{h}, \mathfrak{g}$ and 3-partition groupoids by $\mathfrak{H}, \mathfrak{G}$. The corresponding n -partitions will be represented by the same symbols only underlined.

We need to be able to discuss coordinates on the groupoids $\mathfrak{p}, \mathfrak{h}$ and \mathfrak{H} . For generic points in any of these we are simply considering points in the interior of a region, as a subspace of the object space, and so can label them by the underlying coordinates of I^n . However, for the groupoid \mathfrak{d} , the fibre at $\frac{1}{2}$ of the projection to

I is the groupoid $\mathbf{2}$, so we need a way of uniquely identifying: 1) objects of \mathcal{R} over the same point in I^n , and 2) morphisms between these, which of course cover an identity arrow in $\text{disc}(I^n)$.

Before we address these two points we need to fix coordinates on the underlying I^n , or more precisely, on the pictures that we will use to specify n -partitions.

- The interval I is generically labelled with the coordinate t , running from left to right.

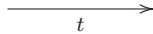

- The square I^2 is generically labelled with the coordinates s and t , oriented as follows

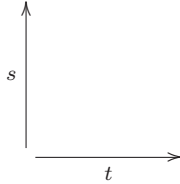

As a result, when we consider surfaces represented pictorially as squares, and as being bounded by paths at the ‘top’ and ‘bottom’, the label of the coordinate induced on the edges considered as subspaces $\{\epsilon\} \times I \subset I^2$ ($\epsilon = 0, 1$) matches the already existing label, namely t .

- The cube I^3 is generically labelled with the coordinates r , s and t , oriented as follows

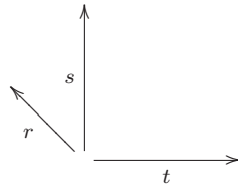

where r runs back into the page. Analogously to the previous case, the induced coordinates on the front and back faces of a cube have the same labels as a square.

Now we need to describe the coordinates on an n -partition groupoid $\mathcal{R} \rightarrow I^n$. For any given coordinate $x \in [0, 1]$ in the i^{th} direction underlying a point in $\underline{\mathcal{R}}$, one of three things can happen – it can be a generic value, such as occurs in the interior of regions; it can be on the maximal boundary of the region, so that in that direction the region looks like $[a, x]$; or it can be on the minimal boundary of the region, so that in that direction the region looks like $[x, b]$. To distinguish between these cases we shall include in the data of the coordinates on I^n an n -tuple (χ_1, \dots, χ_n) , where each χ_i can take the values $o, -, +$ corresponding to the three cases.

To each point in the n -partition $\underline{\mathcal{R}}$ we associate coordinates $(t_1^{\chi_1}, \dots, t_n^{\chi_n})$, where the symbols χ_i are as described in the previous paragraph. So for the example of $\underline{\mathfrak{d}}$,

we have points t° for $t \in [0, \frac{1}{2}) \amalg (\frac{1}{2}, 1]$ and the points $\frac{1^-}{2}, \frac{1^+}{2}$. Here is an example of a 2-partition and some of the points on it labelled by their coordinates. Take note that this is a ‘left-handed’ coordinate system, with points on I^2 labelled (s, t) .

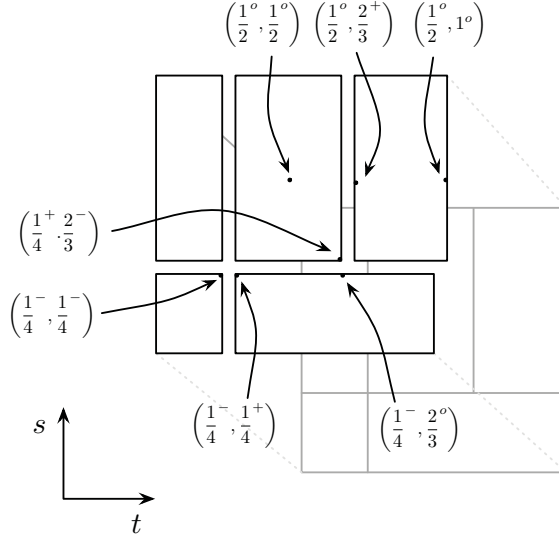

The extension to 3-partitions and higher should be clear.

We need also to talk about coordinates on the arrow space of an n -partition groupoid. This is not a problem as this space is just a fibred product over I^n and there is at most one arrow between any two objects. For the arrow from $(t_1^{X_1}, \dots, t_n^{X_n})$ to $(t_1^{X'_1}, \dots, t_n^{X'_n})$ we shall write $(t_1^{X_1}, t_1^{X'_1}; \dots; t_n^{X_n}, t_n^{X'_n})$. If these are the same point we will still write $\text{id}_{(t_1^{X_1}, \dots, t_n^{X_n})}$ when convenient.

One last technical lemma, and we can proceed to discussing paths in a groupoid.

LEMMA 2.26. *Let $j: \mathcal{R} \rightarrow D$ be a functor from an n -partition groupoid to a t - d groupoid, where $\underline{\mathcal{R}} = \amalg_{i=1}^k R_i$. If $d_i \in D_0$ is the image of R_i , then j factors through a subgroupoid $\text{codisc}(\{d_1, \dots, d_k\}) \hookrightarrow D$.*

Proof. As \mathcal{R} is posetal (there is at one arrow between any an ordered pair of objects), it factors through a subgroupoid of D which is also posetal. Every arrow in this poset is composable, so is a codiscrete groupoid. \square

Subgroupoids such as appear in the lemma will be given a special name.

DEFINITION 2.27. A codiscrete groupoid $\text{codisc}(S) \hookrightarrow X$ to a general topological groupoid will be referred to as a *tree subgroupoid*. In an abuse of notation, mention of the functor will sometimes be suppressed.

We will sometimes need to refer to the subgroupoid of an n -partition groupoid \mathcal{R} that is the pullback along the inclusion $\partial I^n \hookrightarrow I^n$. This subgroupoid will be referred to as the *boundary* of \mathcal{R} and will be denoted $\partial \mathcal{R}$.

2. Paths and surfaces in topological groupoids

DEFINITION 2.28. A *path* in a topological groupoid X is just a functor

$$\gamma: \mathfrak{p} \rightarrow X$$

from a partition groupoid \mathfrak{p} . A *segment* of γ is a path in X_0 that is given by restricting to a connected component of \mathfrak{p} . A *loop* is a path γ such that $\gamma(0) = \gamma(1)$.

The *endpoints* of a path γ are just the images of the objects $0, 1 \in \mathfrak{p}$ under γ . This definition is equivalent to the one in [MM05] for Lie groupoids, developing ideas from [Hae71, Hae90] in the case of foliation groupoids.

EXAMPLE 2.29. For any topological groupoid X and object $x \in X_0$, there is the *constant path* $\underline{x}: I \rightarrow X$.

EXAMPLE 2.30. For a space X , the segments of a path $\mathfrak{p} \rightarrow \text{disc}(X)$ paste together to give a unique path $I \rightarrow X$ in the usual sense.

EXAMPLE 2.31. Let $U \rightarrow X$ be an open cover of the space X . A path $\mathfrak{p} \rightarrow \check{C}(U)$ gives rise to a path subordinate to the cover in the sense that each segment is contained in an open set.

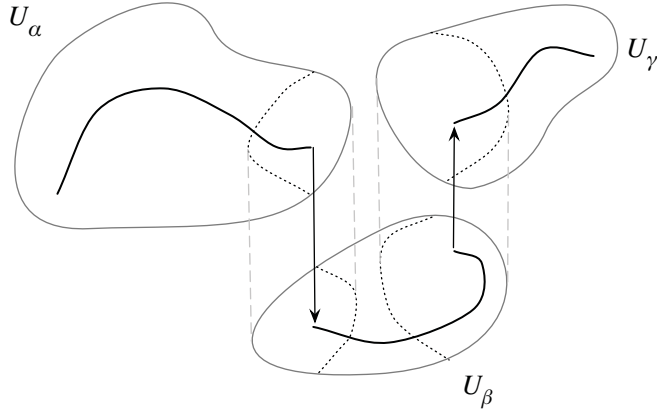

This example (in the context of differential geometry) was considered in [SW09] as a basis for discussing parallel transport of G -bundles as a functor with domain a groupoid of paths. The constructions in this chapter can be seen as a basis for extending a 'parallel transport' formalism to higher-dimensions and for arbitrary groupoids as the base 'space'.

EXAMPLE 2.32. Let D be a groupoid with a discrete object space, such as a t-d groupoid, or the one-object groupoid $\mathbf{B}G$ associated to a topological group. A path in D is a finite sequence of composable arrows. In the case of $\mathbf{B}G$ this is just a finite sequence of elements of G .

Just like paths in a topological space, paths in a groupoid may be traversed in the opposite direction.

DEFINITION 2.33. The *reverse* of a path $\gamma: \mathfrak{p} \rightarrow X$ is the composite

$$\bar{\gamma}: i_t^* \mathfrak{p} \rightarrow \mathfrak{p} \rightarrow X$$

where $i_t: I \rightarrow I$ sends $t \mapsto 1 - t$.

The functor $r^*\mathfrak{p} \rightarrow \mathfrak{p}$ is *not* an arrow in $\mathbf{PartGpd}$, as it does not cover the identity on I . This is typical of operations with paths in groupoids, in that the domain(s) of the path(s) do not stay the same.

We would also like to paste paths whose endpoints agree up to isomorphism. For a partition groupoid \mathfrak{p} given by $\{t_1, \dots, t_n\}$ and $t_j < t_k$, denote by $\mathfrak{p}_{[t_j, t_k]}$ the full subgroupoid of \mathfrak{p} with all objects t with $t_j^+ < t < t_k^-$.

LEMMA 2.34. *Given functors*

$$\begin{aligned} \eta_1 &: \mathfrak{p}_{[0, t_{j_1}]} \rightarrow X \\ \eta_2 &: \mathfrak{p}_{[t_{j_1}, t_{j_2}]} \rightarrow X \\ &\vdots \\ \eta_{p+1} &: \mathfrak{p}_{[t_{j_p}, 1]} \rightarrow X \end{aligned}$$

such that there are arrows $a_i: \eta_i(t_{j_i}^-) \rightarrow \eta_{i+1}(t_{j_i}^+)$ in X , there is a path $\eta: \mathfrak{p} \rightarrow X$ with restriction to the subgroupoids $\mathfrak{p}_{[t_j, t_k]}$ as shown and $\eta(t_{j_i}^-, t_{j_i}^+) = a_i$.

The proof is an easy exercise so it is omitted.

DEFINITION 2.35. The *category of paths* in X , denoted $\mathbf{Path}(X)$ has as objects the paths $\gamma: \mathfrak{p} \rightarrow X$, and as arrows the diagrams

$$(10) \quad \begin{array}{ccc} & \mathfrak{p}\mathfrak{q} & \\ & \swarrow \quad \searrow & \\ \mathfrak{p} & & \mathfrak{q} \\ & \searrow \quad \swarrow & \\ & X & \end{array} \quad \begin{array}{c} \xrightarrow{\gamma} \\ \xrightarrow{a} \\ \xrightarrow{\eta} \end{array}$$

Here γ is the source and η is the target. There are functors $ev_\epsilon: \mathbf{Path}(X) \rightarrow X$, $\epsilon = 0, 1$, sending a path γ to $\gamma(\epsilon)$ and a diagram as above to the evaluation of the natural transformation at ϵ .

Since every natural transformation is a natural isomorphism, $\mathbf{Path}(X)$ is actually a groupoid.

REMARK 2.36. The groupoid $\mathbf{Path}(X)$ is formally analogous to the hom-groupoid $\mathbf{Ana}(\mathbf{disc}(I), X)$ in the bicategory of anafunctors, only this time we are considering finite closed covers of the interval. In studying string topology for stacks, [BGNX08] gives the analogous construction for $\mathbf{Ana}(\mathbf{disc}(S^1), X)$, namely using closed covers of the circle by intervals, to get a topological groupoid LX . In fact, in remark 2.5 of *loc. cit.* it is stated that there is an equivalence between the groupoid of anafunctors and LX when X_1, X_0 are Hausdorff, $(s, t): X_1 \rightarrow X_0 \times X_0$ is proper³ and s and t are local fibrations (these conditions are satisfied when X is a proper Lie groupoid). In addition, the topological groupoid LX is a presentation of the topological loop stack of the stack presented by X . This is another reason to

³not to be confused with the coordinate labels $s, t \in I$!

consider the construction in this chapter over other constructions of a fundamental bigroupoid.

We can also consider the wide subgroupoid $\text{Path}_r(X) \hookrightarrow \text{Path}(X)$ which has for arrows the natural transformations as in (10) such that $a_0 = \text{id}_{\gamma(0)} = \text{id}_{\eta(0)}$ and $a_1 = \text{id}_{\gamma(1)} = \text{id}_{\eta(1)}$. If the objects of $\text{Path}(X)$ can be considered as homotopies of paths, then the objects of $\text{Path}_r(X)$ are analogous to homotopies rel endpoints, and will provide examples of *surfaces* in a groupoid.

In the following, let s, t be the coordinates on I^2 . A surface between paths in a topological groupoid is formally like defining a relative homotopy in a category with an interval object (e.g. [KP97]). Firstly, let $0, 1: * \rightarrow \mathfrak{p}$ denote the obvious inclusions. We say two paths $\mathfrak{p} \rightarrow X$, $\mathfrak{q} \rightarrow X$ have the *same endpoints* if the following diagram exists for $\epsilon = 0, 1$:

$$\begin{array}{ccc} * & \xrightarrow{\epsilon} & \mathfrak{p} \\ \downarrow \epsilon & \searrow x_\epsilon & \downarrow \\ \mathfrak{q} & \xrightarrow{\quad} & X \end{array}$$

The objects $x_0, x_1 \in X_0$ are called the endpoints of the paths. We shall also call $s_0(\gamma) = x_0$ the *source* of the path, and $t_0(\gamma) = x_1$ the *target*.

DEFINITION 2.37. Given two paths in a topological groupoid

$$\gamma_0: \mathfrak{p}_0 \rightarrow X, \quad \gamma_1: \mathfrak{p}_1 \rightarrow X$$

such that they have the same endpoints x_0, x_1 , a *surface between γ_0 and γ_1* (or simply *surface* when the context is clear) is a functor from a 2-partition groupoid

$$f: \mathfrak{h} \rightarrow X$$

such that the diagrams

$$\begin{array}{ccccc} \mathfrak{h}|_{s=0} & \hookrightarrow & \mathfrak{h} & \longleftarrow & \mathfrak{h}|_{s=1} \\ = \downarrow & & \downarrow & & \downarrow = \\ \mathfrak{p}_0 & \xrightarrow{\gamma_0} & X & \xleftarrow{\gamma_1} & \mathfrak{p}_1 \end{array}$$

$$\begin{array}{ccccc} \mathfrak{h}|_{t=0} & \hookrightarrow & \mathfrak{h} & \longleftarrow & \mathfrak{h}|_{t=1} \\ \downarrow & & \downarrow & & \downarrow \\ * & \xrightarrow{x_0} & X & \xleftarrow{x_1} & * \end{array}$$

commute.

Consider a surface $\mathfrak{h} \rightarrow X$ where the 2-partition \mathfrak{h} corresponds to the following picture:

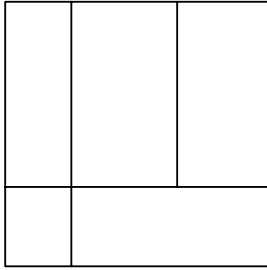

Regions are mapped to rectangles in X_0 (possibly with degenerate edges). Edges in the picture correspond to path of arrows between boundary segments of regions, that is, paths in X_1 . At (internal) vertices in the picture, which can be either 3- or 4-valent, the image of the surface looks like

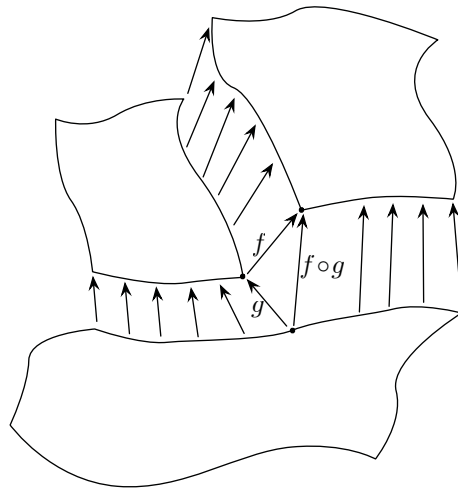

in the 3-valent case, and

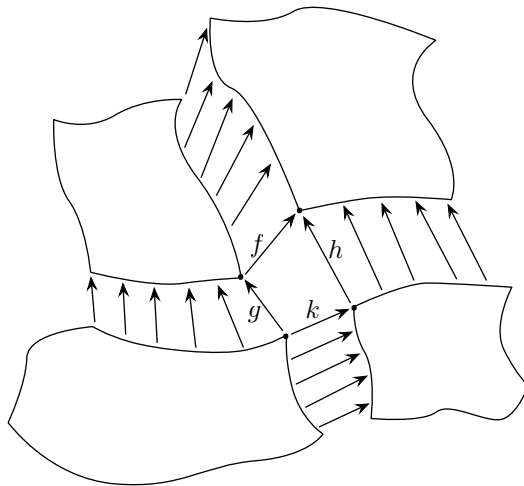

in the 4-valent case, with $f \circ g = h \circ k$. As a result, we have a commutative triangle (or square) corresponding to each vertex in the picture.

REMARK 2.38. For a 2-partition groupoid that is the domain of a surface, we can decorate the corresponding picture so as to indicate features of that surface.

- (1) For a start, since the vertical boundaries factor through the trivial groupoid, we put wiggly lines on those edges.

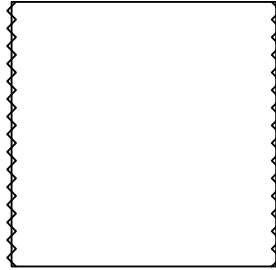

- (2) The same will be done for any external edge that factors through a point, such as the following, where both vertical edges and the top horizontal edge factor through a single point in the object space.

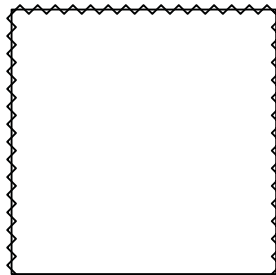

- (3) Dotted edges in a 2-partition still indicate the boundaries of regions, but signify that the functor defining the surface takes values in identity arrows there.

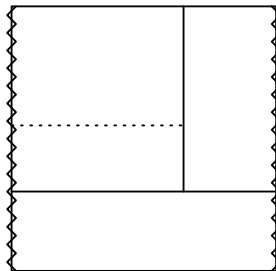

Note that solid edges may also take values at identity arrows, they just are not constrained to do so like dotted edges. Also, the commutative triangle or square attached to a vertex involving a dotted edge has an identity as one of arrows in the diagram.

- (4) A shaded region indicates that portion(s) of the region(s) that are mapped to a point in the object space.

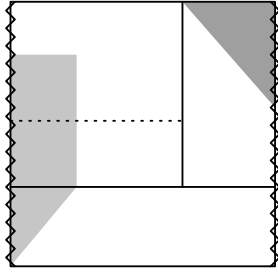

If the shaded area on the left is mapped to the object $p \in X_0$, the edge passing through the shaded area necessarily denotes a path in the topological group $Aut(p)$.

- (5) A label α on an external vertex (top or bottom edge of the picture only), is the arrow $\alpha: x \rightarrow y$ in X which is the value of the functor $\mathfrak{h} \rightarrow X$ on the arrow in \mathfrak{h} corresponding to that vertex.

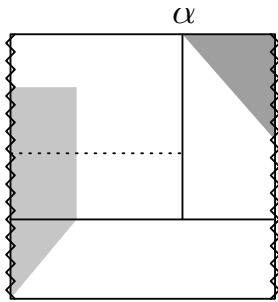

Since we are by default considering coordinates on our 2-partitions to run from bottom to top, and left to right, the arrow α runs from the image of the region on the left to the image of the region on the right.

EXAMPLE 2.39. Let \mathfrak{p} be a 1-partition groupoid. Define a 2-partition groupoid by $I_{\mathfrak{p}} = I \times \mathfrak{p}$. The image of a surface $I_{\mathfrak{p}} \rightarrow X$ looks like

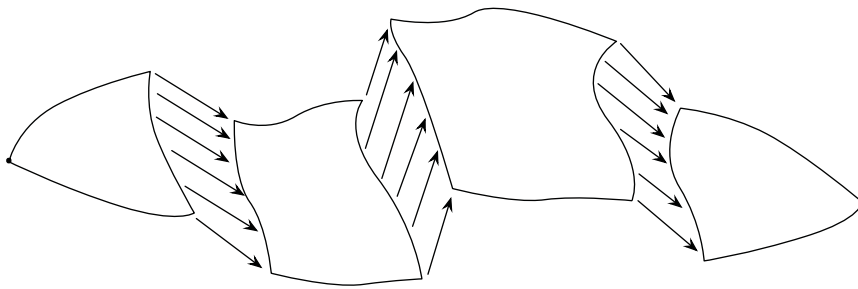

Such a surface will be called a *simple surface*.

If X is a t-d groupoid, or more generally one with a discrete object space, then such a surface is necessarily constant in the s -direction (see example 2.32). The *constant surface* for a given path $\gamma: \mathfrak{p} \rightarrow X$ is the following functor

$$\bar{\gamma}: I \times \mathfrak{p} \xrightarrow{\text{pr}_2} \mathfrak{p} \xrightarrow{\gamma} X$$

and is an example of a simple surface.

EXAMPLE 2.40. Let \mathfrak{p} be a 1-partition groupoid, $\gamma_0, \gamma_1: \mathfrak{p} \rightarrow X$ paths with endpoints x_0, x_1 and $a: \gamma_0 \Rightarrow \gamma_1$ a natural transformation⁴ such that $a_0 = \text{id}_{x_0}$ and $a_1 = \text{id}_{x_1}$. Then there is a surface $f_a: \mathfrak{d} \times \mathfrak{p} \rightarrow \mathbf{2} \times \mathfrak{p} \xrightarrow{a} X$.

This construction shows that there is a function from the set of such natural transformations between a pair of paths to the set of homotopies between those paths. This is not functorial (in the sense that composition of natural transformations is composition of homotopies, see definition 2.80), but once we define equivalence of homotopies (definition 2.55) and form equivalence classes, it will be.

EXAMPLE 2.41. Generalising from the previous example, if $a: \gamma \Rightarrow \eta$ is an arrow in $\text{Path}_r(X)$, where $\gamma: \mathfrak{p} \rightarrow X$ and $\eta: \mathfrak{q} \rightarrow X$, there is a surface

$$\mathfrak{p} * \mathfrak{q} \rightarrow \mathbf{2} \times \mathfrak{p}\mathfrak{q} \rightarrow X,$$

(see example 2.22) which we shall call a *transformation surface*.

This restriction to $\text{Path}_r(X)$ seems a bit artificial, but unless the paths themselves are altered, this is the best that can be done. See corollary 2.124 for a version where we allow general morphisms in $\text{Path}(X)$, but change the paths involved slightly.

EXAMPLE 2.42. If $\gamma: \mathfrak{p} \rightarrow X$ is a path such that one segment is a constant path $[t_i, t_{i+1}] \rightarrow * \rightarrow X_0$, then there is a surface from that path to another path $\gamma': \mathfrak{q} \rightarrow X$ where the constant segment has been removed. If \mathfrak{p} is specified by $\{t_1, \dots, t_n\}$, then \mathfrak{q} is specified by

$$\begin{array}{ll} \{t_1, \dots, t_{i-1}, \frac{t_i+t_{i+1}}{2}, t_{i+2}, \dots, t_n\} & \text{for } i \neq 0, n, \\ \{t_2, \dots, t_n\} & \text{for } i = 0, \\ \{t_1, \dots, t_{n-1}\} & \text{for } i = n. \end{array}$$

where we have implicitly set $t_0 = 0$ and $t_{n+1} = 1$.

The surface between γ and γ' has domain that looks the following example (where $n = 5$ and $i = 4$), from which the general idea can be gleaned.

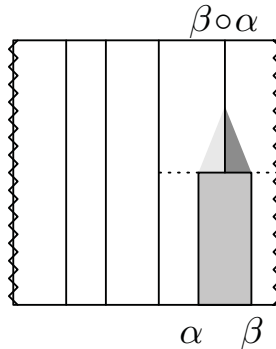

The regions with the shaded triangles are standard reparametrisation homotopies in X_0 , shrinking away the constant path. All other regions are trivial homotopies.

⁴Recall that even though we define natural transformations $a: f \Rightarrow g: X \rightarrow Y$ as arrows from X_0 to Y_1 , there is an equivalent formulation (because the groupoid $\mathbf{2}$ is available) as functors $\mathbf{2} \times X \rightarrow Y$.

EXAMPLE 2.43. Given a path $\gamma: \mathfrak{p} \rightarrow X$ and a refinement $\mathfrak{p}' \rightarrow \mathfrak{p}$ we can form a new path $\gamma[\mathfrak{p}']: \mathfrak{p}' \rightarrow X$. There is a surface between these two paths, given by $\mathfrak{p}' * \mathfrak{p} \rightarrow \mathfrak{p} \rightarrow X$. An example picture is

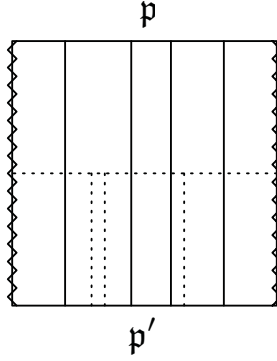

The version of homotopies of paths that appear in [MM05, Col06] correspond to sequences of simple surfaces, transformation surfaces, inserting/removing constant paths and refinements. In *loc. cit.* specific homotopies are not utilised, only the equivalence relation defined by the existence of a homotopy. Since we are considering two-dimensional homotopy information this level of detail is not enough, hence the treatment as above.

3. Thin homotopies and structure morphisms

Since we are going to be constructing a homotopy bigroupoid Π_2^{TG} of a topological groupoid, it is worthwhile to qualitatively review the Hardie-Kamps-Kieboom description of the fundamental bigroupoid of a topological space [HKK01].⁵ Our bigroupoid should reduce (up to equivalence) to theirs upon restricting to the subcategory of TG consisting of spaces. It should be mentioned that such a description most likely dates back to Grothendieck [Gro83], when he discussed the concept of fundamental (weak) n -groupoid. The work involved is mostly in ensuring the coherence conditions are satisfied (as in the appendix), even though conceptually it was clear to the experts what the basic idea was (such as in [BD95], for example).

DEFINITION 2.44. [HKK01, Ste00] The fundamental bigroupoid $\Pi_2^T(X)$ of a space X has the set of points of X as its objects, the set of paths $I \rightarrow X$ as its 1-arrows and relative homotopy classes of relative homotopies $I^2 \rightarrow X$ as 2-arrows. This last means that the homotopy of homotopies is taken through maps I^2 that are relative homotopies between the source and target map. The 2-arrows are referred to as *2-tracks*. Since concatenation of paths is not associative, but only up to homotopy, there are natural 2-arrows

$$a_{fgh}: (fg)h \Rightarrow f(gh)$$

between the two ways of performing a threefold composition. They are called the components of the *associator* of $\Pi_2(X)$. Similarly, there are natural 2-arrows expressing the homotopy invertibility and unitarity.

⁵See also [Ste00], example 8.1, where the full details are spelled out at great length.

A map $X \rightarrow Y$ of spaces induces a strict 2-functor $\Pi_2^T(X) \rightarrow \Pi_2^T(Y)$, and as one would expect, we have a functor

$$\Pi_2^T : \mathbf{Top} \rightarrow \mathbf{Bigpd}$$

from \mathbf{Top} to the category of bigroupoids and strict 2-functors.

It is the structure morphisms which we shall first consider. We first note that all homotopies discussed are relative to the endpoints of the paths involved, so we shall suppress the adjective. When one first learns about the fundamental group of a space, the proof that the multiplication is associative is usually accompanied by a picture similar to

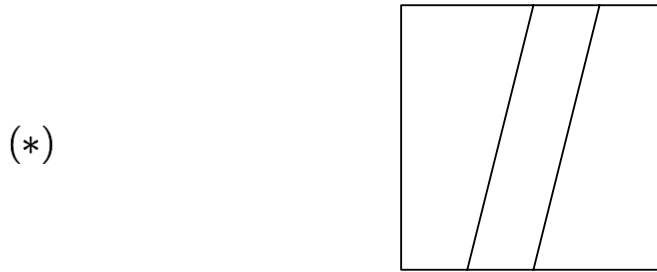

While this is meant to indicate a homotopy $I^2 \rightarrow X$ between bracketed concatenations of paths, it can be seen as simply a homotopy $h_a : I^2 \rightarrow I$ between parameterisations $I \rightarrow I$ of the interval. If we consider $I = [0, \frac{1}{3}] \cup [\frac{1}{3}, \frac{2}{3}] \cup [\frac{2}{3}, 1]$ to be a balanced concatenation of intervals, and

$$[0, \frac{1}{2}] \cup [\frac{1}{2}, \frac{3}{4}] \cup [\frac{3}{4}, 1] \quad [0, \frac{1}{4}] \cup [\frac{1}{4}, \frac{1}{2}] \cup [\frac{1}{2}, 1]$$

as bracketed concatenations, the homotopy (*) is a relative homotopy between the two PL-paths $b_{(12)3}, b_{1(23)} : I \rightarrow I$ represented by the following pictures

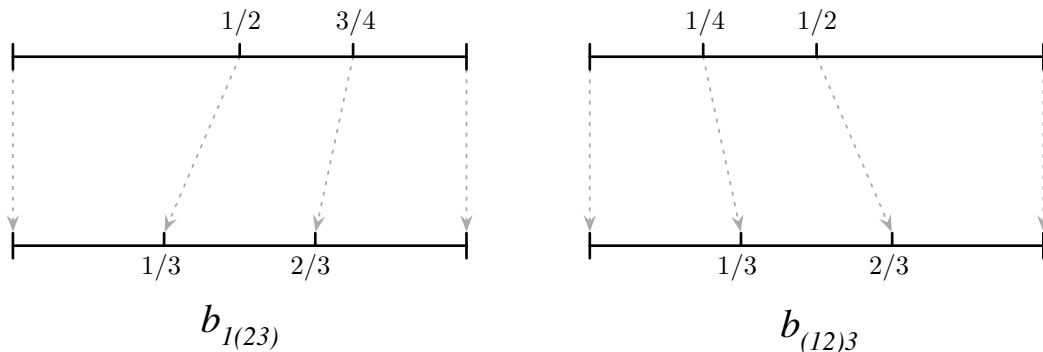

When we move to the fundamental bigroupoid this homotopy becomes a representative for the associator, and the component a_{fgh} of the associator is recovered by post-composing the h_a with the path $(f, g, h) : I \rightarrow X$, defined to be a balanced

concatenation of f , g and h :⁶

$$(f, g, h)(t) = \begin{cases} f(3t) & t \in [0, \frac{1}{3}] \\ g(3t - 1) & t \in [\frac{1}{3}, \frac{2}{3}] \\ h(3t - 2) & t \in [\frac{2}{3}, 1] \end{cases}$$

Similarly, the usual pictures that express the homotopies between concatenation of a path γ with either of the constant paths $\underline{\gamma(0)}$ or $\underline{\gamma(1)}$.

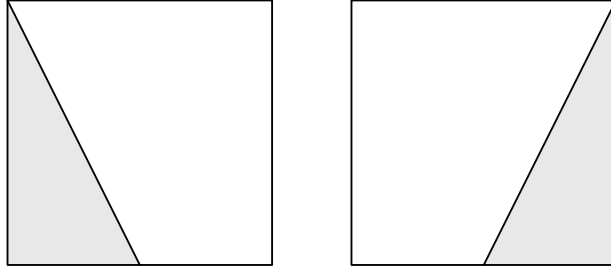

can be seen as homotopies between the identity parameterisation of I and one which is constant at an endpoint for half of I (strictly speaking we cannot call this a parameterisation, as it is degenerate). The homotopy from a path followed by its reverse to the constant path also has such an interpretation.

In this way it is easy to see that the representatives of the structural 2-arrows are *thin* homotopies: they factor through a one-dimensional space. A *thin homotopy* [HKK00] is defined to be a homotopy that factors through a finite tree T , $I^2 \rightarrow T$ (such that this map is a homotopy between PL-maps $I \rightarrow T$). Even though homotopies that factor through a path are thin, they are in a sense narrower than a general thin homotopy and so deserve a name of their own

DEFINITION 2.45. A homotopy $I^2 \rightarrow X$ in a space that factors through a path $I \rightarrow X$ will be called *very thin*.

The following examples are tautologous, but useful.

EXAMPLE 2.46. Any homotopy between paths in I is very thin.

EXAMPLE 2.47. Given a path $\gamma: I \rightarrow X$ in a space and a homotopy $h: I^2 \rightarrow I$, the composite $\gamma \circ h: I^2 \rightarrow X$ is a very thin homotopy from $\gamma \circ h(0, -)$ to $\gamma \circ h(1, -)$.

For Hausdorff spaces X , the homotopy class of a thin homotopy is determined by its source and target [HKK00]. What this means is if a pair of paths are thinly homotopic, then any other thin homotopy between them is homotopic to the original homotopy. We have a similar, almost obvious result for very thin homotopies: Given a pair of very thin homotopies $I^2 \rightarrow X$ that factor through the same path $\eta: I \rightarrow X$, there is a homotopy between them that factors through η , and so define the same 2-track. This fact, along with the Hausdorffness of I can be used to prove that the associator obeys the necessary coherence conditions, namely, the standard pentagon commutes, and similarly for the other structural 2-arrows (and this is how it is done, without much fanfare, in [HKK01]).

⁶Compare with the unbiased monoidal categories which appear in, for example [Lei03].

Now it is only the homotopy class of h_a that matters (and also for the other coherence morphisms), so we are free to replace the representative which appears in [HKK01] by an appropriately homotopic map. We define five so-called *standard homotopies* $I^2 \rightarrow I$ given by formulae (shown with regions of definition differentiated by shading) as follows.

$$h_a(s, t) = \begin{cases} \frac{4t}{3} & \text{on (1)} \\ \frac{4t}{3} & \text{on (2)} \\ \frac{2t+1}{3} & \text{on (3)} \\ \frac{4s}{3} & \text{on (4)} \\ \frac{4s-1}{3} & \text{on (5)} \\ \frac{4s-1}{6} & \text{on (6)} \\ \frac{2t}{3} & \text{on (7)} \\ \frac{4t-1}{3} & \text{on (8)} \\ \frac{4t-1}{3} & \text{on (9)} \end{cases}$$

where the subsets (1)-(9) are given by the following:

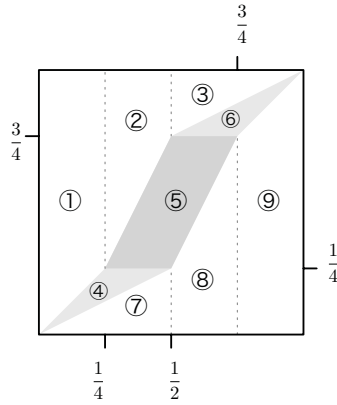

On regions (1) and (2) h_a is defined by the same equation, and similarly for regions (8) and (9). The reason they are split up is that the preimages of the intervals $[0, 1/3]$, $[1/3, 2/3]$ and $[2/3, 1]$ are the unions (1) \cup (4) \cup (7), (2) \cup (5) \cup (8) and (3) \cup (6) \cup (9) respectively. This is related to the balanced composition discussed earlier.

$$h_l(s, t) = \begin{cases} t & \text{on (1)} \\ 1 - s & \text{on (2)} \\ 2t & \text{on (3)} \end{cases}$$

where the subsets (1)-(3) are given by the following:

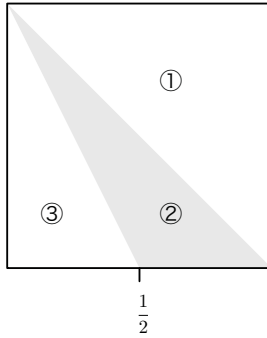

$$h_r(s, t) = \begin{cases} t & \text{on (1)} \\ s & \text{on (2)} \\ 2t - 1 & \text{on (3)} \end{cases}$$

where the subsets (1)-(3) are given by the following:

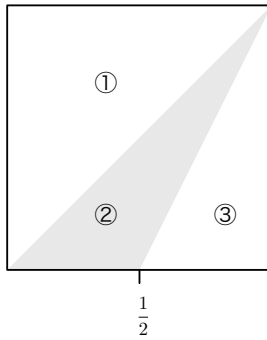

$$h_e = \begin{cases} 2t & \text{on (1)} \\ 2(1 - t) & \text{on (2)} \\ 1 - s & \text{on (3)} \end{cases}$$

where the subsets (1)-(3) are given by the following:

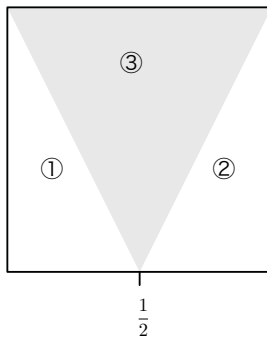

$$h_i = \begin{cases} 1 - 2t & \text{on (1)} \\ 2t - 1 & \text{on (2)} \\ 1 - s & \text{on (3)} \end{cases}$$

where the subsets (1)-(3) are given by the following:

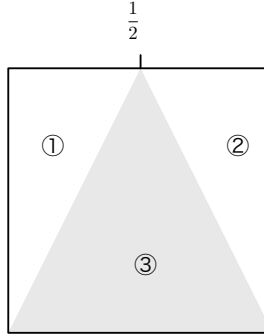

REMARK 2.48. Note that for each $s_0 \in [0, 1]$ the restriction $t \mapsto h(s_0, t)$ is a path that is constant for (s_0, t) in any shaded region, and the same is true if we consider $s \mapsto h(s, \epsilon)$, $\epsilon = 0, 1$. These five maps also have the property that the inverse image of a point in I is a finite union of lines in I^2 , each parallel to an edge of the square. Thus if we are given a picture of a partition, the inverse image of the boundaries of the regions in I by h_a, h_l, h_r, h_e or h_i defines a picture of a pre-2-partition.

DEFINITION 2.49. Homotopies $I^2 \rightarrow I$ with the property from remark 2.48 will be called *rectilinear*.

REMARK 2.50. All the rectilinear homotopies $h: I^2 \rightarrow I$ we shall have recourse to use, including the standard homotopies, satisfy $h(s, \epsilon) \in \{0, 1\} \subset I$ for $\epsilon = 0, 1$.

Notice that for a rectilinear homotopy $\tau: I^2 \rightarrow I$, all pullbacks $\tau^*\mathbf{p}$ are pre-2-partitions. However it may be the case that given a generic homotopy $\tau': I^2 \rightarrow I$, only particular partitions pull back to give pre-2-partitions. These are sometimes useful to consider, especially if \mathbf{p} is given first, but when dealing with varying partitions, rectilinear homotopies are necessary.

REMARK 2.51. The standard homotopies $h_?$ constructed above are homotopic to the usual representatives $h'_?$, which one can extract for example from [Spa66], pp 47–48, with the homotopy between them given by an affine combination, $(r, s, t) \mapsto rh_?(s, t) + (1 - r)h'_?(s, t)$.

We remark that the bigroupoid structure on Π_2^T is completely determined by formal properties of the algebra of intervals, squares, cubes and structure morphisms as sketched above. This is similar in spirit to Trimble's definition of a weak n -groupoid (called by him a *flabby* n -groupoid) [Tri99], see [Lei01, nLa09b], where the A_∞ -cocategory structure on I determines the structure of the fundamental n -groupoid $\Pi_n(X)$.

When we pass to the fundamental bigroupoid for topological groupoids, these ideas of very thin homotopies and standard homotopies will be crucial in showing

coherence. Because the domain of paths and surfaces vary, it would otherwise be difficult to define structure morphisms, let alone show they are coherent. We however will show formally that the standard homotopies are coherent for (particular) paths in partition groupoids. Post-composition with, say, balanced composition of paths in a groupoid will then show the associator coherence holds for all paths in all groupoids (and similarly for the other structure morphisms).

We now define very thin surfaces in a groupoid

DEFINITION 2.52. Let $f: \mathfrak{h} \rightarrow X$ be a surface in a groupoid. It is called *very thin* if there is a path $\gamma: \mathfrak{p} \rightarrow X$ such that f factors through γ .

We do not assume that $\mathfrak{h}|_{s=\epsilon} \simeq \mathfrak{p}$ ($\epsilon = 0, 1$).

EXAMPLE 2.53. The simple surface $I \times \mathfrak{p} \xrightarrow{\text{pr}_2} \mathfrak{p} \rightarrow X$ is very thin. Notice that $I \times \mathfrak{p}$ is the pullback $\text{pr}_2^* \mathfrak{p}$ where $\text{pr}_2: I^2 \rightarrow I$.

EXAMPLE 2.54. Let $\mathfrak{p} \rightarrow X$ be a path and $\tau: I^2 \rightarrow I$ a map such that $\tau^* \mathfrak{p} \rightarrow I^2$ is a pre-2-partition (e.g. when τ a rectilinear homotopy) and that the paths $\tau(0, -), \tau(1, -): I \rightarrow I$ are constant. Then given any improvement $\mathfrak{h} \rightarrow \tau^* \mathfrak{p}$, the composite

$$\mathfrak{h} \rightarrow \tau^* \mathfrak{p} \rightarrow \mathfrak{p} \rightarrow X$$

is a very thin surface.

This is the motivating example for the definition of very thin surface, and will essentially be the only sort we will consider.

To build up rectilinear homotopies we can paste them together. It is clear that given a region $R \subset I^2$ we can define a rectilinear ‘homotopy’

$$R \rightarrow I$$

and these can be gotten by precomposing a rectilinear homotopy by a homeomorphism $R \xrightarrow{\sim} I^2$. We can then (taking into account continuity) define a new rectilinear homotopy region by region out of old rectilinear homotopies. This is how we shall consider structure morphisms, their composites and questions of naturality.

4. 2-tracks

Now we want to define a homotopy of surfaces. Let r, s, t be coordinates on I^3 .

DEFINITION 2.55. Let γ_0, γ_1 be paths in the topological groupoid X with the same endpoints, and $f_\epsilon: \mathfrak{h}_\epsilon \rightarrow X$, $\epsilon = 0, 1$ surfaces rel endpoints between them. A *homotopy of surfaces* $f_0 \sim f_1$ is a functor

$$\mathfrak{H} \rightarrow X$$

such that the following diagrams commute;

$$(11) \quad \begin{array}{ccccc} \mathfrak{H}|_{r=0} & \hookrightarrow & \mathfrak{H} & \longleftarrow & \mathfrak{H}|_{r=1} \\ \downarrow = & & \downarrow & & \downarrow = \\ \mathfrak{h}_0 & \xrightarrow{f_0} & X & \xleftarrow{f_1} & \mathfrak{h}_1 \end{array}$$

$$(12) \quad \begin{array}{ccccc} \mathfrak{H}|_{s=0} & \hookrightarrow & \mathfrak{H} & \longleftarrow & \mathfrak{H}|_{s=1} \\ \downarrow & & \downarrow & & \downarrow \\ \mathfrak{p}_0 & \xrightarrow{\gamma_0} & X & \xleftarrow{\gamma_1} & \mathfrak{p}_1 \end{array}$$

$$(13) \quad \begin{array}{ccccc} \mathfrak{H}|_{t=0} & \hookrightarrow & \mathfrak{H} & \longleftarrow & \mathfrak{H}|_{t=1} \\ \downarrow & & \downarrow & & \downarrow \\ * & \xrightarrow{x_0} & X & \xleftarrow{x_1} & * \end{array}$$

Notice that we do *not* require that $\mathfrak{H}|_{s=\epsilon} = I \times \mathfrak{p}_\epsilon$, and indeed this 2-partition groupoid could contain many more regions than \mathfrak{p} does.

EXAMPLE 2.56. Any surface is homotopic to the surface given by precomposition with a refinement of its domain. If $f: \mathfrak{h} \rightarrow X$ is a surface, we write

$$f[\mathfrak{h}']: \mathfrak{h}' \rightarrow \mathfrak{h} \rightarrow X$$

where $\mathfrak{h}' \rightarrow \mathfrak{h}$ is a refinement. Then $f[\mathfrak{h}'] \sim f$, by the homotopy

$$\mathfrak{h}' * \mathfrak{h} \rightarrow \mathbf{2} \times \mathfrak{h} \rightarrow \mathfrak{h} \xrightarrow{f} X.$$

EXAMPLE 2.57. A *simple homotopy* is a homotopy of the form

$$I \times \mathfrak{h} \rightarrow X.$$

This should be compared to the definition of a simple surface (example 2.39).

EXAMPLE 2.58. Let $f_1, f_2: \mathfrak{h} \rightarrow X$ be surfaces, and let $a: f_1 \Rightarrow f_2$ be a natural transformation such that $a_y = \text{id}_{f_1(y)}$ for all $y \in \mathfrak{h}|_{x=\epsilon}$ with $x = s, t$ and $\epsilon = 0, 1$ – that is, on the subgroupoid $\partial I^2 \times_{I^2} \mathfrak{h}$. This automatically implies that the surfaces are between the same paths. Then there is a homotopy

$$\mathfrak{d} \times \mathfrak{h} \rightarrow \mathbf{2} \times \mathfrak{h} \xrightarrow{a} X.$$

More generally, let $f_i: \mathfrak{h}_i \rightarrow X$ be surfaces between the same paths, and let $b: f_1[\mathfrak{h}_1\mathfrak{h}_2] \Rightarrow f_2[\mathfrak{h}_1\mathfrak{h}_2]$ be a natural transformation satisfying the same condition as in the first part of the example. Then there is a homotopy

$$\mathfrak{h}_1 * \mathfrak{h}_2 \rightarrow \mathbf{2} \times \mathfrak{h}_1\mathfrak{h}_2 \xrightarrow{b} X.$$

An important application of this is as follows. Assume that we are given two surfaces f_1, f_2 which both factor through t-d groupoids $D_1, D_2 \hookrightarrow X$ which is the case if X itself is t-d, for example. Then by lemma 2.26 they both factor through tree subgroupoids $T_i \hookrightarrow X$. Assume further that they are between the same paths, so that it is meaningful to ask that there is a homotopy between them.

LEMMA 2.59. *Given the surfaces f_i as just described, there is a natural transformation $f_1[\mathfrak{h}_1\mathfrak{h}_2] \Rightarrow f_2[\mathfrak{h}_1\mathfrak{h}_2]$ and hence a homotopy between f_1 and f_2 .*

Proof. Taking a common refinement of the domains of f_1 and f_2 , we can assume that they have the same domain \mathfrak{h} . This implies that $T_1 = T_2 =: T$, but these are not necessarily equal as tree subgroupoids, as the embedding $j_1, j_2: T \hookrightarrow X$ are not equal in general. However, as T is codiscrete, we can find a natural transformation $j_1 \Rightarrow j_2$ with the property from the previous example by defining it to be the identity where it needs to be then extending uniquely by imposing naturality. Then there is a diagram

$$\begin{array}{ccc}
 & T & \\
 \nearrow & \downarrow & \searrow \\
 \mathfrak{h} & = & X \\
 \searrow & \Downarrow & \nearrow \\
 & T & \\
 & \downarrow & \\
 & & X
 \end{array}$$

to which we can apply the previous example and obtain the desired homotopy. \square

PROPOSITION 2.60. *Homotopy is an equivalence relation on the set of surfaces between a pair of paths γ_0, γ_1 with the same endpoints.*

Proof. Clearly a surface $f: \mathfrak{h} \rightarrow X$ is homotopic to itself, using the homotopy $I \times \mathfrak{h} \xrightarrow{\text{pr}} \mathfrak{h} \xrightarrow{f} X$. Let $f_0 \sim f_1$ by the homotopy $F: \mathfrak{H} \rightarrow X$. If the map $\rho: I^3 \rightarrow I^3$ is the map $(r, s, t) \mapsto (1-r, s, t)$, then the composite, then $f_1 \sim f_0$ by $\rho^* \mathfrak{H} \rightarrow \mathfrak{H} \xrightarrow{F} X$. To show that \sim is transitive, given homotopies $F_1: \mathfrak{H} \rightarrow X$ and $F_2: \mathfrak{G} \rightarrow X$ from f_1 to f_2 and from f_2 to f_3 , we define a 3-partition by the pullback

$$\begin{array}{ccc}
 \mathfrak{H} \vee_r \mathfrak{G} & \longrightarrow & \mathfrak{H} \amalg \mathfrak{G} \\
 \downarrow & & \downarrow \\
 & & I^3 \amalg I^3 \\
 \downarrow & & \downarrow \\
 I^3 & \xrightarrow[r \mapsto 2r]{\sim} & I^3 \cup_{I^2} I^3
 \end{array}$$

and $\mathfrak{H} \vee_r \mathfrak{G}$ to be the corresponding 3-partition groupoid (notice that this is not the same as the pullback of $\mathfrak{H} \amalg \mathfrak{G}$ along $(r \mapsto 2r)$ - it has more arrows). Because F_1 and F_2 agree at f_1 , we can extend $F_1 \amalg F_2$ along the indicated inclusion, sending the extra arrows to identity arrows

$$\begin{array}{ccc}
 \mathfrak{H} \amalg \mathfrak{G} & \xrightarrow{F_1 \amalg F_2} & X \\
 \downarrow & \nearrow \text{---} & \\
 \mathfrak{H} \vee_r \mathfrak{G} & &
 \end{array}$$

and so \sim is transitive. □

Notice that for all surfaces in a given equivalence class have the same restrictions to $\mathfrak{h}|_{s=0}$ and $\mathfrak{h}|_{s=1}$ (by (12)), and so we can talk about the *1-source* of an equivalence class, $s_1[f : \mathfrak{h} \rightarrow X] = f|_{\mathfrak{h}|_{s=0}}$, and the *1-target*, $t_1[f : \mathfrak{h} \rightarrow X] = f|_{\mathfrak{h}|_{s=1}}$. We also have the *0-source* $s_0[f]$ and *0-target* $t_0[f]$, which are the images of $f|_{t=0}$ and $f|_{t=1}$ respectively. These are well defined, by (13).

DEFINITION 2.61. (c.f. [HKK00]) A *2-track* in a topological groupoid X is an equivalence class $[f]$ of surfaces under the equivalence relation ‘homotopic’. If a 2-track has a representative that is a very thin surface, it will be called a *very thin 2-track*. The set of 2-tracks between γ_0 and γ_1 will be denoted $\Pi_2(X)(\gamma_0, \gamma_1)$. The set of tracks between paths that have endpoints x_0 and x_1 will be denoted $\Pi_2(X)(x_0, x_1)$.

Note that we do not assume that γ_0 and γ_1 have the same endpoints, so $\Pi_2(X)(\gamma_0, \gamma_1)$ may be empty. Also, we will blur the distinction between a 2-track $[f]$ and any representative f .

EXAMPLE 2.62. Given a functor $g: \mathcal{R} \rightarrow X$ where \mathcal{R} is a pre-2-partition groupoid, and a pair of refinements $\mathcal{R}'_1, \mathcal{R}'_2$, consider the composites

$$\begin{aligned} \mathcal{R}'_1 &\rightarrow \mathcal{R} \rightarrow X \\ \mathcal{R}'_2 &\rightarrow \mathcal{R} \rightarrow X. \end{aligned}$$

Assume that $\mathcal{R}'_i|_{s=\epsilon} \rightarrow \mathcal{R}|_{s=\epsilon}$, $\epsilon = 0, 1$, $i = 1, 2$ is the identity. If either of them are a surface, then so is the other, and they both define the same 2-track (just use the previous example).

This means that we can define a 2-track using a pre-2-partition groupoid as domain instead of a 2-partition groupoid, knowing that when the pre-2-partition is improved to a 2-partition, we still have the same 2-track no matter how this is done.

EXAMPLE 2.63. The *identity* 2-track $1_{[\gamma]}$ for a path $\gamma: \mathfrak{p} \rightarrow X$ is represented by the constant surface

$$\underline{\gamma}: I \times \mathfrak{p} \xrightarrow{\text{pr}_2} \mathfrak{p} \xrightarrow{\gamma} X$$

and is an element of $\Pi_2(X)(\gamma, \gamma)$. It is clearly very thin.

DEFINITION 2.64. Given a 2-track $[f]$ in a groupoid X , the *inverse* 2-track $-[f]$ is represented by

$$i_s^* \mathfrak{h} \rightarrow \mathfrak{h} \xrightarrow{f} X$$

where $i_s: I^2 \rightarrow I^2$ sends $(s, t) \mapsto (1 - s, t)$. If $[f] \in \Pi_2(X)(\gamma_0, \gamma_1)$, then $-[f] \in \Pi_2(X)(\gamma_1, \gamma_0)$. The *reverse* 2-track $\overline{[f]}$ is represented by

$$i_t^* \mathfrak{h} \rightarrow \mathfrak{h} \xrightarrow{f} X$$

where $i_t: I^2 \rightarrow I^2$ sends $(s, t) \mapsto (s, 1 - t)$. If $[f] \in \Pi_2(X)(x_0, x_1)$ then $\overline{[f]} \in \Pi_2(X)(x_1, x_0)$.

Clearly $-(-[f]) = [f]$ and $\overline{\overline{[f]}} = [f]$ (even at the level of surfaces). Also, the inverse of the identity 2-track is the identity 2-track. The following lemma is a straightforward verification.

LEMMA 2.65. *For a 2-track $[f]$ we have*

$$s_1(-[f]) = t_1[f], \quad t_1(-[f]) = s_1[f], \quad s_1\overline{[f]} = \overline{s_1[f]}, \quad t_1\overline{[f]} = \overline{t_1[f]}.$$

The reader will appreciate that there is not much regularity in the picture corresponding to a generic 2-partition. Since the equivalence class of a homotopy is independent of refinements of the domain 2-partition, we are free to replace the domain of a given homotopy representing a 2-track by one with a more regular picture. Ideally, we would like to have 2-partitions of the form $\mathfrak{p} \times \mathfrak{q}$, but this is not always possible without changing the source and target paths, which would give an entirely different 2-track. In general, we can find a representative of the 2-track where the domain looks like

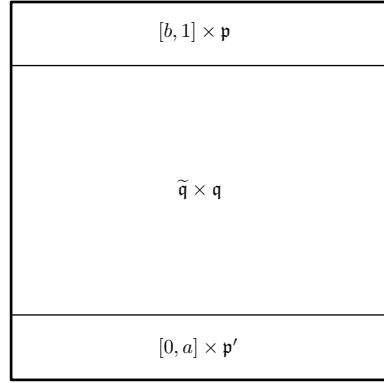

with $a < b$, $\mathfrak{q} \rightarrow \mathfrak{p}'\mathfrak{p}$ a refinement, $\tilde{\mathfrak{q}}$ a partition of $[a, b]$, and the surface is constant in the s -direction for $s \in [0, a] \cup [b, 1]$.

DEFINITION 2.66. A 2-partition of the form above, namely

$$[0, a] \times \mathfrak{p}' \amalg \tilde{\mathfrak{q}} \times \mathfrak{q} \amalg [b, 1] \times \mathfrak{p}$$

is called *almost regular*, as is the associated 2-partition groupoid.

DEFINITION 2.67. Let $f: \mathfrak{h} \rightarrow X$ be a surface in a groupoid. We say the surface has *sitting instants* if there exist $0 < a < b < 1$ such that

$$\underline{\mathfrak{h}} = [0, a] \times \mathfrak{h}|_{s=0} \amalg \tilde{\underline{\mathfrak{h}}} \amalg [b, 1] \times \mathfrak{h}|_{s=1}$$

where $\tilde{\underline{\mathfrak{h}}}$ is a 2-partition of $[a, b] \times I$, f is constant in the s -direction for $s \in [0, a^-]$ and $s \in [b^+, 1]$, and all the arrows $(a^-, a^+; t^x, t^{x'})$, $(b^-, b^+; t^x, t^{x'})$ in \mathfrak{h} are sent to identity arrows in X .

The proof of the following is safely left as an exercise to the reader, with a picture to indicate the idea

LEMMA 2.68. *Every surface is homotopic to a surface with sitting instants.*

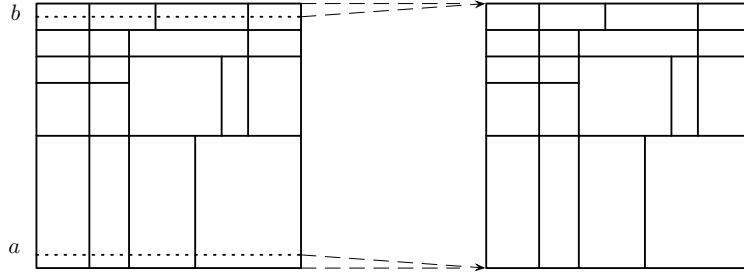

REMARK 2.69. By refining the 2-partition $\tilde{\mathfrak{h}}$ from definition 2.67 to a regular 2-partition (i.e. $\tilde{\mathfrak{q}} \times \mathfrak{p} \rightarrow \tilde{\mathfrak{h}}$) we see that every 2-track has a representative with sitting instants and with an almost regular domain. The subgroupoid $\tilde{\mathfrak{h}} \subset \mathfrak{h}$ will be called the *regular part* of \mathfrak{h} . However, we can improve this result further.

LEMMA 2.70. Let $[f]$ be a 2-track in a groupoid X , which by remark 2.69 has a representative surface $f: \mathfrak{h} \rightarrow X$ with sitting instants and an almost regular domain. Assume the partition $\mathfrak{p}_\epsilon := \mathfrak{h}|_{s=\epsilon}$ is given by $\{t_1, \dots, t_n\}$ for $\epsilon = 0$ and by $\{t'_1, \dots, t'_m\}$ for $\epsilon = 1$. Then there are numbers δ, δ' with $0 < \delta < \min(t_1, t'_1)$ and $\max(t_n, t'_m) < \delta' < 1$, and a homotopic surface $f': \mathfrak{h}' \rightarrow X$ such that f' is constant on the shaded regions in the following (partial) picture of \mathfrak{h}' :

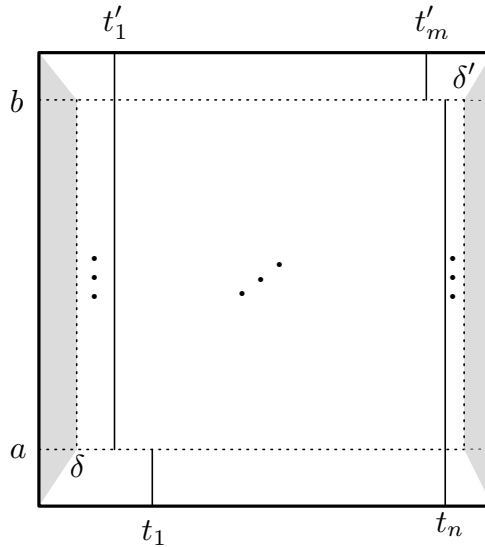

Proof. Let $T_{min} = \min(t_1, t'_1)$ and $T_{max} = \max(t_n, t'_m)$. The 2-partition \mathfrak{h}' is defined as a refinement of \mathfrak{h} by adding lines to its picture from (a, δ) to (b, δ) , and from (a, δ') to (b, δ') for $0 < \delta < T_{min} < T_{max} < \delta' < 1$. Then for coordinates (s, t) on \mathfrak{h}' , $f'(s, t) = f(s, t)$ for $(s, t) \in I \times [T_{min}^-, T_{max}^+]$. For $(s, t) \in [a^-, b^+] \times [\delta^+, T_{min}^-]$ we just have f scaled in the t -direction, and the same for $(s, t) \in [a^-, b^+] \times [T_{max}^+, \delta'^-]$. On the ‘corner’ regions, f' is defined as the usual homotopy between a path and the same path concatenated with a constant path.

This surface just outlined is homotopic to the original surface in two steps: the first homotopy arises because f' factors through \mathfrak{h} , and the second by then homotoping away the constant surfaces at the vertical boundaries. \square

As a result, any 2-track is still represented by a surface with sitting instants, and an almost regular domain, but also with sitting instants in the s -direction.

DEFINITION 2.71. A surface as in lemma 2.70 will be called *collared*. This includes the condition that the domain \mathfrak{h} of the surface is almost regular. The subgroupoid around the boundary on which the surface is constant in the inward direction will be called the *collar*. Strictly speaking, this is the pullback of $\mathfrak{h} \rightarrow I^2$ along the inclusion

$$[0, a] \times I \cup [b, 1] \times I \cup I \times [0, \delta] \cup I \times [\delta', 1] \rightarrow I^2.$$

When proving that the structure morphisms of the fundamental bigroupoid are natural, we must consider thin homotopies of surfaces. There appears to be no general definition (for spaces) of thin homotopies $I^n \times I \rightarrow X$, $n > 1$ in the literature outside of the smooth setting. However, it is clear that a homotopy $I^2 \times I \rightarrow X$ which factors through a map $I^2 \rightarrow X$ deserves to be called thin, but not all thin homotopies will be of this form. In fact, for the smooth setting there are plenty more thin homotopies than ones of this form. Generalising to all dimensions, we make the following

DEFINITION 2.72. A homotopy $I^n \times I \rightarrow X$, $n \geq 1$, between maps of spaces is *very thin* if it factorises through a map $I^n \rightarrow X$.

EXAMPLE 2.73. Let $\Sigma: I^2 \rightarrow X$ be a surface in a space X , and $\lambda: I^2 \xrightarrow{\sim} I^2$ be a reparameterisation in the s -direction. There is clearly a homotopy $h: I^2 \times I \rightarrow I^2$ between the standard parameterisation $I \xrightarrow{\cong} I$ and λ , which we can choose to be through reparameterisations in the s -direction. Then $\Sigma \circ h$ is a homotopy between Σ and $\Sigma \circ \lambda$, factorising through I^2 .

As we did for thin surfaces, we shall formulate thin homotopies of surfaces in groupoids.

DEFINITION 2.74. A homotopy $F: \mathfrak{H} \rightarrow X$ between surfaces in a groupoid is called *very thin* if there is a surface $\mathfrak{h} \rightarrow X$ such that F factors through this surface.

To give examples of very thin homotopies, we extend the definition of rectilinear homotopy to maps $I^3 \rightarrow I^2$

DEFINITION 2.75. A homotopy $I^3 \rightarrow I^2$ is called *rectilinear* if the inverse image of a picture of any 2-partition is a picture of a pre-3-partition.

Now given a surface $f: \mathfrak{h} \rightarrow X$ and a rectilinear homotopy $\tau: I^3 \rightarrow I^2$, there is a very thin homotopy

$$\mathfrak{H} \rightarrow \tau^* \mathfrak{h} \rightarrow \mathfrak{h} \xrightarrow{f} X$$

where $\mathfrak{H} \rightarrow \tau^* \mathfrak{h}$ is an improvement.

REMARK 2.76. We can use the standard homotopies $I^2 \rightarrow I$ (which are rectilinear) to define rectilinear homotopies $k: I^3 \rightarrow I^2$. For these to be used to define thin homotopies of surfaces in a groupoid the following conditions need to hold:

- (1) The restriction $k|_{s=\epsilon}: I^2 \rightarrow I^2$, $\epsilon = 0, 1$ needs to factor through either of the subspaces $\{\epsilon'\} \times I$ for $\epsilon' = 0, 1$.
- (2) The restriction $k|_{t=\epsilon}: I^2 \rightarrow I^2$, $\epsilon = 0, 1$ needs to factor through one of the subspaces $I \times \{\epsilon'\}$ for $\epsilon' = 0, 1$.

Then if $\mathfrak{h} \rightarrow X$ is a surface, and $k: I^3 \rightarrow I^2$ is a rectilinear homotopy satisfying (1) and (2), the composite

$$k^* \mathfrak{h} \rightarrow \mathfrak{h} \rightarrow X$$

is a homotopy between surfaces in X .

5. Compositions and concatenations

We now at last come to defining the ways in which 2-tracks (which will be 2-arrows in our fundamental bicategory) can be composed. First we consider general n -partitions.

DEFINITION 2.77. Let \mathcal{R}_1 and \mathcal{R}_2 be n -partitions, and let x_1, \dots, x_n be coordinates on I^n . The *amalgamation in the x_i -direction* is the pullback

$$\begin{array}{ccc} \mathcal{R}_1 \vee_{t_i} \mathcal{R}_2 & \longrightarrow & \mathcal{R}_1 \amalg \mathcal{R}_2 \\ \downarrow & & \downarrow \\ I^n & \xrightarrow[\sim]{x_i \mapsto 2x_i} & I^n \cup_{I^{n-1}} I^n \end{array}$$

When $n = 1$, the amalgamation of \mathfrak{p} and \mathfrak{q} (there is only one!) looks like

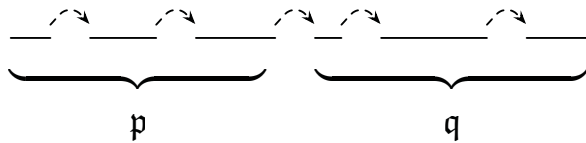

When $n = 2$, amalgamation in the s -direction looks like this

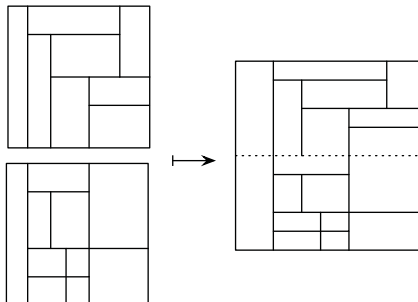

and amalgamation in the t -direction looks like this

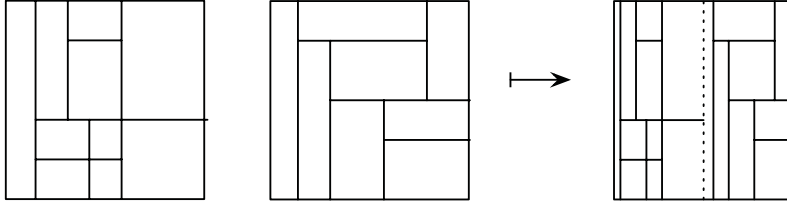

The n -partition groupoid corresponding to $\underline{\mathcal{R}}_1 \vee_{x_i} \underline{\mathcal{R}}_2$ will be denoted by $\mathcal{R}_1 \vee_{x_i} \mathcal{R}_2$. There is a square

$$\begin{array}{ccc}
 \mathcal{R}_1|_{x_i=1} \mathcal{R}_2|_{x_i=0} & \longrightarrow & \mathcal{R}_2 \\
 \downarrow & \searrow & \downarrow \\
 \mathcal{R}_1 & \longrightarrow & \mathcal{R}_1 \vee_{x_i} \mathcal{R}_2
 \end{array}$$

which is a weak pushout in TG . It will often be the case that $\mathcal{R}_1|_{x_i=1} = \mathcal{R}_2|_{x_i=0}$.

LEMMA 2.78. *If we have a commuting square*

$$\begin{array}{ccc}
 \mathcal{R}_1|_{x_i=1} \mathcal{R}_2|_{x_i=0} & \longrightarrow & \mathcal{R}_2 \\
 \downarrow & & \downarrow b \\
 \mathcal{R}_1 & \xrightarrow{a} & X
 \end{array}$$

for some groupoid X , there is a unique functor $p: \mathcal{R}_1 \vee_{x_i} \mathcal{R}_2 \rightarrow X$ such that on the subgroupoid $\mathcal{R}_1 \amalg \mathcal{R}_2 \hookrightarrow \mathcal{R}_1 \vee_{x_i} \mathcal{R}_2$, p agrees with $a \amalg b$, and the arrows in $\mathcal{R}_1 \vee_{x_i} \mathcal{R}_2$ which go from objects in \mathcal{R}_1 to objects in \mathcal{R}_2 (or vice versa) are sent to identity arrows in X .

We pause briefly to define balanced composition and concatenation, which will be used in the proofs of associativity and weak associativity over the next few pages. Ordinary composition and concatenation will be taken as a special case, namely $m = 2$. Even though we shall define these operations for general m , we shall only use $m = 2, 3, 4$. We start with the operation of amalgamation on n -partitions where as usual x_1, \dots, x_n are coordinates on I^n .

DEFINITION 2.79. Let $\underline{\mathcal{R}}_1, \dots, \underline{\mathcal{R}}_m$ be n -partitions. The *balanced amalgamation in the x_i direction*, $i = 1, \dots, n$ is the pullback

$$\begin{array}{ccc} \bigvee_{x_i} (\underline{\mathcal{R}}_1, \dots, \underline{\mathcal{R}}_m) & \longrightarrow & \underline{\mathcal{R}}_1 \amalg \dots \amalg \underline{\mathcal{R}}_m \\ \downarrow & & \downarrow \\ I^n & \xrightarrow{x_i \mapsto mx_i} & I^n \amalg_{I^{n-1}} \dots \amalg_{I^{n-1}} I^n \end{array}$$

The associated n -partition groupoid will be denoted $\bigvee_{x_i} (\underline{\mathcal{R}}_1, \dots, \underline{\mathcal{R}}_m)$. As in the case of 2-ary amalgamation, this is a weak colimit.

DEFINITION 2.80. Let $f_i: \mathfrak{h}_i \rightarrow X$, $i = 1, \dots, m$ be surfaces such that $t_1(f_i) = s_1(f_{i+1})$ (and so $\mathfrak{h}_i|_{s=1} = \mathfrak{g}_{i+1}|_{s=0} =: \mathfrak{p}_i$). The m -ary *composition* $+(f_m, \dots, f_1)$ is the surface

$$+(f_m, \dots, f_1): \bigvee_s (\mathfrak{h}_1, \dots, \mathfrak{h}_m) \rightarrow X$$

which is defined as the functor arising along the same lines as lemma 2.78

The binary composition $+(f, g)$ will of course be written $f+g$.⁷ The composition of 2-tracks is defined if the composition of any of their representatives are, and $[f] + [g]$ is defined to be $[f+g]$. Here is a picture of the composite of a pair of surfaces

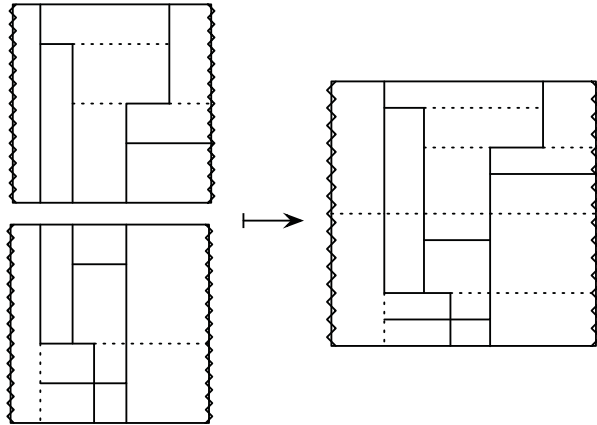

Since not all paths have the same domain, to see if surfaces (and hence 2-tracks) are composable it is easiest to check first whether the domains of the source and target match first, then worry about whether the paths are the same.

⁷Of course it is not necessarily the case that both $f+g$ and $g+f$ are defined, but the second homotopy group is built out of surfaces (see definition 2.105), and this is abelian as usual.

LEMMA 2.81. For all 2-tracks $[f], [g]$ we have

$$-([f] + [g]) = -[g] + (-[f]).$$

Proof. If the domains of g and f are \mathfrak{h} and \mathfrak{g} respectively, it is easy to see

$$i_s^*(\mathfrak{h} \vee_s \mathfrak{g}) = i_s^*\mathfrak{g} \vee_s i_s^*\mathfrak{h}.$$

That is, the amalgamation of the two surfaces in the s -direction commutes with the operation of flipping surfaces in the s -direction. After that, the result follows. \square

PROPOSITION 2.82. With composition of 2-tracks as defined, $\Pi_2(X)(x_0, x_1)$ is a groupoid.

We break the proof down into a series of lemmas.

LEMMA 2.83. The identity 2-track is a identity for composition of 2-tracks.

Proof. Consider the rectilinear homotopies

$$\begin{aligned} u_l &:= h_l \times \text{id}_I: I^3 \rightarrow I^2 \\ &(r, s, t) \mapsto (h_l(r, s), t) \\ u_r &:= h_r \times \text{id}_I: I^3 \rightarrow I^2 \\ &(r, s, t) \mapsto (h_r(r, s), t) \end{aligned}$$

It is easy to check that that u_l and u_r satisfy the conditions in remark 2.76. Then for a 2-track in X represented by a surface $f: \mathfrak{h} \rightarrow X$ let $f_\epsilon = f|_{s=\epsilon}$. There are very thin homotopies

$$\overline{u}_l: u_l^*\mathfrak{h} \rightarrow \mathfrak{h} \rightarrow X, \quad \overline{u}_r: u_r^*\mathfrak{h} \rightarrow \mathfrak{h} \rightarrow X.$$

(we have suppressed the improvements to the pre-3-partitions) giving us homotopies $\underline{f}_0 + f \sim f$ and $f + \underline{f}_1 \sim f$ of surfaces, and hence equalities $1_{s_1[f]} + [f] = [f]$ and $[f] + 1_{t_1[f]} = [f]$. \square

It is instructive to visualise what $u_l^*\mathfrak{h}$ looks like ($u_r^*\mathfrak{h}$ is the same, only flipped in the vertical direction). Consider a single region R of $\underline{\mathfrak{h}}$

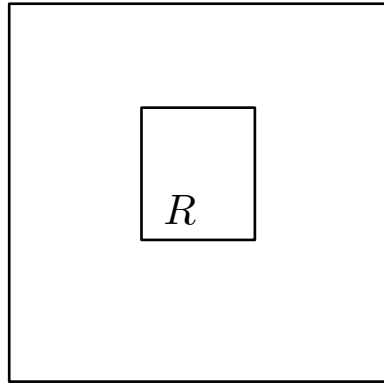

where the boundaries of the other regions are hidden. Then the rectilinear region of $u_l^*\mathfrak{h}$ mapping to R looks like

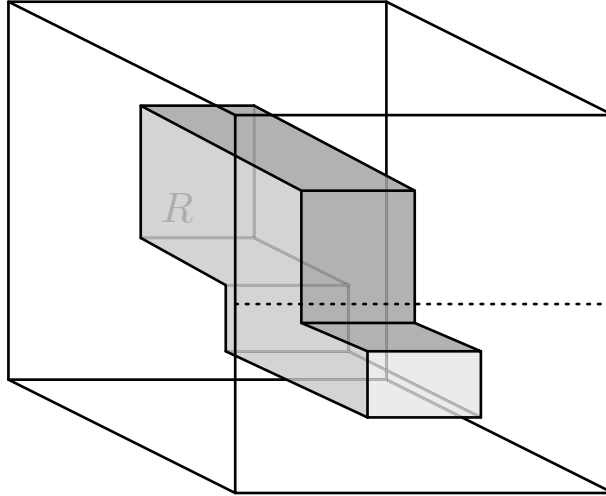

This illustrates the general approach we will take to constructing homotopies of surfaces, especially when considering questions of naturality. The boundary of the three-dimensional rectilinear region generated from R can be considered as a rectilinear extrusion of the boundary of R , shaped so as to connect what R looks like under one operation (here composition with a constant surface) to what it looks like under another operation (here the identity operation). When we consider all the regions, their extrusions fit together, or to put it another way, the extrusion of each edge does not cross the extrusion of any other edge.

LEMMA 2.84. *Composition of 2-tracks is associative.*

Proof. Consider the rectilinear homotopy

$$a := h_a \times \text{id}_I: I^3 \rightarrow I^2$$

$$(r, s, t) \mapsto (h_a(r, s), t).$$

This satisfies the conditions of remark 2.76. Let $f_i: \mathfrak{h}_i \rightarrow X$, $i = 1, 2, 3$ be surface such that the composites $f_1 + f_2$ and $f_2 + f_3$ are defined. Let $\mathfrak{h}_{123} := \bigvee_s(\mathfrak{h}_1, \mathfrak{h}_2, \mathfrak{h}_3)$. Given the balanced composition $+(f_1, f_2, f_3): \mathfrak{h}_{123} \rightarrow X$ as defined above, we have a homotopy

$$\bar{a}: a^* \mathfrak{h}_{123} \rightarrow \mathfrak{h}_{123} \rightarrow X$$

where

$$\bar{a}|_{r=0} = f_3 + (f_2 + f_1)$$

and

$$\bar{a}|_{r=1} = (f_3 + f_2) + f_1.$$

Hence $(f_1 + f_2) + f_3 \sim f_1 + (f_2 + f_3)$, and composition is associative. \square

The previous two lemmas give us the result that $\Pi_2(X)(x_0, x_1)$ is a category.

LEMMA 2.85. *The category $\Pi_2(X)(x_0, x_1)$ is a groupoid, where the inverse of $[f]$ is $-[f]$.*

Proof. By lemma 2.81 and the fact that inversion is an involution we only need to show that $[f] + (-[f]) = 1_{s_1[f]}$ for any 2-track represented by a surface $f: \mathfrak{h} \rightarrow X$. Given the 3-partition groupoid and the homotopy, we just need to flip the coordinate s and this will give $-[f] + [f] = 1_{t_1[f]}$. The homotopy

$$e := h_e \times \text{id}_I: I^3 \rightarrow I^2$$

$$(r, s, t) \mapsto (h_e(r, s), t)$$

is rectilinear and satisfies the conditions of remark 2.76. We then have a homotopy

$$\bar{e}: e^* \mathfrak{h} \rightarrow \mathfrak{h} \rightarrow X$$

where $\bar{e}|_{r=0} = f + (-f)$ and $\bar{e}|_{r=1}$ is the constant surface at $s_1[f]$. Thus $-[f]$ is the inverse of $[f]$ in $\Pi_2(X)(x_0, x_1)$. \square

DEFINITION 2.86. Let X be a topological groupoid. Define the (t-d) groupoid

$$\underline{\Pi}_2(X)_1 := \coprod_{x_0, x_1 \in X_0} \Pi_2(X)(x_0, x_1)$$

called the *groupoid of 2-tracks*. There is a functor

$$(s_0, t_0): \underline{\Pi}_2(X)_1 \rightarrow \text{disc}(X_0^\delta \times X_0^\delta)$$

sending objects and morphisms of $\Pi_2(x_0, x_1)$ to (x_0, x_1) (where of course we have stripped X_0 of its now superfluous topology).

6. The fundamental bigroupoid

We now have the beginning of what looks like a bigroupoid, namely a set X_0^δ and a (t-d) groupoid $\underline{\Pi}_2(X)_1$ over $\text{disc}(X_0^\delta \times X_0^\delta)$. As the reader might have suspected, concatenation of paths and surfaces furnishes us with a functor.

DEFINITION 2.87. Let $g_i: \mathcal{R}_i \rightarrow X$ be a pair of either surfaces or paths such that $t_0(g_1) = s_0(g_2)$. The *concatenation* $g_2 \cdot g_1$ is the path or surface given by the functor

$$\mathcal{R}_1 \vee_t \mathcal{R}_2 \rightarrow X$$

from lemma 2.78.

This models horizontal pasting of globular surfaces, such as in the picture

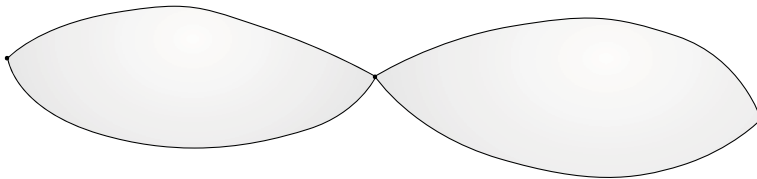

Unlike composition of surfaces, where we demand the 1-source and target have matching domains, the structure of the domains along the pasted vertical edge do not have to match. Define the pullback

$$\begin{array}{ccc}
 \underline{\Pi_2(X)_1} \times_{X_0} \underline{\Pi_2(X)_1} & \longrightarrow & \underline{\Pi_2(X)_1} \\
 \downarrow & & \downarrow t_0 \\
 \underline{\Pi_2(X)_1} & \xrightarrow{s_0} & \text{disc}(X_0^\delta)
 \end{array}$$

PROPOSITION 2.88. *Concatenation is a functor*

$$- \cdot - : \underline{\Pi_2(X)_1} \times_{X_0} \underline{\Pi_2(X)_1} \rightarrow \underline{\Pi_2(X)_1}$$

commuting with the obvious projections to $\text{disc}(X_0^\delta \times X_0^\delta)$.

Proof. Firstly, it is clear that $- \cdot -$ preserves source, target and identities – we just need to show that it preserves composition. Let \mathfrak{h}_i , $i = 1, \dots, 4$ be 2-partition groupoids such that $t_1(\mathfrak{h}_1) = s_1(\mathfrak{h}_3)$ and $t_1(\mathfrak{h}_2) = s_1(\mathfrak{h}_4)$. It is obvious there is an equality

$$(\mathfrak{h}_1 \vee_t \mathfrak{h}_2) \vee_s (\mathfrak{h}_3 \vee_t \mathfrak{h}_4) = (\mathfrak{h}_1 \vee_s \mathfrak{h}_3) \vee_t (\mathfrak{h}_2 \vee_s \mathfrak{h}_4),$$

the resulting 2-partition looking like

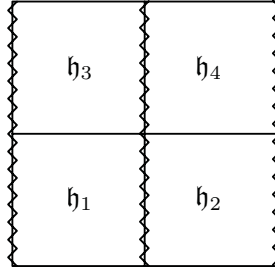

Then repeated applications of lemma 2.78 show that given representatives $f_i: \mathfrak{h}_i \rightarrow X$ of 2-tracks with $t_1(f_1) = s_1(f_3)$ and $t_1(f_2) = s_1(f_4)$ we have a well-defined surface

$$(f_2 + f_4) \cdot (f_1 + f_3) = (f_2 \cdot f_1) + (f_4 \cdot f_3): (\mathfrak{h}_1 \vee_t \mathfrak{h}_2) \vee_s (\mathfrak{h}_3 \vee_t \mathfrak{h}_4) \rightarrow X.$$

If we replace the f_i by homotopic surfaces f'_i , we can form the four-fold, two-way amalgamation of the domains of the homotopies in an unambiguous way, providing a homotopy between $(f_2 + f_4) \cdot (f_1 + f_3)$ and $(f'_2 + f'_4) \cdot (f'_1 + f'_3)$. Thus we have the exchange law for 2-tracks. \square

As we had for composition, we can define balanced concatenation in precisely the same way

DEFINITION 2.89. Given paths for surfaces $g_i: \mathcal{R}_i \rightarrow X$, $i = 1, \dots, m$, such that $t_0(g_i) = s_0(g_{i+1})$, their m -ary concatenation is the unique map

$$(g_m, \dots, g_1): \bigvee_t (\mathcal{R}_1, \dots, \mathcal{R}_m) \rightarrow X$$

arising in the same way as in lemma 2.78.

We now at last can describe the structural maps of our putative bigroupoid. For a moment just consider the domains of paths.

For partition groupoids $\mathfrak{p}_1, \mathfrak{p}_2, \mathfrak{p}_3$, we have a pre-2-partition groupoid

$$a'(\mathfrak{p}_1, \mathfrak{p}_2, \mathfrak{p}_3) = h_a^* \bigvee_t (\mathfrak{p}_1, \mathfrak{p}_2, \mathfrak{p}_3)$$

which looks something like

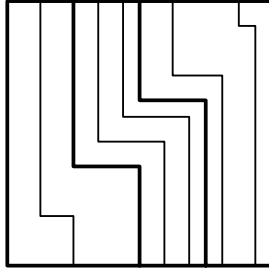

which can be improved to a 2-partition groupoid $a(\mathfrak{p}_1, \mathfrak{p}_2, \mathfrak{p}_3)$, like this

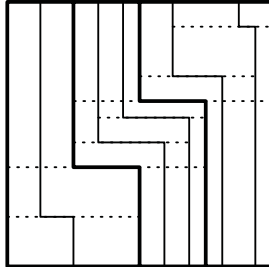

for example. The bold lines indicate the preimage of the boundaries of the original partitions in the balanced amalgamation.

DEFINITION 2.90. For paths $\gamma_i: \mathfrak{p}_i \rightarrow X$, $i = 1, 2, 3$, such that $t_0(\gamma_1) = s_0(\gamma_2)$ and $t_0(\gamma_2) = s_0(\gamma_3)$, the associator $a_{\gamma_1, \gamma_2, \gamma_3}$ is the very thin 2-track represented by

$$a(\mathfrak{p}_1, \mathfrak{p}_2, \mathfrak{p}_3) \rightarrow \bigvee_t (\mathfrak{p}_1, \mathfrak{p}_2, \mathfrak{p}_3) \xrightarrow{(\gamma_3, \gamma_2, \gamma_1)} X.$$

This 2-track does not depend on the choice of the refinement $a(\mathfrak{p}_1, \mathfrak{p}_2, \mathfrak{p}_3)$, by example 2.62.

COROLLARY 2.91. Concatenation of paths is associative up to isomorphism:

$$a_{\gamma_1, \gamma_2, \gamma_3} \cdot (\gamma_3 \cdot \gamma_2) \cdot \gamma_1 \Rightarrow \gamma_3 \cdot (\gamma_2 \cdot \gamma_1).$$

We shall soon show that this 2-arrow is natural.

Given any partition groupoid \mathfrak{p} there are pre-2-partition groupoids

$$l'(\mathfrak{p}) = h_l^* \mathfrak{p} \quad \text{and} \quad r'(\mathfrak{p}) = h_r^* \mathfrak{p}$$

which look something like

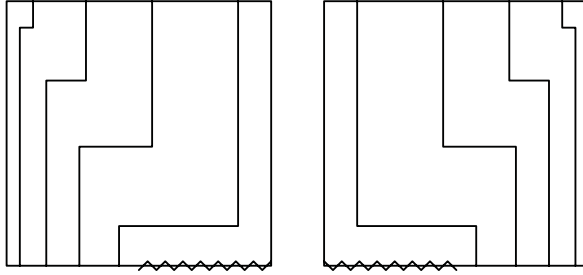

which can be refined to 2-partition groupoids $l(\mathfrak{p}), r(\mathfrak{p})$, like these

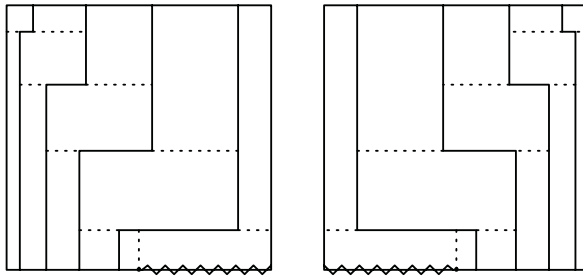

for example. So that the 1-source and 1-target of our unitors (defined shortly) are correct, we have added an arrow at $(0, \frac{1}{2})$ (i.e. in the middle of the bottom edge) to both of these.

DEFINITION 2.92. For a path $\gamma: \mathfrak{p} \rightarrow X$, the *left* and *right unitors*, l_γ and r_γ respectively, are the very thin 2-tracks represented by

$$l(\mathfrak{p}) \rightarrow \mathfrak{p} \xrightarrow{\gamma} X$$

$$r(\mathfrak{p}) \rightarrow \mathfrak{p} \xrightarrow{\gamma} X$$

COROLLARY 2.93. *The constant path $\underline{s_0(\gamma)}$ is a right unit of γ up to isomorphism for concatenation, and the constant path $\underline{t_0(\gamma)}$ is a left unit up to isomorphism.*

Given a partition groupoid \mathfrak{p} , there are pre-2-partition groupoids

$$i'(\mathfrak{p}) = h_i^* \mathfrak{p} \quad \text{and} \quad e'(\mathfrak{p}) = h_e^* \mathfrak{p}$$

which look something like

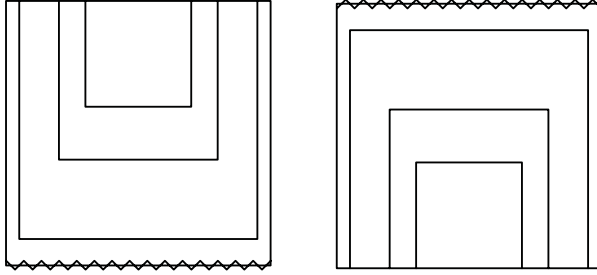

which can be refined to 2-partition groupoids $i(\mathbf{p}), e(\mathbf{p})$, like these

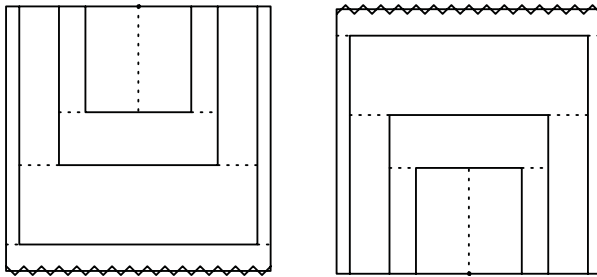

for example. So that the 1-source and 1-target of our unit and counit (defined shortly) are correct, we have added an arrow at $(1, \frac{1}{2})$ in $i(\mathbf{p})$ (i.e. in the middle of the top edge) and an arrow at $(0, \frac{1}{2})$ in $e(\mathbf{p})$ (i.e. in the middle of the bottom edge).

DEFINITION 2.94. For a path $\gamma: \mathbf{p} \rightarrow X$, the *unit* and *counit*, i_γ and e_γ respectively, are the very thin 2-tracks represented by

$$\begin{aligned} i(\mathbf{p}) &\rightarrow \mathbf{p} \xrightarrow{\gamma} X \\ e(\mathbf{p}) &\rightarrow \mathbf{p} \xrightarrow{\gamma} X \end{aligned}$$

COROLLARY 2.95. For any path γ the reverse path $\bar{\gamma}$ is an inverse up to an isomorphism for concatenation.

REMARK 2.96. It is no mistake that the pictures corresponding to the domains of the unit and counit look like copies of the unit and counit that appear in string diagrams (for a good introduction, see [BL04], where they are used extensively for 2-groups). While string diagrams are usually defined as being the Poincare duals to the usual 2-categorical diagrams, they can be interpreted as weak 2-functors from a 2-partition groupoid to a bicategory.

We shall refer to the 2-tracks $a_{\gamma_1, \gamma_2, \gamma_3}$, l_γ , r_γ , i_γ and e_γ as *structure morphisms*. We now need to show that they are natural, in the sense that given 2-tracks

$$[f_1]: \gamma_1 \Rightarrow \eta_1, [f_2]: \gamma_2 \Rightarrow \eta_2, [f_3]: \gamma_3 \Rightarrow \eta_3$$

with $s_0(\gamma_1) = x_0$ and $t_0(\gamma_1) = x_1$, we have the equalities

$$\begin{aligned}
a_{\gamma_1, \gamma_2, \gamma_3} + ([f_1] \cdot [f_2]) \cdot [f_3] &= [f_1] \cdot ([f_2] \cdot [f_3]) + a_{\eta_1, \eta_2, \eta_3}, \\
l_{\eta_1} + (I_{\underline{x}_1} \cdot [f_1]) &= [f_1] + l_{\gamma_1}, \\
r_{eta_1} + ([f_1] \cdot I_{\underline{x}_0}) &= [f_1] + r_{\gamma_1}, \\
e_{\eta_1} + ([f_1] \cdot \overline{[f_1]}) &= I_{\underline{x}_1} + e_{\gamma_1} = e_{\gamma_1}, \\
(\overline{[f_1]} \cdot [f_1]) + i_{\gamma_1} &= i_{\eta_1} + I_{\underline{x}_0} = i_{\eta_1}.
\end{aligned}$$

Let $h: I^2 \rightarrow I$ be a rectilinear homotopy satisfying the condition from remark 2.50, and define $h_\epsilon = h(\epsilon, -): I \rightarrow I$, $\epsilon = 0, 1$. In practice, h will be one of the standard homotopies h_γ from section 3. Notice that h_ϵ in that case gives rise to an operation on (possibly a number of) paths,

$$(\gamma: \mathfrak{p} \rightarrow X) \mapsto (h_\epsilon^* \mathfrak{p} \rightarrow X)$$

such as three-fold concatenation, bracketed in one way or the other (using the 3-ary concatenation $\gamma = (\gamma_3, \gamma_2, \gamma_1)$), or concatenating a path with the reverse path, or concatenating a path with a constant path. In one case we have the operation which just returns the original path, and in another we have the operation which returns the constant path at one of the endpoints of the original path. Then the map $\text{id} \times h_\epsilon: I^2 \rightarrow I^2$ gives rise to the analogous operation on surfaces: three-fold concatenation, concatenation with the reverse path, concatenation with the constant surface on the constant path etc. For a 2-partition groupoid \mathfrak{h} , denote by \mathfrak{h}_ϵ the pullback $(\text{id} \times h_\epsilon) * \mathfrak{h}$. This is the domain of the surface resulting from one of these operations.

Define the map $k: I^3 \rightarrow I^2$ by

$$k(r, s, t) = \begin{cases} (2s, h_0(t)) & r \leq s/2 \\ (r, h(2s - r, t)) & s/2 \leq r \leq (s - 1)/2 \\ (2s - 1, h_1(t)) & r \geq (s - 1)/2 \end{cases}$$

and let

$$\begin{aligned}
a &= \{(r, s, t) | r \leq s/2\} \\
b &= \{(r, s, t) | s/2 \leq r \leq (s - 1)/2\} \\
c &= \{(r, s, t) | r \geq (s - 1)/2\}
\end{aligned}$$

as in the following picture

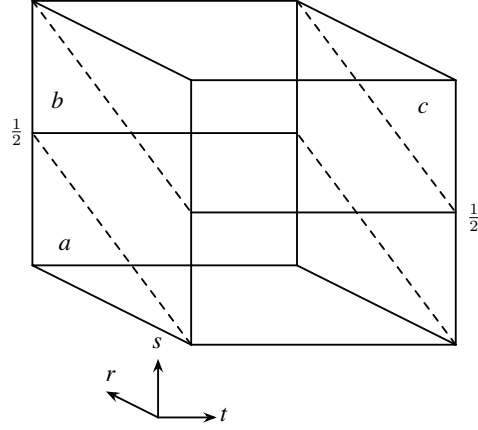

We check that k satisfies the conditions of remark 2.76. Condition (1) is obvious:

$$k(r, \epsilon, t) = (\epsilon, h_0(t))$$

and for condition (2)

$$k(r, s, \epsilon) = \begin{cases} (2s, h_0(\epsilon)) = (2s, h(0, \epsilon)) & (r, s, t) \in a \\ (r, h(2s - r, \epsilon)) & (r, s, t) \in b \\ (2s - 1, h_1(\epsilon)) = (2s - 1, h(1, \epsilon)) & (r, s, t) \in c \end{cases}$$

we use the fact that h satisfies $h(s, \epsilon) \in \{0, 1\}$. Thus given a surface $\mathfrak{h} \rightarrow X$,

$$(14) \quad k^*\mathfrak{h} \rightarrow \mathfrak{h} \rightarrow X$$

is a very thin homotopy (we have neglected to specify an improvement of the domain). We now need to identify the domains of the two homotopic surfaces, that is, the pullbacks

$$k^*\mathfrak{h}|_{r=0} \quad \text{and} \quad k^*\mathfrak{h}|_{r=1}.$$

Let

$$\begin{aligned} a' &= \{(r, s, t) \in a | r = 1\}, \\ b'_\epsilon &= \{(r, s, t) \in b | r = \epsilon, \epsilon = 0, 1\}, \\ c' &= \{(r, s, t) \in c | r = 0\}, \end{aligned}$$

and consider for now the pullbacks $(k|_x)^*\mathfrak{h}$ where x is one of a', b'_0, b'_1, c' . These are the subgroupoids of $k^*\mathfrak{h}$ corresponding to the top/bottom halves of the front and back faces of I^3 . From the definition of k , it is easy to see that up to a scaling of $1/2$ in the s -direction we have

$$\begin{aligned} (k|_{a'})^*\mathfrak{h} &= \mathfrak{h}_0, \\ (k|_{b'_0})^*\mathfrak{h} &= h^*(\mathfrak{h}|_{s=0}), \\ (k|_{b'_1})^*\mathfrak{h} &= h^*(\mathfrak{h}|_{s=1}), \\ (k|_{c'})^*\mathfrak{h} &= \mathfrak{h}_1. \end{aligned}$$

For h one of the standard homotopies, and a surface $\mathfrak{h} \rightarrow X$, the induced maps $h^*(\mathfrak{h}|_{s=\epsilon}) \rightarrow \mathfrak{h}|_{s=\epsilon} \rightarrow X$ are precisely the structure morphisms. In addition, the 2-partition groupoids $k^*\mathfrak{h}|_{r=0}, k^*\mathfrak{h}|_{r=1}$ are very nearly the amalgamations $h^*(\mathfrak{h}|_{s=0}) \vee_s \mathfrak{h}_0$ and $\mathfrak{h}_1 \vee_s h^*(\mathfrak{h}|_{s=1})$ respectively, but there is not the arrows at $s = 1/2$ that the amalgamations have. What we do have is

$$\begin{aligned} (\mathfrak{d} \times I)(k^*\mathfrak{h}|_{r=0}) &= h^*(\mathfrak{h}|_{s=0}) \vee_s (\text{id} \times h_0)^*\mathfrak{h} \\ (\mathfrak{d} \times I)(k^*\mathfrak{h}|_{r=1}) &= (\text{id} \times h_1)^*\mathfrak{h} \vee_s h^*(\mathfrak{h}|_{s=1}). \end{aligned}$$

The reason for the common refinement involving $\mathfrak{d} \times I$ is the same reason we add arrows when we define the domains of the structure morphisms. In fact, the very thin homotopy (14) is insensitive to the presence or absence of the arrows introduced by the $\mathfrak{d} \times I$ factor. This is because the 2-tracks which correspond to restricting to the $r = 0, 1$ faces are the same whether the $\mathfrak{d} \times I$ factor is present in the domain or not, by example 2.56.

Thus $k^*\mathfrak{h}$ gives us, for h one of the standard homotopies, the domain of a very thin homotopy encoding the naturality we are after.

LEMMA 2.97. *The associator, the left and right unitors, the unit and the counit are natural.*

EXAMPLE 2.98. Let $\mathfrak{h} = \bigvee_t(\mathfrak{h}_1, \mathfrak{h}_2, \mathfrak{h}_3)$ and $h = h_a$. Then

$$\begin{aligned} (\text{id} \times h_1)^*\mathfrak{h} &= \mathfrak{h}_1 \vee_t (\mathfrak{h}_2 \vee_t \mathfrak{h}_3), \\ (\text{id} \times h_0)^*\mathfrak{h} &= (\mathfrak{h}_1 \vee_t \mathfrak{h}_2) \vee_t \mathfrak{h}_3 \end{aligned}$$

and

$$\begin{aligned} h^*(\mathfrak{h}|_{s=0}) &= a'(\mathfrak{h}_1|_{s=0}, \mathfrak{h}_2|_{s=0}, \mathfrak{h}_3|_{s=0}) \\ h^*(\mathfrak{h}|_{s=1}) &= a'(\mathfrak{h}_1|_{s=1}, \mathfrak{h}_2|_{s=1}, \mathfrak{h}_3|_{s=1}). \end{aligned}$$

If we consider a region in I^2 and its preimage under k , it would look something like this

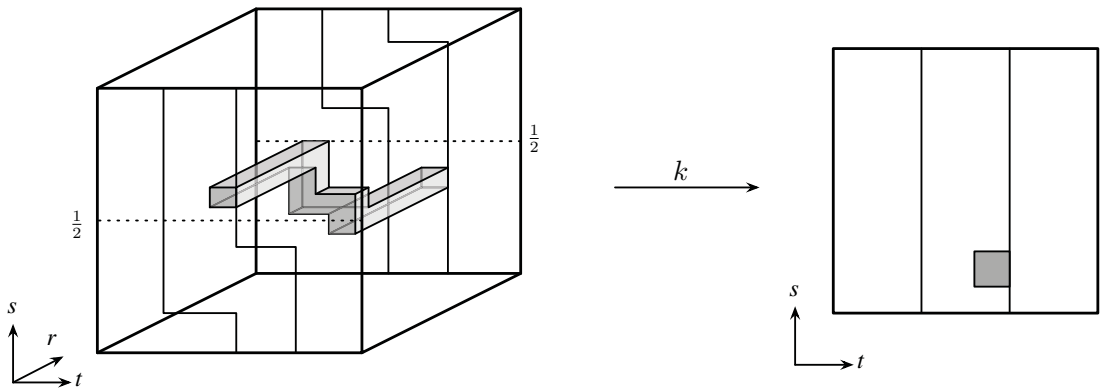

One can see that given a 2-partition, I^3 will be covered by rectilinear regions of this form, giving us a pre-3-partition, hence providing us with a domain for a homotopy.

LEMMA 2.99. *The assignment of the reverse path/2-track is a functor*

$$\overline{(-)}: \Pi_2(X)(x_0, x_1) \rightarrow \Pi_2(X)(x_1, x_0).$$

Proof. Source, target and identities are clearly preserved. Since $i_t^*(\mathfrak{h}_1 \vee_s \mathfrak{h}_2) = i_t^*\mathfrak{h}_1 \vee_s i_t^*\mathfrak{h}_2$, we apply lemma 2.78 to get that $\overline{[f_1 + f_2]} = \overline{[f_1]} + \overline{[f_2]}$. \square

PROPOSITION 2.100. $\Pi_2(X)$ *is a bigroupoid.*

Proof. All we need to show is that the various coherence diagrams from the appendix commute. Recall from section 3 that for the usual fundamental bigroupoid of spaces this was proved by noticing that every structure morphism is very thin. The coherence equation ends up as the condition that a pair of maps $I^2 \rightarrow I$ are homotopic, but this is true almost by inspection (modulo a little care about endpoints). We can assume that the structure morphisms for $\Pi_2^T(X)$ have been represented using our standard homotopies, as per remark 2.51. Then a coherence condition being satisfied is essentially the fact there is a (relative) homotopy

$$h_{coh}: I^3 \rightarrow I$$

from the map $I^2 \rightarrow I$ encoding the composite one way around the coherence diagram to the map encoding the other way around the coherence diagram. For example, associator coherence takes $I = [0, \frac{1}{4}] \cup [\frac{1}{4}, \frac{1}{2}] \cup [\frac{1}{2}, \frac{3}{4}] \cup [\frac{3}{4}, 1]$ as the balanced 4-ary concatenation of the interval, and h_{coh} as a homotopy between various pastings of h_a specified by the usual pentagon. It is possible to work out the maps h_{coh} explicitly (as formulas in coordinates on cubes), but we shall take a more intuitive, graphical approach to describing them.⁸ This is why the conceptual approach of [HKK01] was used to describe $\Pi_2^T(X)$. However, the surfaces $I^2 \rightarrow I$ that represent the composites each way around the coherence diagrams will be given in equational form, as they are (a little) simpler than one might first suppose.

First, a quick sketch of the graphical reasoning that goes with the so-called standard homotopies from section 3. Each constant homotopy was accompanied by a diagram detailing the domains of definition of each ‘part’ of the function. If one restricts the function to constant s (i.e. to a copy of $I \subset I^2$), it is constant whenever t lies in a shaded region, and a linear map in t otherwise. If one considers fibres of the map $I^2 \rightarrow I$ they are one-dimensional subspaces that are vertical in white regions and horizontal in shaded regions. Then any notion of homotopy between maps specified in this way can be given by a ‘movie’ showing how the shaded regions change as we vary r (recall the convention of coordinates r, s and t from the end of section 1). The shaded regions are given as (possibly non-convex) polygons, and provided we only move vertices simultaneously (as r increases) if they do not lie on a common edge, this defines polyhedra in I^3 . These polyhedra will play a rôle equivalent to that of the shaded regions in I^2 in defining a map $I^3 \rightarrow I$. Given that at each slice $\{r_0\} \times I^2$ the function to I is fixed at the top and bottom edges

⁸To give the reader an appreciation of the possible complexity, she is invited to consult pages 84 to 89 of [Ste00] where the full equational details of the fundamental bigroupoid of a space are given.

one can apply geometric intuition to see what the resulting homotopy between the (specified) paths in I look like.

- (1) Let $f: \mathfrak{p} \rightarrow X$ and $g: \mathfrak{q} \rightarrow X$ be paths such that $f(1) = g(0) = x$. We need to check that this diagram

$$\begin{array}{ccc} (g \cdot \underline{x}) \cdot f & \xrightarrow{a_{g\underline{x}f}} & g \cdot (\underline{x} \cdot f) \\ & \searrow r_g \cdot \text{id}_f & \swarrow \text{id}_g \cdot l_f \\ & g \cdot f & \end{array}$$

of 2-tracks commutes. Let us set $[U_1] := \text{id}_g \cdot l_f + a_{g\underline{x}f}$ and $[U_2] := r_g \cdot \text{id}_f$. The surfaces U_1 and U_2 are given (after improving the domains to 2-partitions) by composites

$$h_{U_1}^*(\mathfrak{p} \vee_t \mathfrak{q}) \rightarrow \mathfrak{p} \vee_t \mathfrak{q} \xrightarrow{g \cdot f} X, \quad h_{U_2}^*(\mathfrak{p} \vee_t \mathfrak{q}) \rightarrow \mathfrak{p} \vee_t \mathfrak{q} \xrightarrow{g \cdot f} X$$

where the homotopies $h_{U_i}: I^2 \rightarrow I$ are given by

$$h_{U_1}(s, t) = \begin{cases} t & \text{on (1)} \\ 1 - s & \text{on (2)} \\ 2t & \text{on (3)} \\ 4s & \text{on (4)} \\ t & \text{on (5)} \\ 4s - 1 & \text{on (6)} \\ 2t - 1 & \text{on (7)} \\ \frac{1}{2} & \text{on (8)} \end{cases}$$

with the subsets (1)-(8) defined as

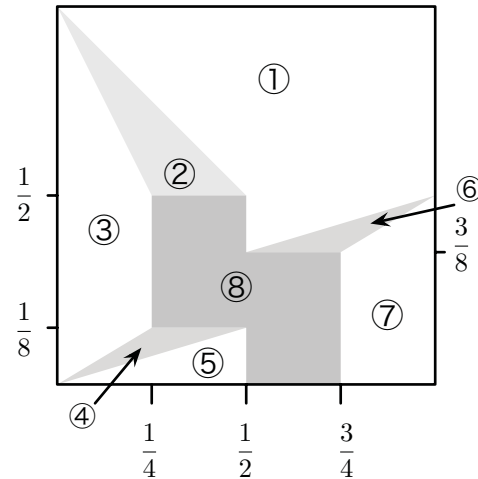

and

$$h_{U_2}(s, t) = \begin{cases} t & \text{on (1)} \\ (s + 1)/2 & \text{on (2)} \\ 2t - 1 & \text{on (3)} \end{cases}$$

with the subsets (1)-(3) defined as

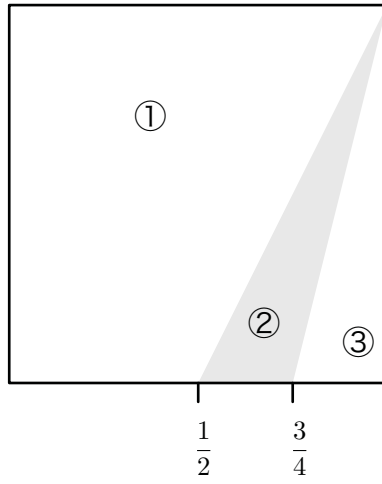

We have the following sequences of moves which define the homotopy $H_U : I^3 \rightarrow I$ between h_{U_1} and h_{U_2} as described in the preceding paragraph.

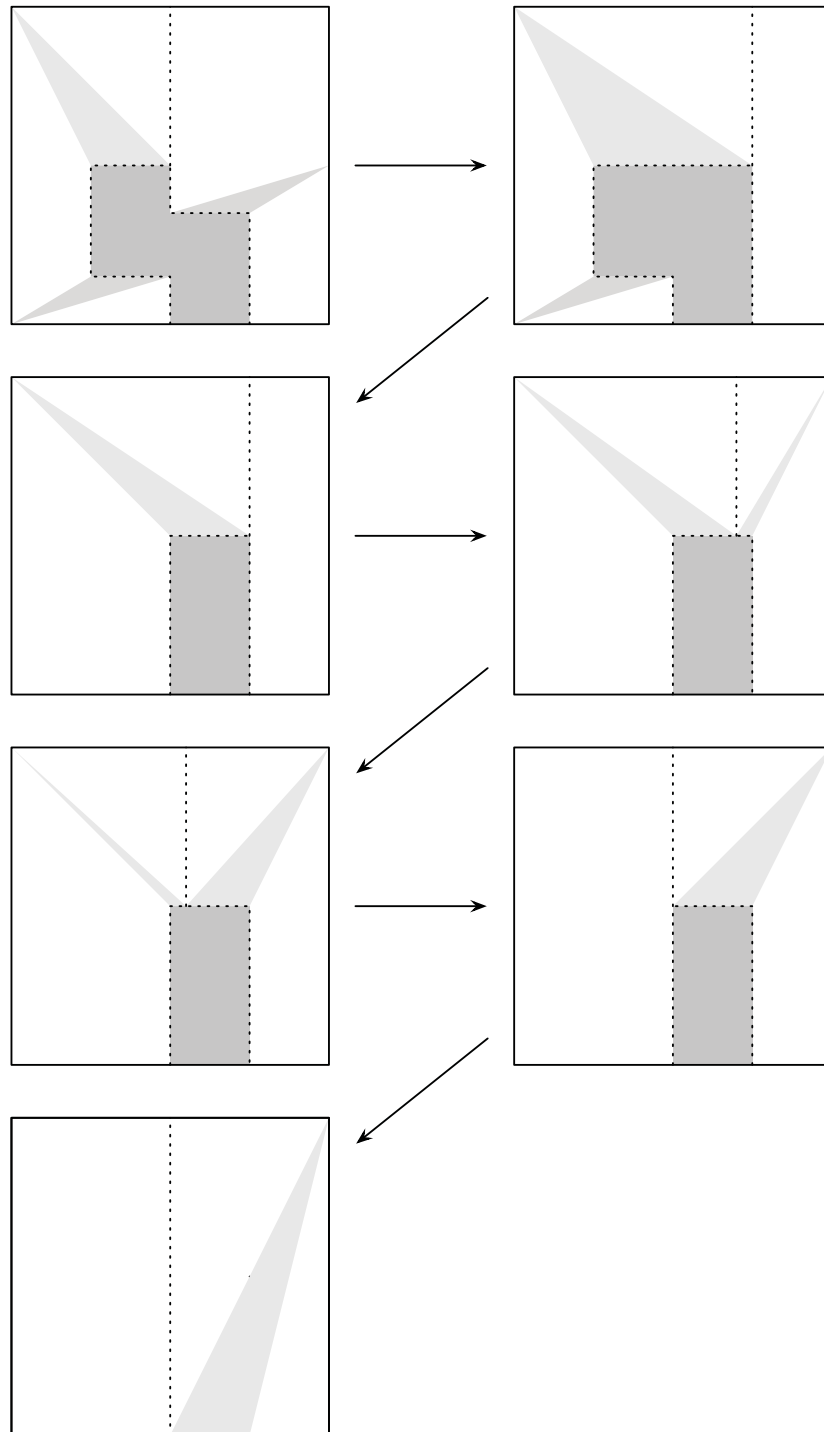

Given H_U , there is a functor $H_U^*(\mathfrak{p} \vee_t \mathfrak{q}) \rightarrow \mathfrak{p} \vee_t \mathfrak{q} \xrightarrow{g.f} X$ which, once the domain is improved to a 3-partition, is a homotopy between the two surfaces U_1 and U_2 . There is thus an equality $[U_1] = [U_2]$ and the coherence equation is satisfied.

(2) Let $f: \mathbf{p} \rightarrow X$ be a path with $f(0) = x_0$ and $f(1) = x_1$. We will show that this diagram

$$\begin{array}{ccccc}
 \underline{x_1} \cdot f & \xrightarrow{i_f \cdot \text{id}_f} & (f \cdot \bar{f}) \cdot f & \xrightarrow{a_{f\bar{f}f}} & f \cdot (\bar{f} \cdot f) \\
 \downarrow l_f & & & & \downarrow \text{id}_f \cdot e_f \\
 f & \xrightarrow{r_f^{-1}} & & & f \cdot \underline{x_0}
 \end{array}$$

of 2-tracks commutes. Actually what we shall show is that *this* diagram commutes:

$$\begin{array}{ccccc}
 \underline{x_1} \cdot f & \xleftarrow{i_f^{-1} \cdot \text{id}_f} & (f \cdot \bar{f}) \cdot f & \xrightarrow{a_{f\bar{f}f}} & f \cdot (\bar{f} \cdot f) \\
 \downarrow l_f & & & & \downarrow \text{id}_f \cdot e_f \\
 f & \xleftarrow{r_f} & & & f \cdot \underline{x_0}
 \end{array}$$

Let us set $[I_1] := r_f + (\text{id}_f \cdot e_f) + a_{f\bar{f}f}$ and $[I_2] := l_f + (i_f^{-1} \cdot \text{id}_f)$. The surfaces I_1 and I_2 are given (after improving the domains to 2-partitions) by composites

$$h_{I_1}^* \mathbf{p} \rightarrow \mathbf{p} \xrightarrow{f} X, \quad h_{I_2}^* \mathbf{p} \rightarrow \mathbf{p} \xrightarrow{f} X$$

where the homotopies $h_{I_i}: I^2 \rightarrow I$ are given by

$$h_{I_1}(s, t) = \begin{cases} t & \text{on (1)} \\ 4s - 3 & \text{on (2)} \\ 4t & \text{on (3)} \\ 3 - 4s & \text{on (4)} \\ 2 - 4t & \text{on (5)} \\ 2t & \text{on (6)} \\ 8s & \text{on (7)} \\ \frac{3-8s}{2} & \text{on (8)} \\ 8s - 3 & \text{on (9)} \\ 2t & \text{on (10)} \\ 3 - 4t & \text{on (11)} \\ 4t & \text{on (12)} \end{cases}$$

with the subsets (1)-(12) defined as

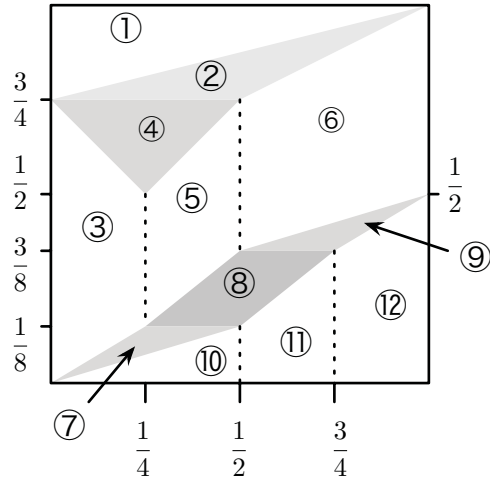

and

$$h_{I_2}(s, t) = \begin{cases} 2t & \text{on (1)} \\ 2 - 2s & \text{on (2)} \\ t & \text{on (3)} \\ 3 - 4t & \text{on (4)} \\ 2s & \text{on (5)} \\ 4t - 3 & \text{on (6)} \end{cases}$$

with the subsets (1)-(6) defined as

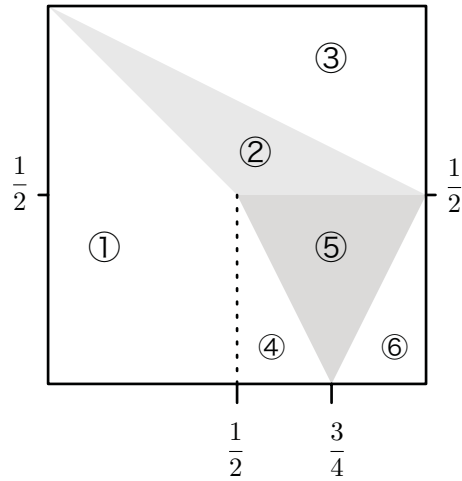

We have the following sequences of moves which define the homotopy $H_I: I^3 \rightarrow I$ between h_{I_1} and h_{I_2} , as described in the paragraph above.

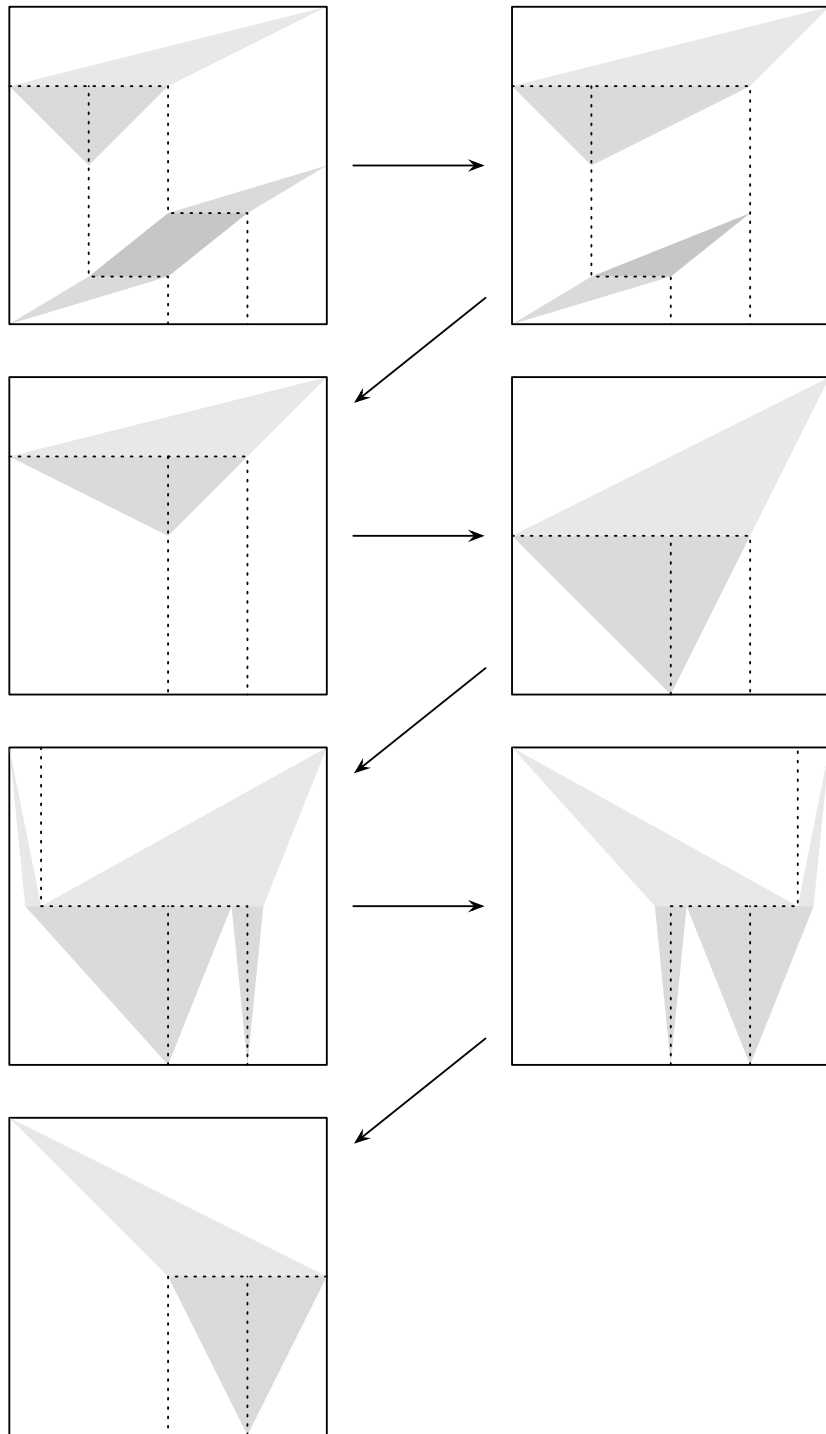

Given H_I , there is a functor $H_I^* \mathfrak{p} \rightarrow \mathfrak{p} \xrightarrow{f} X$ which, once the domain is improved to a 3-partition, is a homotopy between the two surfaces I_1 and I_2 . There is thus an equality $[I_1] = [I_2]$ and the coherence equation is satisfied.

- (3) Let $f_i: \mathfrak{p}_i \rightarrow X$, $i = 1, \dots, 4$, be paths such that $((f_4 \cdot f_3) \cdot f_2) \cdot f_1$ is defined. We will show that the diagram

$$\begin{array}{ccccc}
 & & ((f_4 \cdot f_3) \cdot f_2) \cdot f_1 & \xrightarrow{a_{f_4 f_3 f_2} \cdot \text{id}_{f_1}} & (f_4 \cdot (f_3 \cdot f_2)) \cdot f_1 \\
 & \swarrow^{a_{(f_4 \cdot f_3) f_2 f_1}} & & & \searrow^{a_{f_4 (f_3 \cdot f_2) f_1}} \\
 (f_4 \cdot f_3) \cdot (f_2 \cdot f_1) & & & & f_4 \cdot ((f_3 \cdot f_2) \cdot f_1) \\
 & \searrow^{a_{f_4 f_3 (f_2 \cdot f_1)}} & & & \swarrow^{\text{id}_{f_4} \cdot a_{f_3 f_2 f_1}} \\
 & & f_4 \cdot (f_3 \cdot (f_2 \cdot f_1)) & &
 \end{array}$$

commutes. Define

$$[A_1] := \text{id}_{f_4} \cdot a_{f_3 f_2 f_1} + a_{f_4 (f_3 \cdot f_2) f_1} + a_{f_4 f_3 f_2} \cdot \text{id}_{f_1}$$

and

$$[A_2] := a_{f_4 f_3 (f_2 \cdot f_1)} + a_{(f_4 \cdot f_3) f_2 f_1}.$$

The surfaces A_1 and A_2 are given (after improving the domains to 2-partitions) by composites

$$\begin{aligned}
 h_{A_1}^* \left(\bigvee_t (\mathfrak{p}_4, \mathfrak{p}_3, \mathfrak{p}_2, \mathfrak{p}_1) \right) &\rightarrow \bigvee_t (\mathfrak{p}_4, \mathfrak{p}_3, \mathfrak{p}_2, \mathfrak{p}_1) \xrightarrow{(f_4, f_3, f_2, f_1)} X, \\
 h_{A_2}^* \left(\bigvee_t (\mathfrak{p}_4, \mathfrak{p}_3, \mathfrak{p}_2, \mathfrak{p}_1) \right) &\rightarrow \bigvee_t (\mathfrak{p}_4, \mathfrak{p}_3, \mathfrak{p}_2, \mathfrak{p}_1) \xrightarrow{(f_4, f_3, f_2, f_1)} X
 \end{aligned}$$

where the homotopies $h_{A_i} : I^2 \rightarrow I$ are given by

$$h_{I_1}(s, t) = \begin{cases} 2t & \text{on (1)} \\ t + \frac{1}{4} & \text{on (2)} \\ 3s - 2 & \text{on (3)} \\ \frac{12s-25}{4} & \text{on (4)} \\ \frac{12s-9}{4} & \text{on (5)} \\ t & \text{on (6)} \\ 2t - \frac{1}{4} & \text{on (7)} \\ \frac{2t+1}{4} & \text{on (8)} \\ 3s - 1 & \text{on (9)} \\ \frac{t}{2} & \text{on (10)} \\ 2t - \frac{3}{4} & \text{on (11)} \\ t & \text{on (12)} \\ \frac{12s+1}{4} & \text{on (13)} \\ \frac{12s-3}{8} & \text{on (14)} \\ 3s & \text{on (15)} \\ t - \frac{1}{4} & \text{on (16)} \\ 2t - 1 & \text{on (17)} \end{cases}$$

with the subsets (1)-(17) defined as

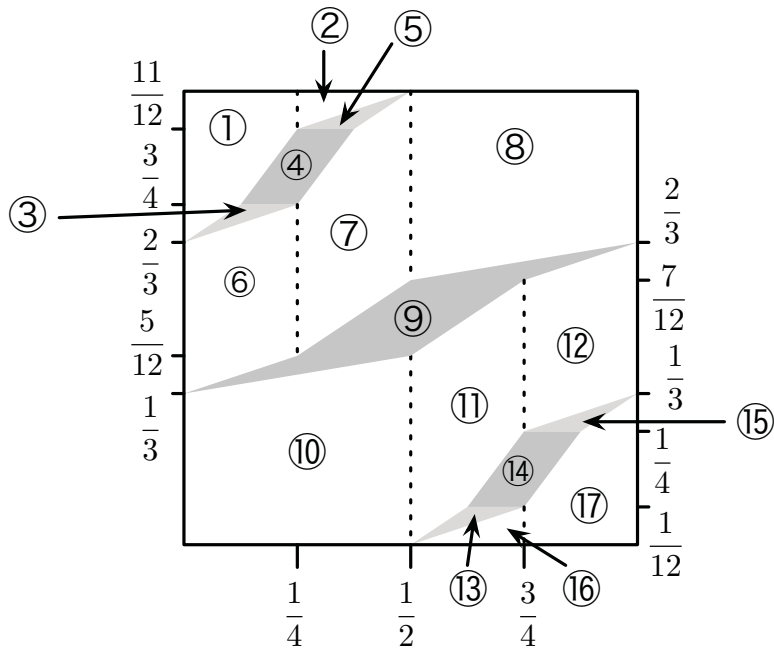

and

$$h_{I_1}(s, t) = \begin{cases} 2t & \text{on (1)} \\ t + \frac{1}{4} & \text{on (2)} \\ \frac{2t+1}{4} & \text{on (3)} \\ 4s - 2 & \text{on (4)} \\ s - \frac{1}{8} & \text{on (5)} \\ 2s - 1 & \text{on (6)} \\ t & \text{on (7)} \\ 2s & \text{on (8)} \\ s + \frac{1}{8} & \text{on (9)} \\ 4s - 1 & \text{on (10)} \\ \frac{t}{2} & \text{on (11)} \\ t - \frac{1}{4} & \text{on (12)} \\ 2t - 1 & \text{on (13)} \end{cases}$$

with the subsets (1)-(13) defined as

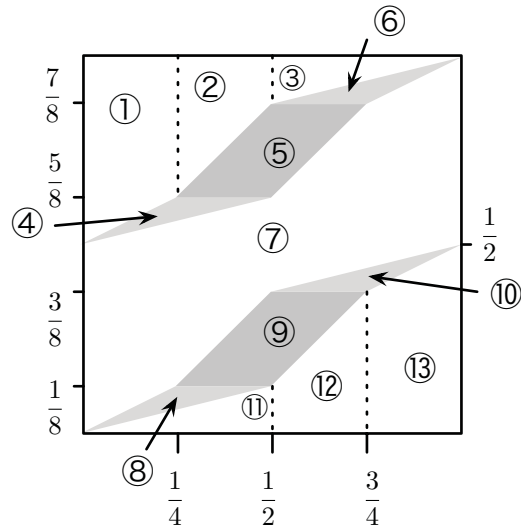

We have the following sequences of moves which define the homotopy $H_A: I^3 \rightarrow I$ between h_{A_1} and h_{A_2} , as described in the paragraph above.

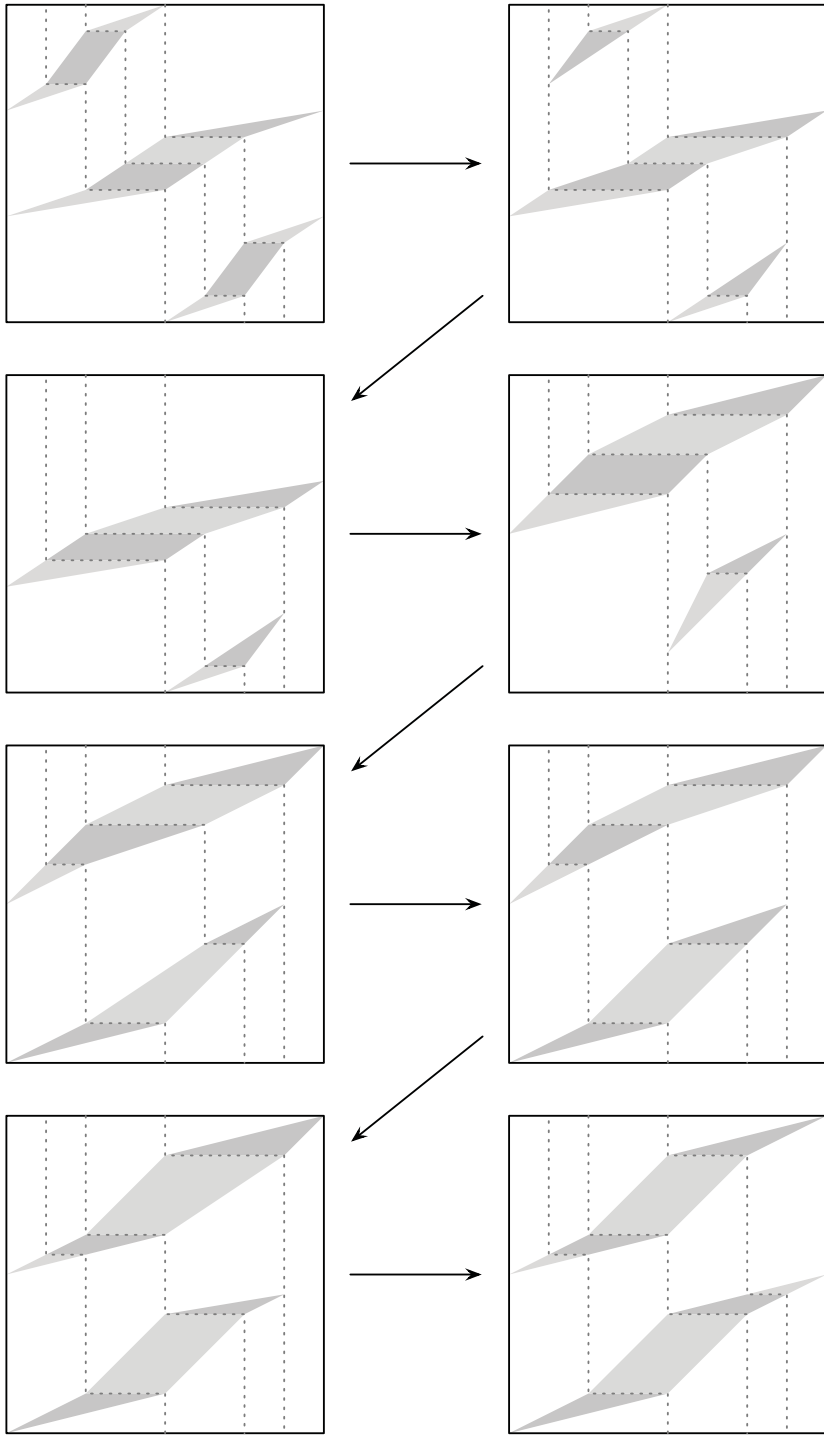

Given H_A , there is a functor

$$H_A^* \left(\bigvee_t (\mathfrak{p}_4, \mathfrak{p}_3, \mathfrak{p}_2, \mathfrak{p}_1) \right) \rightarrow \bigvee_t (\mathfrak{p}_4, \mathfrak{p}_3, \mathfrak{p}_2, \mathfrak{p}_1) \xrightarrow{(f_4, f_3, f_2, f_1)} X$$

which, once the domain is improved to a 3-partition, is a homotopy between the two surfaces A_1 and A_2 . There is thus an equality $[A_1] = [A_2]$ and the coherence equation is satisfied.

Thus we have shown that the necessary coherence conditions are satisfied, and $\Pi_2(X)$ is a bigroupoid. \square

DEFINITION 2.101. Let $f: X \rightarrow Y$ be a functor. We define a strict 2-functor $f_*: \Pi_2(X) \rightarrow \Pi_2(Y)$ as follows:

- The object component f_* is just $f_0: X_0^\delta \rightarrow Y_0^\delta$, the object component of f considered as a function between the underlying sets of X_0 and Y_0 .
- The 1-arrow component of f_* is just the composition with the functor f .
- The 2-arrow component of f_* is again composition with f .

Functoriality follows from the uniqueness guaranteed by lemma 2.78. The structure morphisms are clearly carried to structure morphisms.

PROPOSITION 2.102. *There is a functor*

$$\Pi_2: TG_0 \rightarrow \mathbf{Bigpd}$$

from the category of topological groupoids to the category of bigroupoids and strict 2-functors.

The proof follows immediately from the definition of f_* . We shall see some properties of this functor, including what it looks like on various subcategories, in the next section.

EXAMPLE 2.103. If $*$ is the trivial groupoid, $\Pi_2(*)$ has one object, has the set of partitions as its 1-arrows and has a unique 2-arrow between any ordered pair of 1-arrows. As such it is the codiscrete 2-group with objects the partitions and the product of objects is amalgamation of partitions. It goes without saying that this bigroupoid is equivalent to the trivial bigroupoid with a single 2-arrow on a single 1-arrow on a single object.

Given our fundamental bigroupoid, we can make some supplementary definitions.

DEFINITION 2.104. For topological groupoids X, Y with basepoints $x \in X_0$ and $y \in Y_0$, a *strictly pointed functor* is a functor $f: X \rightarrow Y$ such that $f(x) = y$.

DEFINITION 2.105. For a topological groupoid X with a basepoint $x \in X_0$,

- The *set of connected components* of X , $\pi_0(X)$, is the set of connected components of $\Pi_2(X)$.⁹

⁹This is to be contrasted with the space of orbits of X . When X is t-d, we shall see that these two concepts coincide.

- The *fundamental groupoid* of X , $\Pi_1(X)$, is the Poincaré groupoid ([Bén67]) of $\Pi_2(X)$.
- The *fundamental group* of X , $\pi_1(X, x)$, is the automorphism group of x in $\Pi_1(X)$.
- The *fundamental 2-group* of X , $\Pi_2(X, x)$, is the autoequivalence 2-group of $x \in \Pi_2(X)$.
- The *second homotopy group* of X , $\pi_2(X, x)$, is the automorphism group of $x \in \Pi_2(X, x)$.

The last three of these are functorial with respect to strictly pointed functors, and π_0 , Π_1 are functorial with respect to arbitrary functors. The usual meanings of *path-connected*, *simply/1-connected* and *2-connected* apply to topological groupoids using these definitions.

We remind the reader that an equivalence of fundamental bigroupoids induces isomorphisms between the corresponding homotopy groups, and equivalences between the fundamental groupoids.

The following result is standard fare for low-dimensional groupoid theory.

PROPOSITION 2.106. *Let X be a topological groupoid. Then*

- *If X is path-connected, $\Pi_2(X)$ is equivalent to $\mathbf{B}\Pi_2(X, x)$ for any basepoint $x \in X_0$.*
- *If X is 1-connected, $\Pi_2(X)$ is equivalent to $\mathbf{B}\mathbf{B}\pi_2(X, x)$ for any basepoint $x \in X_0$.*
- *If X is 2-connected, $\Pi_2(X)$ is equivalent to $*$, the trivial bigroupoid.*

The fundamental group of X in the case that X is a so-called *foliation groupoid* has been long in existence, originating in the 1970's with Haefliger [Hae71, Hae90]. More recently, several authors have extended this to the fundamental groupoid when X is a Lie groupoid [MM05, Col06]. There is some slight variation in the definitions, but all of the resulting groupoids are equivalent. It is interesting to note that Haefliger constructed the fundamental group by considering the geometric realisation of the topological groupoid and using its stratification by dimension of the nerve.

Strictly pointed functors are not really the natural choice of arrows between pointed groupoids. When dealing with t-d groupoids, every weakly pointed functor is isomorphic to a strictly pointed one, but that is not the case with topological groupoids. To display the functoriality of $\Pi_2(X, x)$ associated with weakly pointed functors, it is necessary to pass through the 3-category of bigroupoids, strict 2-functors, pseudonatural transformation and modifications. However, the aim of this thesis is not to explore such higher-categorical realms, but to define enough homotopical information to study 2-covering spaces.

7. Calculations and comparisons

In this section we prove that the fundamental bigroupoid constructed in the previous section gives (up to equivalence) the sort of results expected on various subcategories of TG . It gives the fundamental bigroupoid functor Π_2^T described in

[Ste00, HKK01] when restricted to $\mathbf{Top} \subset TG$. If D is a t-d groupoid, i.e. a 1-type, the fundamental bigroupoid is equivalent to a groupoid – D itself. In this sense, the fundamental bigroupoid described in this chapter reflects the expected homotopical information contained in both the spatial and the algebraic aspects of topological groupoids.

First, an almost obvious result analogous to the fact the fundamental group functor preserves products. The projections $X \times Y \rightarrow X$, $X \times Y \rightarrow Y$ induce a functor $\Pi_2(X \times Y) \rightarrow \Pi_2(X) \times \Pi_2(Y)$ with codomain the cartesian product of bicategories.¹⁰

PROPOSITION 2.107. *For topological groupoids X, Y the strict 2-functor*

$$(15) \quad \Pi_2(X \times Y) \rightarrow \Pi_2(X) \times \Pi_2(Y)$$

is an equivalence, and has a canonical pseudoinverse $\Pi_2(X) \times \Pi_2(Y) \rightarrow \Pi_2(X \times Y)$, being the identity on objects and sending paths

$$\gamma_X: \mathfrak{p} \rightarrow X, \quad \gamma_Y: \mathfrak{q} \rightarrow Y$$

to the path

$$(\gamma_X[\mathfrak{p}\mathfrak{q}], \gamma_Y[\mathfrak{p}\mathfrak{q}]) : \mathfrak{p}\mathfrak{q} \rightarrow X \times Y.$$

Proof. The 2-functor (15) is clearly bijective on objects. We first show it is locally essentially surjective. Since there is a surface between a path $\mathfrak{p} \rightarrow X$ and the path $\mathfrak{p}\mathfrak{q} \rightarrow \mathfrak{p} \rightarrow X$ for any partition \mathfrak{q} , and similarly for Y , there is a 2-arrow from any 1-arrow in $\Pi_2(X) \times \Pi_2(Y)$ to one in the image of (15). Similarly, for 2-tracks, given surfaces between paths in X and Y such that the paths have common domains, passing to a common refinement will give a unique 2-track in $X \times Y$. Hence we have an equivalence.

The assignment $(\gamma_X, \gamma_Y) \mapsto (\gamma_X[\mathfrak{p}\mathfrak{q}], \gamma_Y[\mathfrak{p}\mathfrak{q}])$ as above is strictly functorial in that it preserves composition/concatenation, identities and inverses/reverses, and sends structure morphisms (associator etc) to structure morphisms. The claim that identities (id_γ for a path γ and \underline{x}) are preserved strictly is trivially verified. For the rest, the following details should suffice:

- Given n -partitions $\mathcal{R}_i, \mathcal{Q}_i$, $i = 1, 2$ a simple sketch will convince the reader that

$$(\mathcal{R}_1 \mathcal{Q}_1) \vee_y (\mathcal{R}_2 \mathcal{Q}_2) = (\mathcal{R}_1 \vee_y \mathcal{R}_2)(\mathcal{Q}_1 \vee_y \mathcal{Q}_2)$$

for $y = s, t$ and so an application of lemma 2.78 gives us the result that composition and concatenation is preserved, the latter strictly. This also shows us that the operation on 2-tracks is well-defined, as it sends equivalent surfaces to equivalent surfaces (this uses $n = 3$ in the above equation).

- Given n -partitions \mathcal{R}, \mathcal{Q} , let $i_{x_k} : I^n \rightarrow I^n$ be the map $(x_1, \dots, x_k, \dots, x_n) \mapsto (x_1, \dots, 1 - x_k, \dots, x_n)$. Then again it is easy to see that $i_{x_k}^*(\mathcal{R}\mathcal{Q}) = i_{x_k}^* \mathcal{R} i_{x_k}^* \mathcal{Q}$, and so inverses (using $n = 2$ and $x_k = s$) and reverses (using $n = 1, 2$ and $x_k = t$) are preserved. Reverses are preserved strictly.

¹⁰As opposed to, say, the Crans-Gray tensor product.

- The structure maps of $\Pi_2(X) \times \Pi_2(Y)$ are given by $\gamma \mapsto (s_\gamma^X, s_\gamma^Y)$ for any given structure map s (X or Y as the case may be). As for the previous point, we have $h_\gamma^*(\mathcal{R}\mathcal{Q}) = h_\gamma^*\mathcal{R}h_\gamma^*\mathcal{Q}$ for n -partitions \mathcal{R}, \mathcal{Q} and standard homotopy h_γ . This, together with lemma 2.78 ensures that structure maps are preserved. \square

An even easier property is that Π_2 preserves coproducts strictly.

PROPOSITION 2.108. *Given groupoids X and Y , there is an isomorphism $\Pi_2(X \amalg Y) \simeq \Pi_2(X) \amalg \Pi_2(Y)$ where the coproduct of bigroupoids is the strict coproduct.*

Proof. Immediate from the definition. \square

Given the definition of $\Pi_2(X)$, one might imagine that due to the interplay between the algebra and topology it is difficult to tell when X is n -connected ($n = 0, 1, 2$ of course). This is not the case – there are some simple sufficient criteria based on the connectivity of X_0 and X_1 .

If X is a topological groupoid with X_0 path-connected, then obviously the bigroupoid $\Pi_2(X)$ is connected. *a fortiori* it is equivalent to $\mathbf{B}\Pi_2(X, x)$ for any base-point $x \in X_0$. More generally,

LEMMA 2.109. *Let X be a groupoid such that for each pair of distinct path components $C_1, C_2 \subset X_0$ there are objects $c_i \in C_i$ that are connected by an arrow of X . Then X is path-connected and the converse is also true.*

The proof of this is a simple exercise so it is omitted.

There is a similar result dealing with the 1-type of X using the homotopy information of both the spaces X_1, X_0 . This time the result is only in one direction, but is useful in establishing the fact two groupoids are not weakly equivalent.

LEMMA 2.110. *If X be a topological groupoid such that X_0 is 1-connected and X_1 is path connected, then X is 1-connected.*

Proof. First, since X_0 is path-connected, there is an equivalence $\mathbf{B}\Pi_2(X, x) \xrightarrow{\sim} \Pi_2(X)$ for some object $x \in X$. Let $\gamma: \mathbf{p} \rightarrow X$ be a loop at x , where the partition is given by $\{t_1, \dots, t_n\}$. We will show that for every loop $\gamma_n: \mathbf{p} \rightarrow X$ at x there is a 2-track $[f]: \gamma_n \Rightarrow \gamma_{n-1}$ to a loop $\gamma_{n-1}: \mathbf{q} \rightarrow X$ where the partition \mathbf{q} has one less connected component than \mathbf{p} . Continuing in this way, this implies that every loop is homotopic to one of the form $\text{disc}(I) \rightarrow X$. Since X_0 is simply connected, this loop is homotopic to the constant loop x .

Let $\gamma: \mathbf{p} \rightarrow X$ be a loop, where \mathbf{p} is as in the previous paragraph. Consider the segments $\gamma^1 = \gamma|_{[0, t_1^-]}$ and $\gamma^2 = \gamma|_{[t_1^+, t_2^-]}$ in X_0 and let g_1 be the arrow which is the image of (t_1^-, t_1^+) . Since X_1 is path-connected, choose a path $\eta: I \rightarrow X_1$ from $g_1 \rightarrow \text{id}_x$. This defines paths $\eta^-, \eta^+: I \rightarrow X_0$ from $\gamma^1(0)$ to $\gamma^1(t_1^-)$ and $\gamma^2(t_1^+)$ respectively. Since X_0 is simply connected, choose a map $\varphi: I \times [0, t_1] \rightarrow X_0$ such

that

$$\varphi(s, t) = \begin{cases} \gamma^1(t) & \text{when } s = 0, \\ \gamma(0) & \text{when } s = 1 \text{ or when } t = 0, \\ \eta^-(s) & \text{when } t = t_1. \end{cases}$$

Define a new loop $\gamma': \mathfrak{p} \rightarrow X$ by

$$\gamma'(t) = \begin{cases} \gamma(0) & t \in [0, t_1^-], \\ \gamma^2 \# \overline{\eta^+}(t) & t \in [t_1^+, t_2^-], \\ \gamma(t) & t \geq t_2^+ \end{cases}$$

on objects, where $\gamma^2 \# \overline{\eta^+}: [t_1^+, t_2^-] \rightarrow X_0$ is the concatenation of γ^2 and $\overline{\eta^+}$, scaled so that the domain is as shown. We then define γ' on arrows by

$$\gamma'(t) = \begin{cases} \text{id}_{\gamma(0)} & t = (t_1^-, t_1^+), \\ \gamma(t) & t = [t_i^+, t_i^-], \quad i = 2, \dots, n. \end{cases}$$

Consider the 2-partition $I \times \mathfrak{p}$, and note that we have defined functors on the subgroupoids $\{0\} \times \mathfrak{p}$ (namely, γ) and $\{1\} \times \mathfrak{p}$ (namely, γ'). The map φ furnishes us with the object component of a functor $f: I \times \mathfrak{p} \rightarrow X$ on the region $I \times [0, t_1^-]$, and η gives the arrow component on coordinates $(s, s; t_1^+, t_1^+)$:

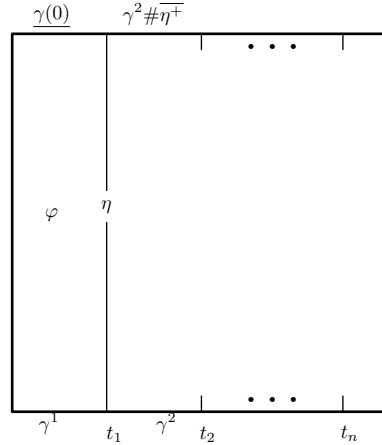

Next, there is a map $\psi: I \times [t_1, t_2] \rightarrow X_0$ such that

$$\psi(s, t) = \begin{cases} \gamma^2(t) & \text{when } s = 0, \\ \gamma^2 \# \overline{\eta^+}(t) & \text{when } s = 1, \\ \eta(s) & \text{when } t = t_1, \\ \gamma^2(t_2) & \text{when } t = t_2. \end{cases}$$

This gives the functor f on the region $I \times [t_1^+, t_2^-]$:

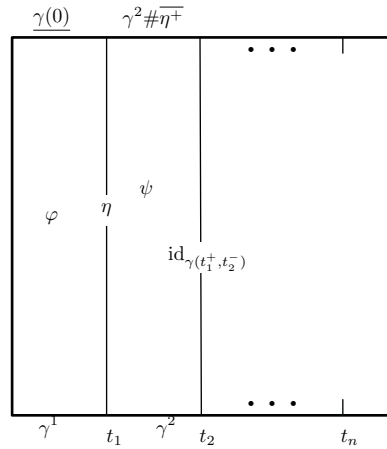

where $\underline{\gamma(t_2^-, t_2^+)}$ is the constant path in X_1 at the indicated arrow. Then the constant homotopies on the remain segments will give us the surface f in its entirety. Notice that γ' can be considered as a sort of ‘weighted’ concatenation involving the constant path $\underline{\gamma(0)}$. The standard right unitor $r_{(-)}$ can be modified to give a surface to a loop γ'' with domain a partition groupoid \mathfrak{p}' with one less region than \mathfrak{p} .

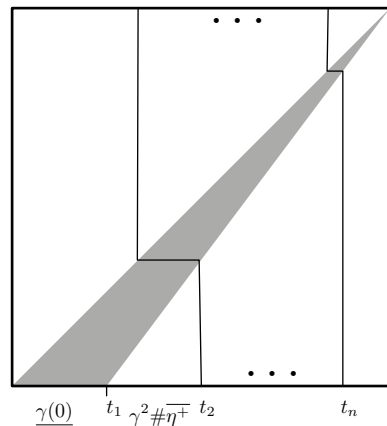

the composition of this surface with f gives a surface from γ to a loop with a domain with one less region, as promised. Iterating this procedure eventually gives a surface from γ to a loop $I \rightarrow X$, which, by the simply-connectivity of X_0 , is null homotopic. \square

EXAMPLE 2.111. Let G be a path-connected topological group. Then the *groupoid* $\mathbf{BG} = (G \rightrightarrows *)$ clearly satisfies the conditions of the lemma, and so is simply connected (see definition 2.105). This is the analogue of the result that for a path-connected topological group G , the classifying space BG is simply connected.

PROPOSITION 2.112. *If X be a groupoid such that X_0 is 2-connected and X_1 is 1-connected, then X is 2-connected.*

Proof. Firstly, X satisfies the conditions of proposition 2.110, so is 1-connected. This means that $\Pi_2(X)$ is transitive, and any two paths between two objects have a 2-track between them. We will show that this 2-track is unique.

Let $\gamma_\epsilon: \mathfrak{p}_\epsilon \rightarrow X$, $\epsilon = 0, 1$ be paths and $f_i: \mathfrak{h}_i$, $i = 1, 2$ be surfaces between them. We can assume that $\mathfrak{h}_1 = \mathfrak{h}_2 =: \mathfrak{h}$, because otherwise we could pass to a common refinement, and this would give us the same pair of 2-tracks. By remark 2.69 we can assume that \mathfrak{h} is almost regular and the f_i have sitting instants. We want to find a homotopy $F: \mathfrak{H} \rightarrow X$ between f_1 and f_2 . Because of the sitting instants, which we take to be for s taking values in $[0, a]$ and $[b, 1]$, we can define F on $[0, a] \times \mathfrak{H}|_{s=0}$ and $[b, 1] \times \mathfrak{H}|_{s=1}$ to be constant in the r -direction, since f_1 and f_2 agree on those subgroupoids. We can then restrict further to the case that \mathfrak{h} is regular, that is, of the form $\mathfrak{q} \times \mathfrak{p}$.

We shall let $\mathfrak{H} = I \times \mathfrak{q} \times \mathfrak{p}$ and show that it is possible to construct the required homotopy by induction on the number of regions in \mathfrak{q} . The data of the two surfaces f_i with the matching boundary paths gives a functor $F: \partial\mathfrak{H} \rightarrow X$ where $\partial\mathfrak{H}$ is the subgroupoid of \mathfrak{H} that sits over the boundary ∂I^3 . Assume first that $\mathfrak{q} = I$, so that $\mathfrak{H} = I^2 \times \mathfrak{p}$, and assume \mathfrak{p} is given by $\{t_1, \dots, t_n\}$. The subspace of the first region $I^2 \times [0, t_1^-]$ on which F is defined is the union of five faces of a cube (up to some scaling, obviously!). Consider the loop in X_0 given by restricting F to the boundary of this subspace, which is the subgroupoid $\partial I^2 \times \{t_1^-\}$. As X_0 is 2-connected, we can fill this loop, giving a map $I^2 \times \{t_1^-\} \rightarrow X$, shown here coloured grey:

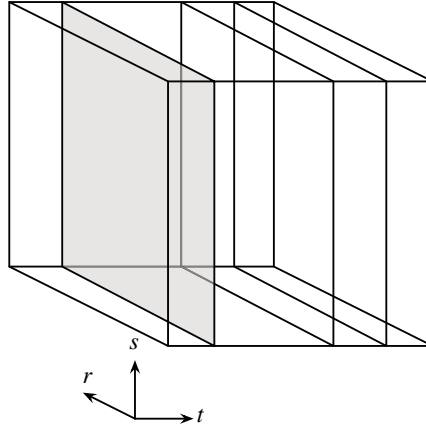

Since F is already defined on the five other faces of $\partial(I^2 \times [0, t_1^-])$, we have a map from the boundary of a region into X_0 . We again use the 2-connectedness of X_0 to extend this to a map $I^2 \times [0, t_1^-] \rightarrow X_0$, shown in grey:

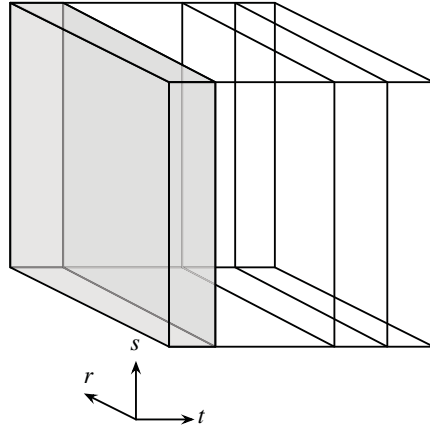

Now notice that because F is defined on the subgroupoid ∂I^2 , there is loop $\partial I^2 \rightarrow X_1$ given by considering the arrows in $\partial \mathfrak{H}$ for which the t -coordinate is (t_1^-, t_1^+) (the loop in X_0 we considered earlier is the composite of this loop with the source map of X). Since X_1 is 1-connected, we can find a map $\sigma_1: I^2 \rightarrow X_1$ filling this loop, considering $I^2 \subset \mathfrak{H}_1$. Then $t \circ \sigma_1$ gives us a face of the next region, giving us again a map defined on the union of five faces of a region. Iterating this, and using the fact X_0 is 2-connected, we have extended F to a functor $\mathfrak{H} \rightarrow X$. By definition it is a homotopy and so the two surfaces f_i represent the same 2-track.

Now assume that \mathfrak{q} is given by $\{s_1, \dots, s_m\}$, and let $\mathfrak{H} = I \times \mathfrak{q} \times \mathfrak{p}$. A handy mental image is of rows of regions stacked in layers. We are again given, by the assumptions above, a functor $F(1): \partial \mathfrak{H} \rightarrow X$. Consider the restriction of F to the intersection of subgroupoid $I \times [0, s_1^-] \times \mathfrak{p}$ with $\partial \mathfrak{H}$. This intersection looks something like an open box:

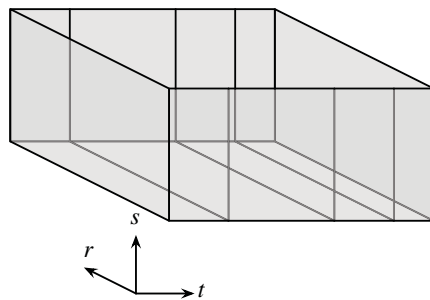

Because X_1 is 1-connected, we can find a path between the arrows which are the images of the arrows at the positions marked with $*$ in the previous picture (these have t -coordinate given by (t_1^-, t_1^+)). We can do the same for the pairs of arrows sitting at $t = (t_k^-, t_k^+)$ for $k = 2, \dots, n$, giving us an extended functor $F(2)$ with codomain X whose domain of definition looks like

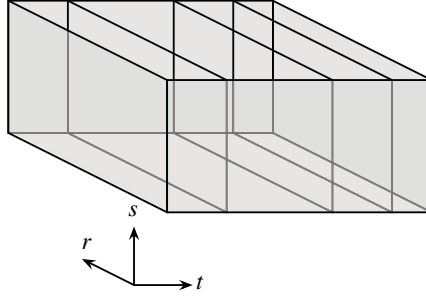

From the first region on the left, we get a loop in X_1 by restricting the arrow part of F' to $\partial(I \times [0, s_1^-] \times \{(t_1^-, t_1^+)\})$ (vertical loop on the right hand side of the region). By the simple connectedness of X_1 this extends to a map $I \times [0, s_1^-] \times \{(t_1^-, t_1^+)\} \rightarrow X_1$, and by applying the source and target of f , maps $I \times [0, s_1^-] \times \{t_1^\pm\} \rightarrow X_1$. The newly extended functor $F(3)$ has domain looking like

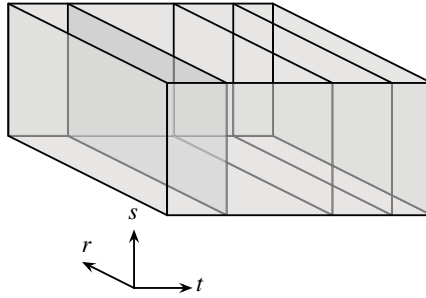

We can do the same for the loop that is the boundary of the top face of the leftmost region: this is a loop in X_1 and so can be filled, and then the source map of X applied so that our functor is extended to $F(4)$, with the whole boundary $\partial(I \times [0, s_1^-] \times [0, t_1^-])$ is contained within the domain. Now notice that $F(4)$ is defined on the analogous subspace of the next region $I \times [0, s_1^-] \times [t_1^+, t_2^-]$ as $F(2)$ was on the first region. We can thus repeat the previous steps to extend our putative homotopy over this region, and so on, until it is defined on the subgroupoid $I \times [0, s_1^-] \times \mathfrak{p} \subset \mathfrak{H}$.

In the process of extending to $F(4)$, we defined a map $I \times [0, t_1^-] \rightarrow X_1$ (considering here the domain as being at s -coordinate (s_1^-, s_1^+)). Then if we apply the target map to this we get a map $I \times \{s_1^+\} \times [0, t_1^-] \rightarrow X_1$, which defines the functor on the bottom face of the leftmost region in the next layer of regions.

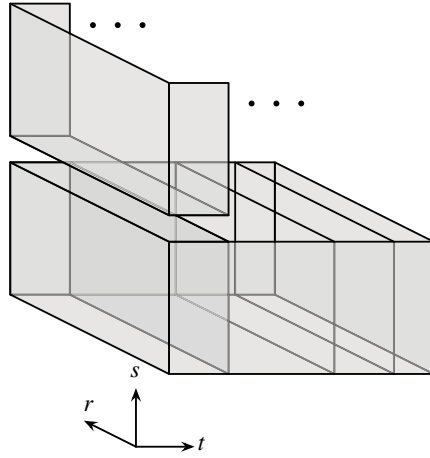

The same can be said of the whole process of extending over each region in the bottom layer, so the bottom faces of all the regions in the next layer have our functor defined over them. The algorithm described in the previous paragraph can be applied again to this layer, and so on until we reach the top layer, where we can apply the reasoning from the $\mathfrak{q} = I$ case. Thus there is a homotopy $F: \mathfrak{H} \rightarrow X$ between f_1 and f_2 , and they represent the same 2-track. Thus any two paths have a unique 2-track between them, and $\Pi_2(X)$ is trivial – X is thus 2-connected. \square

EXAMPLE 2.113. If we take a topological group G which is 1-connected, then the one-object groupoid $\mathbf{B}G$ is 2-connected.

Another situation when a groupoid is 2-connected is if it is codiscrete.

LEMMA 2.114. *For M a space, $\Pi_2(\text{codisc}(M))$ is equivalent to the trivial bi-groupoid.*

Proof. Firstly, notice that every point in M has an arrow to every other point, so by lemma 2.109 $\text{codisc}(M)$ is 0-connected. Also, for a pair of paths $\mathfrak{p}_\epsilon \rightarrow X$ with matching endpoints, there is a unique arrow between them in $\text{Path}_r(\text{codisc}(M))$. Thus by example 2.41 there is a surface between these two paths, and so $\text{codisc}(M)$ is 1-connected. Given two surfaces between a pair of paths, which we can assume have a common domain \mathfrak{h} , there is a natural transformation between them, and so by the same reasoning as for the case of paths, we get a homotopy between these two surfaces. Thus $\text{codisc}(M)$ is 2-connected. \square

One example to keep in mind for later is the (strict) fibre of a weak equivalence $f: X \rightarrow Y$ – if $y \in Y_0$ is in the image of f , the strict fibre $f^{-1}(y)$ is equal to $\text{codisc}(f_0^{-1}(y))$.

Groupoids are algebraic models of 1-types and so should not contain any two-dimensional homotopical information (or higher-dimensional for that matter). This is reflected by the following lemma.

LEMMA 2.115. *If D is a t - d groupoid, $\Pi_2(D)$ is equivalent to a groupoid.*

Proof. Notice first that any functor $\eta: \mathcal{R} \rightarrow D$ for \mathcal{R} an n -partition groupoid factors through a finite codiscrete groupoid. It is most easily described as having objects $\{\mathbf{x}_i\}$ where \mathbf{x}_i is a representative point in the region $R_i \subset \mathcal{R}$. The image of η is then a codiscrete subgroupoid of D . We now want to show that $\Pi_2(D)$ is equivalent to a groupoid – this will follow if the automorphism group of every 1-arrow is trivial. Let $\gamma: \mathbf{p} \rightarrow D$ be a path, and $f_i: \mathfrak{h}_i \rightarrow D$, $i = 1, 2$ represent 2-tracks with source and target both equal to γ . We can without loss of generality assume that $\mathfrak{h}_1 = \mathfrak{h}_2$ as we can always take a common refinement and then the homotopies induced by precomposition represent the same 2-track. Thus we have a 2-partition groupoid \mathfrak{h} and functors $f'_i: \mathfrak{h} \rightarrow \text{codisc}(\{\mathbf{x}_i\})$, $i = 1, 2$. There is, by virtue of the contractibility of the codomain, a transformation between f'_1 and f'_2 which is the identity transformation on the relevant boundaries of \mathfrak{h} . Hence there is a transformation $f_1 \Rightarrow f_2: \mathfrak{h} \rightarrow D$. Thus by example 2.58 the two homotopies represent the same 2-track, and so there is at most one 2-track between any two paths. \square

If X is a space, there is a natural arrow $X^\delta \rightarrow \Pi_2^T(X)$ including X^δ as the set of objects of the fundamental bigroupoid of X . If X is a topological groupoid, however, arrows of the groupoid contribute to the 1-arrows of the fundamental bigroupoid, as well as the objects of the topological groupoid being the objects of the bigroupoid.

PROPOSITION 2.116. *For X a topological groupoid there is a weak 2-functor $i_\Pi: X^\delta \rightarrow \Pi_2(X)$ which is the identity on objects and sends an arrow $f: x \rightarrow w$ to the path $i_\Pi(f): \mathfrak{d} \rightarrow X$ given by*

$$i_\Pi(f)(t) = \begin{cases} x & t \in [0, \frac{1}{2}^-] \subset \mathfrak{d}_0, \\ y & t \in [\frac{1}{2}^+, 1] \subset \mathfrak{d}_0, \\ f & t = (\frac{1}{2}^-, \frac{1}{2}^+) \in \mathfrak{d}_1 \end{cases}$$

as indicated in the picture:

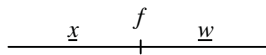

Proof. The 2-track ϕ_{fg} from the appendix, comparing $i_\Pi(f \circ g)$ and $i_\Pi(f) \circ i_\Pi(g)$ is represented by the picture

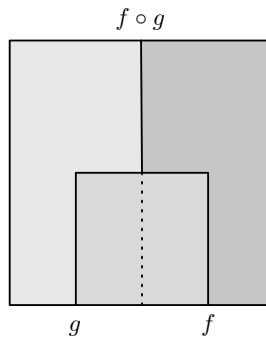

There are no 2-arrows in X^δ so we do not need to check naturality (nor do we need to for any other coherence arrows pertaining to i_Π). What we do need to check is

that the diagram (30) commutes. What this boils down to is showing an equivalence between the following two surfaces:

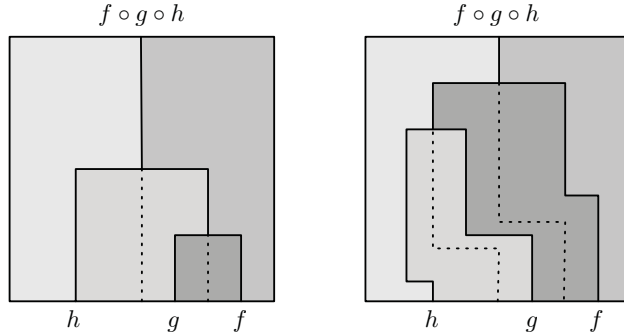

for $h: w \rightarrow x$, $g: x \rightarrow y$, $f: y \rightarrow z$ arrows in X . This can be seen by realising that both of the surfaces (and hence their source and target paths) factor through the t-d groupoid $\text{codisc}(\{w, x, y, z\})$, which is a subgroupoid of X with non-identity arrows h, g, f , their inverses and composites. We can thus apply lemma 2.59 so that the two surfaces above are equivalent, and hence there is at most one 2-track between any two paths.

The 2-track $\phi_x: i_{\Pi}(\text{id}_x) \rightarrow \underline{x}$ from the appendix is represented by the surface

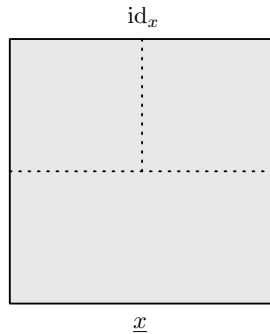

and exactly the same reasoning as the previous paragraph ensure the diagrams (31) commute. That is, that the two surfaces represented by

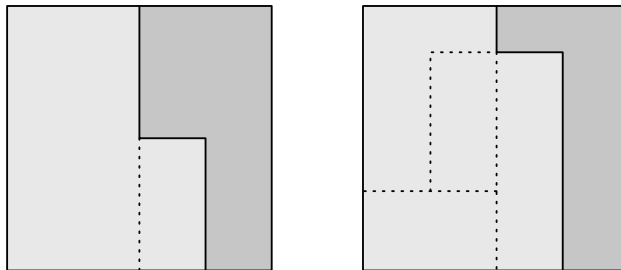

are equivalent (the right square of (31)), and a horizontal flip of these pictures, show that the left square of (31) commutes.

Lastly, inverses are respected on the nose by i_{Π} , and it is easy to see that the two diagrams

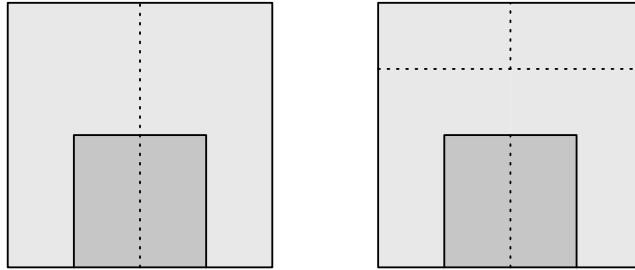

represent the same 2-track, which implies that the left square in (32) commutes, and similarly for the right square. \square

Now one instance where we can use this is where $X = D$ a t-d groupoid, and so we have a weak 2-functor $D \rightarrow \Pi_2(D)$.

PROPOSITION 2.117. *For a t-d groupoid D the 2-functor $i_\Pi: D \rightarrow \Pi_2(D)$ is an equivalence of bigroupoids. Furthermore it is natural, and there is a 2-functor $comp: \Pi_2(D) \rightarrow D$ such that $comp \circ i_\Pi = id_D$.*

Proof. We know already that $\Pi_2(D)$ is equivalent to a groupoid, and that $\Pi_2(D) = D_0$ so we just need to show the sets $D(d_1, d_2)$ are equivalent to the groupoids $\Pi_2(d_1, d_2)$, i.e that $D(d_1, d_2) \rightarrow \Pi_2(D)(d_1, d_2)$ is essentially surjective for all $d_i \in D_0$. Let $\mathbf{p} \rightarrow D$ be a path. There is a surface of the form suggested by the following picture

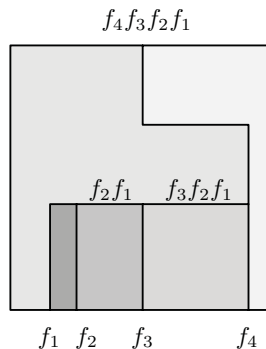

and so every path in D (as a topological groupoid) is isomorphic to a path in the image of i_Π .

Recall that a path in a t-d groupoid is a finite sequence of composable arrows. The 2-functor $comp$ is the identity on objects and sends a path $\mathbf{p} \rightarrow D$ to the composite of the sequence of arrows. The picture in the preceding paragraph shows us that any two paths that are isomorphic in $\Pi_2(D)$ are mapped to identical arrows in D , so $comp$ is well-defined. For an arrow f of D , $comp(i_\Pi(f)) = f$, and so $comp \circ i_\Pi = id_D$. \square

Notice that we can recover the underlying set of a space from its fundamental bigroupoid, but we cannot recover, in an intrinsic fashion, the (underlying t-d groupoid of) the topological groupoid X from its fundamental bigroupoid $\Pi_2(X)$.

In addition, we cannot generically recover the topology of a space from its fundamental bigroupoid, let alone the topology on the topological groupoid. It is possible, in some instances, to define a topology on the fundamental bigroupoid of a space M such that the topology on $\Pi_2(M)_0$ is the same as on M . This will have to wait until chapter 5. Also, there are some circumstances when it is possible to recover, up to equivalence, (the underlying t-d groupoid of) a topological groupoid from its fundamental bigroupoid – in an intrinsic way, that is, without knowledge of the 2-functor i_Π .

We now show that our fundamental bigroupoid is equivalent to that of Hardie-Kamps-Kieboom when the argument is a topological space.

PROPOSITION 2.118. *If X is a space, there is a natural weak 2-functor*

$$H_X: \Pi_2^T(X) \rightarrow \Pi_2(\text{disc}(X))$$

which is an equivalence, and there is a canonical natural retract $R_X: \Pi_2(\text{disc}(X)) \rightarrow \Pi_2^T(X)$.

Proof. The 2-functor H is the identity map at the level of objects and is otherwise given by inclusion. It is strict in some regard – inverses and identities – but it does not respect composition on the nose. The reason for this lack of strictness is that the concatenation of paths in a topological groupoid introduces an additional arrow in the source partition (see the diagram underneath definition 2.77), even if those paths are defined on the partition $I \rightarrow I$. For $\gamma_1, \gamma_2 \in \Pi_2^T(X)_1$, the 2-track $\phi_{\gamma_2\gamma_1}: H(\gamma_2) \circ H(\gamma_1) \Rightarrow H(\gamma_2 \circ \gamma_1)$ is

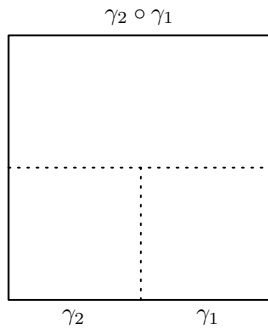

It is clearly natural, and is in fact a very thin 2-track. Thus the relevant coherence diagram is easily seen to commute. As to the left/right unitor coherence diagram (28) in the appendix, and for the inverter coherence diagram (29) in the appendix, they commute by virtue of the naturality of $\phi_{\gamma_2\gamma_1}$. Thus H is a 2-functor, and it is obviously natural.

Since H is bijective on objects, we only need to consider its behaviour on hom-groupoids. Since any path $\gamma: \mathbf{p} \rightarrow \text{disc}(X)$ factors through the partition $I \rightarrow I$, there is the usual 2-track relating the path $\gamma': I \rightarrow \text{disc}(X)$ to its precomposition with a refinement: $\gamma' \Rightarrow \gamma[\mathbf{p}]$. Thus H is locally essentially surjective. Any surface between paths $I \rightarrow \text{disc}(X)$ will factor through I^2 and so will be homotopic to a surface $I^2 \rightarrow \text{disc}(X)$, making H locally full. In the same way, given two surfaces $I^2 \rightarrow X$ between paths $\gamma_1, \gamma_2: I \rightarrow X$ and a homotopy $\mathcal{H}: I^3 \rightarrow \text{disc}(X)$ between their images in $\Pi_2(\text{disc}(X))$, this homotopy factors through I^3 , thus supplying a

homotopy between the original two surfaces. And so H is locally faithful and hence an equivalence.

The 2-functor R_X is the identity of objects, sends a path $\gamma: \mathfrak{p} \rightarrow \text{disc}(X)$, which factors through I uniquely, to the path $I \rightarrow X$ thus determined, and the same for representatives of 2-tracks. As H_X is given by inclusion, R_X is surjective on 1- and 2-arrows. Also, R_X is strict, preserving concatenations, identities and structure morphisms, and the fact that $R_X \circ H_X = \text{id}_{\Pi_2^T(X)}$ is clear. Naturality is also immediate. \square

Since the point of view of this thesis is that a localisation of TG at the weak equivalences¹¹ is a ‘more correct’ bicategory of topological groupoids, it is to be expected that Π_2 sends weak equivalences to equivalences of bigroupoids.

LEMMA 2.119. *Given the weak equivalence $Y[U] \rightarrow Y$, any functor $h: \mathcal{R} \rightarrow Y$ from an n -partition groupoid \mathcal{R} has a refinement which lifts to $Y[U]$*

Proof. Clearly there is a lift at the level of objects: apply the Lebesgue covering lemma to the pullback of the cover U to $\underline{\mathcal{R}}$ to get a refinement of $\underline{\mathcal{R}}$ that lifts to U :

$$\begin{array}{ccc} \underline{\mathcal{R}}' & \longrightarrow & U \\ \downarrow & & \downarrow \\ \underline{\mathcal{R}} & \longrightarrow & Y_0 \end{array}$$

This gives a functor $\mathcal{R}' \rightarrow Y$ by precomposition. Then define $\mathcal{R}'_1 \rightarrow Y[U]_1 = U^2 \times_{Y_0^2} Y_1$ as the canonical arrow appearing in the commuting diagram

$$\begin{array}{ccccc} \mathcal{R}'_1 & \xrightarrow{\hspace{10em}} & Y_1 & & \\ \downarrow & & \downarrow & & \\ \mathcal{R}'_0 \times \mathcal{R}'_0 & \xrightarrow{\hspace{2em}} & U \times U & \xrightarrow{\hspace{2em}} & Y_0 \times Y_0 \end{array}$$

It is easily checked this defines a functor $\mathcal{R}' \rightarrow Y[U]$ lifting h . \square

A simple but important fact to realise is that is if there is a lift h' of h restricted to the boundary of \mathcal{R} , then the lift as in the lemma can be chosen to agree on the boundary with h' , up to a possible refinement. Thus we get the following result:

PROPOSITION 2.120. *The weak equivalence $q: Y[U] \rightarrow Y$ induces an equivalence of bigroupoids $q_*: \Pi_2(Y[U]) \rightarrow \Pi_2(Y)$.*

¹¹recall that we are only considering \mathcal{O} -equivalences at present

Proof. By inspection, q_* is surjective. By lemma 2.119, any path has a refinement which lifts to $Y[U]$, and the path from the refined domain is isomorphic to the original path, making q_* locally essentially surjective.

Let \mathfrak{p}_0 be given by $\{t_1, \dots, t_n\}$ and \mathfrak{p}_1 be given by $\{t'_1, \dots, t'_m\}$. If $\gamma_\epsilon: \mathfrak{p}_\epsilon \rightarrow Y[U]$, $\epsilon = 0, 1$, are two paths with the same endpoints, let $[f]: q \circ \gamma_0 \Rightarrow \gamma_1$ be a 2-track. Choose a representative surface $f: \mathfrak{h} \rightarrow Y$ that is collared, as given by lemma 2.70. We need to use a collared surface because otherwise the lift we construct will not actually be a surface. Denote the regular 2-partition groupoid covering $[a, b] \times [\delta, \delta']$ and contained in \mathfrak{h} by $\tilde{\mathfrak{q}} \times \tilde{\mathfrak{p}}$. Here we use the notation of the proof of lemma 2.70 and the preceding discussion, and reproduce the diagram from that lemma for reference

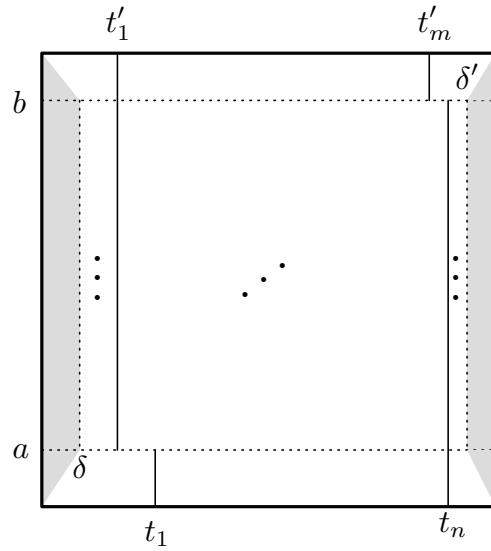

The surface f is lifted as follows: lift the ‘vertical borders’ (as in the picture) to be constant at the endpoints $\gamma_0(0)$ and $\gamma_0(1)$ of γ . Now lift the rest of $\tilde{\mathfrak{q}} \times \tilde{\mathfrak{p}}$ as is given by lemma 2.119. Considering the resulting paths $\{a^\pm\} \times \mathfrak{q} \rightarrow Y[U]$, there is a natural transformation (namely the identity) between their composites with q . Since q is fully faithful, this lifts to a unique natural transformation, which provides the arrow component of the lift at $s = (a^-, a^+)$. A similar argument can be used for $s = (b^-, b^+)$. All that remains is to remark that the paths $\tilde{\mathfrak{q}} \times \{\delta^+\} \rightarrow Y[U]$ and $\tilde{\mathfrak{q}} \times \{\delta^-\} \rightarrow Y[U]$, the latter of which factors through a point, map to the codiscrete groupoid which is the fibre over $q \circ \gamma_0(0)$. There is thus a natural transformation between them, by lemma 2.114, which provides the arrow component of the lift for the arrows at $t = (\delta^-, \delta^+)$. Similarly for the arrows at $t = (\delta'^-, \delta'^+)$. Thus we have a lift of a surface homotopic to our original surface, and q_* is locally full.

REMARK 2.121. It should be clear that given a pair of collared surfaces between a pair of paths, if they are homotopic we can find a homotopy that is through collared surfaces, such that width of the ‘margin’ is uniform in the r -direction. It is homotopies of this sort – also called collared – that we shall use for the next part of the proof. Notice that the complement of the collar in the 3-partition is regular: it

is of the form $\tilde{\mathfrak{p}}_1 \times \tilde{\mathfrak{p}}_2 \times \tilde{\mathfrak{p}}_3$ for a partition $\tilde{\mathfrak{p}}_3$ of $[\delta, \delta']$ and so on. This will be referred to again as the *regular part* of \mathfrak{H} .

Now given a pair of surfaces $f_\epsilon: \mathfrak{h}_\epsilon \rightarrow Y[U]$ between the paths $\gamma_\epsilon: \mathfrak{p}_\epsilon \rightarrow Y[U]$, consider the surfaces $q \circ f_\epsilon: \mathfrak{h}_\epsilon \rightarrow Y$. We can assume that $\mathfrak{h}_0 = \mathfrak{h}_1 = \mathfrak{h}$, because otherwise we could form the common refinement, which does not affect the domains of the 1-source and 1-target. We can also assume the f_0, f_1 are collared. If $[q \circ f_0] = [q \circ f_1]$, i.e. there is a homotopy $F: \mathfrak{H} \rightarrow Y$ from $q \circ f_0$ to $q \circ f_1$, we want to show that this homotopy lifts to a homotopy between f_0 and f_1 . By remark 2.121, we can assume that F is collared. We can lift the regular part of \mathfrak{H} as per lemma 2.119. The part of F that is constant in the inward direction can be lifted to be constant on the preimage of the relevant boundary. In exactly the same way as we did for lifting surfaces, the arrows that are between the objects in the collar and the objects in the regular part of \mathfrak{H} are sent to the uniquely defined lifts of the identity arrows, using the full faithfulness of q . Thus there is a homotopy between f_0 and f_1 and thus $[f_0] = [f_1]$ i.e. q_* is faithful, and we are done. \square

Thus to an anafunctor $Y \xleftarrow{q} Y[U] \rightarrow X$, we can associate, using the axiom of choice to get a pseudoinverse for q_* , a weak 2-functor $\Pi_2(Y) \rightarrow \Pi_2(X)$.

REMARK 2.122. In this instance, we cannot apply theorem 1.82, as we are considering the 1-category **Bigpd** of bigroupoids and strict 2-functors, and equivalences of bigroupoids are not weakly invertible until we consider the full 3-category of bigroupoids, 2-functors, pseudonatural transformations and modifications. Even if we were to use the full 3-category, there is no published account of the theory of localisations of 3-categories – there is only the talk [Pro07] which discusses the basics of such a program. Speaking heuristically for a moment, it seems there is a need for a theory of weak localisation somewhere between that considered by Gabriel-Zisman and Dwyer-Kan localisation, which is essentially a localisation of a category to an $(\infty, 1)$ -category. Examples include localising a category so that a specified class of morphisms are sent to equivalences in some $(2, 1)$ -category¹², or as is the case here, localising a 2-category such that the specified class of morphisms is sent to internal equivalences in some $(3, 2)$ -category.

Will we now show directly that weak equivalences are sent to equivalences of bigroupoids, via a sequence of preparatory technical lemmas.

¹²The case in which Pronk's localisation is applicable is precisely when the Gabriel-Zisman category of fractions exists, and gives an equivalent result to Gabriel-Zisman. What is needed is a construction of a localisation that exists, barring set-theoretic difficulties, for all classes of weak equivalences.

LEMMA 2.123. *Let*

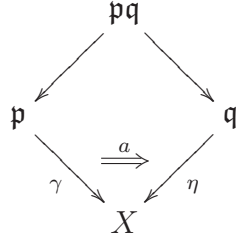

be an arrow in $\text{Path}(X)$, and define $\gamma' := \gamma[\mathbf{pq}]$, $\eta' = \eta[\mathbf{pq}]$. Then there is a surface $|a|: \mathfrak{h} \rightarrow X$ such that

$$|a|_{s=1} = (\eta'(1), \eta, \eta'(0)),$$

a 3-ary composition, and $s_1(|a|) := |a|_{s=0}$ is given by

$$s_1(|a|)(t) = \begin{cases} \eta'(0) & t \in [0, \frac{1}{3}^-], \\ \gamma(3t - 1) & t \in [\frac{1}{3}^+, \frac{2}{3}^-], \\ \eta'(1) & t \in [\frac{2}{3}^+, 1] \end{cases}$$

on objects and

$$s_1(|a|)(t^x, t^{x'}) = \begin{cases} a_0^{-1} & (t^x, t^{x'}) = (\frac{1}{3}^-, \frac{1}{3}^+), \\ a_1 & (t^x, t^{x'}) = (\frac{2}{3}^-, \frac{2}{3}^+), \\ \gamma(t^x, t^{x'}) & \text{otherwise} \end{cases}$$

on arrows.

Proof. The construction of $|a|$ is given in the following picture

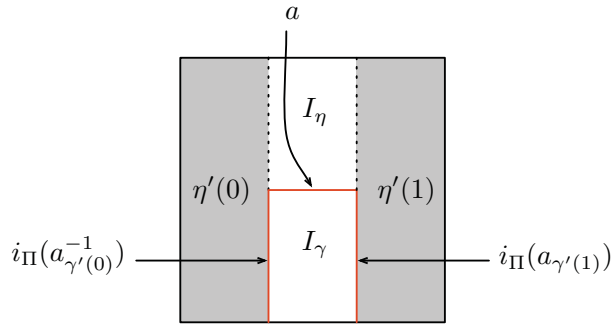

The values of $|a|$ on the arrows on the red lines are given by components of the transformation a as indicated. \square

COROLLARY 2.124. *Given an arrow a in $\text{Path}(X)$ as in the previous lemma, and the resulting surface $|a|$, there is a surface from $s_1(|a|)$ to η .*

Proof. Just compose the surface from the lemma with an obvious modification of the unitor to a double sided version (or a left unitor then a right unitor, scaled appropriately). \square

The case in which we shall use this is when $\mathbf{p} \rightarrow \mathbf{q}$ is a refinement, and so $\mathbf{pq} = \mathbf{p}$. The next result is essentially the same, but one dimension higher.

LEMMA 2.125. *Let*

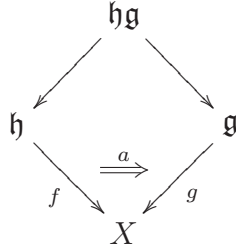

be a transformation where g is a surface from $\gamma_0: \mathfrak{p}_0 \rightarrow X$ to $\gamma_1: \mathfrak{p}_1 \rightarrow X$ such that $\gamma_0(\epsilon) = x_\epsilon$ for $\epsilon = 0, 1$. Then there are homotopic surfaces

$$\begin{aligned} |f|: |\mathfrak{h}| &\rightarrow X, \\ |g|: |\mathfrak{g}| &\rightarrow X, \end{aligned}$$

where $|\mathfrak{h}|$ and $|\mathfrak{g}|$ are given by the pictures

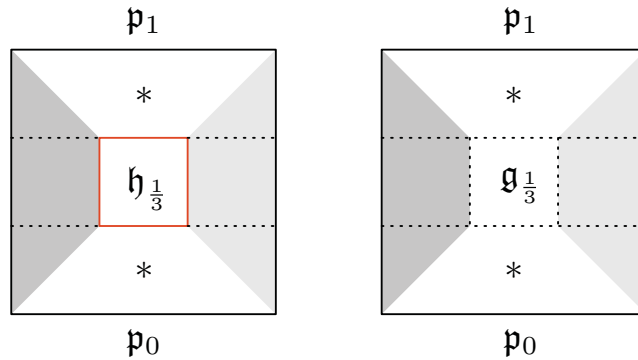

where the red boundary of \mathfrak{h} indicates that the value of $|f|$ on the arrows there are given by the transformation a restricted to the boundary, the rectangular regions marked with $*$ are two-sided versions of the unitors, and the subscript $\frac{1}{3}$ means that the 2-partition groupoid is scaled by one-third in both directions, and so are the functors f and g . Also, for $(s, t) \notin [\frac{1}{3}^+, \frac{2}{3}^-] \times [\frac{1}{3}^+, \frac{2}{3}^-]$, we have $|f|(s, t) = |g|(s, t)$.

Proof. The domain of the homotopy (call it $|a|$) is $|\mathfrak{h}| * |\mathfrak{g}|$. On the subgroupoids $[0, \frac{1}{2}^-] \times |\mathfrak{h}|$ and $[\frac{1}{2}^+, 1] \times |\mathfrak{g}|$ we have

$$\begin{aligned} |a|_{|[0, \frac{1}{2}^-] \times |\mathfrak{h}|}(r, s, t) &= |f|(s, t) \\ |a|_{|[\frac{1}{2}^+, 1] \times |\mathfrak{g}|}(r, s, t) &= |g|(s, t) \end{aligned}$$

On the arrows $(\frac{1}{2}^-, \frac{1}{2}^+; s^x, s^x; t^\rho, t^\rho)$ we have $|a|(\frac{1}{2}^-, \frac{1}{2}^+; s^x, s^x; t^\rho, t^\rho) = a_{(s^x, t^\rho)}$. A picture of $|a|$ looks like

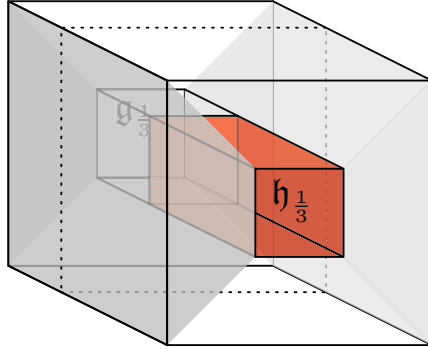

□

COROLLARY 2.126. *Given the transformation a , there is a homotopy from $|f|$ to g .*

Proof. Just take the homotopy $|a|$ from the proof of the lemma and amalgamate this in the r -direction with a four-sided version of a unitor, giving the required homotopy. □

PROPOSITION 2.127. *If $f: X \rightarrow Y$ is a weak equivalence, $f_*: \Pi_2(X) \rightarrow \Pi_2(Y)$ is an equivalence of bigroupoids.*

Proof. Firstly, as f is essentially surjective, for each object $y \in Y_0 = \Pi_2(Y)_0$ there is an arrow $\kappa: y \rightarrow f(x)$ for some $x \in X_0 = \Pi_2(X)_0$, and hence a path $i_\Pi(\kappa): \mathfrak{d} \rightarrow Y$ from y to $f(x)$. Thus f_* is essentially surjective on objects.

Next, there is an anafunctor pseudoinverse $(U, \bar{f}): Y \rightrightarrows X$ for f , so there is a diagram

(16)

$$\begin{array}{ccc}
 & X & \\
 \bar{f} \nearrow & \Downarrow & \searrow f \\
 Y[U] & \xrightarrow{a} & Y
 \end{array}$$

Any path $\gamma: \mathfrak{p} \rightarrow Y$ with source $f(x_0)$ and target $f(x_1)$ has a refinement $\gamma[\mathfrak{p}']: \mathfrak{p}' \rightarrow X$ that factors through $Y[U]$. There is then a natural transformation from $f \circ \bar{f} \circ \gamma[\mathfrak{p}']$ to $\gamma[\mathfrak{p}']$, which is an arrow

$$\begin{array}{ccc}
 & \mathfrak{p}' & \\
 & \Downarrow & \searrow \\
 \mathfrak{p}' & & \mathfrak{p} \\
 \gamma' \downarrow & \xrightarrow{a} & \downarrow \gamma \\
 Y[U] & \xrightarrow{f \circ \bar{f}} & Y
 \end{array}$$

in $\text{Path}(Y)$. This arrow defines a surface $|a|$ from the path $(i_\Pi(a_{\gamma(1)}), f \circ \bar{f} \circ \gamma[\mathfrak{p}'], i_\Pi(a_{\gamma(0)}^{-1}))$ to γ by corollary 2.124. Let $\eta = s_1(|a|)$, which written out explicitly

is

$$\eta(t) = \begin{cases} f(x_0) & t \in [0, \frac{1}{3}^-], \\ f \circ \bar{f} \circ \gamma[\mathbf{p}'](3t - 1) & t \in [\frac{1}{3}^+, \frac{2}{3}^1], \\ f(x_1) & t \in [\frac{2}{3}^+, 1] \end{cases}$$

on objects and

$$\eta(t^x, t^{x'}) = \begin{cases} a_0^{-1} & (t^x, t^{x'}) = (\frac{1}{3}^-, \frac{1}{3}^+), \\ a_1 & (t^x, t^{x'}) = (\frac{2}{3}^-, \frac{2}{3}^+), \\ f \circ \bar{f} \circ \gamma[\mathbf{p}'](t^x, t^{x'}) & \text{otherwise} \end{cases}$$

on arrows. Since f is fully faithful, there are unique lifts of a_0^{-1} and a_1 to X , so that there is a lift of η to X . Since η is in the image of f_* , we have the result that f_* is locally essentially surjective.

We now need to prove that f_* is locally fully faithful. To prove f_* is locally full we can use, *mutatis mutandis*, corollary 2.126, the two-dimensional version of corollary 2.124.

Let $[g_0], [g_1]$ be a pair of 2-tracks in X such that $[f \circ g_0] = [f \circ g_1]$. There is thus some collared homotopy $F: \mathfrak{H} \rightarrow Y$ between from $f \circ g_0: \mathfrak{h}_0 \rightarrow Y$ to $f \circ g_1: \mathfrak{h}_1 \rightarrow Y$ for representatives g_0, g_1 . We want to lift this homotopy to X . Without loss of generality we can pick collared representatives of the 2-tracks and also of the homotopy. Denote by x_0 and x_1 the 0-source and 0-target of $[g_0]$ (which are also the 0-source and 0-target of $[g_1]$). Pick a refinement $\mathfrak{H}' \rightarrow \mathfrak{H}$ such that F lifts to $Y[U]$,

$$\begin{array}{ccc} \mathfrak{H}' & \xrightarrow{F'} & Y[U] \\ \downarrow & & \downarrow \\ \mathfrak{H} & \xrightarrow{F} & Y \end{array}$$

We then define a collared homotopy $|F'|: |\mathfrak{H}'| \rightarrow X$ in the following way. The 3-partition groupoid $|\mathfrak{H}'|$ is derived from \mathfrak{H}' in a way analogous to the definition of $|\mathfrak{h}|$ and $|\mathfrak{g}|$ in the statement of lemma 2.125. The following picture gives the general idea

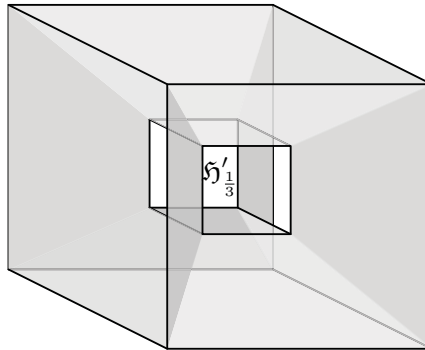

The subgroupoid $\mathfrak{H}'_{\frac{1}{3}}$ is isomorphic to \mathfrak{H}' , but is scaled by one third, and the boundary $\partial|\mathfrak{H}'|$ is identical with $\partial\mathfrak{H}$. The inner boundary of the collar is a scaled down version of $\partial|\mathfrak{H}'|$. Thus the groupoid $\partial\mathfrak{H}'_{\frac{1}{3}}$ can be considered as a ‘refinement’ of $\partial\mathfrak{H}'$.

On $\partial|\mathfrak{H}'|$ we define $|F'|$ piecewise

$$|F'|(r, s, t) = \begin{cases} x_0 & \text{when } t = 0, \\ x_1 & \text{when } t = 1, \\ g_0|_{s=0}(t) = g_1|_{s=0}(t) & \text{when } s = 0, \\ g_0|_{s=1}(t) = g_1|_{s=1}(t) & \text{when } s = 1, \\ g_0(s, t) & \text{when } r = 0, \\ g_1(s, t) & \text{when } r = 1. \end{cases}$$

Restricting to $r \in [0, \frac{1}{3}^-]$, $|F'|$ is defined to be the four-sided unitor as in the proof of corollary 2.126, and the same for $r \in [\frac{2}{3}^+, 1]$. This gives us the definition of $|F'|$ on the subgroupoid corresponding to the inner boundary of the collar as a scaled version of definition on the boundary $\partial|\mathfrak{H}'|$. Then on the subgroupoid $\mathfrak{H}'_{\frac{1}{3}}$ we define $|F'|$ to be a scaled version of $\bar{f} \circ F'$. Now using the fact that the boundary $\partial\mathfrak{H}'_{\frac{1}{3}}$ is a refinement of the boundary $\partial|\mathfrak{H}'|$, we get the following diagram

$$\begin{array}{ccc} \partial\mathfrak{H}'_{\frac{1}{3}} & \xrightarrow{\cong} & \partial\mathfrak{H}' \\ \downarrow j & & \downarrow i \\ \partial|\mathfrak{H}'| & \hookrightarrow & \mathfrak{H} \longleftarrow \mathfrak{H}' \\ \downarrow |F'| & \text{(1)} & \downarrow F \\ X & \xrightarrow{f} & Y \\ & & \downarrow q \\ & & Y[U] \\ & \searrow f' & \\ & & \downarrow F' \end{array}$$

The square marked (1) commutes by the definitions of F and $|F'|$. Thus there is a natural transformation between $f \circ |F'| \circ j$ and $f \circ f' \circ F' \circ i$, where in an abuse of notation we have suppressed the isomorphism in the top row of the diagram. The composite $f' \circ F' \circ i$ is how we have defined $|F'|$ on $\partial\mathfrak{H}'_{\frac{1}{3}}$, and so we define $|F'|$ on the arrows that have source a point in $\mathfrak{H}'_{\frac{1}{3}}$ and target in the collar of $|\mathfrak{H}'|$ to be the unique lift of the components of this natural transformation, using the full faithfulness of f . Thus we have a homotopy between g_0 and g_1 and we have $[g_0] = [g_1]$, implying f_* is locally faithful. We have now shown that the 2-functor f_* is an equivalence of bigroupoids. \square

The following theorem is the main result of this chapter, summarising everything covered up to this point.

THEOREM 2.128. *There are functors and equivalence-valued natural transformations making the following commute*

$$\begin{array}{ccc}
 \mathbf{Gpd} & \xrightarrow{\quad} & TG_0 \xleftarrow{\text{disc}} \mathbf{Top} \\
 & \searrow & \downarrow \Pi_2 \\
 & & \mathbf{Bigpd} \\
 & \swarrow & \uparrow \Pi_2^T \\
 & & \mathbf{Bigpd}
 \end{array}$$

Moreover, Π_2 sends weak equivalences in TG_0 to equivalences of bigroupoids.

Recall the universal G -bundle $EG \rightarrow BG$ is defined as a G -bundle such that EG is contractible, implying that the classifying space BG is defined up to homotopy. Given two models BG and \widetilde{BG} for the classifying space of G , there is a homotopy equivalence between them. This implies that $\Pi_2^T(BG)$ is equivalent to $\Pi_2^T(\widetilde{BG})$. If G has a non-degenerate identity, that is, the inclusion $\text{id}: * \rightarrow G$ is a closed cofibration,¹³ then one model for BG is the geometric realisation of the nerve of \mathbf{BG} [Seg68]. For now, choose any universal G -bundle, and call it $EG \rightarrow BG$.

We would like to obtain a homotopical relationship between the groupoid \mathbf{BG} and the space BG . We shall do this by establishing a zig-zag of equivalences of fundamental bigroupoids. Consider first the span

$$\begin{array}{ccc}
 & EG \rtimes G & \\
 & \swarrow & \searrow \\
 \text{disc}(BG) & & \mathbf{BG}
 \end{array}$$

where $EG \rtimes G$ is the action groupoid (as opposed to the semidirect product). Now since the universal G -bundle $EG \rightarrow BG$ admits local sections, the functor

$$(17) \quad EG \rtimes G \rightarrow EG/G \simeq BG$$

is essentially \mathcal{O} -surjective. Also, the map $EG \times G \rightarrow EG \times_{BG} EG$ is an isomorphism, which is the same thing as saying the functor (17) is fully faithful. However, the functor $EG \rtimes G \rightarrow \mathbf{BG}$ is not full, so is not a weak equivalence. This means we have a map $\text{disc}(BG) \dashrightarrow \mathbf{BG}$ in $\mathbf{Ana}(\mathbf{Top})$ which is not an equivalence. Applying the fundamental bigroupoid functor we get a span of bigroupoids

$$\begin{array}{ccc}
 & \Pi_2(EG \rtimes G) & \\
 & \swarrow & \searrow \\
 \Pi_2(\text{disc}(BG)) & & \Pi_2(\mathbf{BG})
 \end{array}$$

However, the bigroupoid $\Pi_2(\text{disc}(BG))$ has an equivalent (much smaller) sub-bigroupoid, namely $\Pi_2^T(BG)$. Hence choosing a pseudoinverse for the left leg of the above span

¹³This is always the case when G is a Lie group.

we have a comparison 2-functor

$$\Pi_2^T(BG) \rightarrow \Pi_2(\mathbf{BG})$$

which we will show is an equivalence.

PROPOSITION 2.129. *The functor $t : EG \times G \rightarrow \mathbf{BG}$ induces an equivalence on fundamental bigroupoids.*

Proof. Obviously t_* is surjective on objects. For $x, y \in EG$. we want to show

$$t_{*,xy} : \Pi_2(EG \times G)(x, y) \rightarrow \Pi_2(\mathbf{BG})(*, *)$$

is an equivalence of groupoids for arbitrary $x, y \in EG$. Let us just first point out that given a pair of objects of EG , an arrow between them (if one exists) is just an element of G .

First, we shall show that $t_{*,xy}$ is surjective on objects. Let \mathfrak{p} be the partition groupoid given by $\{t_1, \dots, t_n\}$ and $\eta : \mathfrak{p} \rightarrow \mathbf{BG}$ be a path such that the sequence of arrows (i.e. elements of G) $\eta_1(t_i)$ is denoted g_1, \dots, g_n . We shall say this more succinctly as: η is given by the data $(\mathfrak{p}; g_1, \dots, g_n)$. Choose a path $\gamma^0 : I \rightarrow EG$ from x to $yg_n^{-1}g_{n-1}^{-1} \cdots g_1^{-1}$. Define a path inductively as follows: given γ^{k-1} , let $\gamma^k : \mathfrak{p} \rightarrow EG \times G$ agree with γ^{k-1} on the subgroupoid $\mathfrak{p}[0, t_k] \subset \mathfrak{p}$. On objects, set

$$\gamma_0^k|_{[t_i, i+1]} = \gamma_0^{k-1}|_{[t_i^+, t_{i+1}^-]} g_k, \quad i = k, \dots, n,$$

On arrows let $\gamma_1^k(t_k)$ correspond to the group element g_k and let $\gamma_1^k(t_i)$ be the identity arrow $\text{id}_{\gamma_1^0(t_i)g_1 \dots g_k}$ for all $k < i \leq n$. A picture of this construction is as follows:

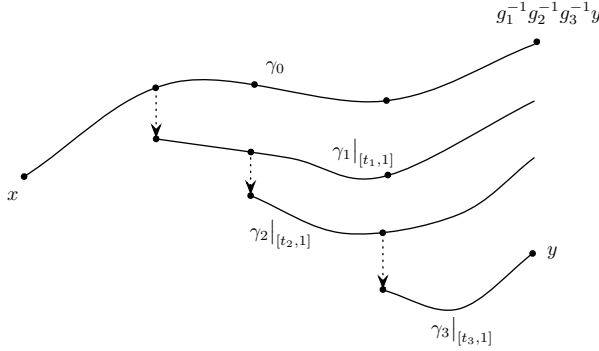

It is clear that the image of γ_n under $t_{*,xy}$ is just η , and so t_* is locally surjective.

Now consider two paths γ_0, γ_1 in $\Pi_2(EG \times G)(x, y)$, and let $\eta_\epsilon = t_{*,xy}(\gamma_\epsilon)$. Let $f : \mathfrak{h} \rightarrow \mathbf{BG}$ be a collared surface representing a 2-track from η_0 to η_1 , with sitting instants for $s \in [0, a]$, $s \in [b, 1]$ and $t \in [0, \delta]$, $t \in [\delta', 1]$. Denote the regular part of \mathfrak{h} by $\tilde{\mathfrak{q}} \times \tilde{\mathfrak{p}}$. Since f is collared, we can lift on the collar C , to get a functor

$$\lambda|_C(s, t) = \begin{cases} \gamma_0(t) & s \in [0, a] \\ \gamma_1(t) & s \in [b, 1] \\ x & t \in [0, \delta] \\ y & t \in [\delta', 1] \end{cases}$$

We define λ on the boundary of the regular part to factor through the restriction of $\lambda|_C$ to the inner boundary, and on the arrows between the objects in the collar

and the objects in the regular part we define λ to take values in the identity arrows. All we then need to do is define the lift on the regular part. What we have is the following diagram

$$\begin{array}{ccc}
 \partial(\tilde{\mathfrak{q}} \times \tilde{\mathfrak{p}}) & \xrightarrow{\lambda} & EG \rtimes G \\
 \downarrow & \nearrow \text{---} & \downarrow t \\
 \tilde{\mathfrak{q}} \times \tilde{\mathfrak{p}} & \xrightarrow{f} & BG
 \end{array}$$

and would like to find a functor as indicated. Let the partition $\tilde{\mathfrak{p}} \rightarrow [\delta, \delta']$ be given by $\{t_1, \dots, t_n\}$.

First assume that $\tilde{\mathfrak{q}} = I$. Then the surface f is given by the data $(\mathfrak{h}; \sigma_1, \dots, \sigma_n)$ where the σ_i are paths in G .

$$\begin{array}{ccc}
 \begin{array}{c} \gamma_1 \\ \boxed{} \\ \gamma_0 \end{array} & \mapsto & \begin{array}{c} \eta_1 \\ \boxed{\sigma_1 \mid \sigma_2 \cdots \mid \sigma_n} \\ \eta_0 \end{array} \\
 EG \rtimes G & & BG
 \end{array}$$

We will define a surface from γ_0 to γ_1 . First, choose a path $\rho_1^- : I \rightarrow EG$ from $\gamma_0(t_1^-)$ to $\gamma_1(t_1^-)$. Then define $\rho_1 = (\rho_1^-, \sigma_1) : I \rightarrow EG \times G$. As EG is simply-connected, we can fill the loop defined by the 3-ary concatenation $(\gamma_0|_{[0, t_1]}, \rho_1^-, \overline{\gamma_1|_{[0, t_1]}})$ (as paths in a space, not as paths in a groupoid).

$$\begin{array}{ccc}
 \begin{array}{c} \gamma_1 \\ \boxed{\rho_1 \mid } \\ \gamma_0 \end{array} & \mapsto & \begin{array}{c} \eta_1 \\ \boxed{\sigma_1 \mid \sigma_2 \cdots \mid \sigma_n} \\ \eta_0 \end{array} \\
 EG \rtimes G & & BG
 \end{array}$$

Letting $\rho_1^+(s) = \rho_1^-(s)\sigma_1(s)$, using the action of G on EG , gives us a path from $\gamma_0(t_1^+)$ to $\gamma_1(t_1^+)$. This process can be repeated, joining $\gamma_0(t_i^-)$ to $\gamma_1(t_i^-)$ by a path ρ_i^- and defining $\rho_i^+(s) = \rho_i^-(s)\sigma_i(s)$ until we get to $\rho_n^+ : I \rightarrow EG$, which gives a loop

$$(\rho_n^+, \overline{\gamma_1|_{[0, t_1]}}, \gamma_0|_{[t_n, 1]})$$

in EG (again, this concatenation is as paths in a space). Since EG is simply connected, we can fill this loop and so we have defined a surface that lifts f .

For the general case, we shall proceed by induction on the number of connected components of $\tilde{\mathfrak{q}}$. Let the partition $\tilde{\mathfrak{q}} \rightarrow [a, b]$ be given by $\{s_1, \dots, s_m\}$. We can

lift the path $f(s_1^-, -): \tilde{\mathfrak{p}} \rightarrow \mathbf{BG}$ to a path $\lambda_1^- = (\lambda_{1,1}^-, \lambda_{1,2}^-): \tilde{\mathfrak{p}} \rightarrow EG \rtimes G$ with endpoints x and Y by the first part of the proof. This gives us the situation

$$\begin{array}{ccc} \partial([a, s_1^-] \times \tilde{\mathfrak{p}}) & \longrightarrow & EG \rtimes G \\ \downarrow & \nearrow \text{dashed} & \downarrow t \\ [a, s_1^-] \times \tilde{\mathfrak{p}} & \longrightarrow & \mathbf{BG} \end{array}$$

where we can lift as indicated by the argument of the previous paragraph. Then for the arrows $(s_1^-, s_1^+; t^x, t^x)$ set $\lambda(s_1^-, s_1^+; t^x, t^x) = (\lambda_{1,1}^-(t^x), f(t^x))$, and let $\lambda_1^+(t) = \lambda_{1,1}^-(t)f(t)$. The resulting path $\lambda_1^+: \tilde{\mathfrak{p}} \rightarrow EG \rtimes G$ lifts $f(s_1^+, -)$ and we can now repeat the procedure starting with the path $f(s_2^-, -)$. This can continue until we have reduced to the case of finding a lift of f over $[s_m, b] \times \tilde{\mathfrak{p}}$, but this was the first case we treated, which means we can find this lift, and hence we have a surface $\lambda: \mathfrak{h} \rightarrow EG \rtimes G$ lifting f , and so t_* is locally full.

Now consider 2-tracks $[f_\epsilon]: \gamma_0 \Rightarrow \gamma_1$ in $EG \rtimes G$ for $\epsilon = 0, 1$, with collared representatives $f_\epsilon: \mathfrak{h} \rightarrow EG \rtimes G$ (recall that this is no loss of generality to take the domains to be equal, as we could otherwise pass to a common refinement). Let $F: \mathfrak{H} \rightarrow \mathbf{BG}$ be a homotopy from $t \circ f_0$ to $t \circ f_1$, which we can assume is collared. We shall define a lift $\Phi: \mathfrak{H} \rightarrow EG \rtimes G$ of F . The surfaces f_ϵ give us Φ on $\mathfrak{H}|_{r=\epsilon}$, and we set $\Phi(r, \epsilon, t) = \gamma_\epsilon(t)$, $\Phi(r, s, \epsilon) = \gamma_0(\epsilon)$. Define Φ on the collar to be constant in the inward direction, and extend this to the boundary $\partial(\prod_{i=1}^3 \mathfrak{p}_i)$ of the regular part $\prod_{i=1}^3 \mathfrak{p}_i$ of \mathfrak{H} by letting $\Phi|_{\partial(\prod_{i=1}^3 \mathfrak{p}_i)}$ factor through $\partial\mathfrak{H}$. Then we only need to lift F on the regular part of \mathfrak{H} , as shown:

$$\begin{array}{ccc} \partial(\prod_{i=1}^3 \mathfrak{p}_i) & \xrightarrow{\Phi|_{\partial(\prod_{i=1}^3 \mathfrak{p}_i)}} & EG \rtimes G \\ \downarrow & \nearrow \text{dashed} & \downarrow \\ \prod_{i=1}^3 \mathfrak{p}_i & \xrightarrow{F} & \mathbf{BG} \end{array}$$

From here we shall proceed a little more conceptually. Given a 3-partition groupoid \mathfrak{H} and a functor $F: \mathfrak{H} \rightarrow \mathbf{BG}$, the regions of \mathfrak{H} are all mapped to the point, and the only non-trivial data we are left with are the maps $F_{12}: [a, b] \times [c, d] \rightarrow G$, the arrow components of F on the intersection of two neighbouring regions R_1, R_2 . If we are given a lift Φ_1 of F to $EG \rtimes G$ on the region R_1 , i.e. on the objects of \mathfrak{H} in R_1 , then we can lift the arrow components of F on the arrows in $R_1 \cap R_2 = [a, b] \times [c, d]$ by setting the lifted functor to be $(\Phi_1|_{R_1 \cap R_2}, F_{12})$. The targets of these arrows are given by $\Phi_1|_{R_1 \cap R_2} F_{12}$ with the G -action taken pointwise. This gives us a starting point in EG to lift F on the region R_2 .

Now to define a lift of F on a given region R , we often have already defined a lift on a subset of the boundary ∂R , but sometimes all of ∂R . Since EG is contractible, there is no problem in choosing a lift extending any given lift. By the above paragraph we only need to consider regular \mathfrak{H} . Number the regions in $\prod_{i=1}^3 \mathfrak{p}_i$ as follows. If \mathfrak{p}_i is given by $\{t_1^{(i)}, \dots, t_{n_i}^{(i)}\}$, where we also implicitly set $t_0^{(i)} = 0$, then denote $[t_k^{(1)}, t_{k+1}^{(1)}] \times [t_l^{(2)}, t_{l+1}^{(2)}] \times [t_m^{(3)}, t_{m+1}^{(3)}]$ by (k, l, m) . Order the regions lexicographically:

$$\begin{aligned} & (0, 0, 0) \\ & (0, 0, 1) \\ & \vdots \\ & \vdots \\ & (n_1, n_2, n_3) \end{aligned}$$

Now lift F region by region in this order, remembering that giving a lift of F on region (a, b, c) defines lifts of the adjacent faces of regions $(a+1, b, c)$, $(a, b+1, c)$ and $(a, b, c+1)$, as well as the arrows between them. Since \mathfrak{H} is a poset, the fact that the lift is a functor follows from our definition of the arrows components. Given the lifted homotopy Φ , we see that t_* is locally fully faithful, and so $t_*: \Pi_2(EG \rtimes G) \rightarrow \Pi_2(\mathbf{BG})$ is an equivalence. \square

PROPOSITION 2.130. *Let G be a topological group. There is a zig-zag of equivalences of bigroupoids*

$$\Pi_2^T(\mathbf{BG}) \xrightarrow{\sim} \Pi_2(\text{disc}(\mathbf{BG})) \xleftarrow{\sim} \Pi_2(EG \rtimes G) \xrightarrow{\sim} \Pi_2(\mathbf{BG}),$$

natural with respect to functors $EG \rtimes G \rightarrow EH \rtimes H$.

This can be viewed as evidence that we have made the right choices as to the definition of Π_2 , since it gives here the expected homotopy 2-type of \mathbf{BG} .

Note that we have an example of a functor which is not a weak equivalence, but induces an equivalence of fundamental bigroupoids. This indicates that the bicategory $\mathbf{Ana}(\mathbf{Top})$ cannot be considered as a ‘homotopy bicategory’ of TG , and if one wants a bicategory of topological groupoids where (weak) homotopy equivalences were weakly invertible, more work needs to be done. This will not concern us further at present.

We end the chapter with a couple of conjectures about the behaviour of Π_2 on groupoids of a particular sort. For any groupoid X there is a space EX equipped with a homotopy equivalence $\omega: EX \rightarrow X_0$ and a free action $EX \times_{X_0, s} X_1 \rightarrow EX$. This means that if $\omega(p) = x = s(a)$, then $\omega(pa) = t(a)$ for $a \in X_1$. For suitably nice X (such as if $X_0 \rightarrow X_1$ is a closed cofibration over $X_0 \times X_0$), EX is given by the geometric realisation of the nerve of the *tangent groupoid* TX (see definition 4.28). The quotient of EX by this action, $BX = EX/X$ is a version of the classifying space of X . Again if X is nice, BX is the geometric realisation of the nerve of X . For more general groupoids, something like the realisation in [WS06], section 3, or [Noo], or the fat realisation from [Seg74], will need to be used. We shall make the assumption

that a model of $EX \rightarrow BX$ can be chosen such that this map admits local sections (this seems very likely for the model in [WS06], given that it is modelled on the Milnor construction of the universal G -bundle). The space EX is then a principal X bundle, or an X -torsor, called the universal X -bundle. We can form the action groupoid $EX \rtimes_{X_0} X$, which comes equipped with a functor to $\text{disc}(BX)$. This functor is a weak equivalence, for the same reasons that $EG \rtimes G \rightarrow BG$ is a weak equivalence for G a topological group. We thus know by proposition 2.127 that $\Pi_2(EX \rtimes_{X_0} X) \rightarrow \Pi_2(\text{disc}(BX))$ is an equivalence of bigroupoids, and also we have an equivalence $\Pi_2^T(BX) \rightarrow \Pi_2(\text{disc}(BX))$ by proposition 2.118. There is a canonical functor $EX \rtimes_{X_0} X \rightarrow X$, analogous to $EG \rtimes G \rightarrow \mathbf{B}G$, which is generally not a weak equivalence.

CONJECTURE 2.131. *The functor $EX \rtimes_{X_0} X \rightarrow X$ induces an equivalence of bigroupoids $\Pi_2(EX \rtimes_{X_0} X) \rightarrow \Pi_2(X)$.*

We have already proved this conjecture for the case $X = \mathbf{B}G$ – this is proposition 2.129. The techniques for proving proposition 2.129 should apply to proving the conjecture, using the fact $EX \rightarrow X_0$ is a homotopy equivalence. Combining conjecture 2.131 with the discussion in the paragraph above there is an immediate corollary.

COROLLARY 2.132. *Given a model $EX \rightarrow BX$ of the universal X -bundle, there is an equivalence of bigroupoids $\Pi_2^T(BX) \rightarrow \Pi_2(X)$.*

The proof of the conjecture would imply that Π_2 as constructed in this chapter is *the*¹⁴ correct fundamental bigroupoid of topological groupoids, as BX is the homotopy colimit of the nerve of X and is regarded as giving the homotopy type of X . It would also imply that this would give a fundamental bigroupoid for topological stacks, as the homotopy type of a topological stack is given by the realisation of any topological groupoid presenting it [Ebe09, Noo08b]. The reader is cautioned that the cited papers make assumptions about the topology of the object and arrow spaces, and sometimes about properties of the source and target maps s and t . These assumptions are desirable, and even necessary for many results about topological stacks. The groupoids we consider in this thesis correspond to the *pretopological stacks* of [Noo08b]. The link between topological stacks and topological groupoids is not particularly utilised in this thesis though, so these assumptions have not been made here.

The second conjecture concerns a particular class of groupoids, namely those with a discrete object space. These are perhaps better known as **Top**-groupoids from the setting of enriched categories. As the reader would appreciate, paths and surfaces are a lot simpler – paths for example are simply finite sequences of arrows, as in the case of t-d groupoids.

LEMMA 2.133. *Every **Top**-groupoid X is equivalent to a **Top**-groupoid $\coprod_x \mathbf{B} \text{Aut}_X(x)$ where the coproduct is taken over representatives of isomorphism classes.*

¹⁴up to pseudonatural isomorphism

Thus we can reduce to the case of one-object groupoids, and use proposition 2.108 to calculate the fundamental bigroupoid of a **Top**-groupoid. We first mention the result of Brown-Spencer [BS76] that the fundamental groupoid of a topological group is a strict 2-group, and so is a 2-groupoid $\mathbf{B}\Pi_1(G)$ with one object.

CONJECTURE 2.134. *For the groupoid $\mathbf{B}G$, the bigroupoid $\Pi_2(\mathbf{B}G)$ is naturally equivalent to $\mathbf{B}\Pi_1(G)$.*

COROLLARY 2.135. *For a **Top**-groupoid X we have $\Pi_2(X)$ is equivalent to*

$$\coprod_x \mathbf{B}\Pi_1(\mathrm{Aut}_X(x)),$$

where the coproduct is taken over representatives for isomorphism classes.

This corollary tells us that given a choice of object from each isomorphism class of a **Top**-groupoid X , $\coprod_x \mathbf{B}\Pi_1(\mathrm{Aut}_X(x))$ is a strictification of $\Pi_2(X)$, that is, a 2-groupoid with an equivalence to $\Pi_2(X)$.

We also make a more tentative conjecture, which doesn't rely on choosing representatives for isomorphism classes.

CONJECTURE 2.136. *Let X be a **Top**-groupoid. Then the double groupoid*

$$\Pi_1(X_1) \rightrightarrows \Pi_1(X_0) = X_0$$

is a 2-groupoid and is naturally equivalent to $\Pi_2(X)$.

To finish, we remark that the conjectures also apply to any groupoid which is weakly equivalent to a **Top**-groupoid, such as *locally trivial* groupoids (see definition 4.25 and lemma 4.35).

CHAPTER 3

Interlude: Pointed topological anafunctors

Since many constructions in algebraic topology, not least the fundamental group functor, are defined on the category of pointed topological spaces, we need to define an appropriate 2-category of pointed topological groupoids. We will mimic the results of chapter 1 and show that we can localise the usual 2-category of pointed topological groupoids at a class of weak equivalences, and that a pointed version of anafunctors is (equivalent to) that localisation.

DEFINITION 3.1. The 2-category TG_* of *pointed topological groupoids, weakly pointed functors and pointed transformations* is the comma 2-category

$$TG_* = \text{disc}(\ast) \downarrow TG.$$

where \ast is the one-point topological space.

Recall that this means that the objects of TG_* are topological groupoids X with a chosen object $x: \text{disc}(\ast) \rightarrow X$, the 1-arrows are functors $f: X \rightarrow Y$ that preserve the basepoint up to a specified isomorphism $\alpha: y \rightarrow f(x)$, and the 2-arrows are natural transformations $a: (f, \alpha) \Rightarrow (g, \beta)$ such that $a_x = \beta \circ \alpha^{-1}$. Note that all natural transformations are in fact natural isomorphisms.

EXAMPLE 3.2. Given a pointed topological space (M, m) , there is clearly a pointed groupoid $(\text{disc}(M), m)$, which will be denoted by $\text{disc}(M, m)$. Any weakly pointed functor $(X, x) \rightarrow \text{disc}(M, m)$ is clearly strictly pointed. If $p: (M, m) \rightarrow (N, n)$ is a pointed map of spaces, there is a pointed groupoid $\check{C}(M, m)$, the pointed Čech groupoid of p , defined in the same way as the unpointed case, with the given basepoint. There is a canonical strictly pointed functor

$$\check{C}(M, m) \rightarrow \text{disc}(N, n).$$

REMARK 3.3. As in the unpointed case (remark 1.31), if p is a pointed regular epimorphism, any functor $\check{C}(M, m) \rightarrow \text{disc}(N', n')$ gives rise to a unique map of pointed spaces $(N, n) \rightarrow (N', n')$.

REMARK 3.4. One could define pointed groupoids internal to a general pointed category in the sense of chapter 1, but this would only lead to strictly pointed functors. As an example, \mathbf{Grp} is a pointed category, internal groupoids therein are strict 2-groups and internal functors respect the monoidal unit. If the pointed category in question is a category of pointed objects $\ast \downarrow S$, say, then one can repeat the above definition: $\mathbf{Gpd}_*(S) := \ast \downarrow \mathbf{Gpd}(S)$.

DEFINITION 3.5. A *pointed equivalence* of pointed topological groupoids is a pair of weakly pointed functors

$$(f, \alpha): (X, x) \rightarrow (Y, y), \quad (f', \alpha'): (Y, y) \rightarrow (X, x)$$

and pointed transformations

$$i: (f, \alpha) \circ (f', \alpha') \Rightarrow \text{id}_Y, \quad e: (f', \alpha') \circ (f, \alpha) \Rightarrow \text{id}_X.$$

Just as we have weak equivalences for unpointed groupoids, there are pointed weak equivalences for pointed groupoids.

DEFINITION 3.6. A weakly pointed functor $(f, \alpha): (X, x) \rightarrow (Y, y)$ is a *pointed J -equivalence* if the underlying functor is a J -equivalence. If reference to J is suppressed, we will refer to *pointed weak equivalences*. The class of pointed J -equivalences will be denoted $*W_J$.

EXAMPLE 3.7. Let $(M, m) \rightarrow (N, n)$ be a pointed J -epimorphism. Then $\check{C}(M, m) \rightarrow \text{disc}(N, n)$ is a (strictly) pointed weak equivalence.

EXAMPLE 3.8. Given an unpointed J -equivalence $f: X \rightarrow Y$, choose basepoints as needed, and the result is a pointed weak equivalence.

EXAMPLE 3.9. If (X, x) is a pointed groupoid such that $s^{-1}(x) \hookrightarrow X_1 \xrightarrow{t} X_0$ admits local sections (necessarily implying X is transitive), the natural inclusion $\mathbf{B} \text{Aut}_X(x) \rightarrow X$ is a weak equivalence.

Even though TG has all strict pullbacks (because **Top** does), TG_* does not, because the 2-categorical nature of TG plays an integral role in the definition of TG_* . There are many cases of importance to us when the strict pullback does exist, however.

Let $(f, \alpha): (X, x) \rightarrow (Z, z)$ and $(g, \beta): (Y, y) \rightarrow (Z, z)$ be weakly pointed functors such that the arrow $\alpha \circ \beta^{-1}: g(y) \rightarrow f(x)$ in Z has a lift $\widehat{\alpha \circ \beta^{-1}}: y \rightarrow y'$ in Y . Clearly, for this to exist it is necessary that $f(x)$ is in the image of g .

The strict pullback is then the pointed groupoid $(X \times_Z Y, (x, y'))$, and the functors

$$(\text{pr}_1, \text{id}): (X \times_Z Y, (x, y')) \rightarrow (X, x), \quad (\text{pr}_2, \widehat{\alpha \circ \beta^{-1}}): (X \times_Z Y, (x, y')) \rightarrow (Y, y)$$

make this diagram commute

$$\begin{array}{ccc} (X \times_Z Y, (x, y')) & \xrightarrow{(\text{pr}_2, \widehat{\alpha \circ \beta^{-1}})} & (Y, y) \\ \downarrow (\text{pr}_1, \text{id}) & & \downarrow (g, \beta) \\ (X, x) & \xrightarrow{(f, \alpha)} & (Z, z) \end{array}$$

Some cases when the strict pullback exists are: when f and g are strictly pointed, or more generally when $\alpha = \beta$, or when g is full and surjective on objects. The weak

pullback of pointed groupoids is much more natural and always exists. It can be written, however, as a strict pullback, the same as the unpointed case (definition 1.86). One example of a strict pullback we will use is constructed as follows.

Given a pointed space (M, m) there is a pointed groupoid $\text{codisc}(M, m)$ with object space M , arrow space $M \times M$ and the two projections as source and target. A pointed map gives rise to a strictly pointed functor between such groupoids. Note that for a pointed groupoid (X, x) , there is a strictly pointed functor $(X, x) \rightarrow \text{codisc}(X_0, x)$ which is the identity on objects, and sends an arrow η to the pair $(s\eta, t\eta)$.

DEFINITION 3.10. Let (X, x) be a pointed groupoid, and $(M, m) \rightarrow (X_0, x)$ a pointed map of spaces. The *induced groupoid* $X[M, m]$ is defined as the following strict pullback

$$\begin{array}{ccc} X[M, m] & \longrightarrow & (X, x) \\ \downarrow & \lrcorner & \downarrow \\ \text{codisc}(M, m) & \longrightarrow & \text{codisc}(X_0, x) \end{array}$$

in analogy to the unpointed case (definition 1.51).

We are most interested in the case when M is a cover of X_0 , but a basepoint needs to be specified. To that end we make the following definition. Let J be a subcanonical singleton pretopology on **Top**.

DEFINITION 3.11. A *pointed J -cover*, or J_* -cover, of a pointed space (M, m) is a cover $U \rightarrow M$ in the pretopology J and a lift $m_U \in U$ of the basepoint m .

If $(U, x_U) \rightarrow (X_0, x)$ is a J_* cover, then $X[U, x_U] \rightarrow (X, x)$ is a pointed weak equivalence. Many other results from chapter 1 carry over into the pointed setting. The following we give without proof, as they follow from the same results in chapter 1, and remembering that $X[U, x_U] \rightarrow (X, x)$ is strictly pointed.

LEMMA 3.12. *The following is a strict pullback*

$$\begin{array}{ccc} X[M \times_{X_0} N, (m, n)] & \longrightarrow & X[N, n] \\ \downarrow & & \downarrow \\ X[M, m] & \longrightarrow & (X, x) \end{array}$$

LEMMA 3.13. *The strict pullback of $X[U, x_U] \rightarrow (X, x)$ along any weakly pointed functor always exists.*

Just as we can have pointed and unpointed functors, we can have pointed anafunctors. The notion of strictly pointed anafunctor does not make much sense, so we only consider the general case.

DEFINITION 3.14. A *pointed anafunctor* from the pointed groupoid (X, x) to the pointed groupoid (Y, y) is a span

$$(X, x) \leftarrow X[U, x_U] \xrightarrow{(f, \alpha)} (Y, y)$$

and will be denoted $(U, x_U; f, \alpha): (X, x) \dashrightarrow (Y, y)$.

There is a composition of pointed anafunctors, which is just composition of spans using the strict pullback:

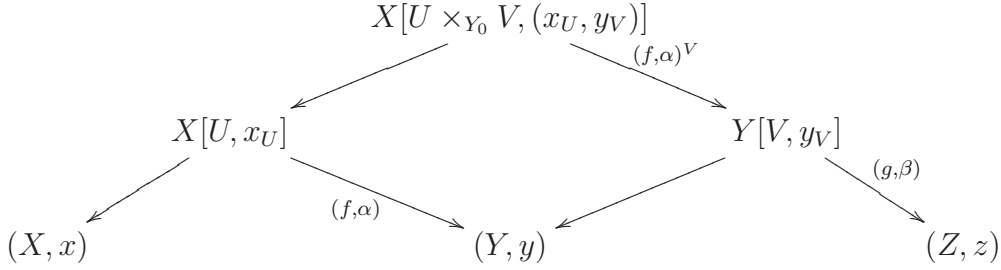

The strict pullback always exists by lemma 3.13, and the composite span is clearly pointed.

We also have pointed transformations between pointed anafunctors.

DEFINITION 3.15. A *pointed transformation* $a: (U, x_U; f, \alpha) \rightarrow (V, x_V; g, \beta)$ of pointed anafunctors is given by a diagram

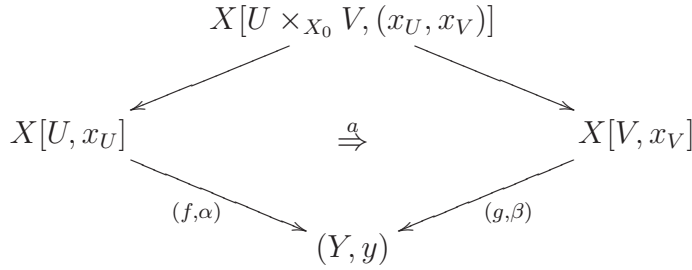

of pointed groupoids and functors

We define the vertical composition of pointed transformations as in chapter 1, using the diagram

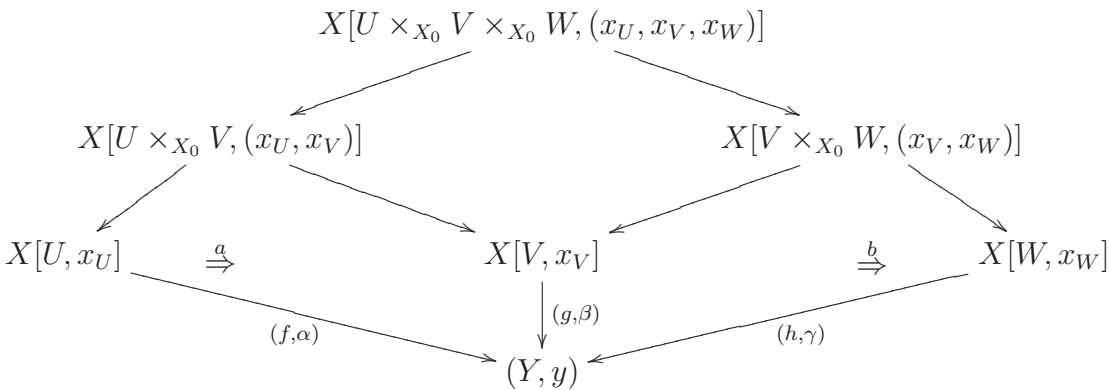

to define a natural transformation $\tilde{b}a$ between the two composite functors

$$X[U \times_{X_0} V \times_{X_0} W, (x_U, x_V, x_W)] \longrightarrow (Y, y)$$

which descends to a transformation $ba: (f, \alpha) \rightarrow (g, \beta)$.

PROPOSITION 3.16. *The vertical composition of transformations of unpointed anafunctors is again pointed.*

Proof. Firstly, the cover (5) is pointed,

$$(U \times_{X_0} V \times_{X_0} W, (x_U, x_V, x_W)) \rightarrow (U \times_{X_0} W, (x_U, x_W)).$$

If we consider the component of $\tilde{b}a$ at (x_U, x_V, x_W) , it is

$$\begin{aligned} \tilde{b}a_{(x_U, x_V, x_W)} &= b_{(x_V, x_W)} \circ a_{(x_U, x_V)} \\ &= \gamma \circ \beta^{-1} \circ \beta \circ \alpha^{-1} \\ &= \gamma \circ \alpha^{-1}. \end{aligned}$$

Thus there is a pointed map

$$(U \times_{X_0} V \times_{X_0} W, (x_U, x_V, x_W)) \rightarrow (Y_1, \gamma \circ \alpha^{-1})$$

and so we can apply remark 3.3 to get the component map of ba , which is now a pointed transformation. \square

All the arguments from chapter 1 and [Bar06] now carry through.

THEOREM 3.17. *Given a subcanonical singleton pretopology J on \mathbf{Top} , there is a bicategory $\mathbf{Ana}_*(J)$ of pointed topological groupoids, pointed anafunctors and pointed transformations.*

There is a canonical strict 2-functor $TG_* \rightarrow \mathbf{Ana}_*(J)$, which is the identity on objects and sends weakly pointed functors $(f, \alpha): (X, x) \rightarrow (Y, y)$ to anafunctors

$$(X, x) \xleftarrow{=} (X, x) \xrightarrow{(f, \alpha)} (Y, y)$$

and pointed transformations $a: (f, \alpha) \Rightarrow (g, \beta): (X, x) \rightarrow (Y, y)$ to transformations given by

$$\begin{array}{ccc} & (X, x) & \\ \begin{array}{c} \swarrow \\ = \end{array} & & \begin{array}{c} \searrow \\ = \end{array} \\ (X, x) & \xRightarrow{\alpha} & (X, x) \\ \begin{array}{c} \searrow \\ (f, \alpha) \end{array} & & \begin{array}{c} \swarrow \\ (g, \beta) \end{array} \\ & (Y, y) & \end{array}$$

The following proposition tells us, in conjunction with theorem 1.83, that pointed weak equivalences are sent to equivalences in $\mathbf{Ana}_*(J)$.

PROPOSITION 3.18. *A pointed J -equivalence $(f, \alpha): (X, x) \rightarrow (Y, y)$ admits a pseudosection in $\mathbf{Ana}_*(J)$.*

Proof. By lemma 1.69, there is an *unpointed* anafunctor $(U, f'): Y \dashrightarrow X$, where $U \rightarrow X_0$ is some J -cover, and a natural transformation

$$\begin{array}{ccc} & X & \\ f' \nearrow & \Downarrow a & \searrow f \\ Y[U] & \longrightarrow & Y \end{array}$$

Let $y_U \in U$ be some lift of y , and let $\psi = a_{y_U}: f f'(y_U) \rightarrow y$, the component of a at y_U . Since f is fully faithful, the arrow

$$f(x) \xrightarrow{\alpha^{-1}} y \xrightarrow{\psi^{-1}} f f'(y_U)$$

in Y lifts to X , call it $\alpha': x \rightarrow f'(y_U)$. Then (f', α') is a pointed functor, and it is easy to check that this choice makes a a pointed transformation. Following the same reasoning as in lemma 1.69, this anafunctor is a pseudosection of the pointed anafunctor associated to (f, α) . \square

We would like to use theorem 1.83 about 2-functors sending only some 1-cells to equivalences. To do this, we need to show that the functors $Y[U, y_U] \rightarrow (Y, y)$ induced from pointed covers of Y_0 are sent to equivalences in $\mathbf{Ana}_*(J)$, and that the functor (f', α') from the previous proposition is a J -equivalence.

LEMMA 3.19. *The pointed anafunctor*

$$(Y, y) \leftarrow Y[U, y_U] \overset{=} \rightrightarrows Y[U, y_U]$$

is pseudoinverse to the anafunctor

$$Y[U, y_U] \overset{=} \leftarrow Y[U, y_U] \rightarrow (Y, y)$$

Proof. The composite anafunctors are

$$(18) \quad (Y, y) \leftarrow Y[U, y_U] \rightarrow (Y, y)$$

and

$$(19) \quad Y[U, y_U] \leftarrow Y[U][U \times_{Y_0} U, (y_U, y_U)] \rightarrow Y[U, y_U].$$

The anafunctor (18) is isomorphic to the identity anafunctor on Y by the transformation

$$\begin{array}{ccc} & Y[U, y_U] & \\ \swarrow & & \searrow = \\ (Y, y) & = & Y[U, y_U] \\ \searrow = & & \swarrow \\ & (Y, y) & \end{array}$$

The anafunctor (19) is exactly the same form as the first, and is likewise isomorphic to the identity anafunctor on $Y[U, y_U]$. \square

LEMMA 3.20. *Let $(f, \alpha): (X, x) \rightarrow (Y, y)$ be a pointed J -equivalence, and (f', α') the weakly pointed functor constructed in proposition 3.18. Then (f', α') is a pointed J -equivalence.*

Proof. Since f is fully faithful, $X_1 \simeq X_0^2 \times_{Y_0^2} Y_1$. Let $a : U \rightarrow Y_1$ be the component map of the transformation from 3.18. Then the arrow component of f' is

$$\begin{aligned} U^2 \times_{Y_0^2} Y_1 &\rightarrow X_0^2 \times_{Y_0^2} Y_1 \\ (u, v, j) &\mapsto (f'(u), f'(v), a_v \circ j \circ a_u^{-1}) \end{aligned}$$

and the following diagram is a pullback

$$\begin{array}{ccc} U^2 \times_{Y_0^2} Y_1 & \longrightarrow & X_0^2 \times_{Y_0^2} Y_1 \\ \text{pr}_1 \downarrow & & \downarrow \text{pr}_1 \\ U^2 & \longrightarrow & X_0^2 \end{array}$$

making f' fully faithful. Now we need to find a cover $V \rightarrow X_0$ and a local section

$$\begin{array}{ccc} & & V \\ & \swarrow \text{dashed} & \downarrow \\ U \times_{f', X_0} X_1 & \longrightarrow & X_0 \end{array}$$

Let V be the pullback cover

$$\begin{array}{ccc} U \times_{Y_0} X_0 & \longrightarrow & X_0 \\ \downarrow & & \downarrow f \\ U & \longrightarrow & Y_0 \end{array}$$

Then the map

$$\begin{aligned} U \times_{Y_0, f} X_0 &\rightarrow X_0^2 \times_{Y_0^2} Y_1 \\ (u, x') &\mapsto (x', f'(u), a_u) \end{aligned}$$

gives us a map $\chi: U \times_{Y_0, f} X_0 \rightarrow X_1$ using the fact f is fully faithful. This satisfies $s \circ \chi(u, x') = x'$ and $t \circ \chi(u, x') = f'(u)$. This gives us a map

$$\begin{aligned} U \times_{Y_0, f} X_0 &\rightarrow U \times_{X_0} X_1 \\ (u, x') &\mapsto (u, \chi(u, x')) \end{aligned}$$

which is the desired local section. □

As mentioned earlier, the weak pullback of pointed groupoids always exists, and is just given by choosing the ‘obvious’ basepoint for the unpointed weak pullback:

$$\begin{array}{ccc}
 (X \times_Y Y^{\mathbf{I}} \times_Y Z, (x, \alpha \circ \beta^{-1}, z)) & \longrightarrow & (Z, z) \\
 \downarrow & & \downarrow (g, \beta) \\
 (X, x) & \xrightarrow{(f, \alpha)} & (Y, y)
 \end{array}$$

LEMMA 3.21. *The weak pullback is given by the strict pullback*

$$\begin{array}{ccc}
 (X \times_Y Y^{\mathbf{I}} \times_Y Z, (x, \alpha \circ \beta^{-1}, z)) & \xrightarrow{(\text{pr}_{23}, \text{id})} & (Y^{\mathbf{I}} \times_Y Z, (\alpha \circ \beta^{-1}, z)) \\
 \downarrow (\text{pr}_1, \text{id}_x) & & \downarrow (\text{pr}_1, \eta) \\
 (X, x) & \xrightarrow{(f, \alpha)} & (Y, y) \\
 & & \downarrow (\mathbf{s}, \text{id}_y)
 \end{array}$$

where $\mathbf{s}: Y^{\mathbf{I}} \rightarrow Y$ is defined on the level of objects by sending an arrow to its source, and $\eta: \beta \rightarrow \alpha \circ \beta^{-1}$ is the following arrow in $Y^{\mathbf{I}}$ (with source at the bottom and target at the top):

$$\begin{array}{ccc}
 (g(z) \xrightarrow{\alpha \circ \beta^{-1}} f(x)) & & \\
 \beta \uparrow & & \uparrow \alpha \circ \beta^{-1} \\
 (y \xrightarrow{\beta} g(z)) & &
 \end{array}$$

LEMMA 3.22. *The weak pullback of a pointed weak equivalence is a pointed weak equivalence*

Proof. This is immediate, since the weak pullback of a J -equivalence is again a J -equivalence (using lemma 1.88). \square

The following is a result analogous to one derived in [Pro96], section 4.1 while checking the axiom 2CF4 (there called BF4).

LEMMA 3.23. *A fully faithful, weakly pointed functor $(f, \alpha): (Y, y) \rightarrow (Z, z)$ induces a fully faithful functor*

$$\mathbf{Gpd}_*((X, x), (Y, y)) \rightarrow \mathbf{Gpd}_*((X, x), (Z, z))$$

given by composition.

Proof. From Pronk’s argument in [Pro96], for each pointed transformation

$$a: (f, \alpha) \circ (g, \beta) \Rightarrow (f, \alpha) \circ (h, \gamma),$$

there is a unique *unpointed* transformation $a': g \Rightarrow h$. We will show that it is in fact pointed. First, the component of a at x is the composite arrow

$$f(g(x)) \xrightarrow{f(\beta)^{-1}} f(y) \xrightarrow{\alpha^{-1}} z \xrightarrow{\alpha} f(y) \xrightarrow{f(\gamma)} f(h(y))$$

which is simply $f(\gamma \circ \beta^{-1})$. The component map of a' is given by

$$X_0 \xrightarrow{(g,h;a)} Y_0^2 \times_{Z_0^2} Z_1 \simeq Y_1$$

so $a'_x = \gamma \circ \beta^{-1}$, which means a' is pointed. \square

THEOREM 3.24. *TG_* admits a bicategory of fractions for the class $*W_J$.*

Proof. We need to show the axioms in definition 1.79 hold. Firstly, equivalences are in $*W_J$, because pointed equivalences are unpointed equivalences, which are J -equivalences. Thus 2CF1 holds. Likewise, 2CF2 holds because it holds for the unpointed case. That 2CF3 holds is lemma 3.22. Given lemma 3.23 and proposition 3.18, the same argument for showing 2CF4 in the proof of theorem 1.89 follows. \square

Since $TG_* \rightarrow \mathbf{Ana}_*(J)$ sends J -equivalences to equivalences, there is a 2-functor $TG_*[*W_J^{-1}] \rightarrow \mathbf{Ana}_*(J)$, and as expected, it is an equivalence. The proof is a direct copy of the proof of theorem 1.92, so we will omit it.

THEOREM 3.25. *There is an equivalence of bicategories*

$$TG_*[*W_J^{-1}] \simeq \mathbf{Ana}_*(J).$$

The bicategory $\mathbf{Ana}_*(J)$ of pointed topological groupoids, pointed anafunctors and transformations will be used in the next chapter as a categorification of the category of pointed spaces. The total spaces of pointed 2-covering spaces will be objects of this bicategory.

REMARK 3.26. The methods of this section should apply verbatim to any other concrete site with pullbacks and a terminal object. By a concrete site S we mean a site such that the ‘points’ functor $S(*, -): S \rightarrow \mathbf{Set}$ is faithful and covering families have underlying set-functions that are jointly surjective (see [BH10], section 4). It is reasonable to suppose that the arguments could be completely internalised, that is, written without reference to points, and would then hold in a site with pullbacks and a terminal object. Another aspect we do not consider further here is the relation to the pointed bicategory $\text{disc}(\ast) \downarrow \mathbf{Ana}(J)$, where the basepoint in a groupoid is replaced by a *clique* ([JS91, Mak96]).

CHAPTER 4

2-covering spaces I: Basic theory

In this chapter we meet 2-covering spaces for the first time, and prove some general results about their topological structure. After providing some quick background information on covering spaces, we take a closer look at topological groupoids. In particular, the very useful notion of locally trivial groupoid dating back to Ehresmann's original article [Ehr59] can be shown to correspond to groupoids which are weakly equivalent to groupoids with a discrete space of objects. We also introduce weakly discrete groupoids¹ which will be the fibres of 2-covering spaces.

After defining 2-covering spaces we prove some elementary path-lifting properties and show the induced 2-functor on fundamental bigroupoids is locally faithful. Lastly we compare 2-covering spaces with bundle A -gerbes where A is a discrete group. The consideration of non-bundle gerbe examples is postponed until chapter 5.

1. Review of covering spaces

We first give a brief review of covering spaces to fix notation and terminology, and to record some results for reference. The reader is assumed to be generally comfortable with the concept of a covering space. An excellent account is in [Lim03], but section 1.3 of the freely available [Hat02] will be sufficient. This material can be found in almost any textbook on topology or algebraic topology. All spaces are assumed to be locally path connected.

DEFINITION 4.1. Let X be a topological space. A *covering space* of X is a map $p: \tilde{X} \rightarrow X$ such that X has an open cover $\{U_\alpha\}$, and isomorphisms ϕ_α as in the commuting diagram

$$\begin{array}{ccc}
 U_\alpha \times F_\alpha & \xrightarrow{\sim \phi_\alpha} & U_\alpha \times_X \tilde{X} \\
 & \searrow & \swarrow \\
 & U_\alpha &
 \end{array}$$

for each α , where F_α is a discrete space called a *typical fibre*.

An open cover as in the definition will be called a *trivialising cover*. Denote the restriction $\tilde{X} \times_X V$ for any subspace $V \subset X$ by \tilde{X}_V , so the fibre $p^{-1}(x)$ will be denoted \tilde{X}_x . Often the space \tilde{X} itself will be called the covering space, and the map $\tilde{X} \rightarrow X$ will be called the *covering projection*.

¹Weakly discrete Lie groupoids made an appearance in [MM05], although not under that name.

REMARK 4.2. Some of the typical fibres F_α may be the empty set – note that this is not quite standard! For example, this implies that for $\tilde{X} \rightarrow X$ a covering space, $\tilde{X} \rightarrow X \coprod Y$ is a covering space for any space Y .

If (X, x) is a pointed space, then a pointed covering space is simply a covering space of X in the usual sense with a chosen point $x_0 \in p^{-1}(x)$. This precludes the empty space as a covering space, which is otherwise allowed by definition 4.1. We shall usually just refer to a pointed covering space of (X, x) as a covering space of (X, x) , the context making it clear what is intended.

DEFINITION 4.3. The category Cov_X of covering spaces of X is just the full subcategory of \mathbf{Top}/X with objects the covering spaces. The category Cov is the full subcategory of \mathbf{Top}^2 with objects the covering projections. We have analogues for pointed covering spaces, namely $Cov_{(X,x)}$ and Cov_* .

One of the first results presented for covering spaces is unique homotopy lifting.

PROPOSITION 4.4. *Let $p: \tilde{X} \rightarrow X$ be a covering space and $f_0: Y \rightarrow \tilde{X}$ a map. If $f: Y \times I \rightarrow X$ is a homotopy such that this diagram of solid arrows commutes*

$$\begin{array}{ccc}
 Y \times \{0\} & \xrightarrow{f_0} & \tilde{X} \\
 \downarrow & \nearrow \tilde{f} & \downarrow p \\
 Y \times I & \xrightarrow{f} & X
 \end{array}$$

then there is a unique lift \tilde{f} as indicated (thus a covering space is a Hurewicz fibration).

Proof. See e.g. [Hat02], Proposition 1.30. □

Taking $Y = *$ we have the following result.

COROLLARY 4.5. *Let $\gamma: I \rightarrow X$ be a path and $x \in \tilde{X}_{\gamma(0)}$. Then there is a unique path $\tilde{\gamma}: I \rightarrow \tilde{X}$ with $\tilde{\gamma}(0) = x$ such that $p \circ \tilde{\gamma} = \gamma$.*

For a path $\gamma: I \rightarrow X$, let $\text{Lift}(\gamma)$ be the set of paths $\tilde{\gamma}: I \rightarrow \tilde{X}$ such that $p \circ \tilde{\gamma} = \gamma$. There is a map of discrete spaces $ev_0: \text{Lift}(\gamma) \rightarrow \tilde{X}_{\gamma(0)}$ evaluating a path at 0, and similarly for $ev_1: \text{Lift}(\gamma) \rightarrow \tilde{X}_{\gamma(1)}$.

PROPOSITION 4.6. *The maps ev_0 and ev_1 are bijections.*

Proof. That ev_0 is a bijection is just the previous corollary. Symmetry gives the result for ev_1 . □

COROLLARY 4.7. *For X a path-connected space, any two fibres of a covering space $\tilde{X} \rightarrow X$ are (non-canonically) isomorphic.*

As a result, we shall write F for the generic fibre of a covering space of a path-connected space.

REMARK 4.8. We shall make the assumption from now on that all homotopies between paths in a space will be relative to the endpoints. A general homotopy $I \times I \rightarrow X$ will be called a *free* homotopy between paths.

PROPOSITION 4.9. *Let $p: (\tilde{X}, x_0) \rightarrow (X, x)$ be a covering space. If $\gamma_0, \gamma_1: I \rightarrow \tilde{X}$ are paths starting at x_0 such that there is a homotopy $h: I^2 \rightarrow X$ between $p \circ \gamma_0$ and $p \circ \gamma_1$, then $\gamma_0(1) = \gamma_1(1)$ and h lifts to a homotopy between γ_0 and γ_1 .*

Proof. See [Hat02], Proposition 1.30 and the remarks following the proof there. \square

Using this result the next follows immediately.

PROPOSITION 4.10. *Given a covering space $p: (\tilde{X}, x_0) \rightarrow (X, x)$, the induced map $\pi_1(\tilde{X}, x_0) \rightarrow \pi_1(X, x)$ is injective.*

REMARK 4.11. We have, in addition, that $\pi_n(p)$ is an isomorphism for all $n > 1$. This can be shown directly, using lifting properties of covering spaces. Alternatively, it follows from the result that a covering space is a fibration, using the long exact sequence in homotopy.

From this we see there is a functor $Cov_{(X,x)} \rightarrow Sub(\pi_1(X, x))$ from the category of covering spaces of (X, x) to the full subcategory of $\mathbf{Grp}/\pi_1(X, x)$ consisting of the injective homomorphisms. When considering the existence of covering spaces of X , it is necessary to discuss local homotopical properties of X . These are expressed in terms of basic open neighbourhoods.

DEFINITION 4.12. Let n be a positive integer. A space X is called *n -well-connected* if it has a basis of $(n - 1)$ -connected open neighbourhoods N_λ such that $\pi_n(N_\lambda) \rightarrow \pi_n(X)$ is the trivial map (for any choice of basepoint).

Subsets (usually open in practice) satisfying the conditions of the definition will be called *relatively n -connected*. So the definition is unambiguous for $n = 1$, we shall let ‘0-connected’ mean path-connected. We extend the definition to $n = 0$, letting *0-well-connected* mean locally path-connected, in the (non-standard!) sense that two points in a basic open neighbourhood of X are connected by a path in X .

EXAMPLE 4.13. A locally $(n - 1)$ -connected space Y for which $\pi_n(Y, y) = 0$ for all choices of basepoint y is n -well-connected. In particular, a simply-connected space which is locally path-connected is 1-well-connected.

In texts on covering spaces, the condition that is usually stated is ‘locally path-connected and semilocally simply-connected’. This is encoded in the $n = 1$ case of definition 4.12. In [PW05] the condition ‘locally relatively 2-connected’ was used in the classification of locally constant stacks. This corresponds to the $n = 2$ case of the above definition. The economy of syllables justifies, in the author’s opinion, the new terminology. For now assume the space X is path-connected and 1-well-connected.

Denote by $Cov_{(X,x)}^{conn}$ (resp. Cov_X^{conn}) the full subcategory of $Cov_{(X,x)}$ (resp. Cov_X) consisting of the covering spaces $\tilde{X} \rightarrow X$ with \tilde{X} path-connected. The classical Galois-Poincaré correspondence is this:

THEOREM 4.14. *If X is path-connected and 1-well-connected, the functor*

$$Cov_{(X,x)}^{conn} \rightarrow Sub(\pi_1(X, x))$$

is an equivalence

The proof can be found in almost any book on algebraic topology.

REMARK 4.15. There are more sophisticated versions of this theorem, where it is possible to drop the assumptions of connectedness on the space X and the covering spaces, but we shall just refer the reader to [Bro06] for a textbook account.

In particular, a simply-connected covering space is initial in $Cov_{(X,x)}$, and is referred to as a universal covering space. This is unique up to a unique isomorphism, and so we can simply call it *the* universal covering space. If we are instead working in one of the categories Cov_X^{conn} (unpointed, path-connected covering spaces), $Cov_{(X,x)}$ or Cov_X , then a simply-connected covering space, with or without basepoint as appropriate, is weakly initial, in that there is at least one morphism from it to any other covering space.

This generalises the usual condition ‘locally path-connected and semilocally simply-connected’ that one meets when dealing with covering spaces.

EXAMPLE 4.16. A locally $(n - 1)$ -connected space Y for which $\pi_n(Y, y) = 0$ for all choices of basepoint y is n -well-connected. In particular, a simply-connected space which is locally path-connected is 1-well-connected.

EXAMPLE 4.17. CW-complexes and topological manifolds are n -well-connected for all $n > 0$.

A useful lemma for showing that a given map is a covering projection is this:

LEMMA 4.18. *If $f: X \rightarrow Y$ is a map of spaces such that there is an open cover $\coprod_{\alpha} U_{\alpha} \rightarrow Y$ with $X \times_Y U_{\alpha} \rightarrow U_{\alpha}$ a covering space for all α , then f is a covering projection.*

The proof is just a simple verification of the definition of a covering space.

DEFINITION 4.19. Let (X, x) be a connected, 1-well-connected pointed space. Then the set

$$X^{(1)} = \{\gamma: I \rightarrow X \mid \gamma(0) = x\} / (\text{homotopy rel endpoints})$$

equipped with the topology arising from the basic open neighbourhoods

$$N_{[\gamma]}(U) = \{[\eta \cdot \gamma] \in X^{(1)} \mid \eta: I \rightarrow U, \eta(0) = \gamma(1)\}, \quad U \in X \text{ relatively 1-connected}$$

and the map $ev_1: (X^{(1)}, \underline{x}) \rightarrow (X, x)$ is called the *canonical covering space* (here \underline{x} denotes the equivalence class of the constant path at x).

PROPOSITION 4.20. *The canonical covering space is a path-connected and simply-connected covering space.*

Proof. See Section 1.3 of [Hat02]. □

Since $X^{(1)}$ is simply-connected, and by construction the basic open sets are path-connected, we have the simple result that $X^{(1)}$ is 1-well-connected.

EXAMPLE 4.21. If A is a simply connected space, $A^{(1)} \simeq A$ for any choice of basepoint in A .

LEMMA 4.22. *If $f: (X, x) \rightarrow (Y, y)$ is a pointed map of spaces, there is an induced map $f^{(1)}: (X^{(1)}, \underline{x}) \rightarrow (Y^{(1)}, \underline{y})$ covering f .*

Proof. There is certainly a map of underlying pointed sets, which makes this square of pointed functions commute

$$\begin{array}{ccc} X^{(1)} & \xrightarrow{f^{(1)}} & Y^{(1)} \\ \downarrow & & \downarrow \\ X & \xrightarrow{f} & Y \end{array}$$

All we need to show is that $f^{(1)}$ is continuous. Consider the set

$$(f^{(1)})^{-1}(N_{[f \circ \gamma]}^Y(U)) = \{[\eta] \in X^{(1)} \mid [f \circ \eta] = [f \circ \gamma \cdot \varepsilon], \varepsilon: I \rightarrow U\}$$

Choose an inessential open $V \subset f^{-1}(U)$ containing $\gamma(1)$. Then

$$N_{[\gamma]}^X(V) \subset (f^{(1)})^{-1}(N_{[f \circ \gamma]}^Y(U))$$

and so $f^{(1)}$ is continuous □

This shows that the construction of the canonical covering space is functorial. If we let $\mathbf{Top}_*^{\text{conn}, 1wc}$ be the category of connected, 1-well-connected, pointed spaces

PROPOSITION 4.23. *The assignment*

$$(X, x) \mapsto ((X^{(1)}, \underline{x}) \rightarrow (X, x))$$

defines a functor

$$\mathbf{Top}_*^{\text{conn}, 1wc} \rightarrow \mathbf{Cov}_*.$$

REMARK 4.24. When we consider spaces which are not connected, we can deal one component at a time, given a basepoint for each component. In fact, there is a way to functorially define the universal covering space of an unpointed, not necessarily connected, 1-well-connected space (see [nLa09a] for a particularly categorical viewpoint). Universal here means in the category of covering spaces $\tilde{X} \rightarrow X$ that induce isomorphisms $\pi_0(\tilde{X}) \rightarrow \pi_0(X)$. This construction turns out to be isomorphic to the canonical covering space for a connected space, for any choice of basepoint.

Understandably, not having to pick a basepoint for an unpointed space is far more preferable.

In [Whi52] G.W. Whitehead constructs, for any pointed space (X, x) , a pointed Hurewicz fibration $p_n: X(n) \rightarrow X$, $n \geq 0$ such that $\pi_k(p_n)$ is an isomorphism for $k > n$ and $X(n)$ is n -connected. In modern terms this construction is the homotopy fibre of the map $X \rightarrow X_n$ for X_n ‘the’ n^{th} Postnikov stage. More concretely, let X'_n be a space obtained from X by attaching cells to kill off all homotopy groups above dimension n . Then $X(n)$ is the pullback of the fibration $P_x X'_n$ along the inclusion. There is a tower

$$\dots \rightarrow X(2) \rightarrow X(1) \rightarrow X(0) \rightarrow X$$

where $X(0)$ is (up to homotopy) the path component of x .

This construction is obviously very non-canonical, and only defined up to homotopy. Except, when $n = 1$ and X is 1-well-connected, we have the canonical covering space, which is functorial. Also, if we work in the differentiable category the canonical covering space $M^{(1)}$ of a smooth manifold M can be given the structure of a smooth manifold. This is obviously a far cry from the result obtained via killing homotopy groups.

The two constructions, the homotopy theoretic and the topological, at first glance are completely different approaches to the same problem. However, we can write the topological construction (for the well-connected case) in analogous terms to the Whitehead construction, but using topological groupoids instead of just spaces. To do this we need to consider some non-standard facts about covering spaces.

2. Locally trivial and weakly discrete groupoids

Unless specified otherwise, in this section ‘weak equivalence’ refers to an \mathcal{O} -equivalence, where \mathcal{O} is the usual pretopology of opens on **Top**. We begin with a notion due to Ehresmann [Ehr59], relating locally trivial bundles and topological groupoids.

DEFINITION 4.25. A *locally trivial groupoid* X is a groupoid such that for each object $p \in X_0$ there is an open neighbourhood $U_p \ni p$ in X_0 and a lift

$$\begin{array}{ccc} & & X_1 \\ & \nearrow \text{---} & \downarrow (s,t) \\ \{p\} \times U_p & \longrightarrow & X_0 \times X_0 \end{array}$$

as indicated.

EXAMPLE 4.26. A t-d groupoid is locally trivial.

Recall that a groupoid is *transitive* if $X_1 \xrightarrow{(s,t)} X_0 \times X_0$ is surjective.

PROPOSITION 4.27 (Ehresmann). *Let (X, x) be a pointed, transitive topological groupoid that is locally trivial and has discrete hom-spaces. Then*

$$s^{-1}(x) \xrightarrow{t} X_0$$

is a covering space with non-empty fibres. We also² have a covering space

$$(s, t): X_1 \rightarrow X_0 \times X_0.$$

It is an easy exercise to show that for a groupoid satisfying the conditions of the proposition there is a weak equivalence $\mathbf{B} \text{Aut}_X(x) \hookrightarrow X$. Since $\mathbf{B} \text{Aut}_X(x)$ is a t-d groupoid, X represents a connected 1-type.

If X is any space, we can topologise the arrows of the fundamental groupoid $\Pi_1(X)$ (see proposition 5.22). Now $\Pi_1(X)$ has discrete hom-sets if X is semilocally simply connected (see³ proposition 5.23). It is also locally trivial, and for path-connected X the canonical covering space is the source fibre of $\Pi_1(X)$.

This does still not in any way look like the Whitehead construction, but soon will, after we introduce *tangent groupoids*. These were introduced in [RS08] for 1- and 2-categories, and generalised in [Bak07] to bicategories. While the former only discusses the concept for 2-groupoids in **Set**, the [Bak07] has an internalised version of the tangent bicategory.

DEFINITION 4.28. Let X be a groupoid. The *tangent groupoid* TX is the pull-back

$$\begin{array}{ccc} TX & \longrightarrow & X^2 \\ \downarrow & & \downarrow s \\ \text{disc}(X_0) & \longrightarrow & X \end{array}$$

As such it is the internalised version of the coproduct of slice groupoids $\coprod_{X_0} x \downarrow X$. The arrow $TX \rightarrow \text{disc}(X_0)$ is an internal equivalence. The fibre $T_x X$ at $x \in X_0$ is just $x \downarrow X$ and is internally equivalent to the trivial groupoid $*$. The terminology arose from considerations of higher gauge theory [Sch07].

There is a functor $T_x X \rightarrow X$, with the following action on arrows

$$\begin{array}{ccc} & \xrightarrow{\quad} & y \\ & \curvearrowright & \downarrow \\ x & & z \\ & \curvearrowleft & \\ & \xrightarrow{\quad} & \end{array} \mapsto y \longrightarrow z ,$$

²Ehresmann actually proved more than this – given any locally trivial transitive topological groupoid X , $X_1 \rightarrow X_0 \times X_0$ is a fibre bundle, and $s^{-1}(x) \rightarrow X_0$ is a principal bundle.

³[Bli02] has a similar result, for the case when the fundamental group is given the identification topology from the compact-open topology on the based loop space.

and is easily checked to be a covering map of groupoids [Bro06]. Formally, $T_x X$ is analogous to the based path space of a pointed space.

LEMMA 4.29. *The source fibre $s^{-1}(x)$ of a pointed groupoid (X, x) is isomorphic to the strict pullback*

$$(20) \quad \begin{array}{ccc} (\text{disc}(X) \times_X T_x X, (x, \text{id}_x)) & \longrightarrow & (T_x X, \text{id}_x) \\ \downarrow & & \downarrow \\ \text{disc}(X_0, x) & \longrightarrow & (X, x) \end{array}$$

of pointed groupoids. Notice that the pullback is a space, not a groupoid.

Hence for a groupoid satisfying the conditions of proposition 4.27, the pullback (20) is a covering space. Now we can see that the canonical covering space of a 1-well-connected space X is the pullback

$$\begin{array}{ccc} X^{(1)} & \longrightarrow & T_x \Pi_1(X) \\ \downarrow & & \downarrow \\ X & \longrightarrow & \Pi_1(X) \end{array}$$

of a path fibration-like object, along the inclusion of X into a representative of its 1-type. We have not defined the topology on $\Pi_1(X)$, or any possible conditions that may need to be satisfied – this will be done shortly. Also, the sense in which $\Pi_1(X)$ is a 1-type will be clarified. The topological construction of a 1-connected cover is thus formally analogous to the homotopy construction from [Whi52]. This points the way towards constructing 2-covering spaces for a given space that satisfies a two-dimensional well-connectedness condition.

DEFINITION 4.30. A *weakly discrete groupoid* is a topological groupoid P such that there is a t-d groupoid D and an equivalence $D \leftrightarrow P$ in $\mathbf{Ana}(\mathbf{Top})$.

Since a functor $D[U] \rightarrow D$ has a pseudoinverse when D is a t-d groupoid, we can equivalently say a weakly discrete groupoid is a groupoid P such that there is a weak equivalence

$$D \rightarrow P$$

in TG , with D topologically discrete. It is immediate that the property of being weakly discrete is preserved by weak equivalence.

For any groupoid X , let X^δ denote the t-d groupoid given by taking the discrete topologies on the underlying sets of X_1 and X_0 . There is a canonical functor $X^\delta \rightarrow X$.

LEMMA 4.31. *If $f: X \rightarrow Y$ is an weak equivalence of topological groupoids, the induced map $|f|: X_0/X_1 \rightarrow Y_0/Y_1$ is a homeomorphism.*

Proof. It is obviously a bijection, we only need to show the existence of a continuous inverse. Let $U = \coprod U_\alpha \rightarrow Y_0$ be an open cover over which there are local sections σ_α of $X_0 \times_{Y_0} Y_1 \rightarrow Y_0$. Consider the composites

$$k_\alpha: U_\alpha \rightarrow X_0 \times_{Y_0} Y_1 \rightarrow X_0 \rightarrow X_0/X_1.$$

If $u \in U_\alpha \cap U_\beta$, the sections $\sigma_\alpha, \sigma_\beta$ together with the full faithfulness of f give an arrow in X between $k_\alpha(u)$ and $k_\beta(u)$. Thus the map $k: U \rightarrow X_0/X_1$ descends to give a map $k': Y_0 \rightarrow X_0/X_1$ which makes the diagram

$$\begin{array}{ccc} X_0 & \xrightarrow{\quad} & Y_0 \\ \downarrow & \searrow & \downarrow \\ X_0/X_1 & \xrightarrow{\quad} & Y_0/Y_1 \end{array}$$

commute. If there is an arrow between $y_1, y_2 \in Y_0$, $|f| \circ k'(y_1) = |f| \circ k'(y_2)$, but $|f|$ is injective, so $k'(y_1) = k'(y_2)$, and thus k' descends to a section of $|f|$. Hence $|f|$ is a homeomorphism. \square

LEMMA 4.32. *The hom-spaces $P(a, b)$ of a weakly discrete groupoid P are discrete, as is the space P_0/P_1 .*

Proof. Let $w: D \rightarrow P$ be a weak equivalence with D topologically discrete. The first point holds for hom-spaces of the form $P(w(c), w(d))$ because there is a homeomorphism

$$D_1 \simeq \coprod_{(c,d) \in D_0^2} D(c, d) \xrightarrow{\sim} D_0^2 \times_{P_0^2} P_1 \simeq \coprod_{(c,d) \in D_0^2} P(w(c), w(d))$$

If $a, b \in P_0$ are not in the image of w , there are isomorphisms $a \simeq w(c)$, $b \simeq w(d)$ which induce a homeomorphism $P(a, b) \simeq P(w(c), w(d))$. For the second point, apply the previous lemma to w . \square

The following result appears in [MM05] in the context of Lie groupoids.

COROLLARY 4.33. *A weakly discrete groupoid P is a disjoint union*

$$P = \coprod_{x \in P_0/P_1} P_x$$

where P_x is the fibre of $P \rightarrow \text{disc}(P_0/P_1)$ over x .

Thus if there is a path in P_0 between two objects, there is an arrow between them. This is also true for paths $\mathfrak{p} \rightarrow P$.

LEMMA 4.34. *If P is a weakly discrete groupoid, and $\gamma: \mathfrak{p} \rightarrow P$ is a path, $\gamma(0)$ and $\gamma(1)$ are isomorphic.*

We can nicely characterise locally trivial groupoids without explicitly referring to open covers.

LEMMA 4.35. *A groupoid X is locally trivial if and only if $X[X_0^\delta] \rightarrow X$ is a weak equivalence, if and only if $X^\delta \rightarrow X$ is \mathcal{O} -surjective.*

Proof. First note that the functor $X[X_0^\delta] \rightarrow X$ is always fully faithful, so we only need to address \mathcal{O} -surjectivity. Assume X is locally trivial. Then there is an cover consisting of open sets $U \hookrightarrow X_0$ such that there are local sections

$$\begin{array}{ccc} & s^{-1}(x) \hookrightarrow X_1 & \\ & \uparrow \sigma & \downarrow t \\ U & \longrightarrow & X_0 \end{array}$$

for a given $x \in U$ (this is just a simply reworking of definition 4.25). But notice that the pullback $X_0^\delta \times_{X_0, s} X_1$ is simply

$$\coprod_{x \in X_0} s^{-1}(x).$$

Thus the sections σ give local sections of

$$X_0^\delta \times_{X_0, s} X_1 \rightarrow X_1 \xrightarrow{t} X_0.$$

Thus $X^\delta \rightarrow X$ is essentially \mathcal{O} -surjective. The argument run in reverse shows that the other direction holds, hence the result. \square

Thus we see that locally trivial groupoids are essentially the same as **Top**-groupoids,⁴ where only the hom-sets have a non-discrete topology.

Merely asking for the existence of *some* t-d groupoid and weak equivalence may seem a little bit unsatisfactory for the purposes of characterising weakly discrete groupoids. However, it is possible to do so without reference to any additional data.

PROPOSITION 4.36. *A groupoid P is weakly discrete if and only if $P^\delta \rightarrow P$ is a weak equivalence.*

Proof. The “if” direction is immediate. For the other direction, assume P is weakly discrete. Then there is a topologically discrete groupoid D and a weak equivalence $w: D \rightarrow P$ which factors through $P^\delta \rightarrow P$. The functor $D \rightarrow P^\delta$ is an equivalence, and so has a pseudoinverse $P^\delta \rightarrow D$. This composes with w to give a weak equivalence $P^\delta \rightarrow P$. \square

PROPOSITION 4.37. *If $f: X \rightarrow Y$ is a weak equivalence, and either X or Y is locally trivial, then so is the other*

⁴in fact the same is true for locally trivial topological categories, which are defined to be those categories X where the maximal subgroupoid X^{iso} is locally trivial.

Proof. Assume Y is locally trivial. Given $x \in X_0$, there is an open neighbourhood $U \ni f(x)$ and a lift $\{f(x)\} \times U \rightarrow Y_1$. Let $V = f^{-1}(U) \in X_0$, an open neighbourhood of x . We thus have the following diagram

$$\begin{array}{ccc}
 X_1 & \xrightarrow{\quad} & Y_1 \\
 \downarrow & & \downarrow \\
 X_0 \times X_0 & \xrightarrow{\quad} & Y_0 \times Y_0 \\
 \nearrow & & \nearrow \\
 \{x\} \times V & \xrightarrow{\quad} & \{f(x)\} \times U
 \end{array}$$

Since f is a weak equivalence, it is fully faithful, so $X_1 \simeq X_0^2 \times_{Y_0^2} Y_1$. The universal property of the pullback gives us a map $\{x\} \times V \rightarrow X_1$ as needed. Thus X is locally trivial.

Now assume X is locally trivial. Since f is a weak equivalence, there is an anafunctor pseudosection $Y \leftarrow Y[U] \xrightarrow{\bar{f}} X$ with \bar{f} a weak equivalence. Apply the first part of the proof to see that $Y[U]$ is locally trivial. Thus we only need to show that given a weak equivalence of the form $Y[U] \rightarrow Y$ with $Y[U]$ locally trivial, Y is locally trivial.

Since $Y[U]$ is locally trivial, let $y \in Y_0$ be considered as an object y_U of $Y[U]$. There is an open neighbourhood $V \subset U$ (that is an open of Y_0 that is a subset of some $U_\alpha \subset U$) and a lift $\{y_U\} \times V \rightarrow Y[U]_1 = U^2 \times_{Y_0} Y_1$. Composition with projection on the second factor gives us the required lift for Y , and so Y is locally trivial. \square

Since t-d groupoids are locally trivial, the following corollary follows immediately.

COROLLARY 4.38. *A weakly discrete groupoid is locally trivial.*

REMARK 4.39. Since the property of local triviality of topological groupoids is preserved under weak equivalence, it can be seen as a property of the underlying topological stack.

We can formulate a characterisation in the other direction also, giving us this result.

PROPOSITION 4.40. *For a groupoid X the following are equivalent:*

- (1) X is weakly discrete,
- (2) X is locally trivial and the hom-spaces $X(x, y)$ are discrete,
- (3) $(s, t): X_1 \rightarrow X_0 \times X_0$ is a covering space where the image of (s, t) is open.

Proof. The implication (2) \Rightarrow (1) follows from corollary 4.38 and lemma 4.32. (1) \Rightarrow (2) uses lemma 4.35, whereupon $X[X_0^\delta] \rightarrow X$ is a weak equivalence, but then $X[X_0^\delta]$ is a t-d groupoid, as the space of arrows is $\coprod_{x, y \in X_0} X(x, y)$ and hence discrete. (2) \Rightarrow (3) follows from the result of Ehresmann mentioned in the footnote to proposition 4.27. To see that (3) \Rightarrow (2), by definition the hom-spaces are discrete,

and since $X_1 \rightarrow X_0 \times X_0$ is a covering space, there is a basic open set $U \times U'$ of $X \times X$ containing (x, x) , contained in the image of (s, t) , over which there is a section of (s, t) . Precompose this section with the inclusion $\{x\} \times U' \hookrightarrow U \times U'$ to get the local section required for the definition of local triviality. \square

LEMMA 4.41. *If Y is a locally trivial groupoid and $f: X \rightarrow Y$ an essentially surjective functor, in the sense that for all $y \in Y_0$ there is a pair $(x, \alpha: f(x) \rightarrow y) \in X_0 \times_{Y_0} Y_1$, then f is essentially \mathcal{O} -surjective.*

Proof. Since Y is locally trivial, for all $y \in Y_0$ there is an open neighbourhood U and a section $\sigma_1: U \rightarrow t^{-1}(y) \subset Y_1$. Define a map $\sigma_2: U \rightarrow t^{-1}(f(x))$ by $\sigma_2(y') = \alpha \circ \sigma(y')$. This is continuous, and defines a local section of $X_0 \times_{Y_0} Y_1 \xrightarrow{\text{topr}_2} Y_0$. Hence f is essentially \mathcal{O} -surjective. \square

We can repackage the usual criterion for a space to have a 1-connected covering space as follows. The phrase ‘path-connected’ in parentheses means that it isn’t really necessary, as long as one is willing to work path-component by path-component. The resulting universal covering space is universal among those that induce isomorphisms on π_0 .

PROPOSITION 4.42. *A (path-connected) space X has a universal covering space if and only if its fundamental groupoid $\Pi_1(X)$ can be topologised as a weakly discrete groupoid such that $\Pi_1(X)_0$ is homeomorphic to X .*

The proof of this is merely writing down the definition of universal covering space as the source fibre of the fundamental groupoid and correlating the definition of universal covering space with the definition of weakly discrete, via proposition 4.36.

REMARK 4.43. It is *not* necessarily true that simply giving $\Pi_1(X)_1$ the quotient topology inherited from X^I with the compact-open topology makes $\Pi_1(X)$ a topological groupoid, as the multiplication map is not necessarily continuous. This was remarked in [Bra09, Fab09], where attention was only paid to the fundamental group (which is of course a subgroupoid of Π_1). The fundamental group with this topology is always a *quasi-topological* group, meaning the inversion $(-)^{-1}: \pi_1 \rightarrow \pi_1$, and the left and right multiplication maps $L_g, R_g: \pi_1 \rightarrow \pi_1$ are homeomorphisms, so it would be interesting to consider a theory of quasi-topological groupoids. Note however that if a space is 1-well-connected, its fundamental group considered with this topology is discrete, and if the fundamental group is discrete, the space is semi-locally 1-connected.

PROPOSITION 4.44. *Given a weak homotopy equivalence $X \rightarrow Y$ of (path-connected) spaces where Y has a universal covering space, then X has a universal covering space.*

Proof. Since $X \rightarrow Y$ is a weak homotopy equivalence, it induces isomorphisms on π_0 and π_1 , meaning the induced functor $\Pi_1(X) \rightarrow \Pi_1(Y)$ between t-d groupoids

is an equivalence. The groupoid $\Pi_1(Y)$ can be topologised so as to be weakly discrete (hence locally trivial), so we define the *space* $\Pi_1(X)_1$ as $X^2 \times_{Y^2} \Pi_1(Y)_1$ giving us full faithfulness. The essential \mathcal{O} -surjectivity follows from lemma 4.41. \square

This proposition (or more precisely, its corollary below) shows that the property of having a universal covering space is connected to the homotopy type of a space, and not the space itself. The only other proof of this fact that I am aware of uses the long exact sequence in homotopy associated to a fibration, which is a bit of a detour, needing also to use the fact a covering space is a fibration.

COROLLARY 4.45. *If $X \rightarrow Y$ is a homotopy equivalence, X has a universal covering space if and only if Y does.*

3. 2-covering spaces

The fibres of a covering space are discrete spaces, that is, spaces in the essential image of the functor $\mathbf{Set} \rightarrow \mathbf{Top}$. The fibres of 2-covering spaces are topological groupoids in the essential image of the functor $\mathbf{Gpd} \rightarrow \mathbf{Ana}(\mathbf{Top})$, that is, weakly discrete groupoids.

REMARK 4.46. We shall drop the notation ‘disc’ for spaces in TG to save space. It will be made clear which are spaces and which are groupoids.

The following definition is at the core of this thesis.

DEFINITION 4.47. A 2-covering space $\pi : Z \rightarrow X$ of a space X is a groupoid Z such that there is a cover $U = \coprod_{\alpha} U_{\alpha} \rightarrow X$, an equivalence pair $(\phi_{\alpha}, \bar{\phi}_{\alpha})$ and a diagram

$$\begin{array}{ccc} U_{\alpha} \times D_{\alpha} & \begin{array}{c} \xrightarrow{\phi_{\alpha}} \\ \xleftarrow{\bar{\phi}_{\alpha}} \end{array} & Z \times_X U_{\alpha} \\ & \searrow & \swarrow \\ & U_{\alpha} & \end{array}$$

in $\mathbf{Ana}(\mathbf{Top})$ for each α , where D_{α} is topologically discrete. Such a cover of the base space X is called *trivialising*.

Since Z is a groupoid over a discrete groupoid i.e. a topological space, the hom-space $Z(z, z')$ is empty unless z and z' are in the same fibre of $Z_0 \rightarrow X$. This property is referred to as the arrows of Z being *vertical*. Here are some more immediate properties of 2-covering spaces.

PROPOSITION 4.48. *For any 2-covering space $\pi : Z \rightarrow X$ we have:*

- (1) *The functor $Z \rightarrow X$ factors through the space Z_0/Z_1 , and if the fibres of π are transitive, $Z_0/Z_1 \simeq X$.*
- (2) *The fibres Z_x of π are weakly discrete. This implies that the hom-spaces $Z(z, z')$ are discrete.*
- (3) *For any vertical path $\gamma : I \rightarrow Z_0$, there is an arrow between $\gamma(0)$ and $\gamma(1)$.*

Proof.

- (1) This is the universal property of the coequaliser $Z_1 \rightrightarrows Z_0 \rightarrow Z_0/Z_1$.
- (2) The equivalence ϕ_α restricts to an equivalence $\{x\} \times D_\alpha \xrightarrow{\sim} Z_x$, and as D_α is topologically discrete, this gives a weak equivalence $D_\alpha \rightarrow Z_x$ and so Z_x is weakly discrete.
- (3) This is just lemma 4.34. □

EXAMPLE 4.49. Any 2-covering space $Z \rightarrow X$ that is equivalent to $\text{pr}_1: X \times D \rightarrow X$ is called *trivialisable*. If P is a weakly discrete groupoid and X' is a topological groupoid weakly equivalent to the space X , then $X' \times P \rightarrow X$ is a trivialisable 2-covering space. Note that not all trivial 2-covering spaces are of this form, though.

EXAMPLE 4.50. Let $S^3 \rightarrow S^2$ be the standard Hopf bundle. Form the groupoid $S^3 \rtimes \mathbb{R}$, which is the action groupoid of \mathbb{R} on S^3 via the homomorphism $\mathbb{R} \rightarrow S^1$. This is a groupoid over S^2 , and if $U \subset S^2$ is an open set over which the Hopf bundle trivialises, the following diagram is a pullback

$$\begin{array}{ccc} U \times (S^1 \rtimes \mathbb{R}) & \longrightarrow & S^3 \rtimes \mathbb{R} \\ \downarrow & & \downarrow \\ U & \longrightarrow & S^2 \end{array}$$

There is a weak equivalence $\mathbf{B}\mathbb{Z} \rightarrow S^1 \rtimes \mathbb{R}$ where \mathbb{Z} is the automorphism group of $1 \in S^1$. Any choice of equivalences

$$U \times (S^1 \rtimes \mathbb{R}) \begin{array}{c} \xrightarrow{\sim} \\ \longleftarrow \\ \longleftarrow \\ \xrightarrow{\sim} \end{array} U \times \mathbf{B}\mathbb{Z}$$

for each trivialising open $U \subset S^2$ give $S^3 \rtimes \mathbb{R} \rightarrow S^2$ the structure of a 2-covering space.

This analysis can be carried out verbatim for the S^1 bundles over S^2 with total space the lens spaces $L(1, p) = S^3/(\mathbb{Z}/p)$, giving us a family of 2-covering spaces of S^2 , indexed by positive integers (the case $p = 1$ corresponding to $S^3 \rightarrow S^2$). See proposition 4.89 for a generalisation of this example for an arbitrary discrete abelian group replacing \mathbb{Z} .

REMARK 4.51. One may wonder whether $S^3 \rtimes \mathbb{R} \rightarrow S^2$ is a trivialisable 2-covering space. In fact there is no equivalence $S^3 \rtimes \mathbb{R} \xrightarrow{\sim} S^2 \times \mathbf{B}\mathbb{Z}$, so it certainly isn't trivialisable. We can see this as follows: if there was such a weak equivalence, it would be mapped by Π_2 to an equivalence of bigroupoids (proposition 2.127), in particular, the underlying fundamental groupoids would be equivalent. Since Π_1 preserves products and S^2 is simply connected, $\Pi_1(S^2 \times \mathbf{B}\mathbb{Z}) \simeq \Pi_1(\mathbf{B}\mathbb{Z}) \simeq \mathbf{B}\mathbb{Z}$, as $\mathbf{B}\mathbb{Z}$ is topologically discrete (proposition 2.117). But from lemma 2.110 we see that $S^3 \rtimes \mathbb{R}$ is 1-connected, and so cannot be equivalent to $S^2 \times \mathbf{B}\mathbb{Z}$. Thus we can be assured that non-trivial 2-covering spaces exist.

Even though weakly equivalent topological groupoids can have widely differing spaces of objects and arrows, the property of being a 2-covering space is invariant under weak equivalence. If $Z \rightarrow X$ is a 2-covering space, any equivalence $Z \dashrightarrow Z'$ over X restricts to an equivalence over a trivialising cover, and hence Z' is locally trivial. Thus we have the easy result

PROPOSITION 4.52. *If $Z \rightarrow X$ is a 2-covering space, any groupoid over X that is weakly equivalent to Z is also a 2-covering space. In particular, given a cover $U \rightarrow Z_0$, $Z[U] \rightarrow X$ is a 2-covering space.*

REMARK 4.53. The thesis [Lew07], while mostly taking a simplicial point of view, also attempts to define objects which are intended to be a topological counterpart to stacks on a space. These are called *2-étale spaces*, which are defined as a specific sort of ‘2-bundle’, but not the sort of 2-bundle as defined in [Bar06]. However, the ‘2-bundles’ defined in section 8.2.1 of [Lew07] are trivial. To quote from [Lew07], page 104:

A *2-bundle* on X is a groupoid, E , in \mathbf{Top}/X in which all open sets $U \subseteq E_0$ are closed under isomorphism, i.e., if $u \in U$ $u \simeq v$ then v must also be in U .

This implies that E is a transitive groupoid, as E_0 is an open subset of itself. As E is equipped with a map to the space X , we know that it is mapped to a single point, as $E \rightarrow X$ factors through $E_0/E_1 = *$. The definition of 2-étale space in *loc. cit.*, divorced from the condition of being a ‘2-bundle’, looks more promising, though. We do not consider this further, beyond inviting the reader to compare the definition of a 2-étale space (minus the ‘2-bundle’ condition) with definitions 5.45 and 5.46 in this thesis.

LEMMA 4.54. *If $Z \rightarrow X$ is a 2-covering space, the map $Z_0 \rightarrow X$ admits local sections.*

Proof. Let x be any point in X , and $U \subset X$ be a neighbourhood of x over which Z trivialises. Then we have an anafunctor

$$U \times D \leftarrow (U \times D)[W] \xrightarrow{\phi} Z_U$$

over U , $W = \coprod_{\beta} W_{\beta} \rightarrow U \times D_0$ an open cover. Choose $d \in D_0$ and W_{β} such that $(x, d) \in W_{\beta}$. Restrict the functor ϕ to the discrete subgroupoid $W_{\beta} \hookrightarrow U \times B[W]$, which gives a function $W_{\beta} \rightarrow Z_0$. The composition of this function with $Z_0 \rightarrow U$ is just $W_{\beta} \hookrightarrow U$. We can consider W_{β} as an open neighbourhood of x in X , and so we have a local section of Z_0 . \square

REMARK 4.55. If we had used any other pretopology J to localise TG at the J -equivalences, as long as $\mathbf{II}\mathcal{O} \subset J$ (but not necessarily cofinal in J), we would have the result that $Z_0 \rightarrow X$ is a J -epi.

Recall from proposition 4.48 that the functor $\pi: Z \rightarrow X$ factors as

$$\begin{array}{ccc} Z & & \\ \pi \downarrow & \searrow & \\ & & Z_0/Z_1 \\ & \swarrow & \\ & & X \end{array}$$

and since the fibres of π are weakly discrete, the orbit spaces of the fibres are discrete (equivalently, the fibres of $Z_0/Z_1 \rightarrow X$ are discrete). In fact more is true:

PROPOSITION 4.56. *Let $Z \rightarrow X$ be a 2-covering space. The quotient space Z_0/Z_1 is a covering space of X via the canonical map $Z_0/Z_1 \rightarrow X$.*

Proof. Because all the arrows of Z are vertical, $(Z_U)_0/(Z_U)_1 \simeq (Z_0/Z_1)_U$ for a trivialising open set $U \subset X$. The former space, by lemma 4.31, is connected by a span of homeomorphisms to the orbit space of $U \times D$. This is just $U \times D_0/D_1$, and so $Z_0/Z_1 \rightarrow X$ is locally trivial with discrete fibre D_0/D_1 . \square

PROPOSITION 4.57. *Let $Z \rightarrow X$ be a 2-covering space. Then the canonical functor $q: Z \rightarrow Z_0/Z_1$ is a 2-covering space with transitive fibres.*

Proof. Because q is a functor over X , it induces a functor $q_U: Z_U \rightarrow (Z_0/Z_1)_U \simeq U \times D_0/D_1$ over a trivialising open set $U \subset X$. We know there is an equivalence $U \times D \dashrightarrow Z_U$, and composing this with $Z_U \rightarrow U \times D_0/D_1$ and passing to the canonical functor $U \times D \rightarrow U \times D_0/D_1$ (as opposed to anafunctor) recovers the quotient map $D \rightarrow D_0/D_1$. Let D_d denote the full subgroupoid of D consisting of all objects isomorphic to d . The pullback of the equivalence

$$\begin{array}{ccc} U \times D & \dashrightarrow & Z_U \\ & \searrow & \swarrow \\ & & U \times D_0/D_1 \end{array}$$

along the inclusion $U \times \{[d]\} \hookrightarrow U \times D_0/D_1$, namely

$$\begin{array}{ccccc} U \times D_d & \xrightarrow{\quad} & U \times D & & \\ \downarrow & \dashrightarrow & \downarrow & \dashrightarrow & \\ & & Z_{U \times \{[d]\}} & \xrightarrow{\quad} & Z_U \\ \downarrow & \swarrow & \downarrow & \swarrow & \\ U \times \{[d]\} & \xrightarrow{\quad} & U \times D_0/D_1 & & \end{array}$$

is again an equivalence. Since Z_0/Z_1 can be covered by open sets of the form $U \times \{[d]\}$, and D_d is a transitive groupoid for all d , $Z \rightarrow Z_0/Z_1$ is locally trivial with

transitive fibre. □

Notice that the map $(s, t): Z_1 \rightarrow Z_0 \times_X Z_0$ factors through the fibre product $Z_0 \times_X Z_0$ because all of the arrows of Z are vertical.

PROPOSITION 4.58. *For a 2-covering space $Z \rightarrow X$, the image of $(s, t): Z_1 \rightarrow Z_0 \times_X Z_0$ is both closed and open.*

Proof. First we shall show $\text{im}(s, t) \subset Z_0 \times_X Z_0$ is both open and closed. Since we will work locally, we can assume that Z is trivialisable, $(W, \phi): Z \rightarrow X \times D$. This gives us a diagram

$$\begin{array}{ccccccc}
 Z_1 & \longleftarrow & Z[W]_1 & \xrightarrow{\phi_1} & X \times D_1 & \xrightarrow{\text{pr}_2} & D_1 \\
 \downarrow & & \downarrow & & \downarrow & & \downarrow \\
 Z_0 \times_X Z_0 & \longleftarrow & W \times_X W & \xrightarrow{\phi_0^2} & X \times D_0^2 & \xrightarrow{\text{pr}_2} & D_0^2
 \end{array}$$

where $W \times_X W = \coprod W_{\alpha\beta}$ is the open cover with $W_{\alpha\beta} = (W_\alpha \times W_\beta) \cap Z_0 \times_X Z_0$. For $a \in Z_1$ with $(s(a), t(a)) = (z, w) \in Z_0 \times_X Z_0$, let $U \subset W_{\alpha\beta}$ be a connected open subset with $(z, w) \in U$. Denote by (z_U, w_U) the point $(z, w) \in Z_0 \times_X Z_0$ considered as a point in U . There is then a canonical arrow $a_W \in Z[W]_1$ corresponding to a (recall $Z[W] \rightarrow Z$ is by definition fully faithful). Since U is connected, its image $\text{pr}_2 \circ \phi_0^2(U)$ is a single point $(d_0, d_1) \in D_0^2$. Let $a_D = \phi_1(a_W)$, There is clearly a lift as shown

$$\begin{array}{ccc}
 & & X \times D_1 \\
 & \nearrow \lambda & \downarrow \\
 U & \xrightarrow{\text{pr}_2 \circ \phi_0^2} & X \times D_0^2
 \end{array}$$

where $\lambda(p) = (\pi(p), a_D)$. Since ϕ is fully faithful, $Z[W]_1$ is a pullback of $X \times D_1$, so there is a unique map $U \xrightarrow{\lambda'} Z[W]$ which is a local section of $Z[W] \rightarrow W \times_X W$. This gives a local section $U \rightarrow Z_1$ of $(s, t): Z_1 \rightarrow Z_0 \times_X Z_0$, through the point $a \in Z_1$. Thus the image of (s, t) is open.

Likewise, if $(z', w') \in Z_0 \times_X Z_0$ such that there is no arrow in Z between z' and w' , and if the complement $\text{im}(s, t)^c$ of $\text{im}(s, t)$ was *not* open, we would be able to find a connected open set containing (z', w') as above and a local section to Z_1 , implying $(z', w') \in \text{im}(s, t)$, an obvious contradiction. Hence $\text{im}(s, t)^c$ is open, and so $\text{im}(s, t)$ is closed. □

PROPOSITION 4.59. *Let $\pi: Z \rightarrow X$ be a 2-covering space. Then $(s, t): Z_1 \rightarrow Z_0 \times_X Z_0$ is a covering space.*

Proof. Let $(W_\alpha, \phi_\alpha): Z_{U_\alpha} \twoheadrightarrow U_\alpha \times D_\alpha$ be a system of local trivialisations of Z . The subspaces $(Z_{U_\alpha})_0 \times_X (Z_{U_\alpha})_0$ form an open cover of $Z_0 \times_X Z_0$. Notice that there is an isomorphism

$$Z_{U_\alpha}[W_\alpha]_1 = (Z_{U_\alpha})_1 \times_{(Z_{U_\alpha})_0^2} W_\alpha^2 \simeq (Z_{U_\alpha})_1 \times_{(Z_{U_\alpha})_0 \times_X (Z_{U_\alpha})_0} W_\alpha \times_X W_\alpha,$$

and so the anafunctor (W_α, ϕ_α) determines a diagram

$$\begin{array}{ccccc} (Z_{U_\alpha})_1 & \longleftarrow & Z_{U_\alpha}[W_\alpha]_1 & \longrightarrow & X \times D_1 \\ \downarrow & & \downarrow & & \downarrow \\ (Z_{U_\alpha})_0 \times_X (Z_{U_\alpha})_0 & \longleftarrow & W_\alpha \times_X W_\alpha & \longrightarrow & X \times D_0^2 \end{array}$$

where both squares are pullbacks. If we consider a connected component $X \times \{(d_0, d_1)\}$ of $X \times D_0^2$, then $X \times D(d_0, d_1) \rightarrow X \times \{(d_0, d_1)\}$ is a covering space, hence $X \times D_1 \rightarrow X \times D_0^2$ is a covering space (with some empty fibres, which we have allowed). Then $Z_{U_\alpha}[W_\alpha]_1 \rightarrow W_\alpha \times_X W_\alpha$ is a covering space. Using lemma 4.18 for the cover $W_\alpha \times_X W_\alpha \rightarrow (Z_{U_\alpha})_0 \times_X (Z_{U_\alpha})_0$, we see that $(Z_{U_\alpha})_1 \rightarrow (Z_{U_\alpha})_0 \times_X (Z_{U_\alpha})_0$ is a covering space. This is true for all α , and so applying lemma 4.18 again to the cover $\coprod_\alpha (Z_{U_\alpha})_0 \times_X (Z_{U_\alpha})_0 \rightarrow Z_0 \times_X Z_0$, we get the result that $Z_1 \rightarrow Z_0 \times_X Z_0$ is a covering space. \square

We now give a couple of simple corollaries.

COROLLARY 4.60. *For a 2-covering space $Z \rightarrow X$, the map $Z_1 \rightarrow Z_0 \times_X Z_0$ admits local sections over its image, through every point in Z_1 . If the fibres of Z are transitive, we have local sections around any point in $Z_0 \times_X Z_0$.*

COROLLARY 4.61. *If $Z \rightarrow X$ is a 2-covering space and $Z_0 \times_X Z_0$ is path-connected, $Z(z, z') \simeq Z(w, w')$ as sets for all $(z, z'), (w, w') \in Z_0 \times_X Z_0$. In particular, all of the sets $Z(w, w')$ are (non-canonically) isomorphic to the underlying set of the group $Z(z, z)$ for any given $z \in Z_0$.*

Proof. The fibre of $Z_1 \rightarrow Z_0 \times_X Z_0$ at (z, z') is $Z(z, z')$, and by path-connectedness of the base, all fibres are isomorphic. \square

If we consider just one fibre Z_x of $Z \rightarrow X$, the fibred product $Z_x \times_X Z_x$ is just the cartesian product $Z_x \times Z_x$. For a point $z \in Z_x$, a local section $U \rightarrow Z_1$ of $Z_1 \rightarrow Z_0 \times_X Z_0$ where $U \ni (z, z)$, guaranteed by corollary 4.60, restricts to a section $\{z\} \times U \rightarrow (Z_x)_1$. Thus we have another proof of the following result.

PROPOSITION 4.62. *For a 2-covering space $Z \rightarrow X$ the fibres are locally trivial groupoids.*

The reason this is a second proof is that the fibres are all weakly discrete groupoids, which are locally trivial by corollary 4.38. However, the reasoning behind proposition 4.62 would also apply for more general 2-bundles than 2-covering spaces (say where the fibres are not assumed to be weakly discrete).

4. Lifting of paths and surfaces

We have analogous results to the case of covering spaces, but this time we have to allow uniqueness up to isomorphism.

PROPOSITION 4.63. *Let $(Z, z) \rightarrow (X, x)$ be a 2-covering space and $\gamma \in P_x X$. Then there is a path $\tilde{\gamma}: \mathfrak{p} \rightarrow Z$ such that $\tilde{\gamma}(0) \simeq z$. That is, the following diagram exists*

$$\begin{array}{ccc}
 \{0\} & \xrightarrow{z} & Z \\
 \downarrow & \searrow & \parallel \\
 & & \mathfrak{p} \\
 \downarrow & \swarrow & \nearrow \tilde{\gamma} \\
 I & \xrightarrow{\gamma} & X
 \end{array}$$

Such a path $\tilde{\gamma}$ is said to lift γ .

Proof. First, let \mathfrak{p} be a partition groupoid, given by $\{t_1, \dots, t_n\}$ such that $\gamma[\mathfrak{p}]$ factors through $\check{C}(U)$ for $U = \coprod_{i=1}^{n+1} U_i \rightarrow X$ a finite collection of opens from a trivialising cover. Let us restrict attention to a segment $[t_i^+, t_{i+1}^-] \rightarrow U_i$. Since Z_{U_i} is trivialisable, we have a diagram

$$\begin{array}{ccccc}
 * & \xrightarrow{z_i} & Z_{U_i} & \longleftarrow & Z_{U_i}[W] & \xrightarrow{\phi_i} & U_i \times D \\
 \downarrow & & \searrow & & \swarrow & & \nearrow \\
 [t_i^+, t_{i+1}^-] & \xrightarrow{\gamma_i} & U_i & & & &
 \end{array}$$

in which the indicated lift obviously exists. Call this lift γ'_i , which we choose such that the image of t_i^+ is $(\gamma_i(t_i^+), \phi_i(\bar{z}_i))$ where $\bar{z}_i \in W$ is a lift of z_i . Then there is a pseudoinverse $(W', \bar{\phi}_i): U_i \times D \dashrightarrow Z_{U_i}$, and passing to a partition $\mathfrak{q}_i \rightarrow [t_i^+, t_{i+1}^-]$, the function γ'_i lifts to a functor γ''_i to $(U_i \times D)[W']$ and hence to Z_{U_i} . Because $(W', \bar{\phi}_i)$ is pseudo inverse to (W, ϕ_i) , there is an arrow $a_i: z_i \rightarrow \gamma''(t_i^+) \in Z_{U_i}$ in Z_{U_i} . Then let $z_{i+1} = \gamma''(t_{i+1}^-)$. Proceeding like this we can lift each segment that falls into an element of the trivialising cover. Then by lemma 2.34 we get a path $\tilde{\gamma}$ such that the endpoint $\tilde{\gamma}(0)$ is isomorphic to z . \square

DEFINITION 4.64. Let $\text{Lift}(\gamma)$ be the full subgroupoid of $\text{Path}(Z)$ (see definition 2.35) consisting of paths that lift γ . There are functors

$$ev_0: \text{Lift}(\gamma)^\delta \rightarrow Z_{\gamma(0)}, \quad ev_1: \text{Lift}(\gamma)^\delta \rightarrow Z_{\gamma(1)}$$

evaluating a path or natural transformation at 0 and 1 respectively.

PROPOSITION 4.65. *The functors ev_0 and ev_1 are weak equivalences.*

Proof. We shall prove that ev_0 is a weak equivalence, the same proof holds verbatim for ev_1 . Let $x = \gamma(0)$. Since the fibres of Z are weakly discrete, $Z_x^\delta \rightarrow Z_x$ is a weak equivalence. As $\text{Lift}(\gamma)$ has the discrete topology, it factors through Z_x^δ . But given any object $z \in Z_x$, there is a lift of γ with starting point isomorphic to z , so $\text{Lift}(\gamma) \rightarrow Z_x^\delta$ is essentially surjective, and so $\text{Lift}(\gamma) \rightarrow Z_x$ is essentially \mathcal{O} -surjective.

To show that ev_0 is fully faithful, we make use of proposition 4.59 inductively. Let $\gamma_\epsilon: \mathfrak{p}_\epsilon \rightarrow Z$ where $\epsilon = 0, 1$ be lifts of $\gamma: I \rightarrow X$, and let $a_0: \gamma_0(0) \rightarrow \gamma_1(0)$ be an arrow in $Z_{\gamma(0)}$. By passing to a common refinement $\mathfrak{q} = \mathfrak{p}_0\mathfrak{p}_1$, the paths $\gamma'_\epsilon := \gamma_\epsilon[\mathfrak{q}]$ are still lifts of γ , and an arrow between γ_0 and γ_1 in $\text{Lift}(\gamma)$ is given by a natural transformation $\gamma'_0 \Rightarrow \gamma'_1$. Let us assume then that $\mathfrak{p}_0 = \mathfrak{p}_1 = \mathfrak{p}$, which is given by $\{t_1, \dots, t_n\}$.

The segments $\text{disc}([0, t_1^-]) \rightarrow Z$ given by restricting γ_0 and γ_1 , being lifts of the same path in X , give a map $[0, t_1^-] \rightarrow Z_0 \times_X Z_0$. Since we are given the arrow $a: \gamma_0(0) \rightarrow \gamma_1(0)$, we have the diagram

$$\begin{array}{ccc} \{0\} & \longrightarrow & Z_1 \\ \downarrow & & \downarrow \\ [0, t_1^-] & \longrightarrow & Z_0 \times_X Z_0 \end{array}$$

By lemma 4.59, we have a unique lift $a^{\leq t_1}: [0, t_1^-] \rightarrow Z_1$, a path starting at a_0 , which gives a natural transformation between the functors given by the segments $\text{disc}([0, t_1^-]) \rightarrow Z$. Since we are looking for a natural transformation between paths, define a_1 as the unique arrow making this square commute

$$\begin{array}{ccc} \gamma_0(t_1^-) & \xrightarrow{\gamma_0(t_1^-, t_1^+)} & \gamma_0(t_1^+) \\ \downarrow a^{\leq t_1}(t_1^-) & & \downarrow a_1 \\ \gamma_1(t_1^-) & \xrightarrow{\gamma_1(t_1^-, t_1^+)} & \gamma_1(t_1^+) \end{array}$$

The procedure can then be iterated, lifting the map $[t_1^+, t_2^-] \rightarrow Z_0 \times_X Z_0$, defined by the next segments, to a path in Z_1 starting at a_1 . Continuing in this way we get a unique natural transformation $a: \gamma_0 \rightarrow \gamma_1$, hence ev_0 is fully faithful. By a symmetric argument, ev_1 is likewise fully faithful, and so both are weak equivalences. \square

This gives us the following pleasing result.

PROPOSITION 4.66. *Any two fibres of a 2-covering space $Z \rightarrow X$ of a path-connected base X are weakly equivalent.*

Proof. Let x, x' be any two points in X . Since it is path-connected, there is a path from x to x' . This gives, by the previous proposition, a span from Z_x to $Z_{x'}$ with weak equivalences for legs. Choosing a pseudoinverse we get an anafunctor $Z_x \dashrightarrow Z_{x'}$ which is an equivalence. \square

DEFINITION 4.67. The bicategory of 2-covering spaces of the space X , denoted $2Cov_X$, is the full sub-bicategory of $\mathbf{Ana}(\mathbf{Top}) \downarrow \text{disc}(X)$ consisting of the 2-covering spaces. The bicategory $2Cov_{(X,x)}$ of pointed 2-covering spaces of the pointed space (X, x) is the analogous full sub-bicategory of $\mathbf{Ana}_*(\mathbf{Top}) \downarrow \text{disc}(X, x)$.

Clearly all 2-arrows of $2Cov_X$ and $2Cov_{(X,x)}$ are invertible, being isotransformations.

PROPOSITION 4.68. *Let Y be a 0-connected groupoid and $Z \rightarrow X$ a 2-covering space. Given a diagram*

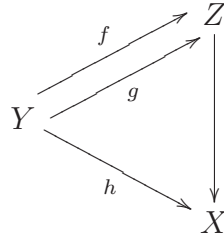

and transformations $a, b: f \Rightarrow g$ over X , if there is an object $y \in Y_0$ such that $a_y = b_y$, then $a = b$.

Proof. Given y, a and b , and another object $y' \in Y_0$, let $\gamma: \mathbf{p} \rightarrow Y$ be a path from y to y' . Then the paths $f \circ \gamma, g \circ \gamma$ are lifts of $h \circ \gamma$, and $a \circ 1_\gamma$ and $b \circ 1_\gamma$ are natural transformations between them. We know by proposition 4.65 that ev_0 is faithful, and since $ev_0(a \circ 1_\gamma) = a_y = b_y = ev_0(b \circ 1_\gamma)$, we see that $a \circ 1_\gamma = b \circ 1_\gamma$. Applying ev_1 we get $a_{y'} = a_{y'}$, and this is true for all $y' \in Y_0$, so $a = b$. \square

COROLLARY 4.69. *Let (Y, y) be a 0-connected pointed groupoid and $(Z, z) \rightarrow (X, x)$ a 2-covering space. Given a diagram*

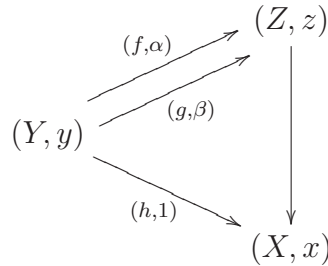

there is at most one pointed transformation $(f, \alpha) \Rightarrow (g, \beta)$ over X .

Proof. As a and b are pointed transformations, they have a prescribed value at y , namely $a_y = b_y = \beta_y \circ \alpha_y^{-1}$. The result follows from the proposition. \square

REMARK 4.70. In the normal theory of covering spaces, the analogous result is that given a lift of a pointed map to the base space of a pointed covering space, it is unique. However, the proof takes a different tack, showing that the subspace on which any two lifts agree is both open and closed. It is not clear what the notions of open and closed subgroupoids are, hence the choice of hypotheses.

PROPOSITION 4.71. *If $(U, f), (V, g)$ are 1-arrows in $2Cov_{(X,x)}^{conn}$, there is at most one 2-arrow between them.*

Proof. Assume that f and g share the same source and target. They are then given by spans

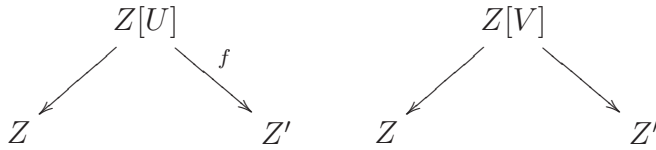

where we have suppressed the basepoints for clarity. Any 2-arrow $(U, f) \Rightarrow (V, g)$ is given by a diagram

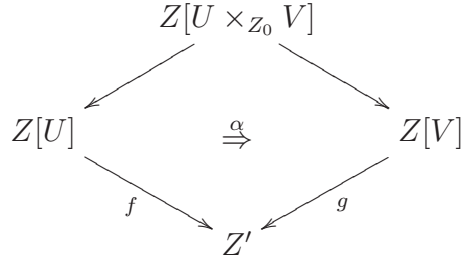

By proposition 4.52, $Z[U \times_{Z_0} V]$ is a 2-covering space as it is weakly equivalent to Z , and since weak equivalences are sent by π_0 to isomorphisms, $Z[U \times_{Z_0} V]$ is 0-connected. We can then apply corollary 4.69 to see there is at most one natural transformation between the functors $Z[U \times_{Z_0} V] \rightarrow Z'$. \square

Hence $2Cov_{(X,x)}$ is a category weakly enriched in posets, that is, a bicategory with posets for hom-categories. Such a thing is called a *2-poset* in the appendix by Mike Shulman in [BS10] and a *2-order* by Matthieu Dupont [Dup08b].⁵ It is slightly nicer than a general 2-poset however, as all 2-arrows are invertible. This is recorded in the following theorem.

THEOREM 4.72. *The bicategory $2Cov_{(X,x)}$ is equivalent to a category.*

We shall not utilise this fact, however, preferring to work with the bicategory. This does have the rather pleasant side effect that coherence morphisms, such as the associator, are canonically defined, being the unique 2-arrow between their source and target. We know these exist, because they are inherited from \mathbf{Ana}_* . We also get for free a coherence theorem: any composites of 2-arrows are equal iff they share the same source and target.

⁵But note that Dupont takes a more foundational view of such things than is done in this thesis.

If we consider unpointed 0-connected 2-covering spaces, then we do not have the same uniqueness of 2-arrows, but the set of 2-arrows is bounded by the set of arrows of a skeleton of a typical fibre.⁶ If the fibre is a finite groupoid or is transitive with finite automorphism groups, and the hypotheses of proposition 4.68 are satisfied, we can see that the set of transformations between two functors is finite.

A main result of this chapter is an analogue for 2-covering spaces of proposition 4.10. To achieve this aim we need to consider lifting of homotopies between surfaces. As always the lift will be constructed inductively over regions, so we will approach the proof by several lemmas. First, we need to know that if a 2-covering space $Z \rightarrow X$ is trivialisable, we can lift in the following situation

$$\begin{array}{ccc}
 J & \longrightarrow & Z \\
 \downarrow & \nearrow & \downarrow \\
 I^3 & \longrightarrow & X
 \end{array}$$

where $J \subseteq \partial I^3$ is a 1-connected subspace consisting of a union of faces. For example, the subspaces

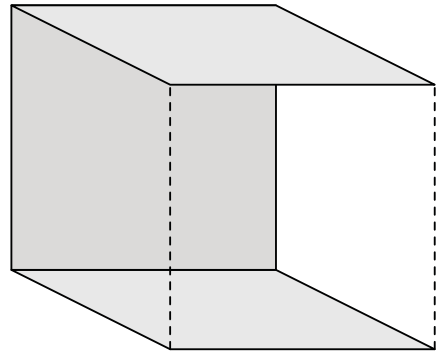
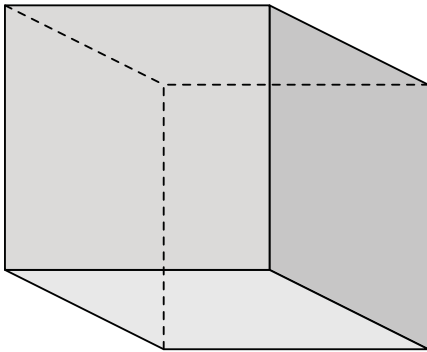

are valid choices, but this subspace

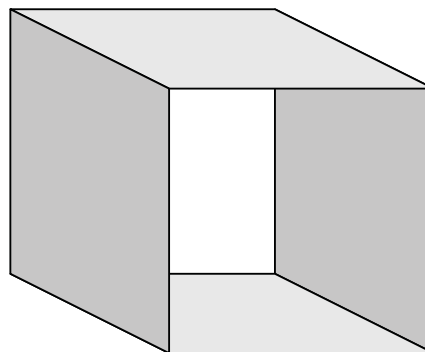

⁶The object ‘skeleton of a typical fibre’ is unique for 2-covering spaces of path-connected spaces, as all fibres are weakly equivalent weakly discrete groupoids, hence have equivalent underlying t-g groupoids.

is not.

Actually we need a generalisation of this where J is replaced by a 1-connected Čech groupoid $\mathfrak{B} = \check{C}(\underline{\mathfrak{B}})$ where $\underline{\mathfrak{B}}$ is a closed cover of J of a certain form.

DEFINITION 4.73. A *boundary 2-partition* is a finite closed cover $\underline{\mathfrak{B}} = \coprod_{i=1}^N R_i \rightarrow J$ for J as above where each region R_i is

- a rectangle in a face $I^2 \subset J$, or
- the intersection of a cuboid $[r_1, r_2] \times [s_1, s_2] \times [t_1, t_2] \subset I^3$ with J ,

and such that the intersection $R_i \cap R_j$ for $i \neq j$ is at most one-dimensional. The associated Čech groupoid $\mathfrak{B} := \check{C}(\underline{\mathfrak{B}})$ is called a *boundary 2-partition groupoid*.

The usual notions of refinement hold for boundary 2-partitions just as they do for n -partitions. In addition, if $\mathfrak{B} \rightarrow J$ is a boundary 2-partition groupoid and \mathfrak{H} is a 3-partition groupoid, there is a boundary 2-partition groupoid $\mathfrak{B}\mathfrak{H}$ which is the Čech groupoid associated to the common refinement of $\underline{\mathfrak{B}}$ and $\underline{\mathfrak{H}} \times_{I^3} J$. Also note that the identity map $J \rightarrow J$ is a boundary 2-partition, being the intersection of I^3 with J . We can also define boundary 2-partitions of arbitrary regions $[a, b] \times [c, d] \times [e, f]$.

LEMMA 4.74. *Given an open cover $U \rightarrow J$ of a subspace $J \subset I^3$ as described above, there is a boundary 2-partition $\underline{\mathcal{R}} \rightarrow J$ refining it:*

$$\begin{array}{ccc} & & U \\ & \nearrow & \downarrow \\ \underline{\mathcal{R}} & \longrightarrow & J \end{array}$$

Proof. Exactly as lemma 2.19. □

In the proof of theorem 4.81 we need to be able to extend, up to isomorphism, functors from boundary 2-partition groupoids to t - d groupoids across the cube or 3-partition groupoid. We shall state necessary result with a little more generality, however.

LEMMA 4.75. *Let Y be a 1-connected groupoid. Any functor $g: Y \rightarrow D$ with D a t - d groupoid factors as*

$$\begin{array}{ccc} Y & \xrightarrow{g} & D \\ & \searrow & \parallel \alpha \\ & & * \\ & \nearrow & \nearrow g(y_0) \end{array}$$

for any object $y_0 \in Y_0$.

Proof. First recall the 2-functor $comp: \Pi_2(D) \rightarrow D$ from proposition 2.117, which sends a path $\eta: \mathfrak{p} \rightarrow D$ to the composite of the string of arrows it defines. Also recall that $comp$ sends surfaces between paths to equalities, and that $comp$ necessarily respects concatenation of paths. Let $i_\Pi: Y \rightarrow \Pi_2(Y)$ denote the 2-functor from proposition 2.116, which sends arrows in Y to paths $\mathfrak{d} \rightarrow Y$. For an arrow $a \in Y_1$, it is easy to see that $comp(g(i_\Pi(a))) = g(a)$. We now define the

natural transformation α as follows: for any object $y \in Y_0$, choose a path $\gamma_y: \mathfrak{p} \rightarrow Y$ such that $\gamma_y(0) = y_0$ and $\gamma_y(1) = y$. Let

$$\alpha_y := \text{comp}(g \circ \gamma_y) \in D_1.$$

If γ'_y is any other such path, there is a surface between it and γ_y , so any choice of path defines the same arrow in D . The components of α are thus well-defined. Now we need to show naturality, that is given an arrow $a: y \rightarrow y'$ in Y , that $\alpha_{y'} = g(a) \circ \alpha_y$. Notice that $i_\Pi(a) \cdot \gamma_y$ is a path from y_0 to y' , and so there is a surface between it and $\gamma_{y'}$, hence we have

$$\begin{aligned} \alpha_{y'} &= \text{comp}(g \circ \gamma_{y'}) \\ &= \text{comp}(g \circ (i_\Pi(a) \cdot \gamma_y)) \\ &= \text{comp}(g \circ i_\Pi(a)) \circ \alpha_y \\ &= g(a) \circ \alpha_y \end{aligned}$$

as required. □

To apply this to the case at hand we need to know that \mathfrak{B} is 1-connected – this does not follow from any of the computations at the end of chapter 2 as $\mathfrak{B} \rightarrow J$ is not a weak equivalence.

LEMMA 4.76. *A boundary 2-partition groupoid \mathfrak{B} is 1-connected.*

Proof. By assumption, the space J is 1-connected. Hence for any two objects in \mathfrak{B} there is a path between their images in J , which path can be lifted to a path in \mathfrak{B} . Thus \mathfrak{B} is 0-connected.

A path in a boundary 2-partition groupoid picks out a sequence of regions R_i , $i = 0, \dots, n$ possibly with repetition, with $R_i \cap R_{i+1} \subset J$ nonempty, and consists of a segment $[t_i, t_{i+1}] \rightarrow R_i$ in each region such that t_i and t_{i+1} are mapped to the boundary of the region. For any path $\gamma: \mathfrak{p} \rightarrow \mathfrak{B}$ one can easily construct a surface $f: \mathfrak{h} \rightarrow \mathfrak{B}$ such that $s_1(f) = \gamma$ and $t_1(f)$ is a path that has each segment $[t_i, t_{i+1}] \rightarrow R$ running around the boundary of the region R . The endpoints of the path may of course be in the interior of the regions in which they fall. In this instance, we let the initial part of the segment be a straight line from the endpoint to the nearest boundary, and then continue as before. If we are given a pair of paths γ_0, η between the same endpoints, we can assume that they have the same domain, as otherwise we can pass to refinements, and supply surfaces between the refined paths and the original paths. We can also assume that in the list of regions R_1, \dots, R_k that any repetitions are not adjacent, that is, we do not have $R_i = R_{i+1}$. This is because we can always remove the identity arrow joining those two segments (recall that since \mathfrak{B} is a Čech groupoid, there is at most one arrow between an ordered pair of objects).

By applying the argument above we see that we only need to construct a surface between paths whose image is in the boundary of the regions of \mathfrak{B} . If we map the paths in \mathfrak{B} down to J , we can find a homotopy between them. Consider the full subgroupoid B_0 of \mathfrak{B} which is the preimage of the image of this homotopy. Let N

be the number of connected components of the object space of B_0 . The following picture gives an idea of this, under the assumption that the endpoints are in the boundaries of regions. The shaded regions and the two paths, γ_0 (red, top) and η (green, bottom), define the objects of B_0

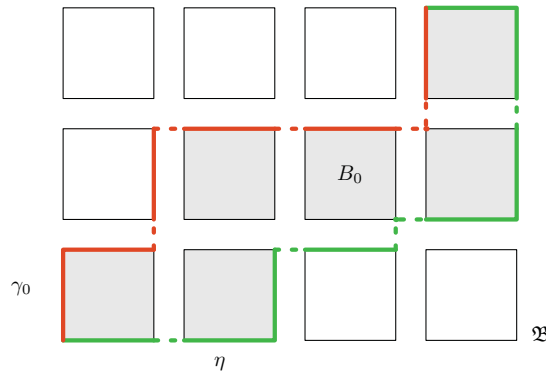

We will inductively define new paths, joined to the old by surfaces, and subgroupoids of \mathfrak{B} with fewer connected components in the object space. We can continue this until the two paths we have are equal. There is clearly a natural transformation between the paths γ_0 and γ'_0 represented in red (left) and blue (right) respectively in these two pictures:

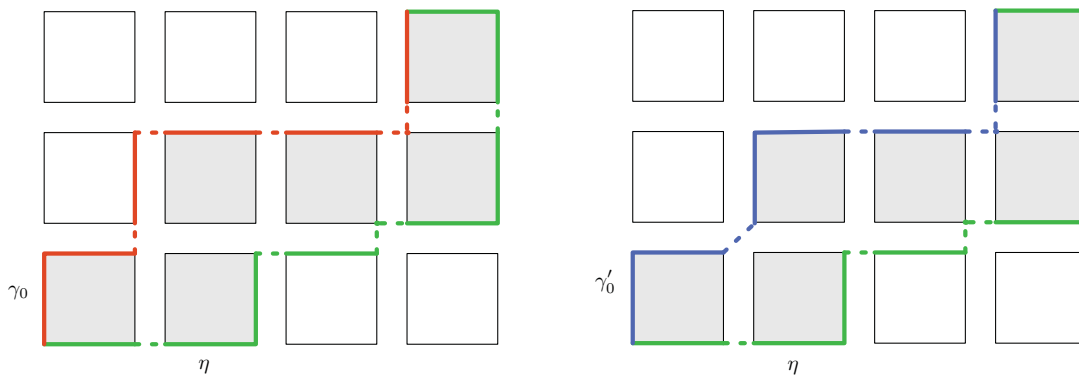

There is a surface g_1 between them, as the natural transformation is the identity on the endpoints. There is then a homotopy moving the path across the region, which can be used to construct a surface $g'_1 : I \times \mathfrak{p} \rightarrow \mathfrak{B}$. Denote by γ_1 the path $t_1(g_1)$, as shown again in blue:

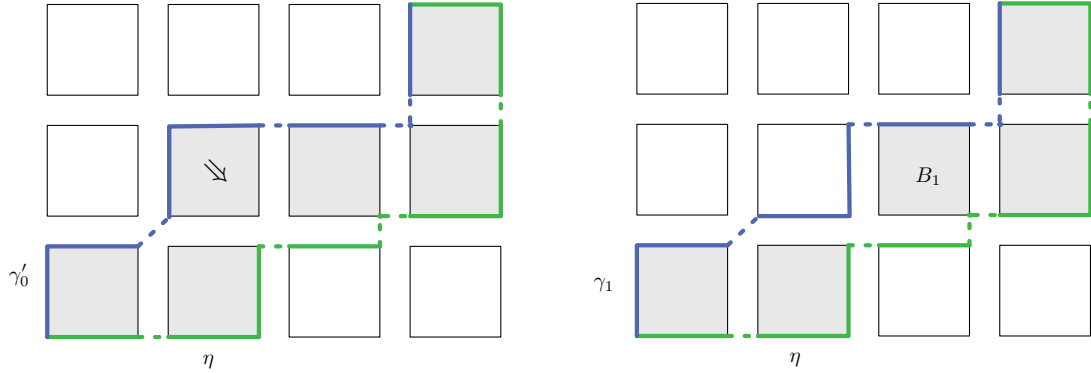

We now have another subgroupoid $B_1 \hookrightarrow \mathfrak{B}$ with one less connected component in its object space, defined as the preimage of the homotopy between the paths γ_1 and η . Continue in this way until we get to a γ_k that is equal to η . The composition of all the surfaces $g_1, g'_1, \dots, g_k, g'_k$ gives a surface between γ_0 and η , hence \mathfrak{B} is 1-connected. \square

REMARK 4.77. The same algorithm can be used to define a surface between any two paths in an n -partition groupoid \mathcal{R} , giving the result that \mathcal{R} is 1-connected, but we will not need this fact here. It is also true that \mathfrak{B} and indeed any \mathcal{R} is 2-connected, but we leave it as an exercise for the reader.

LEMMA 4.78. For a boundary 2-partition groupoid \mathfrak{B} of some $J \subset I^3$ as above and functor $g: \mathfrak{B} \rightarrow D$, there is a square

$$\begin{array}{ccc}
 \mathfrak{B} & \xrightarrow{g} & D \\
 \downarrow & \searrow & \uparrow \\
 I^3 & \longrightarrow & *
 \end{array}$$

Proof. Since \mathfrak{B} is 1-connected, we can apply lemma 4.75 to get a triangle

$$\begin{array}{ccc}
 \mathfrak{B} & \xrightarrow{g} & D \\
 \searrow & \Downarrow & \nearrow \\
 & * &
 \end{array}$$

which can be easily extended to the required square. \square

Note that if J were not 1-connected, \mathfrak{B} would not be 1-connected, and then g would not factor through a trivial groupoid, but would pick out an automorphism of the image of a given point in \mathfrak{B} , and g would only be extendible if this automorphism was the identity.

LEMMA 4.79. Let $Z \rightarrow X$ be a trivialisable 2-covering space, with trivialisation $(W, \phi): Z \rightarrow X \times D$. Let J be a 1-connected subspace of I^3 as discussed, $\mathfrak{B} \rightarrow J$ a

boundary partition groupoid, and consider a pair of functors $f_J : \mathfrak{B} \rightarrow Z_0$, $f : I^3 \rightarrow X$ such that the following commutes

$$\begin{array}{ccc} \mathfrak{B} & \xrightarrow{f_J} & Z \\ \downarrow & & \downarrow \\ I^3 & \xrightarrow{f} & X \end{array}$$

There is a 3-partition $\mathfrak{H} \rightarrow I^3$, a functor $\mathfrak{H} \rightarrow Z$ lifting f and a natural transformation, as in the diagram

$$\begin{array}{ccccc} & & \mathfrak{B}'\mathfrak{H} & & \\ & \swarrow & \downarrow & \searrow & \\ \mathfrak{B} & \xrightarrow{\quad} & Z & & \\ \downarrow & & \downarrow & \nearrow & \downarrow \\ I^3 & \xrightarrow{f} & X & & \end{array}$$

\mathfrak{H}

where $\mathfrak{B}' \rightarrow \mathfrak{B}$ is a refinement.

Proof. Let the trivialisation be $(W, \phi) : Z \dashrightarrow X \times D$. Using a variation on lemma 2.119 (the proof is almost identical, so we omit it), we can find a refinement $\mathfrak{B}' \rightarrow \mathfrak{B}$ so that $f_J[\mathfrak{B}']$ lifts to $Z[W]$, and we get a functor

$$\mathfrak{B}' \xrightarrow{\widehat{f_J}} Z[W] \xrightarrow{\phi} X \times D.$$

By lemma 4.78 there is no obstruction to finding a lift of f to $X \times D$ agreeing up to isomorphism with $\phi \circ \widehat{f_J}$ on \mathfrak{B}'

$$\begin{array}{ccc} \mathfrak{B}' & \xrightarrow{\phi \circ \widehat{f_J}} & X \times D \\ \downarrow & \Downarrow & \downarrow \\ I^3 & \xrightarrow{f} & X \end{array}$$

\widehat{f}

Given \widehat{f} we consider an ana-inverse

$$X \times D \leftarrow (X \times D)[\overline{W}] \xrightarrow{\overline{\phi}} Z$$

to ϕ . We can find a 3-partition groupoid \mathfrak{H} such that there is a lift of $\widehat{f}[\mathfrak{H}]$ to $(X \times D)[\overline{W}]$:

$$\begin{array}{ccc} \mathfrak{H} & \xrightarrow{g} & (X \times D)[\overline{W}] \\ \downarrow & & \downarrow \\ I^3 & \xrightarrow{\widehat{f}} & X \times D \end{array}$$

Composing g with the $\overline{\phi}$ gives us the sought-after lift of f to Z . We then just need to construct the natural transformation between f_J and $\overline{\phi} \circ g$. Note that there is a refinement $\mathfrak{B}'\mathfrak{H} \rightarrow \mathfrak{B}'$ of the boundary 2-partition groupoid, which gives a diagram

$$\begin{array}{ccccc} & & \mathfrak{B}' & & \\ & \nearrow & \downarrow & \searrow & \\ \mathfrak{B}'\mathfrak{H} & & I^3 & \xrightarrow{\widehat{f}_J} & (X \times D)[\overline{W}] \\ & \searrow & \uparrow & \swarrow & \\ & & \mathfrak{H} & \xrightarrow{g} & (X \times D)[\overline{W}] \end{array}$$

which furnishes us with a natural transformation

$$\begin{array}{ccccc} \mathfrak{B}'\mathfrak{H} & \longrightarrow & \mathfrak{B}' & \xrightarrow{\widehat{f}_J} & (X \times D)[\overline{W}] \\ \downarrow & & \downarrow & \Downarrow & \searrow \\ \mathfrak{H} & \xrightarrow{g} & & & X \times D \\ & & & & \swarrow \\ & & & & (X \times D)[\overline{W}] \end{array}$$

As the canonical functor $(X \times D)[\overline{W}] \rightarrow X \times D$ is fully faithful, this lifts to a natural transformation

$$\begin{array}{ccc} \mathfrak{B}'\mathfrak{H} & \longrightarrow & \mathfrak{B}' \\ \downarrow & & \downarrow \widehat{f}_J \\ \mathfrak{H} & \xrightarrow{g} & (X \times D)[\overline{W}] \end{array}$$

and so gives us the desired transformation. □

Now that we know we can lift for trivialisable 2-covering spaces, we can consider a general 2-covering space and its local trivialisations. The idea is that we can cover I^3 by a finite number of regions which factor through elements of a trivialising cover $U \rightarrow X$, then by induction lift region by region. We needed to consider varying $J \subset \partial I^3$ as the number of faces of the regions on which the lift will be previously defined will vary. In particular, the last region over which we shall lift will have the lift already defined over all six faces.

To ‘glue’ the lifts over various trivialisations together, we shall need a lemma that turns components of natural transformations into arrow components of functors.

LEMMA 4.80. *Let $U \rightarrow M$ and $V \rightarrow M$ be maps of spaces. Given a natural transformation*

$$\begin{array}{ccc} \check{C}(U) \times_M \check{C}(V) & \longrightarrow & \check{C}(U) \\ \downarrow & \searrow a & \downarrow \\ \check{C}(V) & \longrightarrow & \text{disc}(M) \end{array}$$

and functors $f: \check{C}(U) \rightarrow X$, $g: \check{C}(V) \rightarrow X$, there is a functor

$$f\#_a g: \check{C}(U \amalg V) \rightarrow X$$

agreeing with $f \amalg g$ on objects.

Proof. First note that there is an inclusion $\check{C}(U) \amalg \check{C}(V) \hookrightarrow \check{C}(U \amalg V)$ which is the identity on objects. We thus set $(f\#_a g)_0 = f_0 \amalg g_0$. The space of arrows of $\check{C}(U \amalg V)$ is isomorphic to

$$\check{C}(U)_1 \amalg \check{C}(V)_1 \amalg U \times_M V \amalg V \times_M U$$

and so we define the arrow component of $f\#_a g$ as

$$(f\#_a g)_1 := f_1 \amalg g_1 \amalg a \amalg -a,$$

where we recall from chapter 1 that $-a = (-)^{-1} \circ a$. We need to show that $f\#_a g$ preserves the composition of an arrow from one of $\check{C}(U)$, $\check{C}(V)$ and an arrow in $U \times_M V \amalg V \times_M U$, and the composition of a pair of arrows from the latter. The identity arrows and all the other compositions are preserved automatically.

Consider the square that encodes the naturality of a , namely

$$\begin{array}{ccc} f(u_1, v_1) & \xrightarrow{a_{u_1, v_1}} & g(u_1, v_2) \\ \downarrow f(u_1, u_2) & & \downarrow g(v_1, v_2) \\ f(u_2, v_2) & \xrightarrow{a_{u_2, v_2}} & g(u_2, v_2) \end{array}$$

Then by setting $v_1 = v_2$ (resp. $u_1 = u_2$), and hence $g(v_1, v_2) = g(v_1, v_1) = id_{g(v_1)}$ (resp. $f(u_1, u_2) = id_{f(u_1)}$), and substituting inverses where needed, we have a pair of commuting triangles

$$\begin{array}{ccc}
 f(u_1, v_1) & & f(u_1, v_1) \xrightarrow{a_{u_1, v_1}} g(u_1, v_2) \\
 \downarrow f(u_1, u_2) & \searrow a_{u_1, v_1} & \downarrow g(v_1, v_2) \\
 f(u_2, v_1) & \xrightarrow{a_{u_1, v_1}} & g(u_2, v_1) \\
 & & \downarrow a_{u_2, v_2} \\
 & & g(u_1, v_2)
 \end{array}$$

which gives us the result that $f\#_a g$ preserves composition. \square

THEOREM 4.81. *If $p: Z \rightarrow X$ is a 2-covering space, $\Pi_2(Z) \rightarrow \Pi_2(X)$ is locally faithful.*

Proof. Let $\gamma_\epsilon: \mathfrak{p}_\epsilon \rightarrow Z$, $\epsilon = 0, 1$, be paths with matching endpoints, and let $f_\epsilon: \mathfrak{h}_\epsilon \rightarrow Z$, $\epsilon = 0, 1$, be a pair of surfaces between them such that $p_*[f_0] = p_*[f_1]$. We will assume that f_0 and f_1 are collared, as is the homotopy $F: \mathfrak{H} \rightarrow X$ witnessing the equality $p_*[f_0] = p_*[f_1]$ (using remark 2.121). This setup means we have the following diagram

$$\begin{array}{ccc}
 \partial\mathfrak{H} & \longrightarrow & Z \\
 \downarrow & & \downarrow \\
 \mathfrak{H} & \xrightarrow{F} & X
 \end{array}$$

We can lift the collar to Z , in the same way as the proof of proposition 2.120. We are thus given, up to scaling, the following lifting problem

$$\begin{array}{ccc}
 \partial\mathfrak{H} & \xrightarrow{F_0} & Z \\
 \downarrow & \nearrow & \downarrow \\
 \mathfrak{H} & \xrightarrow{F} & X
 \end{array}$$

where \mathfrak{H} is now a regular 3-partition groupoid such that the object component of F , $\mathfrak{H} \rightarrow X$, factors through a trivialising cover for Z .

Denote the region $[r_i, r_{i+1}] \times [s_j, s_{j+1}] \times [t_k, t_{k+1}]$ for $i = 0, \dots, l$, $j = 0, \dots, m$ and $k = 0, \dots, n$ by (ijk) and order the regions lexicographically, as in the proof of proposition 2.129. We shall inductively define a lift using this ordering. Let $\mathcal{L}_0 = \partial\mathfrak{H}$, and let \mathcal{L}_p be the domain of the lift after step $p = i_0(n+1)(m+1) + j_0(n+1) + k_0$.

This groupoid is a refinement of the full subgroupoid of \mathfrak{H} on the objects

$$\partial\mathfrak{H}_0 \quad \prod_{\substack{i=i_0, j=j_0, \\ k=k_0-1 \\ i,j,k=0}} (ijk),$$

and the objects of this groupoid form a closed cover of the subspace

$$\partial I^3 \quad \bigcup_{\substack{i=i_0, j=j_0, \\ k=k_0-1 \\ i,j,k=0}} (ijk) \subset I^3.$$

Suppose we are given a lift on \mathcal{L}_p , and that $k_0 < n$ and $p > 1$. That is, there is a square of functors

$$\begin{array}{ccc} \mathcal{L}_p & \longrightarrow & Z \\ \downarrow & & \downarrow \\ I^3 & \longrightarrow & X \end{array}$$

Then the pullback

$$\begin{array}{ccc} (i_0 j_0 k_0) \times_{I^3} \mathcal{L}_p & \longrightarrow & \mathcal{L}_p \\ \downarrow & & \downarrow \\ (i_0 j_0 k_0) & \longrightarrow & I^3 \end{array}$$

defines a boundary 2-partition $\mathfrak{B}_{i_0 j_0 k_0}$ of $(i_0 j_0 k_0)$ (this is where we use $k_0 < n$, otherwise substitute $(i_0 \ j_0 + 1 \ 0)$ or $(i_0 + 1 \ 0 \ 0)$ as appropriate). We then can use lemma 4.79 to obtain a lift for the diagram

$$\begin{array}{ccc} \mathfrak{B}_{i_0 j_0 k_0} & \xrightarrow{f_{i_0 j_0 k_0}} & Z \\ \downarrow & & \downarrow \\ (i_0 j_0 k_0) & \xrightarrow{F|_{i_0 j_0 k_0}} & X \end{array}$$

That is, we have a diagram of functors and natural transformations

$$\begin{array}{ccc}
 & \mathfrak{B}'\mathfrak{H}_{i_0j_0k_0} & \\
 & \swarrow \quad \downarrow \quad \searrow & \\
 \mathfrak{B}_{i_0j_0k_0} & \xrightarrow{\quad} & Z \\
 \downarrow & \nearrow \quad \downarrow \quad \nearrow & \downarrow \\
 (i_0j_0k_0) & \xrightarrow{\quad f \quad} & X
 \end{array}$$

where $\mathfrak{H}_{i_0j_0k_0}$ is a 3-partition of $(i_0j_0k_0)$. Since we have had to pass to a refinement $\mathfrak{B}' \rightarrow \mathfrak{B}_{i_0j_0k_0}$, we refine \mathcal{L}_p to \mathcal{L}'_p such that we have the inclusion of a subgroupoid $\mathfrak{B}' \hookrightarrow \mathcal{L}'_p$. This at most alters the 3-partitions of the regions adjacent to $(i_0j_0k_0)$. Over the course of the construction of the lift, any given 3-partition groupoid is refined at most three times.

This then gives us two functors, $\mathcal{L}'_p \rightarrow Z$ and $\mathfrak{H}_{i_0j_0k_0} \rightarrow Z$ and a transformation

$$\begin{array}{ccc}
 \mathfrak{B}'\mathfrak{H}_{i_0j_0k_0} & \xrightarrow{\quad} & \mathfrak{H}_{i_0j_0k_0} \\
 \downarrow & \nearrow \quad \downarrow & \downarrow \\
 \mathfrak{B}' & \xrightarrow{\quad} & Z
 \end{array}$$

Since by an easy variant of lemma 2.21 there is an internal equivalence of groupoids

$$\mathfrak{B}' \times_{I^3} \mathfrak{H}_{i_0j_0k_0} \rightarrow \mathfrak{B}'\mathfrak{H}_{i_0j_0k_0}$$

and hence a transformation

$$\begin{array}{ccc}
 \mathfrak{B}' \times_{I^3} \mathfrak{H}_{i_0j_0k_0} & \xrightarrow{\quad} & \mathfrak{H}_{i_0j_0k_0} \\
 \downarrow & \nearrow \quad \downarrow & \downarrow \\
 \mathcal{L}'_p & \xrightarrow{\quad} & Z
 \end{array}$$

which uses the fact there is an isomorphism $\mathcal{L}'_p \times_{I^3} \mathfrak{H}_{i_0j_0k_0} \cong \mathfrak{B}' \times_{I^3} \mathfrak{H}_{i_0j_0k_0}$. By lemma 4.80 we get a functor

$$\mathcal{L}_{p+1} := \check{C}(\mathcal{L}'_p \amalg \mathfrak{H}_{i_0j_0k_0}) \rightarrow Z.$$

Continuing in this way we have a lift of F as required. This implies that $[f_0] = [f_1]$ and so p_* is locally faithful. \square

An important corollary to this theorem, and indeed a central motivation for it, occurs when $Z \rightarrow X$ is pointed, which, as it is strictly pointed, induces a homomorphism of 2-groups

$$\Pi_2(Z, z) \rightarrow \Pi_2(X, x).$$

We need to first discuss some terminology for 2-groups.

DEFINITION 4.82. Let G be a 2-group. Then a sub-2-group is a 2-group H equipped with a homomorphism $H \rightarrow G$ which is faithful as a functor (or if thought of as a 2-functor, locally faithful). We shall denote a sub-2-group by $H \twoheadrightarrow G$.

Evidence to motivate this definition comes from the thesis [Dup08a], where symmetric 2-groups were studied in the context of categorifying abelian categories. In [CGV06] *normal* sub-2-groups were defined as faithful functors plus some more structure (making the functor a *categorical crossed module*). This was justified in that every kernel of a homomorphism of 2-groups carries this structure, there is a weak quotient 2-group of a 2-group by a normal sub-2-group and every normal sub-2-group is the kernel of the quotient homomorphism (my thanks to Matthieu Dupont for pointing this out to me). Discussions at [nLa] also came to the conclusion that this was the definition that should be adopted based on considerations of categorified homogeneous geometry.

COROLLARY 4.83. For $(Z, z) \rightarrow (X, x)$ a 2-covering space, $\Pi_2(Z, z) \rightarrow \Pi_2(X, x)$ is a sub-2-group.

This is proposed as further evidence that this is the correct definition of sub-2-group. In fact, one would hope that 2-covering spaces could be used in combinatorial group theory, or combinatorial 2-group theory, to import some geometric insight.

In fact, in light of the close link between covering spaces and covering maps of groupoids given by the fundamental groupoid functor (as detail by [Bro06], for example), it is to be expected that the strict 2-functor $\Pi_2(Z) \rightarrow \Pi_2(X)$ (and also the composite $\Pi_2(Z) \rightarrow \Pi_2^T(X)$) is some sort of fibration of bigroupoids. While a couple of authors have considered fibrations of 2- or bicategories [Her99, Bak], the details are not well adapted to the problem at hand. In comparison, the definition of a covering map of groupoids is far simpler than the definition of fibration of categories. In addition, the sort of lifting (of paths, for argument's sake) that 2-covering spaces admit is more akin to the weak homotopy lifting that Dold fibrations admit [Dol63], than that of Serre fibrations. This sort of feature is not considered in the cited articles. The idea of a fibration of bigroupoids, where the fibres are groupoids, definitely warrants further investigation.

5. 2-covering spaces and bundle gerbes

We saw in example 4.50 that the groupoid $S^3 \rtimes \mathbb{R}$ over S^2 is a 2-covering space. This groupoid is an example of a *$U(1)$ -bundle gerbe* [Mur96], see also [Mur09] for a good introduction with historical comments as well as coverage of more recent developments and applications. It is the so-called *lifting* bundle gerbe for the principal $U(1)$ -bundle $S^3 \rightarrow S^2$ and the central extension $\mathbb{Z} \rightarrow \mathbb{R} \rightarrow U(1) = \mathbb{Z}$. We

shall see that this result is true for any lifting bundle gerbe associated to a principal BA -bundle and central extension of topological groups $A \rightarrow EA \rightarrow BA$, where $EA \rightarrow BA$ is the universal bundle for the discrete group A . But first, we need to define bundle gerbes and lifting bundle gerbes, albeit in a slightly non-standard (but equivalent) way, purely for economy of language.

DEFINITION 4.84. Let A be an abelian topological group. An A -bundle gerbe on a space X is a groupoid $E \rightarrow X$ over X such that $E_0 \rightarrow X$ admits local sections and $E_1 \rightarrow E_0 \times_X E_0$ is a principal A -bundle, trivial over the image of $\Delta: E_0 \rightarrow E_0 \times_X E_0$. When the group A is not important or implicitly understood, we can just refer to a bundle gerbe.

The traditional definition of a bundle gerbe does not explicitly mention that E is a groupoid, rather encoding this fact by describing certain sections of products of bundles over (iterated) pullbacks. In the original article [Mur96] however, the author makes it clear he knew that he was dealing with a bundle of transitive groupoids, all of whose automorphism groups were isomorphic to a given group (in that article, $A = \mathbb{C}^\times$).

EXAMPLE 4.85. Let $A \rightarrow G \rightarrow H$ be a central extension of topological groups,⁷ and let $P \rightarrow X$ be a principal H -bundle. There is a functor $\tau: P \rtimes H \rightarrow \mathbf{B}H$, induced by the map $P \rightarrow *$ of spaces with an H -action. The groupoid $P \rtimes G$ given by the pullback square

$$\begin{array}{ccc} P \rtimes G & \longrightarrow & \mathbf{B}G \\ \downarrow & & \downarrow \\ P \rtimes H & \xrightarrow{\tau} & \mathbf{B}H \end{array}$$

is an A -bundle gerbe over X , called a *lifting* bundle gerbe. It is the obstruction to lifting the structure group of P to G (see [Mur96] for the $A = \mathbb{C}^\times$ case, the general case is easily derived using the same arguments).

First, a lemma involving central extensions. Let $H \rtimes G$ be the action groupoid for the usual action of G on H by a homomorphism $G \rightarrow H$.

LEMMA 4.86. *For a central extension of abelian topological groups $A \rightarrow G \rightarrow H$ there is a weak equivalence $\mathbf{B}A \rightarrow H \rtimes G$ which sends the single object of $\mathbf{B}A$ to the identity element of H and is the obvious inclusion on arrows.*

Proof. That the functor is fully faithful is almost a tautology, as A is the kernel of $G \rightarrow H$ and is precisely the stabiliser subgroup of $1_H \in H$. To show it is essentially \mathcal{O} -surjective, note that we need to show that

$$* \times_{H, \text{pr}_1} (H \times G) \rightarrow H \times G \xrightarrow{\text{act}} H$$

⁷We will always assume that for a (central) extension of topological groups, the surjection $G \rightarrow H$ admits local sections

admits local sections. The leftmost space is just $\{1_H\} \times G \simeq G$, and hence this map is simply the homomorphism $G \rightarrow H$, which by assumption admits local sections. \square

EXAMPLE 4.87. An example of such a central extension is the universal A -bundle $A \rightarrow EA \rightarrow BA$, with the spaces EA, BA given their usual abelian group structures.⁸ For our purposes we restrict attention to the universal A -bundle for *discrete* groups A .

EXAMPLE 4.88. Another example of a central extension of homotopical interest is the universal covering space of a 1-well-connected topological group G , which naturally inherits the structure of a topological group:

$$\pi_1(G, 1) \rightarrow G^{(1)} \rightarrow G$$

and the kernel can be identified with the fundamental group of G , which is always abelian. A principal G -bundle then determines a $\pi_1(G)$ -bundle gerbe.

Note that the central extension $\mathbb{Z} \rightarrow \mathbb{R} \rightarrow S^1$ provides an example of both of these sorts of central extensions, as does the universal covering space of a topological group that is a connected 1-type (assuming the universal covering space exists).

PROPOSITION 4.89. *Let A be a discrete abelian group, $A \rightarrow G \rightarrow H$ a central extension of topological groups, and $P \rightarrow X$ a principal H -bundle. The lifting bundle gerbe $P \rtimes G$ is a 2-covering space.*

Proof. Let $U = \coprod U_\alpha \rightarrow X$ be a trivialising open cover for P . There are isomorphisms of groupoids over U_α ,

$$(P \rtimes G) \times_X U_\alpha \simeq P_{U_\alpha} \rtimes G \simeq U_\alpha \times H \rtimes G$$

where the latter action of G is on the H factor via the homomorphism $G \rightarrow H$. From lemma 4.86 we have the result that $\mathbf{B}A \rightarrow H \rtimes G$ is a weak equivalence, so there is an anafunctor pseudoinverse $H \rtimes G \dashrightarrow \mathbf{B}A$. This gives us an equivalence

$$\begin{array}{ccc} (P \rtimes G) \times_X U_\alpha & \xrightarrow{\sim} & U_\alpha \times \mathbf{B}A \\ & \searrow & \swarrow \\ & U_\alpha & \end{array}$$

in **TopAna** over U_α . Since A is discrete, $\mathbf{B}A$ is a t-d groupoid and we are done. \square

The question of whether a general A -bundle gerbe is a 2-covering space will be dealt with elsewhere.

A 2-covering space with transitive fibres is not necessarily an A -bundle gerbe but an example of a non-abelian bundle gerbe, or more correctly, a *not-necessarily-abelian* bundle gerbe. There have been several approaches to this sort of structure [Ulb90, Ulb91, Moe03, ACJ05, Jur05, GS08, LGSX09, MRS], and not all of these authors use the same terminology (for example the first two papers listed

⁸This can be seen as EA can be constructed so as to be abelian group, whence A is a closed subgroup [Seg70].

call such structures ‘bouquets’ and ‘cocycle bitorsors’ respectively). We shall use a slightly modified version of what appears in [LGSX09], where they are called groupoid G -extensions. Though we shall only treat the case that uses the pretopology \mathcal{O} of open covers (equivalently the associated singleton pretopology $\mathbb{H}\mathcal{O}$), this can be extended to other pretopologies – and indeed ambient categories other than **Top**.

DEFINITION 4.90. The *inertia groupoid* $I(Z)$ of a groupoid Z is the wide subgroupoid (i.e. $I(Z)_0 = Z_0$) with arrows given by the pullback

$$\begin{array}{ccc} I(Z)_1 & \longrightarrow & Z_1 \\ \downarrow & & \downarrow (s,t) \\ Z_0 & \xrightarrow{\Delta} & Z_0 \times Z_0 \end{array}$$

Since the source and target maps are equal, we can consider this to be a bundle of groups over Z_0 .

DEFINITION 4.91. [LGSX09] Let K be a topological group. A K -*bundle gerbe* (or simply *bundle gerbe*) on a space X is a groupoid G with a functor $G \rightarrow X$ such that the maps $G_0 \rightarrow X$ and $G_1 \rightarrow G_0 \times_X G_0$ admit local sections and the inertia groupoid $I(G) \hookrightarrow G$ is a locally trivial bundle of groups with fibres isomorphic to K .

It is a simple consequence of the definition that the fibres of $G \rightarrow X$ are transitive groupoids. We do not assume that K is an abelian group, but it remains to be seen whether there are many examples with K nonabelian (the paper [MRS] makes a study of existence of nonabelian bundle gerbes).

EXAMPLE 4.92. Any A -bundle gerbe E for an abelian topological group A in the sense of definition 4.84 is an A -bundle gerbe in the above sense, with $I(E) \simeq Y \times A$.

LEMMA 4.93. *Let $Z \rightarrow X$ be a 2-covering space. Then $I(Z)$ is a locally trivial bundle of groups.*

Proof. Since $Z_1 \rightarrow Z_0 \times_X Z_0$ is a covering space, the pullback

$$\begin{array}{ccc} I(Z)_1 & \longrightarrow & Z_1 \\ \downarrow & & \downarrow \\ Z_0 & \xrightarrow{\Delta} & Z_0 \times_X Z_0 \end{array}$$

is a covering space, and as such is locally trivial. □

PROPOSITION 4.94. *Let X be path connected, $Z \rightarrow X$ be a 2-covering space with transitive fibres, and define $K = Z(z, z)$ for some point $z \in Z$. Then Z is a K -bundle gerbe.*

Proof. First, $Z_0 \rightarrow X$ admits local sections by lemma 4.54. Since the fibres are transitive, all objects in the fibre containing z have automorphism group isomorphic to K . Since X is path connected, the fibres are all weakly equivalent, so all objects w of Z have $Z(w, w) \simeq K$. Thus $I(Z)$, which is locally trivial by lemma 4.93 has fibres all isomorphic to K . Finally, we know that $Z_1 \rightarrow Z_0 \times_X Z_0$ admits local sections, by proposition 4.59, hence Z satisfies the conditions of definition 4.91. \square

REMARK 4.95. In Giraud’s original approach to gerbes [Gir71], there was a piece of data called the *band* (*lien* in the original french) which was a sheaf of groups, where the stalks were linked by outer isomorphisms. This played a rôle in [Gir71] analogous to the structure group of a principal bundle, although this point of view has since been superseded, with (sheaves of) crossed modules or 2-groups as the coefficients of the cohomology theory classifying gerbes/2-bundles [Deb77, Ald07, AN09]. For the bundle gerbe as described in the proposition, the bundle of groups $I(Z)$ is analogous to the band.

In recent years, the concept of gerbe has been supplemented by that of a 2-bundle [Bar06, BS07] (or categorical torsor [CG01], or bigroupoid 2-torsor [Bak07] – various nomenclature has arisen fairly independently). In this case the fibres are no longer transitive groupoids, but general (internal) groupoids. In terms of definition 4.91, this means that $G_1 \rightarrow G_0 \times_X G_0$ is no longer surjective. In light of the properties of 2-covering spaces, it is reasonable to demand/expect that this map still admits local sections over its image, an open set of $G_0 \times_X G_0$.

We should remark, though, that in light of proposition 4.57, that every 2-covering space $Z \rightarrow X$ is a bundle gerbe over Z_0/Z_1 , which is a covering space of X . This ties in nicely with the following quote from Grothendieck [Gro75]:

Comparer à la remarque de Giraud qu’un (1)-champ en groupoïdes sur X peut s’identifier au couple d’un faisceau π_0 sur X , et d’une (1)-gerbe sur le topos induit X/π_0 (dont le lien, comme de juste, devrait être noté π_1 !).

By removing the transitivity of the fibre, much more possibility for nonabelian phenomena are available, as there are two adjacent dimensions of homotopical information involved (i.e. π_0 and π_1 of the fibre), instead of just one (i.e. π_1 in the case of transitive fibres). Indeed, it is the opinion of Ronnie Brown and the Bangor school of algebraic homotopy that the nonabelianness in algebraic models of homotopy types arises largely from the interaction of the bottom, nonabelian, dimension with the higher ones.

We shall see in the next chapter that there are plenty of natural examples of 2-covering spaces which have ‘nonabelian’ (i.e. non-symmetric) structure 2-groups, but when the fibre is transitive, these 2-groups are necessarily abelian. What this means for more general 2-bundles is not clear.

2-covering spaces II: Examples

In this final chapter we construct a canonical 2-connected 2-covering space for any space that is sufficiently locally well-behaved. This requires some topology, specifically the detailed construction of basic open neighbourhoods of certain path and loop spaces, which we cover in the first section. Given these neighbourhoods, we can then describe a topology on the fundamental bigroupoid of a space as defined in [HKK01, Ste00], for which all the maps describing the bigroupoid structure are continuous under a mild condition on the space.

Given the said condition, which is a two-dimensional analogue of the condition for the existence of a universal covering space, the topological fundamental bigroupoid gives rise to a canonical functorial 2-connected groupoid over the original space. Unfortunately, unless we ask for a more stringent condition to hold – local contractibility – this is not a 2-covering space. This is due to the inequivalence of the pretopology \mathcal{O} with the larger pretopology of open surjections on general spaces, but we do not consider this in detail here. Given local contractibility of the base space, we construct a local trivialisation of the canonical 2-connected cover, thus showing it is a 2-covering space. To wrap up the chapter, we consider an example of a different sort, namely one derived from an ordinary locally trivial bundle by taking the fundamental groupoid of each fibre, topologising these in the usual manner (recalled here for reference) and patching them together.

1. Some topology on mapping spaces

First, we recast some facts about the compact-open topology on the path space X^I into a slightly different form. Recall the definition of an open neighbourhood basis for a topology ([Bro06], definition 5.6.1, conditions a), b) and c'), for example).

DEFINITION 5.1. Let S be a set and for each $s \in S$ let $\{N_s(\lambda)\}_{\lambda \in \Lambda_s}$ be a collection of subsets of S . The collection $\{\{N_s(\lambda)\}_{\lambda \in \Lambda_s} \mid s \in S\}$ is said to be a *basis of open neighbourhoods*, or *open neighbourhood basis*, for a topology on S if

- (1) For all $\lambda \in \Lambda_s$, $s \in N_s(\lambda)$
- (2) For all pairs $\lambda, \nu \in \Lambda_s$, there is a $\mu \in \Lambda_s$ such that $N_s(\mu) \subset N_s(\lambda) \cap N_s(\nu)$
- (3) For all $\lambda \in \Lambda_s$ and all $s' \in N_s(\lambda)$, $N_s(\lambda) = N_{s'}(\lambda')$ for some $\lambda' \in \Lambda_{s'}$.

The sets $N_s(\lambda)$ are called *basic open neighbourhoods*.

There is then a topology \mathcal{T} on S where the open sets are defined to be those sets that contain a basic open neighbourhood of each of their points. In this case, we can talk about an open neighbourhood basis for the topological space (S, \mathcal{T}) .

EXAMPLE 5.2. Consider the space \mathbb{R}^n (with the usual topology). The sets (v, C) where $C \ni v$ is a convex open subset of \mathbb{R}^n , form an open neighbourhood basis.

A non-example of an open neighbourhood basis for \mathbb{R}^n (perhaps to the detriment of the nomenclature) is the collection of open neighbourhoods $(v, B(v, r))$ with $B(v, r)$ an open ball of radius r centred at v .

It is sometimes very useful to know when a subset of the basic open neighbourhoods also forms an open neighbourhood basis. First note that the sets $\{N_s(\lambda)\}_{\lambda \in \Lambda_s}$ are partially ordered by inclusions. The following lemma is an easy exercise.

LEMMA 5.3. *If $\{\{N_s(\lambda)\}_{\lambda \in \Lambda_s} \mid s \in S\}$ is an open neighbourhood basis for a topology \mathcal{T} , and*

$$\{N_s(\lambda_\mu)\} \subset \{N_s(\lambda)\}_{\lambda \in \Lambda_s}$$

is a cofinal subset for each $s \in S$ ($\lambda_\mu \in \Lambda'_s \subset \Lambda_s$) such that $\{\{N_s(\lambda_\mu)\}_{\lambda_\mu \in \Lambda'_s} \mid s \in S\}$ is an open neighbourhood basis for a topology \mathcal{T}' , then $\mathcal{T} = \mathcal{T}'$.

The open neighbourhood basis $\{\{N_s(\lambda_\mu)\}_{\lambda_\mu \in \Lambda'_s} \mid s \in S\}$ is said to be *finer* than the open neighbourhood basis $\{\{N_s(\lambda)\}_{\lambda \in \Lambda_s} \mid s \in S\}$.

EXAMPLE 5.4. Following on from the previous example, there is a finer basis consisting of the basic open neighbourhoods (v, B) where $B \ni v$ is an open ball in \mathbb{R}^n . The reader is encouraged to follow the simple exercise of verifying the conditions of the definition and lemma for these two examples, as they are a simple analogue of the flow of ideas in the next few definitions and lemmata.

Let $\gamma: I \rightarrow X$ be a path, \mathbf{p} a partition given by $\{t_1, \dots, t_n\}$ and $U = \coprod_{i=0}^n U_i$, a finite collection of open sets of X such that the indicated lift (a functor) exists

$$\begin{array}{ccc} \mathbf{p} & \overset{\tilde{\gamma}}{\dashrightarrow} & \check{C}(U) \\ \downarrow & & \downarrow \\ I & \xrightarrow{\gamma} & X \end{array}$$

with $\tilde{\gamma}([t_i, t_{i+1}]) \subset U_i$ (as usual we let $t_0 = 0$ to ensure this makes sense). If this lift exists, we say $\gamma[\mathbf{p}]$ *lifts through* $\check{C}(U)$.

LEMMA 5.5. *Given a set $N_\gamma(\mathbf{p}, U) \subset X^I$ as described above, and any other path $\eta \in N_\gamma(\mathbf{p}, U)$, we have the equality*

$$N_\gamma(\mathbf{p}, U) = N_\eta(\mathbf{p}, U).$$

Proof. If $\eta' \in N_\eta(\mathbf{p}, U)$, then $\eta'[\mathbf{p}]$ lifts through $\check{C}(U)$. But this is precisely the definition of elements in $N_\gamma(\mathbf{p}, U)$. By symmetry we see that these two basic open neighbourhoods are equal. \square

In the following sequence of definitions of open neighbourhood bases we shall prove after each one that the sets do indeed form an open neighbourhood basis.

DEFINITION 5.6. If X is a space, the *compact-open topology* on the set $C(I, X)$ of paths in X has as basic open neighbourhoods the sets

$$N_\gamma(\mathbf{p}, U) = \{\eta: I \rightarrow X \mid \eta[\mathbf{p}] \text{ lifts through } \check{C}(U)\}$$

where U is some finite collection of open sets such that $\gamma[\mathbf{p}]$ lifts through $\check{C}(U)$. The set of paths with this topology will be denoted X^I .

Proof. (That these sets form an open neighbourhood basis)

The conditions (1) and (3) from definition 5.1 are manifest, the latter using lemma 5.5. For the condition (2), let $N_\gamma(\mathbf{p}, U)$ and $N_\gamma(\mathbf{q}, U')$ be basic open neighbourhoods. Consider, for fixed $\gamma \in C(I, X)$, the assignment

$$(\mathbf{p}, U) \xrightarrow{\nu} N_\gamma(\mathbf{p}, U).$$

If \mathbf{p} and U don't satisfy the conditions in the definition of $N_\gamma(\mathbf{p}, U)$, then put $\nu(\mathbf{p}, U) = \emptyset$, the empty subset of $C(I, X)$. This gives us a map

$$\nu: \{(\mathbf{p}, U)\} \rightarrow \mathcal{P}C(I, X)$$

to the power set of $C(I, X)$, which we claim is not injective (away from \emptyset , where it is obviously not injective).

Let \mathbf{p} be given by $\{t_1, \dots, t_n\}$, and for a refinement $\mathbf{p}' \rightarrow \mathbf{p}$ let m_i be the number of regions of \mathbf{p}' that are mapped to $[t_i, t_{i+1}] \subset \mathbf{p}$. Then given $U = \coprod_{i=1}^n U_i$ such that $\nu(\mathbf{p}, U)$ is not empty, define

$$U_{\underline{m}} = \prod_{i=1}^n \prod_{j=1}^{m_i} U_i,$$

whereupon the path $\gamma[\mathbf{p}']$ lifts through $\check{C}(U_{\underline{m}})$. In fact we have the equality

$$N_\gamma(\mathbf{p}', U_{\underline{m}}) = N_\gamma(\mathbf{p}, U),$$

as a simple pasting argument shows, and hence ν is not injective. Thus if we are given a common refinement \mathbf{pq} and sets $N_\gamma(\mathbf{p}, U)$, $N_\gamma(\mathbf{q}, U')$ we can find $U_{\underline{m}}$ and $U'_{\underline{l}}$ such that

$$N_\gamma(\mathbf{p}, U) = N_\gamma(\mathbf{pq}, U_{\underline{m}}) \quad \text{and} \quad N_\gamma(\mathbf{q}, U') = N_\gamma(\mathbf{pq}, U'_{\underline{l}}).$$

In this case the number of open sets making up $U_{\underline{m}}$ and $U'_{\underline{l}}$ are the same, so they can be paired off as $(U_{\underline{m}})_i \cap (U'_{\underline{l}})_i$, unlike the open sets comprising U and U' .

Then, considering $N_\gamma(\mathbf{p}, U) \cap N_\gamma(\mathbf{q}, U') = N_\gamma(\mathbf{pq}, U_{\underline{m}}) \cap N_\gamma(\mathbf{pq}, U'_{\underline{l}})$, define $V_i = (U_{\underline{m}})_i \cap (U'_{\underline{l}})_i$ for all i , and $V = \coprod_i V_i$. There are obvious functors $\check{C}(V) \rightarrow \check{C}(U_{\underline{m}})$ and $\check{C}(V) \rightarrow \check{C}(U'_{\underline{l}})$.

Since $\gamma[\mathbf{pq}]$ lifts through both $\check{C}(U_{\underline{m}})$ and $\check{C}(U'_{\underline{l}})$, it can be seen to lift through $\check{C}(V)$. We can thus consider the set $N_\gamma(\mathbf{pq}, V)$. Any path η in X such that $\eta[\mathbf{pq}]$ lifts through $\check{C}(V)$ also lifts through $\check{C}(U_{\underline{m}})$ and $\check{C}(U'_{\underline{l}})$, so $\eta \in N_\gamma(\mathbf{pq}, U) \cap N_\gamma(\mathbf{pq}, U')$. Thus

$$N_\gamma(\mathbf{pq}, V) \subset N_\gamma(\mathbf{pq}, U) \cap N_\gamma(\mathbf{pq}, U') = N_\gamma(\mathbf{p}, U) \cap N_\gamma(\mathbf{q}, U')$$

as needed. □

REMARK 5.7. Ordinarily, the compact-open topology on a mapping space is defined using a subbasis, but I is compact, and the given basic open neighbourhoods are cofinal in those given by finite intersections of subbasic neighbourhoods, and so define the same topology.

When the finite collection U of open sets is replaced by a finite collection of *basic* open neighbourhoods we find that this still defines an open neighbourhood basis for the compact-open topology.

LEMMA 5.8. *The sets*

$$N_\gamma(\mathbf{p}, W) = \{\eta: I \rightarrow X \mid \eta[\mathbf{p}] \text{ lifts through } \check{C}(W)\},$$

where W is a finite collection of basic open neighbourhoods of X such that $\gamma[\mathbf{p}]$ lifts through $\check{C}(W)$, is a basis of open neighbourhoods for X^I .

Proof. The proof that this is indeed a basis of neighbourhoods and is a basis of neighbourhoods for X^I will proceed in tandem. Clearly basic open neighbourhoods of this sort are also basic open neighbourhoods of the sort given in definition 5.6. As with the treatment of the first basis for compact-open topology, conditions (1) and (3) in definition 5.1 are easily seen to hold, again using lemma 5.5. To show that condition (2) holds, we define the set $N_\gamma(\mathbf{p}, V) \subset N_\gamma(\mathbf{p}, W) \cap N_\gamma(\mathbf{q}, W')$ as in the previous proof. This is a basic open neighbourhood for the compact-open topology as in definition 5.6. Now if we show that any such basic open neighbourhood contains a basic open neighbourhood $N_\gamma(\mathbf{p}, W'')$ as defined in the lemma, we have both shown that sets of this form comprise an open neighbourhood basis, and that they are cofinal in basic open neighbourhoods of the form $N_\gamma(\mathbf{p}, U)$.

Consider then a basic open neighbourhood $N_\gamma(\mathbf{p}, U)$ as in definition 5.6. The open sets U_i in the collection U are a union of basic open neighbourhoods (see e.g. [Bro06], 5.6.2), $U_i = \bigcup_{\alpha \in J_i} W_i^\alpha$. Pull the cover

$$\prod_{i=0}^n \prod_{\alpha \in J_i} W_i^\alpha \rightarrow X$$

back along γ and choose a finite subcover $\prod_{i=0}^n \prod_{\alpha=1}^{k_i} \gamma^* W_i^\alpha$. Denote by $W = \prod_{i,\alpha} W_i^\alpha$ the corresponding collection of $k_0 + k_1 + \dots + k_n$ basic open neighbourhoods of X . This clearly covers the image of γ . Choose a refinement $\mathbf{p}' \rightarrow \mathbf{p}$ such that $\gamma[\mathbf{p}']$ lifts through $\check{C}(W)$.

If $\eta \in N_\gamma(\mathbf{p}', W)$, $\eta[\mathbf{p}']$ lifts through $\check{C}(W)$ and hence through $\check{C}(U)$. To show that $\eta \in N_\gamma(\mathbf{p}, U)$ we just need to show that $\eta[\mathbf{p}'] \rightarrow \check{C}(U)$ factors through \mathbf{p} :

$$\begin{array}{ccc} \mathbf{p}' & \longrightarrow & \check{C}(W) \\ \downarrow & \searrow & \downarrow (*) \\ \mathbf{p} & \dashrightarrow & \check{C}(U) \\ \downarrow & & \downarrow \\ I & \xrightarrow{\eta} & X \end{array}$$

Let (t_i^-, t_i^+) be an arrow in \mathbf{p}' which maps to an identity arrow in \mathbf{p} . We need to show that (t_i^-, t_i^+) is mapped to an identity arrow in $\check{C}(U)$, which would imply the diagonal arrow in the above diagram factors through \mathbf{p} .

Let $\check{C}(W)_i \rightarrow U_i$ be the pullback of the map $(*)$ along $\text{disc}(U_i) \rightarrow \check{C}(U)$. If $[t_i, t_{i+1}]$ is a region of \mathbf{p} and $\mathbf{p}'(i) = [t_i, t_{i+1}] \times_{\mathbf{p}} \mathbf{p}'$, then $\mathbf{p}'(i) \rightarrow \check{C}(U)$ lands in $\text{disc}(U_i)$ and so descends to $[t_i, t_{i+1}]$. Repeating this argument for each i gives the required result. We then apply lemma 5.3 and so the sets $N_\gamma(\mathbf{p}, W)$ form an open neighbourhood basis for the compact-open topology. \square

We shall define special open sets $N_\gamma^*(\mathbf{p}, W)$ which are just basic open neighbourhoods $N_\gamma(\mathbf{p}, W)$ where $W = \coprod_{i=0}^{2n} W_i$ such that $W_{2i+1} \subset W_{2i} \cap W_{2i+2}$ for $i = 0, \dots, n-1$.

LEMMA 5.9. *For every basic open neighbourhood $N_\gamma(\mathbf{p}, W)$ there is an open neighbourhood $N_\gamma^*(\mathbf{p}', W^*) \subset N_\gamma(\mathbf{p}, W)$.*

Proof. If $W = \coprod_{i=0}^n W_i$ and \mathbf{p} is given by $\{t_1, \dots, t_n\}$, define $W_{2i}^* = W_i$ for each $i = 0, \dots, n$, and choose a basic open neighbourhood $W_{2i+1}^* \subset W_i \cap W_{i+1} = W_{2i}^* \cap W_{2i+2}^*$ of $\gamma(t_i)$. Let $W^* := \coprod_{i=0}^{2n} W_i^*$. Then for $i = 1, \dots, n$, choose an $\varepsilon_i > 0$ such that $\gamma([t_i, t_i + \varepsilon_i]) \subset W_{2i+1}^*$ and $t_i + \varepsilon_i < t_{i+1}$. The figure gives a schematic picture of this construction for $n = 3$:

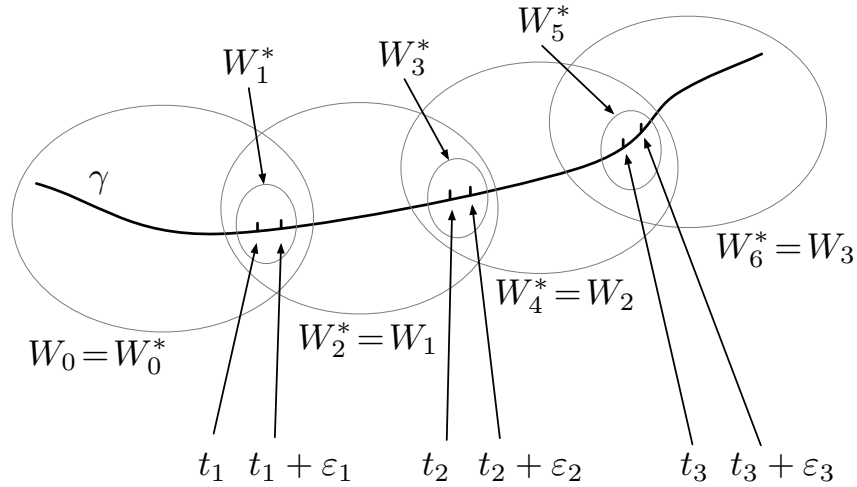

Let \mathbf{p}' be given by $\{t_1, t_1 + \varepsilon_1, \dots, t_n, t_n + \varepsilon_n\}$. Then $\gamma[\mathbf{p}']$ lifts through $\check{C}(W^*)$, so we can consider the basic open neighbourhood $N_\gamma^*(\mathbf{p}', W^*)$. Applying the argument from the end of the proof of lemma 5.8 we can see that any element η of $N_\gamma^*(\mathbf{p}', W^*)$ is such that $\eta[\mathbf{p}']$, which lifts through $\check{C}(W^*)$ and hence $\check{C}(W)$, descends to a functor $\eta[\mathbf{p}] \rightarrow \check{C}(W)$, and so is an element of $N_\gamma(\mathbf{p}, W)$. \square

Given a pair of basic open neighbourhoods W_i, W_{i+1} as per the definition of $N_\gamma^*(\mathbf{p}, W)$, we know that either $W_i \cap W_{i+1} = W_i$ or $W_i \cap W_{i+1} = W_{i+1}$. Thus each intersection $W_i \cap W_{i+1}$ for $i = 0, \dots, n-1$ is a basic open neighbourhood.

PROPOSITION 5.10. *The open sets $N_\gamma^*(\mathfrak{p}, W)$ form an open neighbourhood basis for the compact-open topology on X^I*

Proof. As in the previous two proofs, the sets $N_\gamma^*(\mathfrak{p}, W)$ easily satisfy conditions (1) and (3) of definition 5.1. The intersection $N_\gamma^*(\mathfrak{p}, W) \cap N_\gamma^*(\mathfrak{p}', W')$ contains an open set of the form $N_\gamma(\mathfrak{p}, U)$, and by lemma 5.8 it contains an open set $N_\gamma(\mathfrak{p}, W'')$. Using lemma 5.9, there is a subset of $N_\gamma(\mathfrak{p}, W'')$ of the form $N_\gamma^*(\mathfrak{p}, W''')$. Thus we see that the given open sets satisfies condition (2) of definition 5.1, and are cofinal in the basic open neighbourhoods from lemma 5.8. Hence they form an open neighbourhood basis for X^I . \square

In light of this result we can use any of these open neighbourhood bases when dealing with the compact-open topology. We can then transfer the topological properties of X described in terms of basic open neighbourhoods to the topological properties of X^I , and various subspaces, described in terms of basic open neighbourhoods. The reason we want to do this is that there seems to be a rough correspondence between categorified structures (e.g. 2-bundles) on X and ordinary structures (e.g. bundles) on spaces of loops. This has not been made precise, but is reflected in various places like Schreiber's work on categorified gauge theory [Sch05] relating to quantum mechanics on loop spaces, Witten's Dirac-Ramond operator [Wit88], and more classically in certain transgression maps in cohomology. This latter can be seen in modern interpretations of cohomology $H^n(X, A)$ as being the set of connected components of a higher-categorical version of cohomology.

We recall from chapter 4 the definition of an n -well-connected space

DEFINITION 5.11. Let n be a positive integer. A space X is called *n -well-connected* if it has a basis of $(n - 1)$ -connected open neighbourhoods N_λ such that $\pi_n(N_\lambda) \rightarrow \pi_n(X)$ is the trivial map (for any choice of basepoint). We say a space is *0-well-connected* if for any basic neighbourhood N_λ and any two points $x, y \in N_\lambda$, there is a path from x to y in X .

Let $P_{x_0, x_1}X$ be the fibre of $(ev_0, ev_1): X^I \rightarrow X \times X$ over (x_0, x_1) . Notice that the based loop space $\Omega_x X$ at a point x is $P_{x, x}X$. We shall denote by $P_x X$ the space of paths based at x , i.e. the fibre of $ev_0: X^I \rightarrow X$ at x . The space of free loops $LX = X^{S^1}$ (given the compact-open topology) can be identified with the inverse image $(ev_0, ev_1)^{-1}(X)$ of the diagonal $X \hookrightarrow X \times X$. If there is no confusion, we will usually denote the based loop space simply by ΩX .

The following theorem is more general than we need, but is of independent interest. Although a more general theorem is stated in [Wad55], the proof is only implied from the case that is proved, namely when X is locally n -connected. That proof is intended for an analogous result for the local properties of the mapping space X^P for P any finite polyhedron, and for various subspaces thereof. As a result, the proof has to deal with the fact P is not ordered as I is, and so is necessarily quite complicated.

THEOREM 5.12. *If a space X is n -well-connected, $n \geq 1$, the spaces X^I , $P_x X$, $P_{x, y}X$ and $\Omega_x X = P_{x, x}X$ are all $(n - 1)$ -well-connected.*

Proof. First of all, assume that X is 1-well-connected, let $\gamma \in X^I$ and $N_\gamma^*(\mathbf{p}, W)$ be a basic neighbourhood where \mathbf{p} is given by $\{t_1, \dots, t_m\}$. Temporarily define $t_0 := 0$ and $t_{m+1} := 1$. Then given two points $\gamma_0, \gamma_1 \in N_\gamma^*(\mathbf{p}, W)$, we know that for each $i = 0, \dots, m+1$, $\gamma_0(t_i), \gamma_1(t_i) \in W_{i-1} \cap W_i$, which is a basic open neighbourhood of X . Let η_i be a path in $W_{i-1} \cap W_i$ from $\gamma_0(t_i)$ to $\gamma_1(t_i)$ for $i = 1, \dots, m$, and let η_0 , be a path from $\gamma_0(0)$ to $\gamma_0(t_0)$ in W_0 and η_{m+1} be a path from $\gamma_0(1)$ to $\gamma_1(1)$ in W_n . The sequence of paths

$$(21) \quad \begin{array}{ccc} & \overline{\eta_i} & \\ & \leftarrow \text{~~~~~} & \\ \gamma_0(t_i) & & \gamma_1(t_i) \\ \downarrow \text{~~~~~} & & \uparrow \text{~~~~~} \\ \gamma_0|_{[t_i, t_{i+1}]} & & \gamma_1|_{[t_i, t_{i+1}]} \\ & \text{~~~~~} & \\ & \eta_{i+1} & \\ & \leftarrow \text{~~~~~} & \\ & \gamma_0(t_{i+1}) & \gamma_1(t_{i+1}) \end{array}$$

then defines a loop in W_i for $i = 1, \dots, m-1$. As X is 1-well-connected, there is a surface in X of which this loop is the boundary.

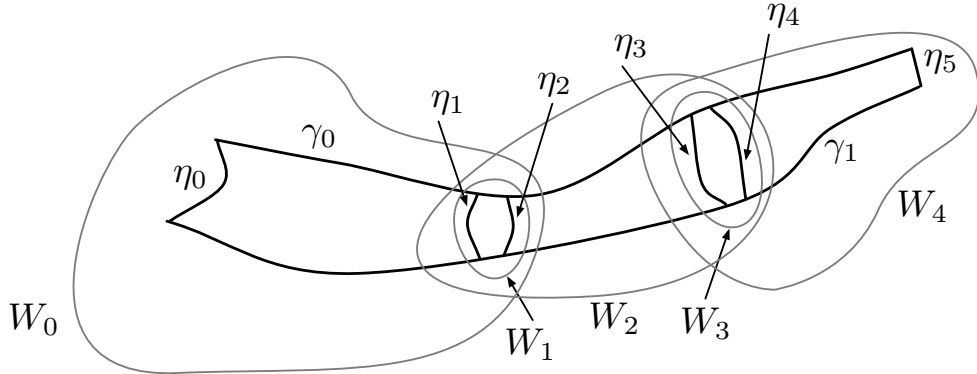

These surfaces patch together to form a free homotopy in X between the *paths* γ_0 and γ_1 . By adjointness, this defines a path in X^I between the *points* γ_0 and γ_1 . Thus X^I is 0-well-connected.

If we consider the subspace $P_x X$ (resp. $P_{x,y} X$), then we take the path η_0 (resp. the paths η_0 and η_{m+1}) to be constant. This implies that the path in X^I defined in the previous paragraph lands in $P_x X$ (resp. $P_{x,y} X$), and so those subspaces are likewise 0-well-connected.

Now assume that X is n -well-connected with $n \geq 2$ and that $N_\gamma^*(\mathbf{p}, W)$ is a basic open neighbourhood of the point γ . Consider the k -sphere S^k ($k \geq 0$) to be pointed by the ‘north pole’ N . Let $f: S^k \rightarrow X^I$ be a map in $N_\gamma^*(\mathbf{p}, W)$ such that at $f(N) = \gamma$. By adjointness, this determines a map $\tilde{f}: S^k \times I \rightarrow X$ such that the restriction $\tilde{f}|_{S^k \times [t_i, t_{i+1}]}$ factors through W_i for $i = 0, \dots, m$. Note that if we further restrict this map to $\tilde{f}|_{S^k \times \{t_i\}}$ then for $i = 1, \dots, m$ it factors through $W_{i-1} \cap W_i$, which is a basic open neighbourhood by the assumption on W . We also have maps $\tilde{f}|_{S^k \times \{0\}}$, landing in W_0 , and $\tilde{f}|_{S^k \times \{1\}}$, landing in W_m . The assumption

on X implies that the basic open neighbourhoods are $(n - 1)$ -connected, so that for $k = 0, \dots, m - 1$, there are maps $\eta_i: B^{k+1} \rightarrow W_{i-1} \cap W_i$, for $i = 1, \dots, m$ $\eta_0: B^{k+1} \rightarrow W_0$ and $\eta_{m+1}: B^{k+1} \rightarrow W_m$ filling these spheres.

Now for $k = 0, \dots, n - 1$ and $i = 0, \dots, m - 1$ the maps η_i define, together with the cylinders $\tilde{f}|_{S^k \times [t_i, t_{i+1}]}$, maps ξ_i from a (space homeomorphic to a) $k + 1$ -sphere to W_i . As W_i is $(n - 1)$ -connected, for $k = 0, \dots, n - 2$ and $i = 0, \dots, m$ there is a map $v_i: B^{k+1} \times [t_i, t_{i+1}] \rightarrow W_i$ filling the sphere. The $m + 1$ maps v_i paste together to form a homotopy $B^{k+1} \times I \rightarrow X$ and a map $B^{k+1} \rightarrow N_\gamma^*(\mathbf{p}, W)$ filling the map from the sphere we started with. Thus the basic open neighbourhood $N_\gamma^*(\mathbf{p}, W)$ is $(n - 2)$ -connected.

If we now take $k = n - 1$, then we can find maps $v_i: B^n \times [t_i, t_{i+1}] \rightarrow X$ filling the sphere. These paste together to give a homotopy $B^n \times I \rightarrow X$ and so a map $B^n \rightarrow X^I$ filling the sphere $S^{n-1} \rightarrow N_\gamma^*(\mathbf{p}, W) \hookrightarrow X^I$. This implies that the map $\pi_{n-1}(N_\gamma^*(\mathbf{p}, W), \gamma) \rightarrow \pi_{n-1}(X^I)$ is trivial, and so X^I is $(n - 1)$ -well-connected.

If we again consider the subspaces $P_x X$ and $P_{x,y} X$, we can choose the maps η_0 and η_m to be constant (where appropriate) and so this ensures the maps $B^{k+1} \rightarrow X^I$ constructed above factor through the relevant subspace. \square

As a corollary we get a much simpler proof of another special case of the theorem from [Wad55], namely for the mapping space X^{S^m} , or more specifically the subspace of based maps. Let $N \in S^m$ be the 'north pole'.

COROLLARY 5.13. *If X is n -well-connected and $m \leq n$, the space $(X, x)^{(S^m, N)}$ of pointed maps is $(n - m)$ -well-connected.*

Proof. This is an easy induction on m using theorem 5.12, using $X^{S^m} = \Omega^m X$, the m -fold based loop space. \square

We can also discuss the local homotopical properties of the space LX , as long as we make one further refinement to the neighbourhood basis it inherits from X^I . Let $N_\gamma^o(\mathbf{p}, W)$ denote an open neighbourhood $N_\gamma(\mathbf{p}, W)$ of LX with $W = \coprod_{i=0}^{2n+1} W_i$ where for $i = 1, \dots, n - 1$, we have $W_{2i+1} \subset W_{2i} \cap W_{2i+2}$ and $W_{2n+1} \subset W_{2n} \cap W_0$. The proofs of the following lemma and proposition are almost identical to that of lemma 5.9 and proposition 5.10, so we omit them.

LEMMA 5.14. *For every basic open neighbourhood $N_\gamma(\mathbf{p}, W)$ of LX , there is a basic open neighbourhood of the form $N_\gamma^o(\mathbf{p}', W')$ contained in $N_\gamma(\mathbf{p}, W)$.*

PROPOSITION 5.15. *The sets $N_\gamma^o(\mathbf{p}, W)$ form an open neighbourhood basis for the compact-open topology on LX .*

We then have the following analogue of theorem 5.12.

THEOREM 5.16. *If the space X be n -well-connected, the space LX is $(n - 1)$ -well-connected.*

Proof. Assume that the point $\gamma \in LX$ has a basic neighbourhood $N_\gamma^o(\mathbf{p}, W)$ where $W = \coprod_{i=0}^m W_i$. The proof proceeds along the same lines as that of theorem 5.12,

except we let $\eta_0 = \eta_{m+1}: B^{k+1} \rightarrow W_m \cap W_0$. This is enough to ensure that the rest of the proof goes through and that for $k = 0, \dots, n-2$ we have maps $B^{k+1} \rightarrow N_\gamma^o(\mathbf{p}, W)$ expressing the k -connectedness of $N_\gamma^o(\mathbf{p}, W)$, and maps $B^n \rightarrow LX$ that give us the result that $\pi_{n-1}(N_\gamma^o(\mathbf{p}, W)) \rightarrow \pi_{n-1}(LX)$ is the trivial homomorphism. \square

The following corollary of theorems 5.12 and 5.12 is the main point of this section, and we shall use it to construct a 2-connected 2-covering space.

COROLLARY 5.17. *If X is 2-well-connected, the components of LX and ΩX admit 1-connected covering spaces.*

In particular, the space L_0X of null-homotopic free loops – loops that bound a disk in X – admits a covering space $(L_0X)^{(1)}$ with 1-connected components such that $\pi_0((L_0X)^{(1)}) \rightarrow \pi_0(L_0X)$ is an isomorphism. As usual, such a covering space is unique up to isomorphism of spaces in the slice category of maps inducing isomorphisms on π_0 (see remark 4.24).

We finish this section by showing that several maps involving paths spaces, induced by operations of paths, are indeed continuous.

LEMMA 5.18. *The concatenation map $\cdot: X^I \times_{ev_0, X, ev_1} X^I \rightarrow X^I$ is continuous.*

Proof. Let $\gamma_1, \gamma_2 \in X^I$ be paths in X , and $N := N_{\gamma_2 \cdot \gamma_1}(\mathbf{p}, W)$ a basic open neighbourhood as given by lemma 5.8. We can assume that \mathbf{p} is given by

$$\{t_1, \dots, t_n, 1/2, t'_1, \dots, t'_m\},$$

else we can refine \mathbf{p} and alter W so that it does without changing N (as specified in the proof following definition 5.6). The collection W of basic open neighbourhoods then looks like

$$W = \prod_{i=0}^n W_i^1 \prod_{j=0}^m W_j^2 =: W^1 \amalg W^2.$$

Define the refinement $\mathbf{p}' \rightarrow \mathbf{p}$ by adding an additional two points $\frac{1}{2} - \epsilon, \frac{1}{2} + \epsilon$ to the specification of \mathbf{p} , where ϵ is small enough that the image of $[\frac{1}{2} - \epsilon, \frac{1}{2} + \epsilon]$ under $\gamma_2 \cdot \gamma_1$ lands in a basic open neighbourhood $W_{n+1} \subset W_n^1 \cap W_0^2$. Then defining

$$W' = \prod_{i=0}^n W_i^1 \amalg W_{n+1} \amalg W_{n+1} \prod_{j=0}^m W_j^2 =: W^1 \amalg W^2,$$

we see that $(\gamma_2 \cdot \gamma_1)[\mathbf{p}]$ lifts through W' . There is then a subset

$$N' := N_{\gamma_2 \cdot \gamma_1}(\mathbf{p}', W') \subset N_{\gamma_2 \cdot \gamma_1}(\mathbf{p}, W)$$

We now set $N_1 = N_{\gamma_1}(\mathbf{p}_1, W^1 \amalg W_{n+1})$, $N_2 = N_{\gamma_2}(\mathbf{p}_2, W_{n+1} \amalg W^2)$ where \mathbf{p}_1 is given by $\{2t_1, \dots, 2t_n, 1 - 2\epsilon\}$ and \mathbf{p}_2 is given by $\{2\epsilon, 2t'_1 - 1, \dots, 2t'_m - 1\}$. Thus \mathbf{p}' is the concatenation $\mathbf{p}_1 \vee_t \mathbf{p}_2$.

The fibred product $N_2 \times_X N_1$ consists of pairs of paths η_1, η_2 that lift through W_1 and W_2 resp., whose endpoints match and in particular, $\eta_1(1) = \eta_2(1) = (\eta_2 \cdot \eta_1)(\frac{1}{2}) \in W_n^1 \cap W_0^2$. Thus $\eta_2 \cdot \eta_1[\mathbf{p}]$ lifts through W , and so the image of $N_2 \times_X N_1$ under concatenation is contained in N , so concatenation is continuous. \square

LEMMA 5.19. *The map $X \rightarrow X^I$ sending a point x to the constant path \underline{x} is continuous.*

Proof. Let $N = N_{\underline{x}}(\mathfrak{p}, W)$ be a basic open neighbourhood. The collection W is a finite set of basic neighbourhoods of x , so take the intersection $W_0 \cap \dots \cap W_n$ and let W' be a basic open neighbourhood contained in that intersection. For all $x' \in W'$, $\underline{x}'[\mathfrak{p}]$ clearly lifts through W , so the image of W' under $X \rightarrow X^I$ is contained in N . \square

The following easy lemma is left as a final exercise for the reader.

LEMMA 5.20. *The ‘reverse’ map $X^I \rightarrow X^I$ sending a path γ to the same path traversed in the opposite direction is continuous.*

2. The topological fundamental bigroupoid of a space

One can put a topology on the fundamental groupoid of a space X if it is 1-well-connected. In this section we shall generalise this to the fundamental bigroupoid from [Ste00, HKK01] described in chapter 4. It requires local conditions on the free loop space LX , which as we saw in the previous section, can be phrased in terms of the topology of X . We shall also describe the necessary conditions algebraically using the fundamental bigroupoid.

We shall first treat the case of the fundamental groupoid, as we shall need it again in the second part of this section. Assume the space X is 1-well-connected. Since the set of objects of $\Pi_1(X)$ is just X^δ , we just give it the topology from X . Now recall that the set $\Pi_1(X)_1$ is the set of paths $C(I, X)$ in X quotiented by the equivalence relation ‘homotopic rel endpoints’. Let x, y be points in X , and without loss of generality we can assume they are in the same path-component. Let W_x and W_y be basic open neighbourhoods of x and y respectively. Notice that they are path-connected by assumption, and the homomorphisms $\pi_1(W_x, x) \rightarrow \pi_1(X, x)$, $\pi_1(W_y, y) \rightarrow \pi_1(X, y)$ are trivial.

For $[\gamma]$ a homotopy class of paths from x to y , we now describe an open neighbourhood basis for $\Pi_1(X)_1$. Define the sets

$$N_{[\gamma]}(W_x, W_y) = \{[\eta_x \cdot \gamma \cdot \eta_y] \in \Pi_1(X)_1 \mid \eta_\? : I \rightarrow W_\?, \? = x, y, \eta_x(1) = \gamma(0), \eta_y(0) = \gamma(1)\}$$

where the operation $- \cdot -$ is the usual concatenation of paths, with the first path on the right and the second on the left. Note that these are homotopy classes in X , as opposed to taking homotopies of paths of the form $\eta_x \cdot \gamma \cdot \eta_y$.

PROPOSITION 5.21. *The sets $N_{[\gamma]}(W_x, W_y)$ form an open neighbourhood basis for $\Pi_1(X)_1$.*

Proof. We have $\gamma \in N_{[\gamma]}(W_x, W_y)$ by definition, condition (1) from definition 5.1 holds. If $[\omega] \in N_{[\gamma]}(W_x, W_y)$, then for all $[\omega'] \in N_{[\gamma]}(W_x, W_y)$ we can write

$$\begin{aligned} [\omega'] &= [\eta'_x \cdot \gamma \cdot \eta'_y] \\ &= [\eta'_x \cdot \overline{\eta_x} \cdot \eta_x \cdot \gamma \cdot \eta_y \cdot \overline{\eta_y} \cdot \eta'_y] \\ &= [\eta'_x \cdot \omega \cdot \eta'_y] \end{aligned}$$

where $[\omega] = [\eta_x \cdot \gamma \cdot \eta_y]$. Thus $N_{[\gamma]}(W_x, W_y) \subset N_{[\omega]}(W_x, W_y)$. Since $[\gamma] = [\overline{\eta_x} \cdot \omega \cdot \overline{\eta_y}] \in N_{[\omega]}(W_x, W_y)$ we can use symmetry to show that $N_{[\omega]}(W_x, W_y) \subset N_{[\gamma]}(W_x, W_y)$, and condition (3) in definition 5.1 is satisfied.

To show that condition (2) is satisfied, let $N_{[\gamma]}(W_x, W_y), N_{[\gamma]}(W'_x, W'_y)$ be a pair of putative basic neighbourhoods of $[\gamma]$. Let $W''_x \subset W_x \cap W'_x$ and $W''_y \subset W_y \cap W'_y$ be basic open neighbourhoods of x and y . The set $N_{[\gamma]}(W''_x, W''_y)$ is then contained in $N_{[\gamma]}(W_x, W_y) \cap N_{[\gamma]}(W'_x, W'_y)$. \square

Although we now have topologies on the sets $\Pi_1(X)_0$ and $\Pi_1(X)_1$, we do not know that they form a topological groupoid – composition and other structure maps need to be checked for continuity. This sort of mistake was made in [Bli00] when dealing with the so-called topological fundamental group of a not-necessarily 1-well-connected space, where the multiplication $\pi_1^{top} \times \pi_1^{top} \rightarrow \pi_1^{top}$ turned out to be continuous in each variable, but not jointly continuous (see e.g. [Bra09]). In that case the topology was the identification topology inherited from the compact-open topology on the based loop space. Here we are obviously taking a different tack.

PROPOSITION 5.22. *With the topology as described above, $\Pi_1(X)$ is a topological groupoid for X a 1-well-connected space.*

Proof. We need to check the continuity of four maps, namely

$$\begin{aligned} (s, t): \Pi_1(X)_1 &\rightarrow X \times X, \\ \overline{(-)}: \Pi_1(X)_1 &\rightarrow \Pi_1(X)_1, \\ e: X &\rightarrow \Pi_1(X)_1, \\ m: \Pi_1(X)_1 \times_X \Pi_1(X)_1 &\rightarrow \Pi_1(X)_1 \end{aligned}$$

We shall use the following criterion to check for continuity:

- A map $f: X \rightarrow Y$ between topological spaces is continuous if and only if for every $x \in X$ and basic open neighbourhood N_Y of $f(x)$, there is a basic open neighbourhood N_X of x such that $N_X \subset f^{-1}(N_Y)$ (equivalently, $f(N_X) \subset N_Y$).

Let $[\gamma]$ be a point in $\Pi_1(X)_1$, and set $(x, y) = (s[\gamma], t[\gamma])$. The inverse image

$$(s, t)^{-1}(W_x \times W_y)$$

contains the basic open neighbourhood $N_{[\gamma]}(W_x, W_y)$, so (s, t) is continuous.

Given the basic open neighbourhood $N_{[\gamma]}(W_x, W_y)$, it is simple to check that

$$\overline{(N_{[\gamma]}(W_x, W_y))} = N_{[\gamma]}(W_y, W_x),$$

so $\overline{(-)}$ is continuous.

For $x \in X$, consider the basic open neighbourhood $N_{[\text{id}_x]}(W_x, W'_x)$. The inverse image $e^{-1}(N_{[\text{id}_x]}(W_x, W'_x))$ is the intersection $W_x \cap W'_x$. There is a basic open neighbourhood $W''_x \subset W_x \cap W'_x$, so e is continuous.

It now only remains to show that multiplication in $\Pi_1(X)$ is continuous. For composable arrows $[\gamma_1]: x \rightarrow y$ and $[\gamma_2]: y \rightarrow z$, let $N_{[\gamma_2 \cdot \gamma_1]}(W_x, W_z)$ be a basic open neighbourhood. If W_y is a basic open neighbourhood of y the set $N_{[\gamma_2]}(W_y, W_z) \times_X$

$N_{[\gamma_1]}(W_x, W_y)$ is a basic open neighbourhood of $([\gamma_2], [\gamma_1])$ in $\Pi_1(X)_1 \times_X \Pi_1(X)_1$. Arrows in the image of this set under m look like

$$[\lambda_1 \cdot \gamma_2 \cdot \lambda_0 \cdot \eta_1 \cdot \gamma_1 \cdot \eta_0],$$

where λ_1 is a path in W_z , λ_0 and η_1 are paths in W_y such that $\lambda_0(\epsilon) = \eta_1(\epsilon + 1)$ for $\epsilon = 0, 1 \pmod{2}$ and η_0 is a path in W_x . Now the composite $\lambda_0 \cdot \eta_1$ is a loop in W_y at y . The arrow $[\lambda_0 \cdot \eta_1]$ is equal to id_y in $\Pi_1(X)$ by the assumption that X is 1-well-connected. Thus

$$[\lambda_1 \cdot \gamma_2 \cdot \lambda_0 \cdot \eta_1 \cdot \gamma_1 \cdot \eta_0] = [\lambda_1 \cdot \gamma_2 \cdot \gamma_1 \cdot \eta_0]$$

and we have an inclusion

$$m(N_{[\gamma_2]}(W_y, W_z) \times_X N_{[\gamma_1]}(W_x, W_y)) \subset N_{[\gamma_2 \cdot \gamma_1]}(W_x, W_z).$$

This implies multiplication is continuous. \square

PROPOSITION 5.23. *For a 1-well-connected space X , the topological groupoid $\Pi_1(X)$ is weakly discrete.*

Proof. We will show $\Pi_1(X)_1 \rightarrow X \times X$ is a covering space and then apply proposition 4.40. Let $X = \coprod_{\alpha} X_{\alpha}$ with each X_{α} a connected (path-)component. Clearly the fibres over $X_{\alpha} \times X_{\beta}$ for $\alpha \neq \beta$ are empty, so we can just consider the restriction of $\Pi_1(X)_1$ to each $X_{\alpha} \times X_{\alpha}$, from which it follows we can assume X connected. It is also immediate that the image of (s, t) is open.

Let $(x, y) \in X^2$ and $W_x \times W_y$ be a basic open neighbourhood of (x, y) , this means that W_x, W_y are path-connected and the inclusion maps induce zero maps on fundamental groups. Let $N_{[\gamma]}(W_x, W_y)$ be a basic neighbourhood. The restriction $(s, t)|_{N_{[\gamma]}(W_x, W_y)}$ maps surjectively onto $W_x \times W_y$, using the path-connectedness of W_x and W_y . Consider now the surjective map $s|_{N_{[\gamma]}(W_x, W_y)}: N_{[\gamma]}(W_x, W_y) \rightarrow W_x$. Assume there are two paths η_1, η_2 in $N_{[\gamma]}(W_x, W_y)$ with source $x' \in W_x$ and target $y' \in W_y$. We know that $[\eta_1] = [\omega_1 \cdot \gamma]$ and $[\eta_2] = [\omega_2 \cdot \gamma]$ and so $\overline{\omega_2} \cdot \omega_1$ is a loop in W_y based at y . By the assumption on X , this loop is null-homotopic in X , or in other words, $[\omega_1] = [\omega_2]$ in $\Pi_1(X)_1$, so $[\eta_1] = [\eta_2]$. Using a similar argument for W_x , we get the result that $(s, t)|_{N_{[\gamma]}(W_x, W_y)}$ is a bijection. It is easily seen that (s, t) maps basic open neighbourhoods to basic open neighbourhoods, and so is an open map, hence an isomorphism. The sets $N_{[\gamma]}(W_x, W_y), N_{[\gamma']}(W_x, W_y)$ are disjoint for $[\gamma] \neq [\gamma']$, by arguments from the proof of proposition 5.21. Since every arrow $x' \rightarrow y'$ in $\Pi_1(X)$ for $x' \in W_x$ and $y' \in W_y$ lies in some $N_{[\gamma]}(W_x, W_y)$, we have an isomorphism

$$\Pi_1(X) \times_{X^2} (W_x \times W_y) \simeq (W_x \times W_y) \times \Pi_2(X)(x, y)$$

and so $\Pi_1(X) \rightarrow X \times X$ is a covering space. \square

We then know that for connected, 1-well-connected X ,

$$(\{x\} \times X) \times_{X \times X} \Pi_1(X)_1 = s^{-1}(x) = X^{(1)},$$

i.e. the canonical covering space, actually is a covering space. The basic open neighbourhoods of a point $[\gamma] \in X^{(1)}$ with $s[\gamma] = x$ are

$$N_{[\gamma]}(W) := \{[\eta \cdot \gamma] \in \Pi_1(X)_1 \mid \eta: I \rightarrow W, \eta(0) = \gamma(1)\}.$$

To assist in further proofs of continuity, we give a small lemma.

LEMMA 5.24. *For a 1-well-connected space X , the map $[-]: X^I \rightarrow \Pi_1(X)_1$ is continuous.*

Proof. Let $N_{[\gamma]}(W_x, W_y)$ be a basic open neighbourhood. The inverse image

$$[-]^{-1}N_{[\gamma]}(W_x, W_y)$$

consists of points in the open set $U_{x,y} := (ev_0, ev_1)^{-1}(W_x \times W_y) \subset X^I$ that are connected by a path in $U_{x,y}$ to a point of the form $\eta_x \cdot (\gamma \cdot \eta_y)$. Note that every such point is connected by a path in $U_{x,y}$ to the point γ – this can be seen by constructing a free homotopy connecting the path $\eta_x \cdot (\gamma \cdot \eta_y)$ to the path γ . Now X^I is 0-well-connected by theorem 5.12 we can choose a basic open neighbourhood $N_\gamma^*(\mathbf{p}, W)$ with $W = \coprod_{i=0}^n W_i$ such that $W_0 = W_x$ and W_y . Every point η in this neighbourhood is connected by a path Γ_η in X^I to γ . Moreover, we can choose this path, as in the proof of theorem 5.12, to be such that $ev_0 \circ \Gamma_\eta(t) \in W_x$ and $ev_1 \circ \Gamma_\eta(t) \in W_y$ for all $t \in I$. Thus the neighbourhood $N_\gamma^*(\mathbf{p}, W)$ is a subset of $U_{x,y}$, and m is continuous. \square

Now if we are given a homotopy $Y \times I \rightarrow X$, that is a map $Y \rightarrow X^I$, we get a map $Y \rightarrow \Pi_1(X)_1$ by composition with $[-]$.

To describe the topological fundamental bigroupoid of a space, we first need to define a topological bigroupoid. We assume the reader at this point is familiar with the definition of bigroupoid as recalled in the appendix. The full algebraic (i.e. diagrammatic) definition of a bicategory in a finitely complete category, an internal bicategory in other words, is not new. Indeed, it appeared in the original article on bicategories [Bén67], and a recent treatment is in [Bak07]. Since we are only interested in *topological* bigroupoids – bigroupoids in **Top**, a concrete category – we can refer to elements of objects with impunity. This means that the pointwise coherence diagrams in the appendix are still valid, and we do not need to display three-dimensional commuting diagrams of internal natural transformations.

DEFINITION 5.25. *A topological bigroupoid B is a topological groupoid \underline{B}_1 equipped with a functor $(S, T): \underline{B}_1 \rightarrow \text{disc}(B_0 \times B_0)$ for a space B_0 together with*

- functors

$$\begin{aligned} C: \underline{B}_1 \times_{S, \text{disc}(B_0), T} \underline{B}_1 &\rightarrow \underline{B}_1 \\ I: \text{disc}(B_0) &\rightarrow \underline{B}_1 \end{aligned}$$

over $\text{disc}(B_0 \times B_0)$ and a functor

$$\overline{(-)}: \underline{B}_1 \rightarrow \underline{B}_1$$

covering the swap map $\text{disc}(B_0 \times B_0) \rightarrow \text{disc}(B_0 \times B_0)$.

- continuous maps

$$(22) \quad \begin{cases} a: \text{Obj}(\underline{B}_1) \times_{S,B_0,T} \text{Obj}(\underline{B}_1) \times_{S,B_0,T} \text{Obj}(\underline{B}_1) \rightarrow \text{Mor}(\underline{B}_1) \\ r: \text{Obj}(\underline{B}_1) \rightarrow \text{Mor}(\underline{B}_1) \\ l: \text{Obj}(\underline{B}_1) \rightarrow \text{Mor}(\underline{B}_1) \\ e: \text{Obj}(\underline{B}_1) \rightarrow \text{Mor}(\underline{B}_1) \\ i: \text{Obj}(\underline{B}_1) \rightarrow \text{Mor}(\underline{B}_1) \end{cases}$$

which are the component maps of natural isomorphisms

$$\begin{array}{ccc} \underline{B}_1 \times_{S,\text{disc}(B_0),T} \underline{B}_1 \times_{S,\text{disc}(B_0),T} \underline{B}_1 & \xrightarrow{\text{id} \times C} & \underline{B}_1 \times_{S,\text{disc}(B_0),T} \underline{B}_1 \\ \downarrow C \times \text{id} & & \downarrow C \\ \underline{B}_1 \times_{S,\text{disc}(B_0),T} \underline{B}_1 & \xrightarrow{C} & \underline{B}_1 \end{array} \quad \begin{array}{c} \nearrow a \\ \searrow \end{array}$$

$$\begin{array}{ccccc} \underline{B}_1 \times_{S,\text{disc}(B_0)} \text{disc}(B_0) & \xrightarrow{\text{id} \times I} & \underline{B}_1 \times_{S,\text{disc}(B_0),T} \underline{B}_1 & \xleftarrow{I \times \text{id}} & \text{disc}(B_0) \times_{\text{disc}(B_0),T} \underline{B}_1 \\ & \searrow & \downarrow C & \nearrow & \searrow \\ & \simeq & \underline{B}_1 & \simeq & \\ & \swarrow r & & \swarrow l & \\ & & \underline{B}_1 & & \end{array}$$

$$\begin{array}{ccccc} \underline{B}_1 & \xrightarrow{((-), \text{id})} & \underline{B}_1 \times_{S,\text{disc}(B_0),T} \underline{B}_1 & \xleftarrow{(\text{id}, (-))} & \underline{B}_1 \\ \downarrow s & & \downarrow C & & \downarrow T \\ \text{disc}(B_0) & \xrightarrow{I} & \underline{B}_1 & \xleftarrow{I} & \text{disc}(B_0) \end{array} \quad \begin{array}{c} \nearrow e \\ \searrow i \end{array}$$

These are required to satisfy the usual coherence diagrams as given in definitions A.1 and A.2.

Since the 1-arrows of $\Pi_2^T(X)$ are paths in X , we can let the topology on $\Pi_2^T(X)_1$ be the compact-open topology from the previous section. We also let the topology on the objects of $\Pi_2^T(X)$ be that of X . The object components of the functors S, T , which are evaluation at 0 and 1 respectively, are clearly continuous, as is the map $X \rightarrow X^I$ sending a point to a constant path. All we need to have a candidate for being a topological fundamental bigroupoid is a topology on the set of 2-arrows.

Recall that the composition of 2-tracks $[f], [g]$ along a path (vertical composition) is denoted by $[f+g]$, and the concatenation (horizontal composition) is denoted $[f \cdot g]$.

The inverse of a 2-track $[f]$ for this composition is written $-[f] = [-f]$. If $[f]$ is a 2-track with representative $f: I^2 \rightarrow X$, let $\ulcorner f \urcorner: I \rightarrow X^I$ be the corresponding path.

LEMMA 5.26. *Let $[h] \in \Pi_2^T(X)_2$ be a 2-track, U_0, U_1 basic open neighbourhoods of $s_0[h], t_0[h] \in X$ respectively, and*

$$V_0 = N_{s_1[h]}(\mathfrak{p}_0, \prod_{i=0}^{n_0} W_i^{(0)}) \quad \text{and} \quad V_1 = N_{t_1[h]}(\mathfrak{p}_1, \prod_{i=0}^{n_1} W_i^{(1)})$$

basic open neighbourhoods in X^I . Also assume that

$$U_0 \subset W_0^{(0)} \cap W_0^{(1)}, \quad U_1 \subset W_{n_0}^{(0)} \cap W_{n_1}^{(1)}.$$

Then the sets

$$\langle [h], U_0, U_1, V_0, V_1 \rangle := \{[f] \in \Pi_2^T(X)_2 \mid \exists \beta_\epsilon: I \rightarrow U_\epsilon \ (\epsilon = 0, 1) \text{ and } \ulcorner \lambda_\epsilon \urcorner: I \rightarrow V_\epsilon \ (\epsilon = 0, 1) \\ \text{such that } [f] = [\lambda_1 + (\text{id}_{\beta_1} \cdot (h \cdot \text{id}_{\beta_0})) + \lambda_0]\},$$

form an open neighbourhood basis for $\Pi_2^T(X)_2$.

Proof. Algebraically the elements of the basic open neighbourhoods $\langle [h], U_0, U_1, V_0, V_1 \rangle$ look like diagrams

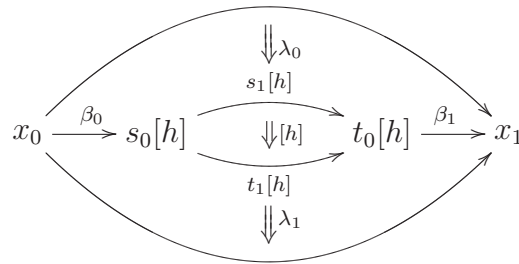

with some hidden bracketing on the whiskering of h by β_0, β_1 . Here is a topological viewpoint of the same element of $\langle [h], U_0, U_1, V_0, V_1 \rangle$:

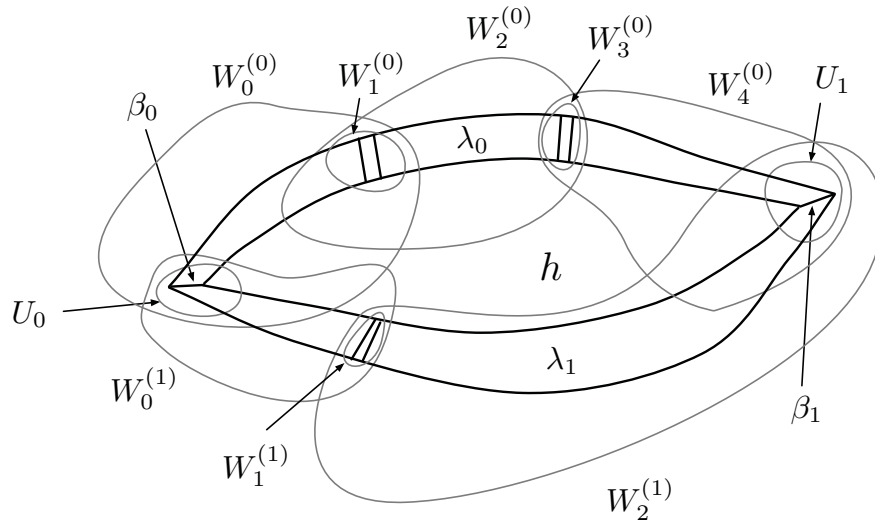

Or more schematically,

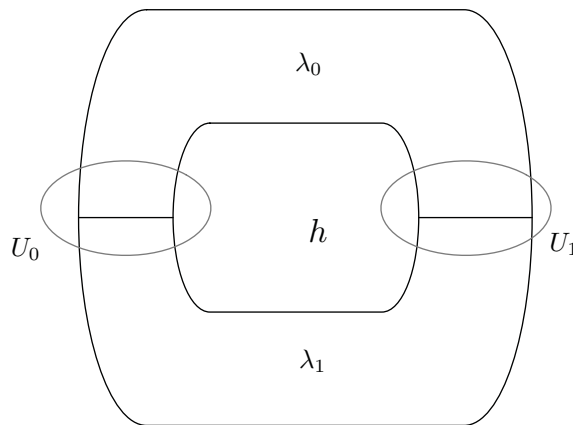

It is immediate from the definition that $[h] \in \langle [h], U_0, U_1, V_0, V_1 \rangle$. To see that for $[f] \in \langle [h], U_0, U_1, V_0, V_1 \rangle$, we have $[h] \in \langle [f], U_0, U_1, V_0, V_1 \rangle$, we can use the fact $\Pi_2^T(X)$ is a bigroupoid, and apply the compose/concatenate with the (weak) inverse of everything in sight. We do not display the all structure morphisms (associator etc.), relying on coherence for bicategories. If we have

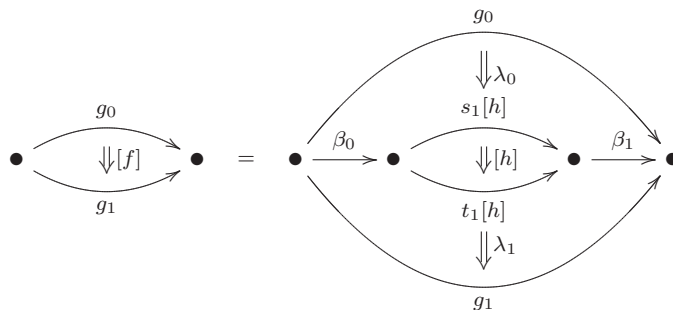

then

$$\begin{array}{c}
 \bullet \xrightarrow{\beta_0} \bullet \xrightarrow{s_1[h]} \bullet \xrightarrow{\beta_1} \bullet \\
 \Downarrow [h] \\
 \bullet \xrightarrow{t_1[h]} \bullet
 \end{array}
 =
 \begin{array}{c}
 \bullet \xrightarrow{s_1[h]} \bullet \\
 \uparrow \beta_0 \quad \downarrow \lambda_0^{-1} \beta_1 \\
 \bullet \xrightarrow{g_0} \bullet \\
 \Downarrow [f] \\
 \bullet \xrightarrow{g_1} \bullet \\
 \downarrow \beta_0 \quad \downarrow \lambda_1^{-1} \beta_1 \\
 \bullet \xrightarrow{t_1[h]} \bullet
 \end{array}$$

and so

$$\begin{array}{c}
 \bullet \xrightarrow{g_0} \bullet \\
 \Downarrow [h] \\
 \bullet \xrightarrow{g_1} \bullet
 \end{array}
 =
 \begin{array}{c}
 \bullet \xrightarrow{s_1[h]} \bullet \\
 \uparrow I \quad \downarrow \lambda_0^{-1} \beta_1 \quad \downarrow I \\
 \bullet \xrightarrow{g_0} \bullet \\
 \Downarrow [f] \\
 \bullet \xrightarrow{g_1} \bullet \\
 \downarrow I \quad \downarrow \lambda_1^{-1} \beta_1 \quad \downarrow I \\
 \bullet \xrightarrow{t_1[h]} \bullet
 \end{array}$$

We thus only need to show that the intersection

$$(23) \quad \langle [h], U_0, U_1, V_0, V_1 \rangle \cap \langle [h], U'_0, U'_1, V'_0, V'_1 \rangle$$

contains a basic open neighbourhood. Choose basic open neighbourhoods

$$\begin{aligned}
 V''_0 &:= N_{s_1[h]}(\mathfrak{p}_0, \prod_{i=0}^{n_0} W_i^{(0)}) \subset V_0 \cap V'_0, \\
 V''_1 &:= N_{t_1[h]}(\mathfrak{p}_1, \prod_{i=0}^{n_1} W_i^{(1)}) \subset V_1 \cap V'_1
 \end{aligned}$$

of the points $s_1[h], t_1[h]$ respectively and basic open neighbourhoods

$$\begin{aligned}
 U''_0 &\subset U_0 \cap U'_0 \cap W_0^{(0)} \cap W_0^{(1)}, \\
 U''_1 &\subset U_1 \cap U'_1 \cap W_{n_0}^{(0)} \cap W_{n_1}^{(1)}
 \end{aligned}$$

of the points $s_0[h], t_0[h]$ respectively. The four basic open neighbourhoods satisfy the conditions necessary to make the set

$$\langle [h], U_0'', U_1'', V_0'', V_1'' \rangle$$

a basic open neighbourhood. By inspection this is contained in (23) as required. \square

Now recall that the map $(s_1, t_1): B_2 \rightarrow B_1 \times B_1$ for B a bigroupoid factors through $B_1 \times_{B_0 \times B_0} B_1$. In the case of $\Pi_2^T(X)$, this gives a function

$$\Pi_2^T(X)_2 \rightarrow X^I \times_{X \times X} X^I \simeq LX.$$

of the underlying sets. If L_0X denotes the (path) component of the null-homotopic loops, then clearly $\text{im}(s, t) = L_0X$, which is open and closed in LX by our assumptions on X .

LEMMA 5.27. *With the topology from lemma 5.26, $(s_1, t_1): \Pi_2^T(X)_2 \rightarrow L_0X$ is a covering space when X is 2-well-connected.*

Proof. Recall that when X is 2-well-connected, LX is 1-well-connected, with path-connected basic open neighbourhoods. Let ω be a point in L_0X , corresponding to the paths $\gamma_1, \gamma_2: I \rightarrow X$ from x to y . Let $N := N_\omega^o(\mathfrak{p}, W)$ be a basic open neighbourhood in L_0X where

$$W = W_0 \prod_{i=1}^n W_i \prod W_{n+1} \prod_{j=n+2}^k W_j = W_0 \prod W^1 \prod W_{n+1} \prod W^2,$$

and without loss of generality $\mathfrak{p} = \mathfrak{p}_1 \vee \mathfrak{p}_2$, such that $N_{\gamma_1}(\mathfrak{p}_1, W^1)$ and $N_{\overline{\gamma_2}}(\mathfrak{p}_2, W^2)$ are basic open neighbourhoods. Consider now the pullback

$$\begin{array}{ccc} N \times_{L_0X} \Pi_2^T(X)_2 & \longrightarrow & \Pi_2^T(X)_2 \\ \downarrow & & \downarrow \\ N & \longrightarrow & L_0X \end{array}$$

which we want to show is a product $N \times \Pi_2^T(X)(\gamma_1, \gamma_2)$. For $[h] \in \Pi_2(X)(\gamma_1, \gamma_2) = (s_1, t_1)^{-1}(\omega)$, define the following basic open neighbourhood:

$$\langle [h] \rangle := \langle [h], W_0, W_{n+1}, W^1, W^2 \rangle$$

By definition, the neighbourhoods $N_{\gamma_1}(\mathfrak{p}_1, W^1)$ and $N_{\overline{\gamma_2}}(\mathfrak{p}_2, W^2)$ are path-connected, so the map $\langle [h] \rangle \rightarrow N$ is surjective. Using the same arguments as in the proof of proposition 5.23, it is also surjective and open, hence an isomorphism. We also know that if $[h] \neq [h']$, the neighbourhood $\langle [h] \rangle$ is disjoint from $\langle [h'] \rangle$, because if they shared a common point, they would be equal (see the proof of lemma 5.26). Every 2-track in $N \times_{L_0X} \Pi_2(X)_2 \rightarrow N$ lies in some $\langle [h] \rangle$, so there is an isomorphism

$$N \times_{L_0X} \Pi_2^T(X)_2 \simeq N \times \Pi_2^T(X)(\gamma_1, \gamma_2)$$

and $\Pi_2^T(X)_2 \rightarrow L_0X$ is a covering space. \square

REMARK 5.28. Since L_0X is open and closed in LX , we know that $\Pi_2^T(X)_2 \rightarrow LX$ is a covering space where the fibres over the complement $LX - L_0X$ are empty.

This lemma implies that the two composite maps $s_1, t_1: \Pi_2^T(X)_2 \rightarrow LX \rightrightarrows X^I$ are continuous. In fact these are the source and target for a topological groupoid

LEMMA 5.29. *The 2-tracks and paths in a space, with the topologies as above, form a topological groupoid $\underline{\Pi_2^T(X)}_1 := (\Pi_2^T(X)_2 \rightrightarrows X^I)$.*

Proof. We have already seen that the source and target maps are continuous, we only need to show that the unit map $\text{id}_{(-)}$, composition $+$ and inversion $-(-)$ are continuous. For the unit map, let $\gamma \in X^I$, and $\langle \text{id}_\gamma \rangle := \langle \text{id}_\gamma, U_0, U_1, V_0, V_1 \rangle$ a basic open neighbourhood. Define $C := \text{id}_{(-)}^{-1}(\langle \text{id}_\gamma \rangle)$ and consider the image of C under $\text{id}_{(-)}$:

$$\begin{aligned} \text{id}_{(-)}(C) &= \{\eta \in \langle \text{id}_\gamma \rangle \mid \eta = [\lambda_1 + (\text{id}_{\beta_1} \cdot (\text{id}_\gamma \cdot \text{id}_{\beta_0})) + \lambda_0] = \text{id}_\chi\} \\ &= \{\eta \in \langle \text{id}_\gamma \rangle \mid \eta = [\lambda_1 + \text{id}_{\beta_1 \cdot (\gamma \cdot \beta_0)} + \lambda_0] = [\lambda_1 + \lambda_0] = \text{id}_\chi\}. \end{aligned}$$

Then $s_1(\lambda_1) = t_1(\lambda_0) = \beta_1 \cdot (\gamma \cdot \beta_0)$, $t_1(\lambda_1) = s_1(\lambda_0) = \chi$ and $\lambda_0 = -\lambda_1 =: \lambda$. As λ_0 is a path in V_0 and λ_1 a path in V_1 , we see that λ is a path in $V_0 \cap V_1$ which implies $\chi \in V_0 \cap V_1$. If we choose a basic neighbourhood $V_2 \subset V_0 \cap V_1 \subset X^I$ of γ , then $\text{id}_{(-)}(V_2) \subset \langle \text{id}_\gamma \rangle$, and so the unit map is continuous.

We now need to show the map

$$+: \Pi_2^T(X)_2 \times_{X^I} \Pi_2^T(X)_2 \rightarrow \Pi_2^T(X)_2$$

is continuous. Let $[h_1], [h_2]$ be a pair of composable arrows, and let $\langle [h_2 + h_1] \rangle := \langle [h_2 + h_1], U_0, U_1, V_0, V_2 \rangle$ be a basic open neighbourhood. Choose a basic open neighbourhood $V_1 = N_\gamma(\mathfrak{p}, W)$ of $\gamma = s_1[h_2] = t_1[h_1]$ in X^I such that the open neighbourhoods U_0 and U_1 are the first and last basic open neighbourhoods in the collection W . Consider the image

$$\mathcal{I} := +(\langle [h_2], U_0, U_1, V_1, V_2 \rangle \times_{X^I} \langle [h_1], U_0, U_1, V_0, V_1 \rangle).$$

The following diagram is a schematic of what an element in the image looks like:

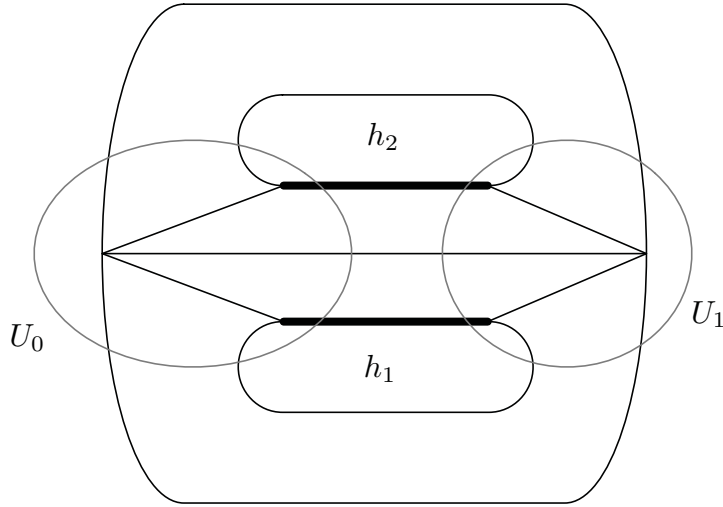

The thick lines are identified, and the circles are the basic opens $U_0, U_1 \subset X$. Topologically this is a disk with a cylinder $I \times S^1$ glued to it along some $I \times \{\theta\}$. For this 2-track to be an element of our original neighbourhood $\langle [h_2 + h_1] \rangle$ we need to show that the surface that goes ‘under’ the cylinder is homotopic (rel boundary) to the one that goes ‘over’ the cylinder, i.e. that there is a filler for the cylinder. Then a generic 2-track $[f_2 + f_1] \in \mathcal{I}$ is equal to one of the form

$$[\lambda_1 + (\text{id}_{\beta_1} \cdot ((h_2 + h_1) \cdot \text{id}_{\beta_0})) + \lambda_0] \in \langle [h_2 + h_1] \rangle$$

which schematically looks like

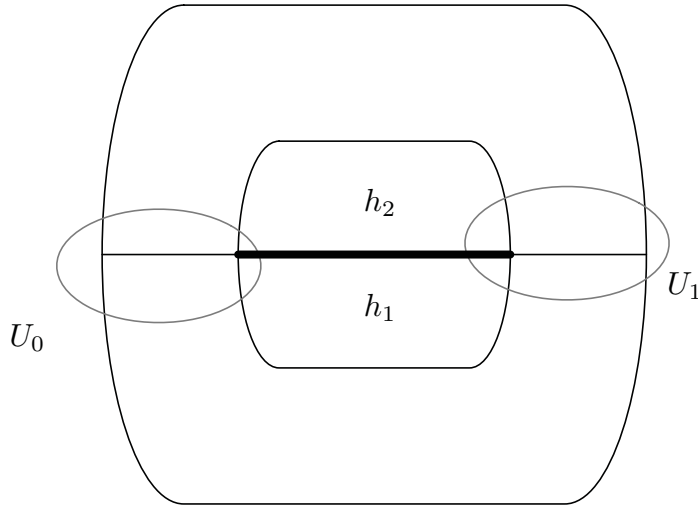

The trapezoidal regions in the first picture correspond to paths in V_1 , which under the identification of the marked edges paste to form a loop in V_1 . As X^I is 1-well-connected, there is a filler for this loop in X^I . This implies that there is the homotopy we require, and so $+$ is continuous.

It is clear from the definition of the basic open neighbourhoods of $\Pi_2^T(X)_2$ that

$$-\langle [h], U_0, U_1, V_0, V_1 \rangle = \langle [-h], U_0, U_1, V_1, V_0 \rangle$$

and so $-(-)$ is manifestly continuous. \square

The maps $ev_0, ev_1: X^I \rightarrow X$ give us a functor $\underline{\Pi}_2^T(X)_1 \rightarrow \text{disc}(X \times X)$ of topological groupoids. We now have all the ingredients for a topological bigroupoid, but first a lemma about pasting open neighbourhoods of paths with matching endpoints.

Let $\gamma_1, \gamma_2 \in X^I$ be paths such that $\gamma_1(1) = \gamma_2(0)$ and let $N_1 := N_{\gamma_1}(\mathbf{p}_1, W^1)$, $N_2 := N_{\gamma_2}(\mathbf{p}_2, W^2)$ be basic open neighbourhoods. For an open set $U \subset W_n^1 \cap W_m^2$ (these being the last open sets in their respective collections), define subsets of X^I ,

$$M_1 := \{\eta \in N_1 \mid \eta(1) \in U\}, \quad M_2 := \{\eta \in N_2 \mid \eta(0) \in U\}.$$

We define the pullback $M_1 \times_X M_2$ as a subset of $X^I \times_X X^I$ where this latter pullback is by the maps ev_0, ev_1 . The proof of the following lemma should be obvious.

LEMMA 5.30. *The image of the set $M_1 \times_X M_2$ under concatenation of paths is the basic open neighbourhood*

$$N_{\gamma_2 \cdot \gamma_1}(\mathbf{p}_1 \vee \mathbf{p}_2, W^1 \amalg U \amalg W^2).$$

We shall denote the image of $M_1 \times_X M_2$ as in the lemma by $N_1 \#_U N_2$.

PROPOSITION 5.31. $\underline{\Pi}_2^T(X)$ is a topological bigroupoid.

Proof. We need to show that the identity assigning functor

$$\text{disc}(X) \rightarrow \underline{\Pi}_2^T(X)_1,$$

the concatenation and reverse functors,

$$\begin{aligned} (-) \cdot (-) &: \underline{\Pi}_2^T(X)_1 \times_{\text{disc}(X)} \underline{\Pi}_2^T(X)_1 \rightarrow \underline{\Pi}_2^T(X)_1, \\ \overline{(-)} &: \underline{\Pi}_2^T(X)_1 \rightarrow \underline{\Pi}_2^T(X)_1, \end{aligned}$$

and the structure maps (22) are continuous. The first follows from lemma 5.19, and the continuity of the object¹ components of the second two are just lemmas 5.18 and 5.20. On the arrow space, the reverse functor clearly sends basic open neighbourhoods to basic open neighbourhoods,

$$\overline{\langle [h], U_0, U_1, V_0, V_1 \rangle} = \langle \overline{[h]}, U_1, U_0, V_0, V_1 \rangle,$$

and so is continuous.

Let $\langle [h_2 \cdot h_1], U_0, U_1, V_0, V_1 \rangle$ be a basic open neighbourhood in $\underline{\Pi}_2^T(X)_2$, where we have the basic open neighbourhoods

$$V_0 = N_{s_1[h_2 \cdot h_1]}(\mathbf{p}_0, W^0), \quad V_1 = N_{t_1[h_2 \cdot h_1]}(\mathbf{p}_1, W^1)$$

in X^I where

$$W^0 = \prod_{i=0}^n W_i^0, \quad W^1 = \prod_{j=0}^m W_j^1, \quad n, m \geq 3.$$

¹Referring to the object space X^I of $\underline{\Pi}_2^T(X)_1$. Likewise, ‘arrow components’ refer to the arrow space of this groupoid, corresponding to the 2-arrow space of the bigroupoid

We can assume that $\mathfrak{p}_0 = \mathfrak{q}_1^0 \vee \mathfrak{q}_2^0$ and $\mathfrak{p}_1 = \mathfrak{q}_1^1 \vee \mathfrak{q}_2^1$. Let the partition groupoids be given by the following data

$$\begin{aligned}\mathfrak{q}_1^0 &: \{t_1, \dots, t_k\}, \\ \mathfrak{q}_2^0 &: \{t_{k+2}, \dots, t_n\}, \\ \mathfrak{q}_1^1 &: \{t'_1, \dots, t'_l\}, \\ \mathfrak{q}_2^1 &: \{t'_{l+2}, \dots, t'_m\}.\end{aligned}$$

We now define the neighbourhoods

$$\begin{aligned}V_1^0 &:= N_{s_1[h_1]}(\mathfrak{q}_1^0, \prod_{i=0}^k W_i^0), \\ V_2^0 &:= N_{s_1[h_2]}(\mathfrak{q}_2^0, \prod_{i=k+2}^n W_i^0), \\ V_1^1 &:= N_{t_1[h_1]}(\mathfrak{q}_1^1, \prod_{j=0}^l W_j^1), \\ V_2^1 &:= N_{t_1[h_2]}(\mathfrak{q}_2^1, \prod_{j=l+2}^m W_j^1).\end{aligned}$$

Consider the image of the fibred product $\langle [h_1], U_0, U_1, V_1^0, V_1^1 \rangle \times_X \langle [h_2], U_1, U_2, V_2^0, V_2^1 \rangle$ under concatenation, any element of which looks like

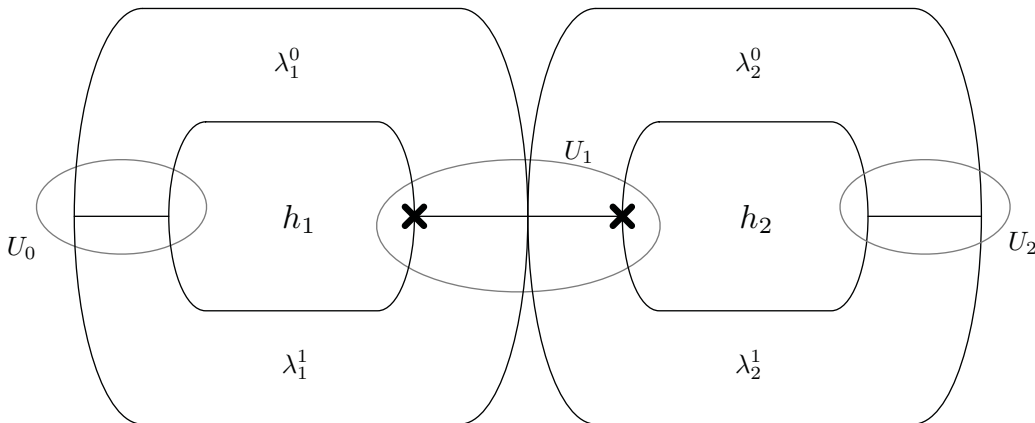

where the two points marked by **X**'s are identified, so the line between them is a circle. Since the open set $U_1 \subset X$ is 1-connected, there is a filler for this circle, and there is a homotopy between this surface and one of the form

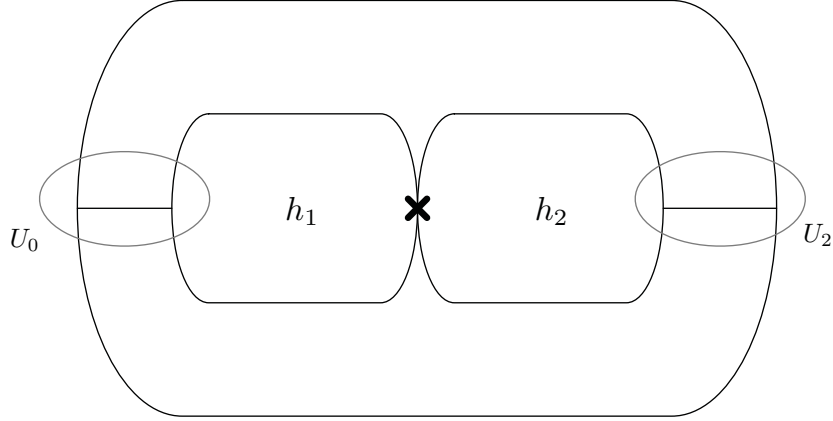

Also, by lemma 5.30, the surfaces $\lambda_2^0 \cdot \lambda_1^0$, $\lambda_2^1 \cdot \lambda_1^1$ are elements of $V_1^0 \#_{U_1} V_2^0$ and $V_1^1 \#_{U_1} V_2^1$ respectively. Then the image of the open set $\langle [h_1], U_0, U_1, V_1^0, V_1^1 \rangle \times_X \langle [h_2], U_1, U_2, V_2^0, V_2^1 \rangle$ under concatenation is contained in $\langle [h_2 \cdot h_1], U_0, U_1, V_0, V_1 \rangle$.

The assiduous reader will have already noticed that the following relations hold for the (component maps of) the structure morphisms of $\Pi_2^T(X)$:

$$l = r \circ \overline{(-)}, \quad e = -(i \circ \overline{(-)}).$$

This means that we only need to check the continuity of a and two of the other four structure maps.

For the associator $a: X^I \times_X X^I \times_X X^I \rightarrow \Pi_2^T(X)_2$, we take a basic open neighbourhood

$$\langle a_{\gamma_1 \gamma_2 \gamma_3} \rangle := \langle a_{\gamma_1 \gamma_2 \gamma_3}, U_0, U_1, V^0, V^1 \rangle$$

and by continuity of concatenation of paths choose a basic open neighbourhood N of $(\gamma_1, \gamma_2, \gamma_3)$ in $X^I \times_X X^I \times_X X^I$ whose image under the composite

$$X^I \times_X X^I \times_X X^I \xrightarrow{a} \Pi_2^T(X)_2 \xrightarrow{(s_1, t_1)} X^I \times_{X \times X} X^I$$

is contained in $V^0 \times_{X \times X} V^1$. Also let $U \subset X^I \times_X X^I \times_X X^I$ be a basic open neighbourhood whose image under

$$X^I \times_X X^I \times_X X^I \xrightarrow{a} \Pi_2^T(X)_2 \xrightarrow{(s_1, t_1)} X^I \times_{X \times X} X^I \xrightarrow{(s_0, t_0)} X_0 \times X_0$$

is contained within $U_0 \times U_1$. Then if $N' \subset N \cap U$ is a basic open neighbourhood of $(\gamma_1, \gamma_2, \gamma_3)$, its image under a is contained in $\langle a_{\gamma_1 \gamma_2 \gamma_3} \rangle$, so a is continuous.

The continuity of the other structure maps is proved similarly, and left as an exercise for the reader. \square

It is expected that for a reasonable definition of ana-2-functor² internal to **Top** there is a weak equivalence between this topological bigroupoid and an ordinary bigroupoid (i.e. one that is topologically discrete). In any case, we can define strict 2-functors between topological bigroupoids, and these are the only such morphisms we shall need here.

²This name is due to Urs Schreiber, although the idea of such a thing is probably implicit in the work of Makkai on n -categories.

DEFINITION 5.32. A *strict 2-functor* $F: B \rightarrow B'$ between topological bigroupoids B, B' consists of a continuous map $F_0: B_0 \rightarrow B'_0$ and a functor $\underline{F}_1: \underline{B}_1 \rightarrow \underline{B}'_1$ commuting with (S, T) and the various structure maps from definition 5.25.

We define the category of topological bigroupoids and continuous strict 2-functors and denote it by TBG . Let \mathbf{Top}_{2wc} denote the full subcategory (of \mathbf{Top}) of 2-well-connected spaces

THEOREM 5.33. *There is a functor*

$$\Pi_2^T: \mathbf{Top}_{2wc} \rightarrow TBG$$

given on objects by the construction described above.

Proof. We only need to check that the strict 2-functor $f_*: \Pi_2^T(X) \rightarrow \Pi_2^T(Y)$ induced by a map $f: X \rightarrow Y$ is continuous. Recall from [HKK01] that this strict 2-functor is given by f on objects and post composition with f on 1- and 2-arrows. We then just need to check that this is continuous on 2-arrows, as it is obvious that it is continuous on objects and 1-arrows.

Let $\langle [f \circ h] \rangle := \langle [f \circ h], U_0^Y, U_1^Y, V_0, V_1 \rangle$ be a basic open neighbourhood in $\Pi_2^T(Y)_2$, and choose basic open neighbourhoods $W_\epsilon \in f^{-1}(V_\epsilon)$ in X^I for $\epsilon = 0, 1$. If $W_0 = \coprod_{i=0}^n W_i^0$ and $W_1 = \coprod_{i=0}^m W_i^1$, then choose basic open neighbourhoods

$$U_0^X \subset f^{-1}(U_0^Y) \cap W_0^0 \cap W_0^1, \quad U_1^X \subset f^{-1}(U_1^Y) \cap W_n^0 \cap W_m^1$$

in X . It is then clear that $f_*(\langle [h], U_0^X, U_1^X, W_0, W_1 \rangle) \subset \langle [f \circ h] \rangle$, and so f_* is a continuous 2-functor. \square

3. The canonical 2-connected cover

Since the canonical covering space $X^{(2)}$ of a pointed, 1-well-connected space (X, x) is the source fibre at x of the fundamental groupoid $\Pi_1(X)$, we make the following definitions.

DEFINITION 5.34. Let B be a topological bigroupoid. The *source fibre* $S^{-1}(b)$ of B at an object $b \in B_0$ is the strict pullback

$$\begin{array}{ccc} S^{-1}(b) & \hookrightarrow & \underline{B}_1 \\ \downarrow & & \downarrow (S, T) \\ \text{disc}(\{b\} \times B_0) & \hookrightarrow & \text{disc}(B_0 \times B_0) \end{array}$$

and is a subgroupoid of \underline{B}_1 . We regard $S^{-1}(b)$ as being equipped with the functor $S^{-1}(b) \rightarrow B_0$ given by restricting T .

DEFINITION 5.35. Let (X, x) be a pointed, connected, 2-well-connected space. The *canonical 2-connected cover* of X is the source fibre of $\Pi_2^T(X)$ at x .

We shall spend the next two sections proving that the canonical 2-connected cover: 1) is indeed 2-connected, 2) is functorial and 3) that for certain X – not all! – it is a 2-covering space. This is not really a deficiency, but an indicator of the presence of a richer theory (see remark 5.52). We first show that the definition is functorial.

LEMMA 5.36. *Let $F: B \rightarrow B'$ be a strict 2-functor between topological bigroupoids and $b \in B_0$. There is a functor $S_B^{-1}(b) \rightarrow S_{B'}^{-1}(F_0(b))$ covering F_0 .*

Proof. The desired functor arises from the universal property of the strict pull-back:

$$\begin{array}{ccccc}
 S^{-1}(b) \hookrightarrow & & B_1 & \xrightarrow{E_1} & B'_1 \\
 \downarrow & \dashrightarrow \text{!} & \downarrow & & \downarrow \\
 S^{-1}(b) & \xrightarrow{\quad} & S^{-1}(b') & \xrightarrow{\quad} & B'_1 \\
 \downarrow & & \downarrow & \text{(S,T)} & \downarrow \\
 \text{disc}(\{b\} \times B_0) \hookrightarrow & & \text{disc}(B_0 \times B_0) & \xrightarrow{F_0^2} & \text{disc}(B'_0 \times B'_0) \\
 \downarrow & & \downarrow & & \downarrow \\
 \text{disc}(\{b'\} \times B'_0) \hookrightarrow & & \text{disc}(B'_0 \times B'_0) & & \text{disc}(B'_0 \times B'_0)
 \end{array}$$

□

The source and target maps give us a map $(s, t): X^{(2)} \rightarrow P_x X \times_X P_x X \simeq \Omega_x X$ which factors through $\Omega_0 X$, the path-component of the constant loop in ΩX .

LEMMA 5.37. *The map $(s, t): X_1^{(2)} \rightarrow \Omega_0 X$ exhibits the arrow space of $X^{(1)}$ as a covering space of $\Omega_0 X$, isomorphic to $(\Omega_0 X)^{(1)}$*

Proof. We know that $X_1^{(2)} \rightarrow \Omega_0 X$ is a covering space, because it is given by the pullback

$$\begin{array}{ccc}
 X_1^{(2)} & \longrightarrow & \Pi_2^T(X)_2 \\
 \downarrow & & \downarrow \\
 \Omega_0 X & \hookrightarrow & L_0 X
 \end{array}$$

We will now show that the underlying sets of $X_1^{(2)}$ and $(\Omega_0 X)^{(1)}$ are isomorphic, and then that they are isomorphic as spaces. In what follows, let S^1 be the unit circle in \mathbb{C} , with basepoint 1, and let D^2 be the closed unit disk in \mathbb{C} (with S^1 as boundary), also pointed by 1. Using adjointness freely, we have the following chain

of isomorphisms of sets

$$\begin{aligned}
\{I \xrightarrow{f} \Omega_0 X \mid f(0) = \underline{x}\} &\simeq \{I \times S^1 \xrightarrow{g} X \mid g(t, 1) = x \ \forall t \in I, \ g(0, z) = x \ \forall z \in S^1\} \\
&\simeq \{D^2 \xrightarrow{h} X \mid h(z) = x \ \forall z \in [0, 1] \subset \mathbb{C}\} \\
&\stackrel{*}{\simeq} \{D^2 \xrightarrow{j} X \mid j(1) = x\} \\
&\simeq \{I^2 \xrightarrow{k} X \mid k(t, 0) = x \ \forall t \in I, \ k(-, 1): I \rightarrow X \text{ is constant}\}
\end{aligned}$$

where the isomorphism marked $*$ arises using a homeomorphism $D^2/[0, 1] \simeq D^2$. We shall conflate these two sets, mostly just for convenience of language (what follows would not change except for the constant mention of the above composite isomorphism). Our two spaces of interests have underlying sets which are quotients of this set. There is a homotopy between surfaces $k, k': I^2 \rightarrow X$ if and only if there is a homotopy between the corresponding paths $f, f': I \rightarrow \Omega_0 X$, so that these quotient sets are also isomorphic. Moreover, this isomorphism commutes with the maps to $\Omega_0 X$ from (the underlying sets of) $(\Omega_0 X)^{(1)}$ and $X_1^{(2)}$.

Now consider a point $f \in (\Omega_0 X)^{(1)}$ and a basic open neighbourhood

$$(24) \quad N_{[f]}(N_{f(1)}^o(\mathfrak{p}, W) \times_{L_0 X} \Omega_0 X)$$

of $[f]$. We assume without loss of generality that $\mathfrak{p} = \mathfrak{p}_1 \vee \mathfrak{p}_2$, and that

$$W = W_0 \coprod_{i=1}^n W_i \coprod W_{n+1} \coprod_{j=n+2}^k W_j = W_0 \coprod W^1 \coprod W_{n+1} \coprod W^2.$$

Under the isomorphism established above, the neighbourhood (24) is mapped onto the basic open neighbourhood

$$\langle [k], W_0, W_{n+1}, W^1, W^2 \rangle \times_{L_0 X} \Omega_0 X,$$

in $X_1^{(2)}$ and so we have a homeomorphism $(\Omega_0 X)^{(1)} \simeq X_1^{(2)}$ over $\Omega_0 X$. \square

The following is one of the key results of this chapter, and justifies the appellation ‘2-connected’.

PROPOSITION 5.38. *The groupoid $X^{(2)}$ is 2-connected.*

Proof. The object space $X_0^{(2)} = P_x X$ is contractible and so is 2-connected, and the arrow space $X_1^{(2)} \simeq (\Omega_0 X)^{(1)}$ is 1-connected. By proposition 2.112 $X^{(2)}$ is 2-connected. \square

Let TG_{*0}^{str} be the underlying 1-category of TG_*^{str} , the 2-category of pointed groupoids, strictly pointed functors and pointed transformations. Define $TG_{*0}^{str}/\mathbf{Top}_*$ to be the full subcategory of $(TG_{*0}^{str})^2$ on the pointed functors with codomain a space.

THEOREM 5.39. *There is a functor*

$$\begin{aligned}
\mathbf{Top}_{2wc,*} &\rightarrow TG_{*0}^{str}/\mathbf{Top}_* \\
(X, x) &\mapsto ((X^{(2)}, \underline{x}) \rightarrow (X, x))
\end{aligned}$$

where $X^{(2)}$ is a 2-connected topological groupoid.

Proof. This is a simple application of lemma 5.36, and the strict preservation of basepoints follows immediately. \square

We can regard this functor as landing in TG_{*0}/\mathbf{Top}_* which is the analogous category where we allow weakly pointed functors. Now since a functor from a category to the 1-category underlying a 2-category extends to a strict 2-functor to the 2-category itself, we can see this functor as giving a strict 2-functor $\mathbf{Top}_{2wc,*} \rightarrow TG_{*0}/\mathbf{Top}_*$. We can then use the strict 2-functor $TG_* \rightarrow \mathbf{Ana}_*$ to give us a strict 2-functor

$$\mathbf{Top}_{2wc,*} \rightarrow \mathbf{Ana}_*/\mathbf{Top}_*$$

where the bicategory $\mathbf{Ana}_*/\mathbf{Top}_*$ has the same objects as TG_{*0}/\mathbf{Top}_* .

4. A 2-connected 2-covering space

Now we want $X^{(2)}$ to be a 2-covering space, so it needs a local trivialisation. This is where the topology on X makes an impact. For an open set U we have the pullback groupoid $X_U^{(2)} = U \times_X X^{(2)}$. To trivialise over U we need a t-d groupoid D , a cover $V \rightarrow U \times D_0$ and a weak equivalence

$$(U \times D)[V] \xrightarrow{\sim} X_U^{(2)}.$$

Notice that a functor like this for each element of an open cover of X implies the existence of local sections of $P_x X \rightarrow X$. We need to thus check when this is possible.

DEFINITION 5.40. A topological space X is called *locally contractible* if it has an open neighbourhood basis such that the inclusion $U \hookrightarrow X$ of each basic open neighbourhood is null-homotopic.

LEMMA 5.41. *The path fibration $P_x X \rightarrow X$ of a path-connected space admits local sections if and only if X is locally contractible.*

Proof. Let U be a basic open neighbourhood. Let $H: U \times I \rightarrow X$ be a null-homotopy such that $H(-, 0): U \rightarrow X$ is the constant map at x . This is always possible as given any null-homotopy h' with $H'(u, 0) = y$ for all $u \in U$ we can always compose with a homotopy between the maps $U \rightarrow X$ constant at x and y respectively. Then by adjointness we have a continuous map $h: U \rightarrow X^I$ such that $ev_0 \circ h(u) = x$ for all $u \in U$, and so h factors through the inclusion $P_x X \rightarrow X^I$. Then $ev_1 \circ h: U \rightarrow X$ is the inclusion, and so h is a local section. If $\sigma: U \rightarrow P_x X$ is a local section, we have by adjointness a homotopy $U \times I \rightarrow X$ between the inclusion and the constant map at x . \square

As a result, $PX \rightarrow X$ is an \mathcal{O} -epimorphism if and only if X is locally contractible. More generally, for a subspace $Y \hookrightarrow X$, the pullback $Y \times_X PX \rightarrow Y$ admits a section if and only if the inclusion is null-homotopic. As a result, a necessary condition that the groupoid $X^{(2)}$ is a 2-covering space is that the 2-well-connected space X is locally contractible. We shall in the rest of this section show that this condition is also sufficient.

We know that a 1-connected space is always isomorphic to its canonical covering space. Here we have a slightly weaker result, in that there is only a weak homotopy equivalence at the level of 2-types.³

COROLLARY 5.42. *Let Y be a connected, locally 1-connected, 2-connected space, and choose a basepoint y . Then $Y^{(2)} \rightarrow Y$ is surjective and fully faithful. Moreover it is essentially \mathcal{O} -surjective if and only if Y is locally contractible. The 2-functor $\Pi_2(Y^{(2)}) \rightarrow \Pi_2(Y)$ is an equivalence of bigroupoids whether Y is locally contractible or not.*

Proof. As Y is connected, $p: Y^{(2)} \rightarrow Y$ is clearly surjective, as $P_y Y \rightarrow Y$ is surjective. As Y is 2-connected, there is exactly one 2-track between any two paths that have the same endpoints, implying that $(s, t): Y_1^{(2)} \rightarrow P_y Y \times P_y Y$ is injective. If we show that $Y_1^{(2)}$ has the subspace topology, then $Y_1^{(2)} \simeq P_y Y \times_Y P_y Y$, which means that p is fully faithful. But we know that $Y_1^{(2)} \rightarrow P_y Y \times P_y Y$ is a covering projection, and so a local homeomorphism, hence isomorphic to its image. We have actually just shown that $Y^{(2)}$ is isomorphic to $\tilde{C}(P_y Y)$. Now a functor $X \rightarrow \text{disc}(M)$ is essentially \mathcal{O} -surjective if and only if $X_0 \rightarrow M$ admits local sections, but from lemma 5.41 we know this is precisely the case when Y is locally contractible.

To show that we have an equivalence of fundamental bigroupoids, notice that both $\Pi_2(Y^{(2)})$ and $\Pi_2(\text{disc}(Y))$ are equivalent to the trivial bigroupoid, and so to each other, the 2-functor p_* necessarily being an equivalence. \square

In order to prove $X^{(2)} \rightarrow X$ is locally trivial, we will use the topological properties of the fundamental bigroupoid. In fact, we shall present conditions on a general topological groupoid such that its source fibres are 2-covering spaces. We will do this without talking explicitly about local trivialisations. We know that if $Y \rightarrow X$ is a map with discrete fibres such that there is a cover $U \rightarrow X$ over which there are sections through every point in Y , then $Y \rightarrow X$ is necessarily a covering space. The fibre of the trivial covering space over each open set U_α is given by the set of sections over U_α . We shall imitate this definition somewhat, by defining a t-d groupoid of sections of a functor $Y \rightarrow \text{disc}(X)$ where Y is now a groupoid.

DEFINITION 5.43. Let Y be a groupoid and $p: Y \rightarrow \text{disc}(X)$ a functor. For an open set $i: U \hookrightarrow X$, the *groupoid of anasections of p over U* is the full subgroupoid

$$\Gamma(U, Y) \hookrightarrow \mathbf{Ana}(\text{disc}(U), Y)$$

with objects $(V, \sigma): U \rightarrow Y$ such that $(Y_0, p) \circ (V, \sigma) \simeq (U, i)$. We give $\Gamma(U, Y)$ the discrete topology, so that it is a t-d groupoid.

Note that transformations between anasections are automatically vertical, because all the arrows of Y are vertical. Now we need an analogue of the evaluation map on sections of maps of spaces but we can only expect it to be an anafunctor in this setting.

³It is expected that this will be a weak homotopy equivalence – a map inducing isomorphisms on homotopy groups, given a definition of π_n on groupoids for all $n \geq 0$ [**Rob**].

LEMMA 5.44. Let Y be a groupoid and $p: Y \rightarrow \text{disc}(X)$ a functor. Given any open set $U \hookrightarrow X$ there is an anafunctor

$$\Gamma(U, Y) \times \text{disc}(U) \dashrightarrow Y \times_{\text{disc}(X)} \text{disc}(U) =: Y_U$$

commuting with the obvious functors to $\text{disc}(U)$.

Proof. To define an anafunctor, we first need an open cover of $U \times \Gamma(U, Y)_0$ – but there is one ready supplied:

$$\underline{V} := \coprod_{(V, \sigma) \in \Gamma(U, Y)_0} V_\sigma \rightarrow U \times \Gamma(U, Y)_0.$$

The space $V_\sigma = V$ will be said to be *labelled* by σ . The induced groupoid

$$(\Gamma(U, Y) \times \text{disc}(U)) [\underline{V}]$$

has as arrows the space

$$\coprod_{\lambda: \sigma \rightarrow \sigma' \in \Gamma(U, Y)_1} V_\sigma \times_U V_{\sigma'}$$

and the source and target are given by projection on the appropriate factor, labelled by the source and target of the arrow λ resp. The unit map is given by the inclusions $V_\sigma \rightarrow V_\sigma \times_U V_\sigma$ into the fibred product labelled by id_σ . Composition is just vertical composition of transformations at the level of labels, together with projections

$$V_\sigma \times_U V_{\sigma'} \times_U V_{\sigma''} \rightarrow V_\sigma \times_U V_{\sigma''}.$$

On objects the functor to Y is just given by

$$\coprod_{(V, \sigma) \in \Gamma(U, Y)_0} V_\sigma \xrightarrow{\text{II}\sigma} Y.$$

Now a transformation $\lambda: (V_\sigma, \sigma) \Rightarrow (V_{\sigma'}, \sigma')$ is just given by its component map, $\lambda: V_\sigma \times_U V_{\sigma'} \rightarrow Y_1$, so we define the arrow component of our desired functor by

$$\coprod_{\lambda: \sigma \rightarrow \sigma' \in \Gamma(U, Y)_1} V_\sigma \times_U V_{\sigma'} \xrightarrow{\text{II}\lambda} Y_1.$$

Source and target are respected by definition of the transformation, and the rest of the conditions necessary for this to give a functor are easily checked. \square

Given a fixed open set U we shall denote the t-d groupoid $\Gamma(U, Y)$ by Γ . The functor $(\Gamma \times U)[\underline{V}] \rightarrow Y_U$ described in the lemma will be denoted Σ_U . Our aim is to find conditions on a topological bigroupoid B such that for each source fibre $S^{-1}(b)$ (which is a groupoid over the space of objects), we can find $U \hookrightarrow B_0$ with Σ_U an \mathcal{O} -equivalence, so that $S^{-1}(b) \rightarrow \text{disc}(B_0)$ is locally trivial with weakly discrete fibre – in other words a 2-covering space.

DEFINITION 5.45. Let B be a topological bigroupoid such that $X = B_0$ is locally path-connected. We say B is *locally trivial* if the following conditions hold:

- (I) The image of $(s_1, t_1): B_2 \rightarrow B_1 \times_{B_0} B_1$ is open, and $B_2 \rightarrow \text{im}(s_1, t_1)$ admits local sections.

- (II) For every $b, b' \in B_0$ there is an open neighbourhood U of b' such that for all $g \in S^{-1}(b)_0$ there is an anasection (V, σ) such that there is an arrow $g \xrightarrow{\cong} \sigma(v)$ in $S^{-1}(b)$ for some $v \in V$.

If B satisfies just condition (II) it will be called a *submersive bigroupoid*.⁴

An immediate implication of the definition is that $S^{-1}(b)_0 \rightarrow B_0$ admits local sections, as an anasection $(V, \sigma): \text{disc}(U) \rightarrow \underline{B}_1$ can be restricted to a single open set $V_k \subset V$ of B_0 . In fact, composing a local section with the restriction of the inversion functor $\underline{B}_1 \rightarrow \underline{B}_1$, we get local sections of target fibre $T^{-1}(b)_0 \rightarrow B_0$. Given a pair of local sections, one of the source fibre and one of the target fibre, they determine a map to the fibred product $\underline{B}_1 \times_{\text{disc}(B_0)} \underline{B}_1$, which can be composed with the horizontal composition functor to give a local section of $(S, T): \text{Obj}(\underline{B}_1) \rightarrow B_0 \times B_0$. Another implication of the definition is that for a submersive bigroupoid, the functor Σ_U is essentially surjective, but not necessarily essentially \mathcal{O} -surjective.

We will not actually use this definition as it stands, because we are only interested in locally trivial bigroupoids that satisfy a stronger version of condition (I):

DEFINITION 5.46. A topological bigroupoid B will be called *locally weakly discrete* if

- (I') The map $(s_1, t_1): B_2 \rightarrow B_1 \times_{B_0} B_1$ is a covering space.

Note that condition (I') implies condition (I) from definition 5.45.

This nomenclature is consistent with the usage of the word ‘locally’ in the theory of bicategories, in that condition (I') implies that the groupoid $\underline{B}(a, b) = (S, T)^{-1}(a, b)$ is locally trivial with discrete hom-spaces, and hence weakly discrete. However, if we merely assume the fibres of $\underline{B}_1 \rightarrow \text{disc}(B_0 \times B_0)$ are weakly discrete, it does not follow that we have a locally weakly discrete bigroupoid as defined above.

PROPOSITION 5.47. *For B a locally trivial bigroupoid, the functor Σ_U is essentially \mathcal{O} -surjective for all choices of objects $b \in B_0$ and open sets $U \subset B_0$.*

Proof. The essence of the proof is to show that the essentially surjective functor Σ_U is essentially \mathcal{O} -surjective. Denote the groupoid $S^{-1}(b) \times_{B_0} \text{disc}(U)$ by A , so that Σ_U is a functor making the following diagram commute

$$\begin{array}{ccc} (\text{disc}(U) \times \Gamma)[V] & \xrightarrow{\Sigma_U} & A \\ & \searrow & \swarrow \\ & \text{disc}(U) & \end{array}$$

⁴Compare with the definition of a topological submersion: a map $p: M \rightarrow N$ of spaces such that every $m \in M$ there is a local section $s: U \rightarrow M$ of p such that $m = s(u)$.

Notice that the pullback that is used to define essential \mathcal{O} -surjectivity, derived as in the diagram

$$\begin{array}{ccccc}
 \underline{V} \times_{A_0} A_1 & \longrightarrow & A_1 & \xrightarrow{t} & A_0 \\
 \downarrow & & \downarrow s & & \\
 \underline{V} & \xrightarrow{\Sigma_{U_0}} & A_0 & &
 \end{array}$$

can also be calculated as the pullback of

$$\begin{array}{ccc}
 & & A_1 \\
 & & \downarrow (s,t) \\
 \underline{V} \times A_0 & \xrightarrow{(\Sigma_U)_0 \times \text{id}} & A_0 \times A_0
 \end{array}$$

However, since the map (s, t) factors through $A_0 \times_U A_0$, we find that the following diagram is a pullback

$$(25) \quad \begin{array}{ccc}
 \underline{V} \times_{A_0} A_1 & \longrightarrow & A_1 \\
 \downarrow & & \downarrow (s,t) \\
 \underline{V} \times_U A_0 & \xrightarrow{(\Sigma_U)_0 \times \text{id}} & A_0 \times_U A_0
 \end{array}$$

The projection map $\underline{V} \times_U A_0 \rightarrow A_0$ is an open cover, since \underline{V} is an open cover of U . As $A_1 \rightarrow A_0 \times_U A_0$ admits local sections over its image (it is the restriction of $B_2 \rightarrow B_1 \times_{B_0} B_1$ to a subspace) there is an open cover $W \rightarrow \text{im}(s, t)$ and a map η as in the diagram:

$$\begin{array}{ccc}
 W & \xrightarrow{\eta} & A_1 \\
 \downarrow & & \downarrow (s,t) \\
 \text{im}(s, t) & \hookrightarrow & A_0 \times_U A_0
 \end{array}$$

We then claim that the composite down the left of the diagram

$$\begin{array}{ccc}
\underline{V} \times_U A_0 \times_{A_0 \times_U A_0} W & \longrightarrow & W \\
\downarrow & & \downarrow \\
\underline{V} \times_U A_0 & \longrightarrow & A_0 \times_U A_0 \\
\downarrow & & \downarrow \\
A_0 & & \text{im}(s, t) \\
& & \downarrow \\
& & A_0 \times_U A_0
\end{array}$$

is an open cover of A_0 . The space in the top left corner is certainly the disjoint union of *some* collection of open sets of A_0 , but to see that every $a \in A_0$ is contained within an open set in this collection, we point out that given a there is an anasection (V_σ, σ) such that $a \xrightarrow{\mu} \sigma(v)$ for some $v \in V_\sigma$. Thus $(\sigma(v), a) \in \text{im}(s, t)$, so there is a $w \in W$ over $(\sigma(v), a)$, and a (v, a, w) sitting over a . We then get a diagram

$$\begin{array}{ccccc}
\underline{V} \times_U A_0 \times_{A_0 \times_U A_0} W & \longrightarrow & W & \xrightarrow{\lambda} & A_1 \\
\downarrow & & & & \downarrow \\
\underline{V} \times_U A_0 & \longrightarrow & & & A_0 \times_U A_0
\end{array}$$

and the universal property of the pullback (25) ensures we have a map

$$\underline{V} \times_U A_0 \times_{A_0 \times_U A_0} W \rightarrow \underline{V} \times_{A_0} A_1,$$

which guarantees that Σ_U is essentially \mathcal{O} -surjective. \square

As a corollary we see that Σ_U is essentially \mathcal{O} -surjective for locally weakly discrete submersive groupoids.

PROPOSITION 5.48. *For B a locally weakly discrete submersive bigroupoid, the canonical functor Σ_U is fully faithful for 1-connected U .*

Proof. Using the notation from the previous proof, we need to show that

$$\begin{array}{ccc}
\coprod_{\lambda: \sigma \rightarrow \sigma' \in \Gamma} V_\sigma \times_U V_{\sigma'} & \longrightarrow & A_1 \\
\downarrow & & \downarrow \\
\overline{V} \times_U \overline{V} & \xrightarrow{(\Sigma_U)_0^2} & A_0 \times_U A_0
\end{array}$$

is a pullback square. Since $\bar{V} \times_U \bar{V} \simeq \coprod_{\sigma, \sigma'} V_\sigma \times_U V_{\sigma'}$, this will follow if we show that

$$\begin{array}{ccc} \coprod_{\lambda \in \Gamma(\sigma, \sigma')} V_\sigma \times_U V_{\sigma'} & \longrightarrow & A_1 \\ \downarrow & & \downarrow \\ V_\sigma \times_U V_{\sigma'} & \xrightarrow{\sigma_0 \times \sigma'_0} & A_0 \times_U A_0 \end{array}$$

is a pullback for each pair $\sigma, \sigma' \in \Gamma_0$. Each transformation $\lambda \in \Gamma(\sigma, \sigma')$ determines a lift of $\sigma_0 \times \sigma'_0$

$$\begin{array}{ccc} & & A_1 \\ & \nearrow \lambda & \downarrow \\ V_\sigma \times_U V_{\sigma'} & \xrightarrow{\sigma_0 \times \sigma'_0} & A_0 \times_U A_0 \end{array}$$

or equivalently a section

$$\begin{array}{c} (V_\sigma \times_U V_{\sigma'}) \times_{A_0 \times_U A_0} A_1 \\ \downarrow \bar{\lambda} \\ V_\sigma \times_U V_{\sigma'} \end{array}$$

Consider a pair of transformations $\lambda, \lambda': \sigma \rightarrow \sigma'$ such that there is a $(v, v') \in V_\sigma \times_U V_{\sigma'}$ with $\lambda_{(v, v')} = \lambda'_{(v, v')}$. As $A_1 \rightarrow A_0 \times_U A_0$ is a covering space, this implies that λ and λ' agree on the component of $V_\sigma \times_U V_{\sigma'}$ containing (v, v') . To extend this to other components, we use the fact U is path-connected. Choose from each component $(V_\sigma \times_U V_{\sigma'})_\beta$ a point (v_β, v'_β) , and a path $\gamma: I \rightarrow U$ from the image of (v, v') to the image of (v_β, v'_β) . There is a partition groupoid \mathfrak{p} and a lift $\hat{\gamma}$

$$\begin{array}{ccc} \mathfrak{p} & \xrightarrow{\hat{\gamma}} & \check{C}(V_\sigma \times_U V_{\sigma'}) \\ \downarrow & & \downarrow \\ I & \xrightarrow{\gamma} & U \end{array}$$

The functors

$$\sigma[V_\sigma \times_U V_{\sigma'}], \sigma'[V_\sigma \times_U V_{\sigma'}]: \check{C}(V_\sigma \times_U V_{\sigma'}) \rightarrow A$$

together with the path $\hat{\gamma}$ give us a pair of paths $\mathfrak{p} \rightarrow A$, and the transformations λ, λ' gives transformations $\mu := \lambda[\mathfrak{p}], \mu' := \lambda'[\mathfrak{p}]$ between them. We have seen that

these transformations agree on the initial region $[0, t_1^-]$ of \mathfrak{p} , and naturality implies that $\mu_{t_1^+} = \mu'_{t_1^+}$. Uniqueness of path lifting for the covering space $A_1 \rightarrow A_0 \times_U A_0$ then implies that μ and μ' agree on the next region $[t_1^+, t_2^-]$ of \mathfrak{p} . Continuing in this way we find that $\mu_1 = \mu'_1$, and therefore λ and λ agree at (v_β, v'_β) , and thus on the whole component $(V_\sigma \times_U V_{\sigma'})_\beta$. Since λ and λ agree on all of $V_\sigma \times_U V_{\sigma'}$, we have $\lambda = \lambda'$. Thus the images of $V_\sigma \times_U V_{\sigma'}$ using the sections $\bar{\lambda}$ either coincide or are disjoint, implying that Σ_U is faithful.

REMARK 5.49. To save us some space, we recall the notation $A^{[2]} := A \times_B A$ for a map of spaces $A \rightarrow B$.

The data of a natural transformation between a pair of anasections $(V_\sigma, \sigma), (V_{\sigma'}, \sigma')$ is a map λ ,

$$\begin{array}{ccc} & & A_1 \\ & \nearrow \lambda & \downarrow \\ V_{\sigma\sigma'} & \xrightarrow{(\sigma, \sigma')} & A_0^{[2]} \end{array}$$

where we have defined $V_{\sigma\sigma'} = V_\sigma \times_U V_{\sigma'}$.

The functor Σ_U will be fully faithful when, for all $\sigma, \sigma' \in \Gamma_0$, the pulled back covering space in the diagram

$$\begin{array}{ccc} \coprod_{\Gamma(\sigma, \sigma')} V_{\sigma\sigma'} \times_{A_0^{[2]}} A_1 & \longrightarrow & A_1 \\ \downarrow & & \downarrow (s, t) \\ V_{\sigma\sigma'} & \xrightarrow{\sigma_0 \times \sigma'_0} & A_0^{[2]} \end{array}$$

is trivial, with fibre $\Gamma(\sigma, \sigma')$. We know that there is an injection $\Gamma(\sigma, \sigma') \hookrightarrow F$ for any given fibre, because Σ_U is faithful. To construct an inverse to this inclusion, we will initially focus on anasections (V_σ, σ) of a certain sort.

Since $A_1 \rightarrow A_0 \times_U A_0$ is a covering space, there is a trivialising cover of $A_0^{[2]}$ consisting of basic open sets, $S_1 \times_U S_2$. Because of the symmetry provided by the inversion map on arrows, we know that if A_1 trivialises over $S_1 \times_U S_2$, then it trivialises over $S_2 \times_U S_1$. We can thus consider the open cover

$$O \times_U O \rightarrow A_0 \times_U A_0$$

where $O \rightarrow A_0$ is an open cover consisting of basic open sets. Let us for now only consider those anasections (V, σ) such that $V \xrightarrow{\sigma} A_0$ factors through O . Then for

such a pair of anasections, we know that there is a lift in the diagram

$$\begin{array}{ccc}
 & & O \times_U O \\
 & \nearrow \text{dashed} & \downarrow \\
 V_{\sigma\sigma'} & \xrightarrow{\sigma_0 \times \sigma'_0} & A_0^{[2]}
 \end{array}$$

We now claim that if there is point $(v, v') \in V_{\sigma\sigma'}$ such that $\sigma(v) \stackrel{\alpha_0}{\cong} \sigma'(v')$ in A , $\sigma_0 \times \sigma'_0$ factors through $\text{im}(s, t)$. To see this is the case, given (v, v') , if (w, w') is any other point in $V_{\sigma\sigma'}$, choose a path $\gamma: \mathbf{p} \rightarrow \check{C}(V_{\sigma\sigma'})$ from (v, v') to (w, w') (possible as U is 0-connected). Then the object components of the paths

$$\sigma \circ \gamma: \mathbf{p} \rightarrow A, \quad \sigma' \circ \gamma: \mathbf{p} \rightarrow A$$

define a map $\mathbf{p} \rightarrow A_0^{[2]}$. By unique path lifting for covering spaces, we can lift the path $[0, t_1^-] \rightarrow A_0^{[2]}$ to a path $\tilde{\gamma}_1: [0, t_1^-] \rightarrow A_1$ starting at α_0 . The arrow components of $\sigma \circ \gamma$ and $\sigma' \circ \gamma$ give us the two horizontal arrows in the square

$$(26) \quad \begin{array}{ccc}
 \sigma \circ \gamma(t_1^-) & \xrightarrow{\sigma \circ \gamma(t_1^-, t_1^+)} & \sigma \circ \gamma(t_1^+) \\
 \downarrow \tilde{\gamma}_1(t_1^-) & & \downarrow \alpha_1 \\
 \sigma' \circ \gamma(t_1^-) & \xrightarrow{\sigma' \circ \gamma(t_1^-, t_1^+)} & \sigma' \circ \gamma(t_1^+)
 \end{array}$$

which defines the arrow α_1 . This process obviously repeats until we get to a path in A_1 covering the segment $[t_n^+, 1] \rightarrow A_0^{[2]}$, so that $(w, w') \in \text{im}(s, t)$. We will use this method to define a transformation between anasections. Note that the process just outlined did not depend on the details of $V_{\sigma\sigma'}$ beyond the fact it was an open cover of a path-connected space. We are therefore free to replace $V_{\sigma\sigma'} \rightarrow U$ by any cover $W \rightarrow U$ if necessary.

Let σ, σ' be anasections such that there is a $v_0 = (v, v') \in V_{\sigma\sigma'}$ with $\sigma(v) \stackrel{\lambda_0}{\cong} \sigma'(v')$. Choose for each component $V_\beta \subset V_{\sigma\sigma'}$ a basepoint v^β , and a path γ_β from v_0 to v^β . By the method outlined, we can find arrows $\lambda_\beta: \sigma(v^\beta) \rightarrow \sigma'(v^\beta)$. As the map $V_{\sigma\sigma'} \rightarrow A_0^{[2]}$ factors through a trivialising cover, we can lift each component V_β to A_1 in a way that agree with the arrows λ_β . It is clear that this does not depend on the choice of $v^\beta \in V_\beta$, however, it is not obvious that this lift is independent of the choice of path γ_β .

Let $\gamma'_\beta: \mathbf{p}' \rightarrow \check{C}(V_{\sigma\sigma'})$ be any other path from v_0 to v^β , and denote the arrow in A derived using this path by λ'_β . Since U is 1-connected, so is $\check{C}(V_{\sigma\sigma'})$, and we can find a surface in $\check{C}(V_{\sigma\sigma'})$ between γ_β and γ'_β . We will choose this surface to be collared (see definition 2.71). Such a surface is specified by a sequence of

alternating homotopies $[t_i, t_{i+1}] \times \mathfrak{q} \rightarrow \check{C}(V_{\sigma\sigma'})$ and natural transformations between paths $\mathfrak{q} \rightarrow \check{C}(V_{\sigma\sigma'})$, together with the common refinement $\mathfrak{q} := \mathfrak{p}\mathfrak{p}'$. Now the paths $\mathfrak{q} \rightarrow \mathfrak{p} \rightarrow A$ (defined using σ and σ') determine the same arrow $\lambda_\beta \in A_1$ as the original paths with domain \mathfrak{p} , and similarly for λ'_β . We then only need to consider the regular part of the surface, $\mathfrak{q}' \times \mathfrak{q}$.

Assume that we have a surface $f: I \times \mathfrak{q} \rightarrow \check{C}(V_{\sigma\sigma'})$ between γ_β and γ'_β . By definition, the path $f(-, 0)$ is constant at w_0 , and $f(-, 1)$ is constant at v^β . The object components σ_0, σ'_0 give us a map $I \times [0, t_1^-] \rightarrow A_0^{[2]}$ which then determines the a unique lift in

$$\begin{array}{ccc} I & \xrightarrow{\quad} & * \xrightarrow{a} A_1 \\ \downarrow & \nearrow \tilde{f}_1 & \downarrow (s,t) \\ I \times [0, t_1^-] & \xrightarrow{\quad} & A_0^{[2]} \end{array}$$

The path $\tilde{f}_1(-, t_1^-): I \rightarrow A_1$ then fits into a commutative square of paths

$$\begin{array}{ccc} \sigma \circ f(-, t_1^-) & \xrightarrow{\sigma \circ f(-; t_1^-, t_1^+)} & \sigma \circ f(-, t_1^+) \\ \downarrow \tilde{f}_1(-, t_1^-) & & \downarrow \tilde{f}_2(-, t_1^+) \\ \sigma' \circ f(-, t_1^-) & \xrightarrow{\sigma' \circ f(-; t_1^-, t_1^+)} & \sigma' \circ f(-, t_1^+) \end{array}$$

which defines the path $\tilde{f}_2(-, t_1^+): I \rightarrow A_1$. This process repeats, in that we can now find a unique lift in the square

$$\begin{array}{ccc} I & \xrightarrow{\tilde{f}_2(-, t_1^+)} & A_1 \\ \downarrow & \nearrow \tilde{f}_2 & \downarrow (s,t) \\ I \times [t_1^+, t_2^-] & \xrightarrow{\quad} & A_0^{[2]} \end{array}$$

and so on until we lift the homotopy $I \times [t_n^+, 1] \rightarrow A_0^{[2]}$ to A_1 . Notice that this lift evaluated on $(0, 1)$ and $(1, 1)$ gives λ_β and λ'_β respectively, but since the path $I \times \{1\} \rightarrow A^{[2]}$ is constant, it lifts to a constant path from λ_β to λ'_β , so they are equal.

Now assume we have a natural transformation $\tau: \gamma \Rightarrow \gamma': \mathbf{q} \rightarrow \check{C}(V_{\sigma\sigma'})$ where $\tau = \text{id}_{v_0}$ and $\tau_1 = \text{id}_{v_\beta}$. This gives us a commuting square of paths $[0, t_1^-] \rightarrow A_1$:

$$\begin{array}{ccc} \sigma \circ \gamma(-) & \xrightarrow{\tilde{\gamma}_1(-)} & \sigma' \circ \gamma(-) \\ \downarrow \sigma_1 \circ \tau(-) & & \downarrow \sigma'_1 \circ \tau(-) \\ \sigma \circ \gamma'(-) & \xrightarrow{\tilde{\gamma}'_1(-)} & \sigma' \circ \gamma'(-) \end{array}$$

as we know this commutes when evaluated at 0, and we use uniqueness of path lifting for the two composites from the top left to the bottom right.

If we evaluate this at t_1^- , combine it with naturality squares for τ and the squares (26) for both γ_1 and γ'_1 , we get a cube

$$\begin{array}{ccccc} \sigma \circ \gamma(t_1^-) & \xrightarrow{\tilde{\gamma}_1(t_1^-)} & \sigma' \circ \gamma(t_1^-) & & \\ \downarrow \sigma_1 \circ \tau(t_1^-) & \searrow \sigma \circ \gamma(t_1^-, t_1^+) & \downarrow \sigma'_1 \circ \tau(t_1^-) & \searrow \sigma' \circ \gamma(t_1^-, t_1^+) & \\ \sigma \circ \gamma(t_1^+) & \xrightarrow{\tilde{\gamma}_1(t_1^+)} & \sigma' \circ \gamma(t_1^+) & & \\ \downarrow \sigma_1 \circ \tau(t_1^+) & \searrow \sigma \circ \gamma'(t_1^-, t_1^+) & \downarrow \sigma'_1 \circ \tau(t_1^+) & \searrow \sigma' \circ \gamma'(t_1^-, t_1^+) & \\ \sigma \circ \gamma'(t_1^-) & \xrightarrow{\tilde{\gamma}'_1(t_1^-)} & \sigma' \circ \gamma'(t_1^-) & & \\ \downarrow \sigma_1 \circ \tau(t_1^-) & \searrow \sigma \circ \gamma'(t_1^-, t_1^+) & \downarrow \sigma'_1 \circ \tau(t_1^-) & \searrow \sigma' \circ \gamma'(t_1^-, t_1^+) & \\ \sigma \circ \gamma'(t_1^+) & \xrightarrow{\tilde{\gamma}'_1(t_1^+)} & \sigma' \circ \gamma'(t_1^+) & & \end{array}$$

We thus get another commuting square of paths $[t_1^+, t_2^-] \rightarrow A_1$, again using uniqueness of path lifting. This continues until we get to a commuting square

$$\begin{array}{ccc} \sigma \circ \gamma(1) & \xrightarrow{\tilde{\gamma}_{n+1}(1)} & \sigma' \circ \gamma(1) \\ \downarrow \sigma_1 \circ \tau(1) & & \downarrow \sigma'_1 \circ \tau(1) \\ \sigma \circ \gamma'(1) & \xrightarrow{\tilde{\gamma}'_{n+1}(1)} & \sigma' \circ \gamma'(1) \end{array}$$

where now $\tilde{\gamma}_{n+1}(1) = \lambda_\beta$ and $\tilde{\gamma}'_{n+1}(1) = \lambda'_\beta$. Since $\tau_1 = \text{id}_{v_\beta}$, we see that $\lambda_\beta = \lambda'_\beta$. Thus given a surface from γ_β to γ'_β we find that λ_β is independent of the path γ_β chosen.

Since $\sigma_0 \times \sigma'_0: V_{\sigma\sigma'} \rightarrow A_0^{[2]}$ factors through a trivialising cover for A_1 , we can lift this to A_1 component by component. We shall do this such that the map

$\lambda|_{V_\beta} : V_\beta \rightarrow A_1$ sends v^β to $\lambda_{v,\beta}$. This gives us a map λ :

$$\begin{array}{ccc} & & A_1 \\ & \nearrow \lambda & \downarrow (s,t) \\ V_{\sigma\sigma'} & \xrightarrow{\sigma_0 \times \sigma'_0} & A_0^{[2]} \end{array}$$

which is a candidate to be the component map of a natural transformation.

Let V_{β_1}, V_{β_2} be a pair of components of $V_{\sigma\sigma'}$ such that $V_{\beta_1} \times_U V_{\beta_2}$ is non-empty. For any component $V_{\beta_1\beta_2}^\kappa$ of this pullback, let $\eta : \mathfrak{d} \rightarrow \check{C}(V_{\beta_1} \amalg V_{\beta_2})$ be a path⁵ from v^{β_1} to v^{β_2} passing through $V_{\beta_1\beta_2}^\kappa$, such that $\eta(t)$ is constant for $t \in [\frac{1}{2}^+, \frac{1}{2} + \epsilon]$. Let $v_- := \eta(\frac{1}{2}^-)$ and $v_+ = \eta(\frac{1}{2}^+)$. We can paste the paths $\eta|_{[0, \frac{1}{2} + \epsilon]}$, $\eta|_{[\frac{1}{2}^+, 1]}$ with γ_{β_1} and γ_{β_2} respectively to get a pair of paths to v_+ . By the arguments leading to the independence of the component of the natural transformation at v_+ on the path chosen, we necessarily have a commutative square

$$\begin{array}{ccc} \sigma(v_-) & \xrightarrow{\tau_{v_-}} & \sigma'(v_-) \\ \downarrow \sigma(v_-, v_+) & & \downarrow \sigma'(v_-, v_+) \\ \sigma(v_+) & \xrightarrow{\tau_{v_+}} & \sigma'(v_+) \end{array}$$

and since we have chosen this intersection arbitrarily, we have the result that λ is natural.

Notice that if we had a different λ_0 to begin with, say λ'_0 , then the natural transformation it gives rise to would nowhere agree with the one just constructed, otherwise by the first half of the proof they would agree everywhere, and $\lambda_0 = \lambda'_0$. Likewise, if we had started with a different v_0 , say v'_0 and isomorphism $\sigma(v'_0) \simeq \sigma'(v'_0)$, we could compare the two transformations: if they agree at v'_0 then they are equal, otherwise they nowhere agree. Thus, given a point $(v_0, \lambda_0) \in V_{\sigma\sigma'} \times_{A_0^{[2]}} A_1$ where $V_\sigma, V_{\sigma'}$ are fine enough so as to factor through $O \rightarrow A_0$, we have a section

$$V_{\sigma\sigma'} \rightarrow V_{\sigma\sigma'} \times_{A_0^{[2]}} A_1$$

of the projection, and for each λ_0 in the fibre over v_0 we have pairwise disjoint sections, corresponding one-to-one with transformations $\sigma \rightarrow \sigma'$. Thus $V_{\sigma\sigma'} \times_{A_0^{[2]}} A_1 \rightarrow V_{\sigma\sigma'}$ is a trivial covering space with fibre $\Gamma(\sigma, \sigma')$.

Now if V_σ does *not* factor through $O \rightarrow A_0$, there is an anasection

$$\sigma_O : V_\sigma \times_{A_0} O \rightarrow V_\sigma \rightarrow A_0$$

⁵Recall that the partition groupoid \mathfrak{d} is given by $\{\frac{1}{2}\}$.

which does, and there is a canonical transformation $\sigma_O \rightarrow \sigma$. Thus given any anasections $(V_\sigma, \sigma), (V_{\sigma'}, \sigma')$ such that there is an isomorphism $\lambda_v: \sigma(v) \xrightarrow{\cong} \sigma'(v)$ for $v \in V_{\sigma\sigma'}$, we can define a transformation $\sigma_O \rightarrow \sigma'_O$. We then compose with the canonical transformations to get a transformation $\sigma \rightarrow \sigma'$. This is uniquely determined by a , as before, so for all anasections $(V_\sigma, \sigma), (V_{\sigma'}, \sigma')$ we have the result that

$$\begin{array}{ccc} \coprod_{\Gamma(\sigma, \sigma')} V_{\sigma\sigma'} \times_{A_0^{[2]}} A_1 & \longrightarrow & A_1 \\ \downarrow & & \downarrow (s, t) \\ V_{\sigma\sigma'} & \xrightarrow{\sigma_0 \times \sigma'_0} & A_0^{[2]} \end{array}$$

is a pullback, as desired. \square

We call a topological bigroupoid B *transitive* if the map $B_1 \rightarrow B_0 \times B_0$ is surjective, in analogy with the case of groupoids. The assumption of transitivity is not particularly necessary in the following proposition, as 2-covering spaces do not necessarily map surjectively onto the base space, but this will be the case of interest.

PROPOSITION 5.50. *If B is a transitive, locally weakly discrete submersive bigroupoid with locally 1-connected object space B_0 , then for any $b \in B_0$, the source fibre with its canonical projection functor, $S^{-1}(b) \rightarrow B_0$, is a 2-covering space.*

Proof. If we take a cover of B_0 by path-connected open sets U_α , the functors Σ_{U_α} are local trivialisations of $S^{-1}(b) \rightarrow B_0$, by the previous two lemmas. The fibres are equivalent to the groupoid underlying the 2-group $B(b, b)$ \square

We now use this proposition to show the canonical 2-connected cover, under an additional assumption, is a 2-covering space. Let \mathbf{Top}_*^c denote the full category of \mathbf{Top}_* consisting of the connected, 2-well-connected, locally contractible spaces, and $2Cov_*$ denote the bicategory with objects pointed 2-covering spaces $(Z, z) \rightarrow (X, x)$, 1-arrows the squares

$$\begin{array}{ccc} (Z, z) & \xrightarrow{(f, \alpha)} & (Z', z') \\ \downarrow & & \downarrow \\ \text{disc}(X, x) & \xrightarrow{f} & \text{disc}(Y, y) \end{array}$$

and 2-arrows pointed transformations between anafunctors that cover the identity transformation on f . This is a full sub-bicategory of $\mathbf{Ana}_*/\mathbf{Top}_*$ with objects the 2-covering spaces.

THEOREM 5.51. *Let X be a connected, 2-well-connected, locally contractible space. The canonical 2-connected cover $X^{(2)} \rightarrow X$ is a 2-covering space, and this construction gives a functor*

$$\mathbf{Top}_*^c \rightarrow 2Cov_*$$

Proof. We have a functor $\mathbf{Top}_*^c \rightarrow \mathbf{Ana}_*/\mathbf{Top}_*$ from the discussion following theorem 5.39, we only need to show that it lands in $2Cov_*$. We know from lemma 5.27 that $\Pi_2^T(X)$ is locally weakly discrete. We just need to show that $\Pi_2^T(X)$ is a submersive bigroupoid, and then the result will follow from proposition 5.50.

Let x_0 be any point in X and let $\gamma \in P_{x_0}X$. Let U be a neighbourhood of $x_1 := \gamma(1)$ such that $U \hookrightarrow X$ is null-homotopic. Then the map $P_{x_1}X \rightarrow X$ admits a local section $s: U \rightarrow P_{x_1}X$, which we claim can be chosen such that $\lambda := s(x_1)$, which is a loop in X , is null-homotopic. If this is not the case, compose the section with the map $P_{x_1}X \rightarrow P_{x_1}X$ given by preconcatenation with $\bar{\lambda}$, then the new section sends x_1 to $\lambda \cdot \bar{\lambda}$, which is null-homotopic. We then compose the section s with the map $P_{x_1}X \rightarrow P_{x_0}X$ which is preconcatenation with γ to get a section s' . Since $s'(x_1) = \lambda \cdot \gamma$, which is homotopic to γ rel endpoints, we have an anasection

$$\text{disc}(U) \stackrel{\cong}{\leftarrow} \text{disc}(U) \xrightarrow{s'} S^{-1}(x_0),$$

such that γ is isomorphic to an object in the image of s' . Thus $\Pi_2^T(X)$ is a submersive groupoid and $X^{(2)} = S^{-1}(x)$ is a 2-covering space. \square

A preliminary version of this theorem was in fact the original insight that engendered the theory of 2-covering spaces.

REMARK 5.52. In the theory of covering spaces, the condition on a space we here call 1-well-connectedness is necessary and sufficient for the existence of a 1-connected covering space. In contrast, given the definition of 2-covering space in this thesis, 2-well-connectedness is necessary but not sufficient. This deficiency arises because on \mathbf{Top} the pretopology \mathcal{O} of open covers is not equivalent to the pretopology os of open surjections, unless attention is restricted to full subcategories such as that of CW-complexes (it is a nice exercise to see that every open surjection of CW-complexes admits local sections, implying that $\mathcal{O} < os$).

One possible solution is to define 2-covering spaces using the localisation $TG[W_{os}^{-1}]$, as then the canonical 2-connected cover is not precluded from being a 2-covering space – the fibration $P_x X \rightarrow X$ being an open surjection for connected, locally path-connected X . Since $\mathcal{O} \subset os$ all the 2-covering spaces we have considered here would still be 2-covering spaces. The pretopology os is rather nice as open surjections are effective descent maps [Moe89], and have links to topos theory. However, in this case it is not clear that the link between weakly discrete groupoids (once interpreted in $TG[W_{os}^{-1}]$) and 1-types is preserved. One way around this may be to consider localic groupoids, i.e. groupoids internal to the category of locales.

This does raise the question of using other pretopologies in defining 2-covering spaces (and indeed other topological structures), chosen to be optimal for the problem at hand. A similar situation arises in algebraic geometry where there is a greater sensitivity to the pretopology chosen, and indeed this was the reason Grothendieck introduced pretopologies on categories to begin with.

5. Vertical fundamental groupoid

One conceptually clear way to get a bundle of groupoids is to take an ordinary bundle (of some sort) in **Top** and apply a fibrewise fundamental groupoid functor. If the fibres are 1-well-connected, the fundamental groupoid is weakly discrete, and this is what we require of the fibres of our 2-covering spaces. The only issue is how to do this construction in TG , as opposed to **Gpd**. We shall do this in the case that the bundle is locally trivial. In this instance, the appropriate notion of homotopy is *vertical* homotopy.

DEFINITION 5.53. Given spaces $E_1 \rightarrow X$, $E_2 \rightarrow X$ and maps $f, g: E_1 \rightarrow E_2$ over X , a *vertical homotopy* from f to g is a map $h: E_1 \times I \rightarrow E_2$ over X such that $h(-, 0) = f$ and $h(-, 1) = g$. We then say f and g are *vertically homotopic*.

We can compose vertical homotopies, so that if f is vertically homotopic to g and g is vertically homotopic to h , f is vertically homotopic to h .

DEFINITION 5.54. Given a space $p: E \rightarrow X$ over X , a *vertical path* is a path $\gamma: I \rightarrow E$ such that $p \circ \gamma$ is a constant path in X . We define $vert(I, E) \subset C(I, E)$ to be the subset of vertical paths.

We now fix a space $p: E \rightarrow X$ over X such that the fibres $p^{-1}(x)$ are all 1-well-connected. Denote by \sim_v the equivalence relation ‘vertically homotopic rel endpoints’ on $vert(I, E)$. Then

DEFINITION 5.55. There is a t-d groupoid $\Pi_1^{\mathcal{V}}(E)$ with objects E^δ and arrows $vert(I, E)/\sim_v$ called the *vertical fundamental groupoid*. Composition is induced by concatenation of paths, identities are constant paths and the inverse of an arrow represented by a path is the reverse path. There is a functor $p_*: \Pi_1^{\mathcal{V}}(E) \rightarrow \text{disc}(X)$ induced by p .

The fibre of p_* at x is the fundamental groupoid $\Pi_1(p^{-1}(x))$, and we have an isomorphism of t-d groupoids

$$\Pi_1^{\mathcal{V}}(E) \simeq \coprod_{x \in X} \Pi_1(p^{-1}(x)).$$

Note however that we are interested in topologising the vertical fundamental groupoid, and this isomorphism will not carry over to one in TG . A result that will carry over to TG is that $\Pi_1^{\mathcal{V}}$ commutes with coproducts, in that given two spaces E_1, E_2 over X , we have $\Pi_1^{\mathcal{V}}(E_1 \coprod E_2) \simeq \Pi_1^{\mathcal{V}}(E_1) \coprod \Pi_1^{\mathcal{V}}(E_2)$.

There is a canonical comparison functor $\Pi_1^{\mathcal{V}}(E) \rightarrow \Pi_1(E)$ (in **Gpd**), but this is neither faithful nor full in general. For an example of when this is not faithful, let $E = P_x X$ (for some basepoint $x \in X$) which is contractible, but the fibres are homotopy equivalent to ΩX , which is not necessarily connected or 1-connected. For a non-full example, let $\tilde{X} \rightarrow X$ be a path-connected covering space, so that $\Pi_1^{\mathcal{V}}(\tilde{X}) = \text{disc}(\tilde{X}^\delta)$ but $\Pi_1(\tilde{X})$ is transitive.

Given a map $f: E_1 \rightarrow E_2$ of spaces over X , we get an induced functor $f_*: \Pi_1^{\mathcal{V}}(E_1) \rightarrow \Pi_1^{\mathcal{V}}(E_2)$ by post-composing with f . Thus we have a functor

$$\Pi_1^{\mathcal{V}}: \mathbf{Top}/X \rightarrow \mathbf{Gpd}/\text{disc}(X^\delta).$$

For the next result, recall the functor $g^*: \mathbf{Top}/Y \rightarrow \mathbf{Top}/X$ arising from a map $g: X \rightarrow Y$, given by pulling back spaces over Y to spaces over X . There are analogous functors

$$\begin{aligned} f^* &: \mathbf{Gpd}/\text{disc}(B) \rightarrow \mathbf{Gpd}/\text{disc}(A) \\ g^* &: TG/\text{disc}(Y) \rightarrow TG/\text{disc}(X) \end{aligned}$$

where $f: A \rightarrow B \in \mathbf{Set}$.

PROPOSITION 5.56. *For a map $g: X \rightarrow Y$ of spaces, we have a square*

$$\begin{array}{ccc} \mathbf{Top}/Y & \xrightarrow{g^*} & \mathbf{Top}/X \\ \Pi_1^{\mathcal{Y}} \downarrow & & \downarrow \Pi_1^{\mathcal{Y}} \\ \mathbf{Gpd}/\text{disc}(Y^\delta) & \xrightarrow{g^*} & \mathbf{Gpd}/\text{disc}(X^\delta) \end{array}$$

where the component of the natural transformation are given by the canonical isomorphisms

$$\Pi_1^{\mathcal{Y}}(X \times_Y E) \rightarrow \text{disc}(X^\delta) \times_{\text{disc}(Y^\delta)} \Pi_1^{\mathcal{Y}}(E).$$

Once we have placed a topology on $\Pi_1^{\mathcal{Y}}(E)$ for a $E \rightarrow X$ in a subcategory of \mathbf{Top}/X , we get an analogous square for topological groupoids. This will allow us to consider the local behaviour of the bundle of groupoids $\Pi_1^{\mathcal{Y}}(E) \rightarrow \text{disc}(X^\delta)$. As one might expect, if the space E is a product $F \times X$ and $p: E \rightarrow X$ is projection on the second factor, the vertical fundamental groupoid only ‘sees’ the space F . Recall the functor $\mathbf{Top} \xrightarrow{- \times X} \mathbf{Top}/X$ sending $F \mapsto F \times X$, and the analogous functor $\mathbf{Gpd} \xrightarrow{- \times G} \mathbf{Gpd}/G$ for a t-d groupoid G .

PROPOSITION 5.57. *Given a space X , we have a square*

$$\begin{array}{ccc} \mathbf{Top} & \xrightarrow{- \times X} & \mathbf{Top}/X \\ \Pi_1 \downarrow & & \downarrow \Pi_1^{\mathcal{Y}} \\ \mathbf{Gpd} & \xrightarrow{- \times \text{disc}(X^\delta)} & \mathbf{Gpd}/\text{disc}(X^\delta) \end{array}$$

Taking these two propositions together, we can see that if $E \rightarrow X$ is a locally trivial bundle, the bundle of t-d groupoids $\Pi_1^{\mathcal{Y}}(E) \rightarrow X$ is locally trivial in a way compatible with the local trivialisations. We can thus use the local trivialisations to topologise $\Pi_1^{\mathcal{Y}}(E)$. In fact, as the set of objects of the vertical fundamental groupoid is just the underlying set of E , we only need to come up with a topology on the arrows of $\Pi_1^{\mathcal{Y}}(E)$.

PROPOSITION 5.58. *If $p: E \rightarrow X$ is a locally trivial bundle with 1-well-connected fibre, $\Pi_1^{\mathcal{Y}}(E)$ is a topological groupoid.*

Proof. We know the set of objects will just be the space E , it just remains to construct the space $\Pi_1^{\mathcal{Y}}(E)$. Let $U = \coprod_{\alpha} U_{\alpha} \rightarrow X$ be a trivialising cover with isomorphisms

$$\phi_{\alpha} U_{\alpha} \times F \xrightarrow{\sim} U_{\alpha} \times_X E =: E_{U_{\alpha}}.$$

There are then isomorphisms of t-d groupoids $\text{disc}(U_{\alpha}^{\delta}) \times \Pi_1(F) \rightarrow \Pi_1^{\mathcal{Y}}(E_{U_{\alpha}})$ which we use to put a topology on $\Pi_1^{\mathcal{Y}}(E_{U_{\alpha}})_1$, using the topology on $\Pi_1(F)$ from proposition 5.22. This makes $\Pi_1^{\mathcal{Y}}(E_{U_{\alpha}})$ a topological groupoid. Notice that when we pull back to intersections $U_{\alpha\beta} = U_{\alpha} \cap U_{\beta}$, the transition functions $g_{\alpha\beta} := \phi_{\beta}^{-1} \circ \phi_{\alpha}$ give us isomorphisms of topological groupoids

$$g_{\alpha\beta*}: \Pi_1^{\mathcal{Y}}(E_{U_{\alpha}}) \times_X U_{\beta} \rightarrow \Pi_1^{\mathcal{Y}}(E_{U_{\beta}}) \times_X U_{\alpha}$$

such that $g_{\alpha\alpha*} = \text{id}$, $g_{\alpha\beta*}^{-1} = g_{\beta\alpha*}$ and on restricting to triple intersections $U_{\alpha\beta\gamma}$ we have $g_{\beta\gamma*} \circ g_{\alpha\beta*} = g_{\alpha\gamma*}$.

We can then form the colimit of the diagram given by considering just the arrow spaces $\Pi_1^{\mathcal{Y}}(E_{U_{\alpha}})_1$ and the arrow components of the functors $g_{\alpha\beta*}$. We can do this by placing the identification topology on the set of arrows of the t-d groupoid $\Pi_1^{\mathcal{Y}}(X)$. Recall that we know E is the colimit of the analogous diagram involving object spaces and the object components of the functors $g_{\alpha\beta*}$, which are precisely the transition functions for $E \rightarrow X$. The defining property of the identification topology means that it is an easy exercise to show the structure maps (source, target, unit and composition) for the groupoid $\Pi_1^{\mathcal{Y}}(X)$ with the topology just described are continuous. Moreover, there are isomorphisms of topological groupoids $\Pi_1^{\mathcal{Y}}(X) \times_X U_{\alpha} \simeq \Pi_1(F) \times \text{disc}(U_{\alpha})$ commuting with the projections to U_{α} . \square

PROPOSITION 5.59. *Let $p: E \rightarrow X$ be a locally trivial bundle with 1-well-connected fibre F . Then $\Pi_1^{\mathcal{Y}}(E) \rightarrow X$ is a 2-covering space.*

Proof. The isomorphisms mentioned at the end of the proof of the previous proposition give us local trivialisations, and there is a weak equivalence $\Pi_1(F)^{\delta} \rightarrow \Pi_1(F)$ as F is 1-well-connected (proposition 5.23). \square

We can generalise this to maps where not all the fibres are isomorphic by taking the disjoint union of a set of bundles, $\coprod_i E_i \rightarrow \coprod_i X_i =: X$. Then as $\Pi_1^{\mathcal{Y}}$ commutes with coproducts, we get a 2-covering space $\coprod_i \Pi_1^{\mathcal{Y}}(E_i) \rightarrow X$.

REMARK 5.60. Going down a dimension, we can see there is an analogous construction that takes a bundle and gives a covering space, subject to the hypothesis that the fibre is 0-well-connected. Consider the vertical path space $\text{vert}(E^I)$ of a locally trivial bundle $E \rightarrow B$, and the equivalence relation on E ‘connected by a vertical path’. The quotient can be considered as a ‘fibrewise’ or ‘relative’ π_0 .

REMARK 5.61. We clearly did not use the full flexibility of the definition of 2-covering space, as the local trivialisations were essentially isomorphisms. If we

generalise $E \rightarrow X$ to a locally homotopy trivial fibration, and use the theory of homotopy transition cocycles from [WS06], then a similar result to proposition 5.59 is possible.

APPENDIX A

Bicategories, bigroupoids and 2-groups

We collect here the necessary definitions used in the text.

1. Bicategories

The following is copied/adapted from [Lei98] and [HKK01], themselves a distilling of the original source [Bén67].

DEFINITION A.1. A *bicategory* \mathbf{B} is given by the following data:

- A class¹ \mathbf{B}_0 called the *0-cells* or *objects* of \mathbf{B} ,
- A category \mathbf{B}_1 with a functor

$$(S, T): \mathbf{B}_1 \rightarrow \text{disc}(\mathbf{B}_0) \times \text{disc}(\mathbf{B}_0).$$

The fibre of (S, T) at $(A, B) \in \mathbf{B}_0 \times \mathbf{B}_0$ is denoted $\mathbf{B}(A, B)$ and is called a hom-category. The objects f, g, \dots of \mathbf{B}_1 are called *1-cells*, or *1-arrows*, and the arrows α, β, \dots of \mathbf{B}_1 are called *2-cells*, or *2-arrows*. The functors S, T are the *source* and *target* functors. The composition in \mathbf{B}_1 will be denoted $(\alpha, \beta) \mapsto \alpha \cdot \beta$ where the target of α is the source of β . This is also called *vertical composition*.

- Functors

$$c_{ABC}: \mathbf{B}(B, C) \times \mathbf{B}(A, B) \rightarrow \mathbf{B}(A, C),$$

for each $A, B, C \in \mathbf{B}_0$, called *horizontal composition*, and an element

$$I_A: * \rightarrow \mathbf{B}(A, A).$$

for each $A \in \mathbf{B}_0$, picking out a 1-cell $A \rightarrow A$ called the *weak unit* of A . Horizontal composition is denoted $(w, v) \mapsto w \circ v$ where $T(v) = S(w)$, and v, w are either 1-cells or 2-cells.

- Natural isomorphisms

$$\begin{array}{ccc}
 \mathbf{B}(C, D) \times \mathbf{B}(B, C) \times \mathbf{B}(A, B) & \xrightarrow{\text{id} \times c_{ABC}} & \mathbf{B}(C, D) \times \mathbf{B}(A, C) \\
 \downarrow c_{BCD} \times \text{id} & \nearrow a_{ABCD} & \downarrow c_{ACD} \\
 \mathbf{B}(B, D) \times \mathbf{B}(A, B) & \xrightarrow{c_{ABD}} & \mathbf{B}(A, D)
 \end{array}$$

¹Or possibly large set, depending on your choice of foundations. The bicategories in chapter 1 are generally large, whereas the bicategories in chapter 5 are small, in that they have a set of 2-arrows.

given by invertible 2-cells

$$a_{hgf}: (h \circ g) \circ f \Rightarrow f \circ (g \circ f),$$

for composable $f, g, h \in \text{Obj } \mathbf{B}_1$ and natural isomorphisms

$$\begin{array}{ccc} \mathbf{B}(A, B) \times * & & * \times \mathbf{B}(A, B) \\ \downarrow \text{id} \times I_A & \nearrow r_{AB} \cong & \downarrow I_B \times \text{id} \\ \mathbf{B}(A, B) \times \mathbf{B}(A, A) & \xrightarrow{c_{AAB}} & \mathbf{B}(A, B) \end{array} \quad \begin{array}{ccc} & & \\ & \nearrow l_{AB} \cong & \\ & & \end{array}$$

given by invertible 2-cells

$$r_f: f \circ I_A \Rightarrow f, \quad l_f: I_B \circ f \Rightarrow f.$$

where $A = S(F)$ and $B = T(F)$.

The following diagrams are required to commute:

(27)

$$\begin{array}{ccc} ((k \circ h) \circ g) \circ f & \xrightarrow{a_{khg \circ \text{id}_f}} & (k \circ (h \circ g)) \circ f \\ \swarrow a_{(k \circ h)gf} & & \searrow a_{k(h \circ g)f} \\ (k \circ h) \circ (g \circ f) & & k \circ ((h \circ g) \circ f) \\ \searrow a_{kh(g \circ f)} & & \swarrow \text{id}_k \circ a_{hgf} \\ & k \circ (h \circ (g \circ f)) & \end{array}$$

(28)

$$\begin{array}{ccc} (g \circ I) \circ f & \xrightarrow{a_{gIf}} & g \circ (I \circ f) \\ \searrow r_g \text{id}_f & & \swarrow \text{id}_g l_f \\ & g \circ f & \end{array}$$

If the 2-cells a, l, r are all identity 2-cells, then the bicategory is called a 2-category, or *strict* 2-category for emphasis.

DEFINITION A.2. A *bigroupoid* is a bicategory \mathbf{B} such that \mathbf{B}_1 is a groupoid, and the following additional data for each $A, B \in \mathbf{B}_0$:

- Functors

$$\overline{(-)}: \mathbf{B}(A, B) \rightarrow \mathbf{B}(B, A)$$

- Natural isomorphisms

$$\begin{array}{ccc}
\mathbf{B}(A, B) & \xrightarrow{((\bar{-}), \text{id})} & \mathbf{B}(B, A) \times \mathbf{B}(A, B) & \quad & \mathbf{B}(A, B) & \xrightarrow{(\text{id}, \bar{-})} & \mathbf{B}(A, B) \times \mathbf{B}(B, A) \\
\downarrow & \nearrow e_{AB} & \downarrow c_{ABA} & & \downarrow & \nearrow i_{AB} & \downarrow c_{BAB} \\
* & \xrightarrow{I_A} & \mathbf{B}(A, A) & & * & \xrightarrow{I_B} & \mathbf{B}(B, B)
\end{array}$$

The following diagram is required to commute

$$(29) \quad \begin{array}{ccc}
I \circ f & \xrightarrow{i_f \circ \text{id}_f} & (f \circ \bar{f}) \circ f & \xrightarrow{a_{f\bar{f}f}} & f \circ (\bar{f} \circ f) \\
\downarrow l_f & & & & \downarrow \text{id}_f \circ e_f \\
f & \xrightarrow{r_f^{-1}} & f \circ I & &
\end{array}$$

It is a consequence of the other axioms that the following diagram commutes (e.g. [Bre94])

$$\begin{array}{ccc}
\bar{f} \circ I & \xrightarrow{\text{id}_{\bar{f}} \circ i_f} & \bar{f} \circ (f \circ \bar{f}) & \xrightarrow{a_{\bar{f}f\bar{f}}} & (\bar{f} \circ f) \circ \bar{f} \\
\downarrow r_f & & & & \downarrow e_f \circ \text{id}_{\bar{f}} \\
\bar{f} & \xrightarrow{l_{\bar{f}}^{-1}} & I \circ \bar{f} & &
\end{array}$$

If a bigroupoid \mathbf{B} is a 2-category and i, e are identity 2-cells, then it is called a 2-groupoid. Midway between general bicategories and bigroupoids are those bicategories where all the 2-arrows are invertible.

DEFINITION A.3. For a bicategory \mathbf{B} , if the category \mathbf{B}_1 is a groupoid, then \mathbf{B} is called a *weak (2,1)-category* ([BS10], definition 8), or *locally groupoidal*.

EXAMPLE A.4. The 2-category of groupoids, functors and natural transformations is a (2,1)-category, as all natural transformations are actually natural isomorphisms.

The definition of an equivalence of categories (i.e. objects of the 2-category \mathbf{Cat}) can be mimicked in any bicategory.

DEFINITION A.5. A 1-cell $f: A \rightarrow B$ in a bicategory \mathbf{B} is an *equivalence* if there is a 1-cell $g: B \rightarrow A$ and invertible 2-cells

$$g \circ f \Rightarrow I_A, \quad f \circ g \Rightarrow I_B$$

A morphism between bicategories is not required to preserve all the structure strictly, but *coherently*, that is, up to some specified natural isomorphisms, which themselves have to satisfy some conditions.

DEFINITION A.6. A *weak 2-functor* $F: \mathbf{B} \rightarrow \mathbf{B}'$ between bicategories is given by the following data

- functions $F_0: \mathbf{B}_0 \rightarrow \mathbf{B}'_0$
- functors

$$\begin{array}{ccc} \mathbf{B}_1 & \xrightarrow{F_1} & \mathbf{B}'_1 \\ \downarrow & & \downarrow \\ \mathbf{B}_0 \times \mathbf{B}_0 & \longrightarrow & \mathbf{B}'_0 \times \mathbf{B}'_0 \end{array}$$

over $F_0 \times F_0$. This restricts to functors $F_{AB}: \mathbf{B}(A, B) \rightarrow \mathbf{B}'(FA, FB)$ on hom-categories.

- Natural transformations

$$\begin{array}{ccc} \mathbf{B}(B, C) \times \mathbf{B}(A, B) & \xrightarrow{c_{ABC}} & \mathbf{B}(A, C) \\ \downarrow F_{BC} \times F_{AB} & \nearrow \phi_{ABC} & \downarrow F_{AC} \\ \mathbf{B}'(FB, FC) \times \mathbf{B}'(FA, FB) & \xrightarrow{c'_{FAFBFC}} & \mathbf{B}'(FA, FC) \end{array}$$

and

$$\begin{array}{ccc} * & \xrightarrow{I_A} & \mathbf{B}(A, A) \\ \downarrow & \nearrow \phi_A & \downarrow F_{AB} \\ * & \xrightarrow{I_{FA}} & \mathbf{B}'(FA, FA) \end{array}$$

The following diagrams are required to commute

$$(30) \quad \begin{array}{ccccc} (Fh \circ Fg) \circ Ff & \xrightarrow{\phi \circ 1} & F(h \circ g) \circ Ff & \xrightarrow{\phi} & F((h \circ g) \circ f) \\ \downarrow a'_{FhFgFf} & & & & \downarrow F(a_{hgf}) \\ Fh \circ (Fg \circ Ff) & \xrightarrow{1 \circ \phi} & Fh \circ F(g \circ h) & \xrightarrow{\phi} & F(h \circ (g \circ f)) \end{array}$$

(31)

$$\begin{array}{ccc}
Ff \circ I'_{FA} \xrightarrow{\text{id} \circ \phi} Ff \circ FI_A \xrightarrow{\phi} F(f \circ I_A) & & I'_{FB} \circ Ff \xrightarrow{\phi \circ \text{id}} FI_B \circ Ff \xrightarrow{\phi} F(I_B \circ f) \\
\downarrow r'_{Ff} & & \downarrow l'_{Ff} \\
Ff & \xrightarrow{\text{id}} & Ff \\
& & \downarrow Fl_f \\
& & Ff
\end{array}$$

In [Bén67] this was called a homomorphism, and in other places a pseudofunctor (as in [HKK01], originally in [Gro71] from the special case when \mathbf{B} is a category and $\mathbf{B}' = \mathbf{Cat}$). We reserve the name homomorphism for the special case when the bigroupoids both have only one object, i.e. are 2-groups.

A weak 2-functor $F: \mathbf{B} \rightarrow \mathbf{B}'$ between bigroupoids is assumed to have, in addition to the above data, a natural transformation

$$\begin{array}{ccc}
\mathbf{B}(A, B) & \xrightarrow{\overline{(-)}} & \mathbf{B}(B, A) \\
\downarrow F_{AB} & \nearrow \chi_{AB} & \downarrow F_{BA} \\
\mathbf{B}'(FA, FB) & \xrightarrow{\overline{(-)}} & \mathbf{B}'(B, A)
\end{array}$$

such that the following commute:

$$(32) \quad \begin{array}{ccc}
\overline{Ff} \circ Ff \xrightarrow{\chi^{\text{id}}} F\overline{f} \circ Ff & & Ff \circ \overline{Ff} \xrightarrow{\text{id} \circ \chi} Ff \circ F\overline{f} \\
\downarrow e_{Ff} & & \downarrow \phi \\
I_{FA} \xrightarrow{\phi} FI_A \xleftarrow{Fe_f} F(\overline{f} \circ f) & & I_{FB} \xrightarrow{\phi} FI_B \xleftarrow{Fi_f} F(f \circ \overline{f})
\end{array}$$

with $f \in \mathbf{B}(A, B)$.

We need to know what it means for two bicategories to be equivalent.

DEFINITION A.7. If P is a property of functors, then a weak 2-functor F is called *locally P* if the functor F_1 has the property P .

EXAMPLE A.8. ‘Properties of functors’ include *full*, *faithful*, *essentially surjective*, *equivalence of categories* and combinations thereof.

DEFINITION A.9. A weak 2-functor $F: \mathbf{B} \rightarrow \mathbf{B}'$ is called an *equivalence of bicategories* if it is locally an equivalence and for every $A \in \mathbf{B}'_0$ there is an object $B \in \mathbf{B}_0$ and an equivalence $FB \rightarrow A$. This last condition is put more succinctly by saying F is essentially surjective, in analogy with the case of 1-categories.

It is an old result that monoidal categories ‘are’ bicategories with only a single 0-cell. It follows that monoidal groupoids ‘are’ weak (2,1)-categories with a single 0-cell, with caveats as noted in the following paragraph.

PROPOSITION A.10. *Bicategories (resp. bigroupoids) and weak 2-functors form a category \mathbf{Bicat}_0 (resp. \mathbf{Bigpd}_0).*

There are *transformations* (of varying sorts) between weak 2-functors, and *modifications* between those, and the whole collection of bicategories, weak 2-functors and these maps forms a weak 3-category (or tricategory [GPS95]) \mathbf{Bicat} . There is no bicategory sitting in the heirachy between the category and 3-category of bi-categories due to the fact transformations of weak 2-functors do not compose in an associative manner. The same holds for bigroupoids. This seems at odds with the idea that 2-groups, which ‘are’ one-object bigroupoids, form a 2-category, but the authors of [CG07] showed that the *categories* of 2-groups and single-object bigroupoids are equivalent, but the 3-categories of such are not. The reason for this is homotopy theoretic: pointed connected homotopy types are not identical to unpointed connected homotopy types. The link is via the homotopy hypothesis of Grothendieck [Gro75, Gro83], namely, that weak n -groupoids are models for homotopy n -types.

2. 2-groups

The aim of this short section is to collect some terminology and definitions. The definitions are fairly loaded, assuming knowledge of monoidal categories. Even though 2-groups have been studied for decades now, the recent article [BL04] gathers many results not easily obtainable, and is a general reference for the rest of the section. Most, if not all, of the following appears therein.

DEFINITION A.11. A *2-group* is a monoidal groupoid (G, \otimes, I, a, l, r) where every object $x \in G$ has a specified weak inverse \bar{x} and arrows $i_x: I \rightarrow x \otimes \bar{x}$, $e_x: \bar{x} \otimes x \rightarrow I$ such that the following commute

$$\begin{array}{ccc} I \otimes x & \xrightarrow{i_x \otimes \text{id}} & (x \otimes \bar{x}) \otimes x \xrightarrow{a} x \otimes (\bar{x} \otimes x) \\ l_x \downarrow & & \downarrow \text{id} \otimes e_x \\ x & \xrightarrow{r_x^{-1}} & x \otimes I \end{array}$$

$$\begin{array}{ccc} \bar{x} \otimes I & \xrightarrow{\text{id} \otimes i_x} & \bar{x} \otimes (x \otimes \bar{x}) \xrightarrow{a} (\bar{x} \otimes x) \otimes \bar{x} \\ r_x \downarrow & & \downarrow e_x \otimes \text{id} \\ \bar{x} & \xrightarrow{l_x^{-1}} & I \otimes \bar{x} \end{array}$$

If a, l, r, i, e are all identities, then the 2-group is called *strict*.

It is an elementary fact that the functor

$$\{g\} \times G \rightarrow G \times G \xrightarrow{\otimes} G$$

is an equivalence for all $g \in G_0$, and similarly for right multiplication. Indeed, this is an alternative definition of a 2-group: a monoidal groupoid such that right and left multiplication by every object is an equivalence.

EXAMPLE A.12 ([CG01]). The fundamental groupoid $\Pi_1(\Omega X)$ of a (based) loop space is a 2-group, called the *fundamental 2-group of X* and denoted $\Pi_2(X, *)$. The homotopy associative H-space structure on ΩX makes $\Pi_2(X, *)$ a monoidal groupoid, and the map sending a loop to the loop traversed in the reverse direction gives the weak inverses.

EXAMPLE A.13. If B is a bigroupoid, then the full sub-bigroupoid on a single 0-cell $b \in B_0$ is a 2-group, denoted $\mathcal{E}q(b)$. If B is a 2-groupoid, then this 2-group is strict. The previous example arises from the special case $B = \Pi_2^T(X)$, the fundamental bigroupoid described in [Ste00, HKK01]

This example is generic, in that a 2-group is given by precisely the same data as a bigroupoid (definition A.2) with a single 0-cell. When we want to consider said bigroupoid for a given 2-group \mathcal{G} , it will be denoted $\mathbf{B}\mathcal{G}$, analogously to the case of a group being considered as a one-object groupoid.

EXAMPLE A.14. A strict 2-group is the same thing as a groupoid internal to the category \mathbf{Grp} . Further, these are equivalent to crossed modules [BS76]. Indeed, some treatments of 2-groups work exclusively with crossed modules. We will need the definition in full generality, however.

Given a 2-group G , there are two invariants associated to it: the automorphisms of the unit $\pi_2(G) = G(I, I)$ and the group of orbits $\pi_1(G) = G_0/G_1$. The first is abelian, and the second can be either abelian or nonabelian. In the case that G is a fundamental 2-group, these are just the first and second homotopy groups of the space in question (hence the notation). More is true: 2-groups are models of path connected pointed homotopy 2-types [MW50], so every 2-group is equivalent to the fundamental 2-group of some space.

DEFINITION A.15. A *homomorphism* between 2-groups G_1, G_2 is a monoidal functor $F: G_1 \rightarrow G_2$.

A strict homomorphism is a homomorphism that is strict as a monoidal functor. That is, it respects the multiplication and unit strictly. Any homomorphism $F: G_1 \rightarrow G_2$ between 2-groups induces homomorphisms $\pi_i(G_1) \rightarrow \pi_i(G_2)$, $i = 1, 2$.

EXAMPLE A.16. A pointed map between pointed topological spaces $f: (M_1, m) \rightarrow (M, p)$ induces a strict homomorphism $\Pi_2(M_1, m) \rightarrow \Pi_2(M, p)$

Notice we do not require that a homomorphism respect the weak inverses coherently. This is apparently at odds with the idea that a 2-group is a bigroupoid and a homomorphism is a weak 2-functor (see definition A.6), but such coherence comes for free!

PROPOSITION A.17. ([BL04], Theorem 6.1) *If $F: G_1 \rightarrow G_2$ is a monoidal functor between 2-groups, there is a unique arrow $\zeta_g: \overline{F(g)} \rightarrow F(\overline{g})$ such that*

$$\begin{array}{ccc} F(g) \otimes \overline{F(g)} & \xrightarrow{\text{id} \otimes \zeta_g} & F(g) \otimes F(\overline{g}) \xrightarrow{\phi} F(g \otimes \overline{g}) \\ \uparrow i_{F(g)} & & \uparrow F(i_g) \\ I_{G_2} & \xrightarrow{u} & F(I_{G_1}) \end{array}$$

and

$$\begin{array}{ccc} \overline{F(g)} \otimes F(g) & \xrightarrow{\zeta_g \otimes \text{id}} & F(\overline{g}) \otimes F(g) \xrightarrow{\phi} F(\overline{g} \otimes g) \\ \uparrow e_{F(g)} & & \uparrow F(e_g) \\ I_{G_2} & \xrightarrow{u} & F(I_{G_1}) \end{array}$$

commute.

2-groups and homomorphisms form a category $2\mathbf{Grp}_0$, and just as the fundamental group is a functor from spaces to groups, the fundamental 2-group (of a space) is a functor

$$\Pi_{2,*}: \mathbf{Top} \rightarrow 2\mathbf{Grp}_0.$$

Since 2-groups are groupoids, we have 2-arrows between homomorphisms.

DEFINITION A.18. A *transformation of homomorphisms* (or simply *transformation*) between 2-groups is a monoidal transformation.

PROPOSITION A.19. *There is a 2-category $2\mathbf{Grp}$ with 2-groups as objects, homomorphisms as 1-arrows and transformations of homomorphisms as 2-arrows.*

An equivalence of 2-groups is just an equivalence in the sense of this 2-category. It induces isomorphisms on π_1, π_2 , justifying calling them invariants earlier.

Just as every monoidal category is equivalent to a strict monoidal category, every 2-group is equivalent to a strict 2-group. The construction of such a strict 2-group (actually crossed module, which is the same thing) from what [BL04] calls a *special* 2-group can be found in [EM47], and in [JS86, BL04] every 2-group is shown to be equivalent to a special 2-group. Thus the full sub-2-category of strict 2-groups is equivalent to $2\mathbf{Grp}$. Note however, that not every homomorphism is isomorphic to a strict homomorphism. There is a classification of 2-groups [Sin75, JS86], such that every 2-group is given up to equivalence by a group G , an abelian group A with a G -action $G \rightarrow \text{Aut}(A)$, and an element of $H^3(G, A)$ (this is also the data for a special 2-group). We will not be using this fact – the interested reader can refer to [BL04].

Bibliography

- [ACJ05] P. Aschieri, L. Cantini, and B. Jurčo, *Nonabelian bundle gerbes, their differential geometry and gauge theory*, Comm. Math. Phys. **254** (2005), no. 2, 367–400.
- [Ald07] E. Aldrovandi, *2-Gerbes bound by complexes of gr-stacks, and cohomology*, J. Pure Appl. Algebra **212** (2007), 994–1038.
- [AN09] E. Aldrovandi and B. Noohi, *Butterflies II: Torsors for 2-group stacks*, 2009, arXiv:0909.3350.
- [Bae97] J. Baez, *Higher dimensional algebra II: 2-Hilbert spaces*, Adv. Math. **127** (1997), 125–189, [arXiv:math/9609018].
- [Bak] I. Bakovic, *Grothendieck construction for bicategories*, unpublished.
- [Bak07] ———, *Bigroupoid 2-torsors*, Ph.D. thesis, Ludwig-Maxmillians-Universität München, 2007, available from <http://www.irb.hr/korisnici/ibakovic/>.
- [Bar06] T. Bartels, *Higher gauge theory I: 2-Bundles*, Ph.D. thesis, University of California Riverside, 2006, arXiv:math.CT/0410328.
- [BCM⁺02] P. Bouwknegt, A. Carey, V. Mathai, M. K. Murray, and D. Stevenson, *Twisted K-theory and K-theory of bundle gerbes*, Commun. Math. Phys. **228** (2002), no. 1, 17–49.
- [BD95] J. Baez and J. Dolan, *Higher dimensional algebra and topological quantum field theory*, J. Math. Physics **36** (1995), no. 11, 6073–6105.
- [Bén67] J. Bénabou, *Introduction to bicategories*, Proceedings of the midwest category seminar, Springer Lecture Notes, vol. 47, Springer-Verlag, 1967.
- [BGNX08] K. Behrend, G. Ginot, B. Noohi, and P. Xu, *String topology for stacks*, 2008, [arXiv:math.AT/0712.3857].
- [BH10] J. Baez and A. Hoffnung, *Convenient categories of smooth spaces*, Trans. Amer. Math. Soc. (2010), to appear, [arXiv:0807.1704].
- [BL03] J. Baez and L. Langford, *Higher dimensional algebra IV: 2-tangles*, Adv. Math. **180** (2003), 705–764, [arXiv:math/9811139].
- [BL04] J. Baez and A. Lauda, *Higher dimensional algebra V: 2-groups*, Theory and Appl. Categ. **12** (2004), no. 14, 423–491.
- [Bli00] D.K. Bliss, *A generalized approach to the fundamental group*, American Math. Monthly **107** (2000), no. 8, 711–720.
- [Bli02] ———, *The topological fundamental group and generalized covering spaces*, Topology Appl. **124** (2002), 355–371.
- [BN96] J. Baez and M. Neuchl, *Higher dimensional algebra I: Braided monoidal 2-categories*, Adv. Math. **121** (1996), 183–223.
- [BP79] M. Bunge and R. Paré, *Stacks and equivalence of indexed categories*, Cahiers Topologie Géom. Différentielle **20** (1979), no. 4, 373–399.
- [Bra09] J. Brazas, *The topological fundamental group and hoop earring spaces*, 2009, arXiv:0910.3685.
- [Bre94] L. Breen, *Classifying 2-gerbes and 2-stacks*, Astérisque, no. 225, Société Mathématique de France, 1994.
- [Bro70] R. Brown, *Fibrations of groupoids*, J. Algebra **15** (1970), 103–132.
- [Bro06] ———, *Topology and groupoids*, www.groupoids.org, 2006.

- [Bry93] J-L Brylinski, *Loop spaces, characteristic classes and geometric quantisation*, Progress in Mathematics, vol. 107, Birkhäuser-Verlag, Boston, 1993.
- [BS76] R. Brown and C. B. Spencer, *G-groupoids, crossed modules and the fundamental groupoid of a topological group*, Nederl. Akad. Wetensch. Proc. Ser. A **79** (1976), no. 4, 296–302.
- [BS07] J. Baez and U. Schreiber, *Higher gauge theory*, Categories in algebra, geometry and mathematical physics (Streetfest) (A. Davydov, ed.), Contemp. Math., vol. 431, Amer. Math. Soc., 2007, [arXiv:hep-th/0511710].
- [BS10] J. Baez and M. Shulman, *Lectures on n-categories and cohomology*, Towards higher categories (J. Baez and J.P. May, eds.), The IMA Volumes in Mathematics and its Applications, vol. 152, Springer, 2010, FIX THIS.
- [BW84] M. Barr and C. Wells, *Toposes, triples and theories*, Grundlehren der mathematischen wissenschaften, no. 278, Springer-Verlag, 1984, Version 1.1 available from <http://www.cwru.edu/artsci/math/wells/pub/ttt.html>.
- [BX03] K. Behrend and P. Xu, *S^1 -bundles and gerbes over differentiable stacks*, C. R. Acad. Sci. Paris, Ser. I **336** (2003), no. 2, 163–168.
- [CG01] A. M. Cegarra and A. R. Garzón, *Homotopy classification of categorical torsors*, Appl. Categ. Structures **9** (2001), 465–496.
- [CG07] E. Cheng and N. Gurski, *The periodic table of n-categories for low dimensions. I. Degenerate categories and degenerate bicategories*, Categories in algebra, geometry and mathematical physics, Contemp. Math., vol. 431, Amer. Math. Soc., Providence, RI, 2007, pp. 143–164.
- [CGV06] P. Carrasco, A.R. Garzón, and E.M. Vitale, *On categorical crossed modules*, Theory and Appl. Categ. **16** (2006), no. 22, 585–618.
- [Col06] H. Colman, *On the homotopy 1-type of Lie groupoids*, 2006, [arXiv:math/0612257].
- [Deb77] R. Debremaeker, *Non abelian cohomology*, Bull. Soc. Math. Belg. Ser. A **29** (1977), no. 1, 57–72.
- [Dol63] A. Dold, *Partitions of unity in the theory of fibrations*, Ann. Math. **78** (1963), no. 2, 223–255.
- [Dup08a] M. Dupont, *Abelian categories in dimension 2*, Ph.D. thesis, Université catholique de Louvain, Louvain-la-Neuve, 2008.
- [Dup08b] ———, *Categories without a set of objects, n-orders, constructivism*, 2008, unpublished notes.
- [Ebe09] J. Ebert, *The homotopy type of a topological stack*, 2009, preprint, [arXiv:0901.3295].
- [Ehr59] C. Ehresmann, *Catégories topologiques et catégories différentiables*, Colloque Géom. Diff. Globale (Bruxelles, 1958), Centre Belge Rech. Math., Louvain, 1959, pp. 137–150.
- [Ehr63] ———, *Catégories structurées*, Annales de l’Ecole Normale et Supérieure **80** (1963), 349–426.
- [EKvdL05] T. Everaert, R.W. Kieboom, and T. van der Linden, *Model structures for homotopy of internal categories*, TAC **15** (2005), no. 3, 66–94.
- [EM47] S. Eilenberg and S. MacLane, *Cohomology theory in abstract groups II*, Ann. Math. **48** (1947), no. 2, 326–341.
- [Fab09] P. Fabel, *Multiplication is discontinuous in the Hawaiian earring group (with the quotient topology)*, 2009, arXiv:0909.3086.
- [Gir71] J. Giraud, *Cohomologie non abélienne*, Springer-Verlag, Berlin-New York, 1971.
- [GPS95] R. Gordon, A. J. Power, and Ross Street, *Coherence for tricategories*, Mem. Amer. Math. Soc. **117** (1995), no. 558, vi+81.
- [Gro71] A. Grothendieck, *SGA1 – Revêtements étales et groupe fondamental*, Lecture Notes in Mathematics, vol. 224, Springer-Verlag, 1971, Séminaire de Géométrie Algébrique du Bois Marie 1960–1961, Dirigé par Alexandre Grothendieck. Augmenté de deux exposés de M. Raynaud.
- [Gro75] ———, *Letters to L. Breen*, Dated 17/2/1975, 1975, 17-19/7/1975. Available from <http://www.grothendieckcircle.org/>, 1975.

- [Gro83] ———, *Pursuing stacks*, To appear, *Documents Mathématiques*, eds. G. Maltsiniotis, M. Künzer and B. Toen, Manuscript 1983.
- [GS08] G. Ginot and M. Stienon, *G-gerbes, principal 2-group bundles and characteristic classes*, 2008, arXiv:0801.1238.
- [Hae71] A. Haefliger, *Homotopy and integrability*, Manifolds (Amsterdam, 1970), Springer Lecture Notes, vol. 197, 1971, pp. 13–163.
- [Hae90] ———, *Orbi-espaces*, Sur les groupes hyperbolique d’après Mikhael Gromov, Progress in Mathematics, vol. 83, Birkhäuser, 1990, pp. 203–213.
- [Ham82] R. S. Hamilton, *The inverse function theorem of Nash and Moser*, Bull. AMS (new series) **7** (1982), no. 1, 65–222.
- [Hat02] A. Hatcher, *Algebraic topology*, Cambridge University Press, 2002, available from <http://www.math.cornell.edu/~hatcher/>.
- [Her99] C. Hermida, *Some properties of Fib as a fibred 2-category*, J. Pure Appl. Algebra **134** (1999), 83–109.
- [HKK00] K. A. Hardie, K.H. Kamps, and R.W. Kieboom, *A homotopy 2-groupoid of a hausdorfff space*, Applied Categorical Structures **8** (2000), 209–234.
- [HKK01] K.A. Hardie, K.H. Kamps, and R.W. Kieboom, *A homotopy bigroupoid of a topological space*, Appl. Categ. Structures **9** (2001), 311–327.
- [HKK02] K. A. Hardie, K.H. Kamps, and R.W. Kieboom, *Fibrations of bigroupoids*, J. Pure Appl. Algebra **168** (2002), 35–43.
- [HS87] M. Hilsun and G. Skandalis, *Morphismes-orientés d’epsaces de feuilles et functorialité en théorie de Kasparov (d’après une conjecture d’A. Connes)*, Ann. Sci. École Norm. Sup. **20** (1987), 325–390.
- [JS86] A. Joyal and R. Street, *Braided monoidal categories*, Mathematics Report 860081, Macquarie University, November 1986, available from <http://www.math.mq.edu.au/~street>.
- [JS91] ———, *The geometry of tensor calculus*, Advances in Math. **88** (1991), 55–112.
- [Jur05] B. Jurčo, *Crossed module bundle gerbes; classification, string group and differential geometry*, 2005.
- [KP97] K.H. Kamps and T. Porter, *Abstract homotopy and simple homotopy theory*, World Scientific Publishing Co., 1997.
- [KV94] M. Kapranov and V. Voevodsky, *2-categories and Zamolodchikov tetrahedra equations*, Algebraic groups and their generalisations, Proc. Symp. Pure Math., vol. 56, Amer. Math. Soc., Providence, Rhode Island, 1994, pp. 177–260.
- [Lan01] N.P. Landsman, *Bicategories of operator algebras and Poisson manifolds*, Fields Institute Communications **30** (2001), 271–286.
- [Lei98] T. Leinster, *Basic bicategories*, 1998, [arXiv:math.CT/9810017].
- [Lei01] ———, *A survey of definitions of n-category*, [arXiv:math.CT/0107188], 2001.
- [Lei03] ———, *Higher operads, higher categories*, London Math. Soc. Lecture Note Series, Cambridge University Press, 2003, [arXiv:math.CT/0305049].
- [Lew07] R. P. I. Lewis, *Stacks and formal maps of crossed modules*, Ph.D. thesis, University of Wales, Bangor, 2007.
- [LGSX09] C. Laurent-Gengoux, M. Stienon, and P. Xu, *Non-abelian differential gerbes*, Adv. Math. **220** (2009), no. 5, 1357–1427.
- [Lim03] E.L. Lima, *Fundamental groups and covering spaces*, A K Peters Ltd., 2003, translated from the Portuguese by Jonas Gomes.
- [Mac71] S. MacLane, *Categories for the working mathematician*, Springer-Verlag, 1971.
- [Mac05] K. Mackenzie, *General theory of lie groupoids and lie algebroids*, Lecture Notes Series, no. 213, Cambridge University Press, 2005.
- [Mak96] M. Makkai, *Avoiding the axiom of choice in general category theory*, JPAA **108** (1996), 109–173.
- [May72] J.P. May, *The geometry of iterated loop spaces*, Lecture Notes in Mathematics, vol. 271, Springer-Verlag, 1972.

- [Mil56] J. Milnor, *Construction of universal bundles II*, Ann. Math. **63** (1956), 430–436.
- [MM92] S. MacLane and I. Moerdijk, *Sheaves in geometry and logic*, Springer-Verlag, 1992.
- [MM03] I. Moerdijk and J. Mrčun, *Introduction to foliations and lie groupoids*, Cambridge studies in advanced mathematics, vol. 91, Cambridge University Press, 2003.
- [MM05] ———, *Lie groupoids, sheaves and cohomology*, Poisson geometry, deformation quantisation and group representations, London Math. Soc. Lecture Note Series, no. 323, Cambridge University Press, 2005, pp. 145–272.
- [Moe89] I. Moerdijk, *Descent theory for toposes*, Bull. Soc. Math. Belg. Ser. A **41** (1989), 373–391.
- [Moe03] ———, *Lie groupoids, gerbes, and non-abelian cohomology*, K-Theory **28** (2003), no. 3, 207–258.
- [MRS] M. K. Murray, D.M. Roberts, and D. Stevenson, *Bibundle gerbes*, work in progress.
- [MS93] I. Moerdijk and J. Svensson, *Algebraic classification of equivariant homotopy 2-types, part i.*, J. Pure Appl. Algebra **89** (1993), 187–216.
- [MS03] M. K. Murray and D. Stevenson, *Higgs fields, bundle gerbes and string structures*, Comm. Math. Phys. **243** (2003), no. 3, 541–555.
- [Mur96] M. K. Murray, *Bundle gerbes*, J. London Math. Soc. **54** (1996), no. 2, 403–416.
- [Mur09] ———, *An introduction to bundle gerbes*, The many facets of geometry, a tribute to Nigel Hitchin (O. Garcia-Prada, J.-P. Bourguignon, and S. Salamon, eds.), Oxford University Press, 2009, [arXiv:math.DG/0712.1651].
- [MW50] S. MacLane and J.H.C. Whitehead, *On the 3-type of a complex*, Proc. Nat. Acad. Sci. USA **36** (1950), no. 1, 41–48.
- [nLa] nLab, *Klein 2-geometry I-XI*, <http://ncatlab.org/nlab/show/Klein+2-geometry>.
- [nLa09a] ———, *Covering space*, July 2009, <http://ncatlab.org/nlab/show/covering+space>.
- [nLa09b] ———, *Trimble n-category*, 2009, <http://ncatlab.org/nlab/show/Trimble+n-category>.
- [Noo] B. Noohi, *Foundations of topological stacks II*, unpublished notes.
- [Noo05] ———, *Foundations of topological stacks I*, 2005, [arXiv:math.AG/0503247].
- [Noo08a] ———, *Fundamental groups of topological stacks with slice property*, Algebraic and Geometric Topology **8** (2008), 1333–1370, [arXiv:math.AT/0710.2615].
- [Noo08b] ———, *Homotopy types of topological stacks*, 2008, preprint, [arXiv:0808.3799].
- [Noo09] ———, *Integrating morphisms of Lie 2-algebras*, 2009, preprint, [arXiv:0910.1818].
- [Pra89] J. Pradines, *Morphisms between spaces of leaves viewed as fractions*, Cahiers Topologie Géom. Différentielle Catég. **30** (1989), no. 3, 229–246.
- [Pro96] D. Pronk, *Etendues and stacks as bicategories of fractions*, Compositio Math. **102** (1996), no. 3, 243–303.
- [Pro07] ———, *Higher dimensional categories of fractions*, 2007, talk given at the Workshop on higher categories and their applications, held at the Fields Institute.
- [PW05] P. Polesello and I. Waschkie, *Higher monodromy*, Homology, Homotopy and Applications **7** (2005), no. 1, 109–150.
- [Rob] D.M. Roberts, *Homotopy groups of topological groupoids*, unpublished notes.
- [RS] D.M. Roberts and A. Stacey, *Work in progress*.
- [RS08] D.M. Roberts and U. Schreiber, *The inner automorphism 3-group of a strict 2-group*, J. Homotopy Rel. Struct. **3** (2008), no. 1, 193–245.
- [Sch05] U. Schreiber, *From loop space mechanics to nonabelian strings*, Ph.D. thesis, Universität Duisburg-Essen, 2005.
- [Sch07] ———, *Arrow-theoretic differential theory*, 2007, unpublished notes.
- [Seg68] G. Segal, *Classifying spaces and spectral sequences*, Inst. Hautes Études Sci. Publ. Math. (1968), no. 34, 105–112.
- [Seg70] ———, *Cohomology of topological groups*, Symposia Mathematica, Vol IV (INDAM, Rome, 1968/69), Academic Press, 1970, pp. 377–387.
- [Seg74] ———, *Categories and cohomology theories*, Topology **13** (1974), 293–312.
- [Sin75] H. Sinh, *Gr-categories*, Ph.D. thesis, Université Paris VII, 1975.
- [Spa66] E.H. Spanier, *Algebraic topology*, McGraw-Hill, New York, 1966.

- [Ste00] D. Stevenson, *The geometry of bundle gerbes*, Ph.D. thesis, Adelaide University, Department of Pure Mathematics, 2000.
- [SW09] U. Schreiber and K. Waldorf, *Parallel transport and functors*, J. Homotopy Rel. Struct. **4** (2009), 187–244, [arXiv:math/0705.0452].
- [tD66] T. tom Dieck, *Klassifikation numerierbarer bündel*, Arch. Math. **17** (1966), 395–399.
- [Tri99] T. Trimble, *What are ‘fundamental n -groupoids’?*, seminar at DPMMS, Cambridge, 24 August, 1999.
- [Ulbr90] K.-H. Ulbrich, *On the correspondence between gerbes and bouquets*, Math. Proc. Cambridge Phil. Soc. **108** (1990), 1–5.
- [Ulbr91] ———, *On cocycle bitorsors and gerbes over a Grothendieck topos*, Math. Proc. Cambridge Phil. Soc. **110** (1991), 49–55.
- [Wad55] H. Wada, *Local connectivity of mapping spaces*, Duke Math. J. **22** (1955), 419–425.
- [Whi52] G.W. Whitehead, *Fiber spaces and the Eilenberg homology groups*, Proc. Nat. Acad. Sci. USA **38** (1952), no. 5, 426–430.
- [Wit88] E. Witten, *The index of the Dirac operator in loop space*, Elliptic modular forms in algebraic topology (Princeton, NJ, 1986) (Berlin), Lecture Notes in Mathematics, no. 1326, Springer-Verlag, 1988, pp. 161–181.
- [WS06] J. Wirth and J.D. Stasheff, *Homotopy transition cocycles*, J. Homotopy Rel. Struct. **1** (2006), no. 1, 273–283.