

R T Russell, Honours thesis 1957

**The structure and petrology
of rocks close to the Broken
Hill Lode.**

Supervisors: B R Lewis, E A Rudd

C O N T E N T S

SUMMARY

INTRODUCTION

ACKNOWLEDGEMENTS

PART I

THE STRUCTURE OF THE BROKEN HILL MINING AREA

1. FARLY OPINIONS ON BROKEN HILL STRUCTURES.
 - C. W. Marsh
 - E. C. Andrews
 - Sir Douglas Mawson
 - E. S. Moore
2. THE WORK OF E.C. ANDREWS, 1922
3. THE CENTRAL GEOLOGICAL SURVEY
 - General Rock Succession and Stratigraphy
 - The C.G.S. Structures
 - a. Folding
 - b. Faulting
4. DEVELOPMENT OF STRUCTURAL IDEAS SINCE C.G.S.
5. RECENT WORK AT BROKEN HILL SOUTH LTD.
 - The Rock Succession
 - Explanation of Cross-sections
 - The Structure of the Area
 - In Conclusion

PART II

PETROLOGICAL ASSISTANCE IN SOLVING BROKEN HILL STRUCTURES

1. THE PROBLEM OF THE POTOSI GNEISSES
2. THE HANGING WALL GNEISSES
3. A STUDY OF BROKEN HILL APLITES

PART III

A DISCUSSION OF THE ORIGINS OF ROCKS CLOSE TO THE MAIN LODGE

1. BANDED IRON FORMATION
 2. AMPHIBOLITES CLOSE TO THE MAIN LODGE
 3. THE SILLIMANITE GNEISSES
 4. SERICITE SCHISTS
 5. THE PLAGIOCLASE "QUARTZITES"
 6. THE ORIGIN OF THE POTOSI GNEISSES
 7. THE ORIGIN OF THE HANGING WALL GNEISSES
-

SUMMARY

The thesis consists of a review of Broken Hill "mine area" structure and the Archean stratigraphy on which it is based. A fourfold division was made.

Part I

This contains a review and discussion of the structural geology close to the main lode. The concept of "en echelon" folding as opposed to "parallel" folding (advocated by past geologists) was introduced in the latest structural interpretation.

Part II

The second section is a comparative petrographic study of several local "marker horizons" at Broken Hill.

viz.,

Potosi Gneiss
Hanging Wall Gneiss
Aplite

The recognition of several distinct horizons of each of these rock types was stressed in Part I. Potosi-like gneisses occur at three separate stratigraphic levels, and the Hanging wall gneisses at two. A microscopic examination led to the conclusion that these rock types are petrologically different. The aplites and "quartzites" collected from widely separated sources were studied with a view towards a possible petrological correlation. Such was not possible.

Part III

The petrogenesis of several structurally important rock types was reviewed. Namely,

Banded Iron Formation
Amphibolite
Sillimanite Gneiss
Sericite schist
Plagioclase "quartzite"
Potosi Gneiss
Hanging wall Gneiss

A microscopic study provided information for a reappraisal of petrogenetic ideas. The role of metasomatism in the genesis of sericite schist, Potosi Gneiss, "quartzite" and Hanging Wall Gneiss was stressed, as opposed to a "dry transformist" approach. On the other hand, the amphibolites were regarded as originally igneous bodies that has suffered intense metamorphism with a lesser degree of metasomatism.

Banded Iron Formation and sillimanite gneiss were undoubtedly sedimentary rocks prior to metamorphism.

Part IV

Part IV consists of thin section descriptions which provided data applied in Parts II and III. A division was made into Part II thin section descriptions and, secondly, those specimens and rock suites used in the study of rock origins.

The correlation of the granitic-type gneisses (Part II) was satisfying enough, but conflicting evidence as to their origins still leaves room for much speculation. The answer must lie in shrewd observation of field relationships that may be exposed by future exploration and development. The application of sounder chemical principles to such processes as metasomatism and granitisation is also desired. Controversy concerning the origin of these rocks will not cease until theories of "wet" and "dry" diffusion and suchlike have been clarified by indisputable experimental evidence.

INTRODUCTION

Of necessity, structural interpretations will change radically in any region as new facts concerning the rock succession come to light. This has been the case at Broken Hill, where diamond drilling, continued mining development, geophysical surveying and more detailed surface mapping are constantly compiling new and important structural data.

The first major attempt at solving the complex Pre-Cambrian structure in this area was made by the New South Wales Geological Survey, directed by E. C. Andrews. The Department of Mines published his splendid account of the district in 1922. Petrological research which accompanies this volume was carried out by W. R. Browne and F. L. Stillwell. Browne described the rocks of the district, excluding those close to the lode, whilst Stillwell studied those rocks in the immediate vicinity of the lode.

E. J. Kenny, who has been assistant geologist to Andrews, published a further contribution to Broken Hill structure in 1932. This publication entitled, "The Broken Hill Lode - its Geological Structure", presents an interesting review of past opinions, followed by a diagnosis of the problem by the author.

In 1936, the principal mining companies, North Broken Hill Ltd., Broken Hill South Ltd., and the Zinc Corporation Ltd., organised the Central Geological Survey, consisting of three geologists - J. K. Gustafson, H. C. Burrell and M. D. Garretty. They set about the task of mapping all accessible underground workings and re-mapping the surface in intimate detail. This concentrated and systematic attack provided much valuable data from which a complete overhaul of the geological structure could be made. Their findings, published by the Geological Society of America in 1950, is a concise account of Broken Hill geology, and represents a milestone.

This interpretation has not been altered materially since 1939, and most exploration drilling has been based on it. However, B. R. Lewis (1957) has suggested that in the light of new evidence this interpretation might be widely in error. The Central Geological Survey interpretation has been rejected on the grounds of faulty structural concepts and an insufficient knowledge of the detailed stratigraphy.

It is proposed in this thesis to review these concepts of structure in the mine area, particularly those of Andrews, Kenny, Gustafson and Lewis. This study has not been extended to a regional structural review. It does, however, involve a discussion of the stratigraphy and general rock succession, on which any structural interpretation must necessarily be dependent. Of specific interest

to the geologist here are certain horizons of lensy granite gneiss, granulite and aplite which have been placed in different horizons on the basis of recent structural ideas. These rocks have been studied microscopically in some detail, and conclusions made on the possibility of allotting them to separate stratigraphic positions.

A major problem in any attempted correlation of structure along the line of lode has been the absence of a suitable "marker" horizon or "Key bed". The sedimentary sequence at Broken Hill consists of a monotonously similar group of intercalated argillites and arenites. Intense regional metamorphism and metasomatism have converted these sediments to garnet-biotite-sillimanite schists and gneisses, sericite-biotite-felspar schists and feldspathic quartzites of such a repetitive and discontinuous nature that none can be used as a "marker" horizon. Granitic gneisses, amphibolites, aplites and granulites also occur in the sequence, interbedded with the metamorphosed sediments. These latter rocks are potential marker horizons, and as such are deserving of special study. A knowledge of the origin of such rocks would be of some assistance to the structural geologist even though it may not have a direct effect on structural interpretation. A petrological study of many Broken Hill rock types was undertaken in an attempt to throw further light on this question of origin. Petrogenesis is always controversial, and for various reasons the Broken Hill rocks have been subject to more than their share of controversy and dogmatic assertion. Combined petrological and accurate chemical studies have rarely proven conclusively the origin of these rock types, and inconclusive field evidence has been of little help. With this in mind, the problem was tackled with the idea of reviewing all the possible modes of origin as propounded by others, bringing up to date the ideas stemming from more recent field observations, and, if possible, of adding any new microscopic evidence to the list of pros and cons.

The latter portion of the thesis consists of thin section descriptions. These are purely factual, and no comments on genetic implications have been included in this section. A section showing the location of rock specimens completes the thesis.

THE STRUCTURE OF THE BROKEN HILL MINING AREA

It is intended to trace changing ideas of Broken Hill structure in chronological order in this survey of the thesis. This will commence in the early days of the present ideas to which petrological research has been based. Early structural opinions have not been followed through in detail, and significance has been placed in the work of these geologists and their work in the laboratories of N. S. Andrews (1932), J. H. Martin (1935) and M. V. Smith (1957) have been reviewed in some detail.

ACKNOWLEDGEMENTS

I would like to express my deep

appreciation to Mr. B. R. Lewis and members of the Geological Staff at Broken Hill South Ltd., for the assistance given in the collecting of rock specimens and suites at Broken Hill, and in the compilation of plans and cross-sections. Mr. Lewis has made a point of providing all up to date information that might have some bearing on the problem at hand. Mr. J. D. Henderson and Mr. D. Carruthers readily gave permission for the collection of specimens at the North Mine and Zinc Corporation Ltd., respectively. Facilities for the work have been provided by the Department of Economic Geology of the University of Adelaide, and much help has been afforded by Professor E. A. Rudd, Professor of Economic Geology.

rock belts. The lode was regarded as a replacement mass along a fissure, and as replacement along weak layers in schisty corrugations. The shoots were likened to saddle reefs. The stratigraphic sequence had not been established, and structure was largely based on lode shapes from mine and surface exposures.

Sir Douglas Mawson

Sir Douglas Mawson in 1912 noted the saddle-shaped cross-sections of the lode, but observations on rock structures in the vicinity of the lode led him to conclude that the structure of the ore body followed that of the folded adjacent schists and gneisses. Mawson made a comprehensive study of district rock types. He suggested that the bulk of these were sedimentary and of Pre-Cambrian age, because of their relationship to overlying Torrowangee tillites of Proterozoic age. These older rocks, which include the sequence close to the lode, were Archaean in age, and were known as the Willyama Series.

Mawson recognised amphibolites, gneisses, granites and schists, and mentioned also the quartz-feld-spar gneisses, cordierite gneiss, garnet-sillimanite-gneiss and others.

E. S. Moore

E. S. Moore in 1916 wrote a further contribution to Broken Hill geology. He was of the opinion that the apparent conformable disposition of ore and enclosing rock suggested an origin of the ore by selective replacement of a favourable folded horizon. More data were available at this stage on the rock types, and some attempt to divide the granitic rocks had been made. Moore discussed amphibolites, granitic gneisses, pegmatites, diabase and basalt dykes, quartzites and sillimanite gneisses. Larger structures were tentative because rock correlation had not advanced to any great extent.

2. THE WORK OF E. C. ANDREWS, 1922

Andrews, in 1922, published a complete summation up to that time of all geological knowledge concerning Broken Hill. Nearly every facet of the geology of this district was discussed in some way. Petrological studies of many Broken Hill rocks were made by W. R. Browne and F. L. Stillwell, and no stone was left unturned in an endeavour to record and make use of all available data. The final review, published by the Department of Mines under the title. "The Geology of the Broken Hill District", was a magnificent work, and has been a source of constant reference for future geologists working in this district.

Although the rock succession was not solved by Andrews, the rock types themselves were carefully named and described in some detail. In several cases a tentative correlation was attempted, but the complexity of structure away from the lode, and local variations in lithology proved of great difficulty to Andrews. He suggested that a more detailed mapping in the future would enable the complex structures to be solved.

Andrews was impressed by the complexity of folding. He speculated about severe overturning of folds, and the ornamentation of larger folds structures with secondary and tertiary folds on the limbs. Rock masses had been stretched and compressed so that in places severe rock flowage had occurred. Plastic flow was a feature of the folding. This flowage was accompanied by marked thickening of the tops of arches and by the stretching-out of fold limbs.

The folds were, on a minor scale, close and isoclinal, often asymmetrical. Larger structures were puckered and corrugated. The weaker beds, notably the sillimanite gneisses and thinly bedded quartzites, were markedly drag folded against massive beds such as granite gneiss, amphibolite, aplite and pegmatite. These abovementioned larger structures were a group of complex, irregular basins. They were connected by ridges and zones of rock flowage and dislocation. These basins and adjacent arches were not mapped in any detail by Andrews and associates. Andrews recognised three major structures in the vicinity of the main lode:--

Hanging wall Basin

Broken Hill Basin

Broken Hill Arch

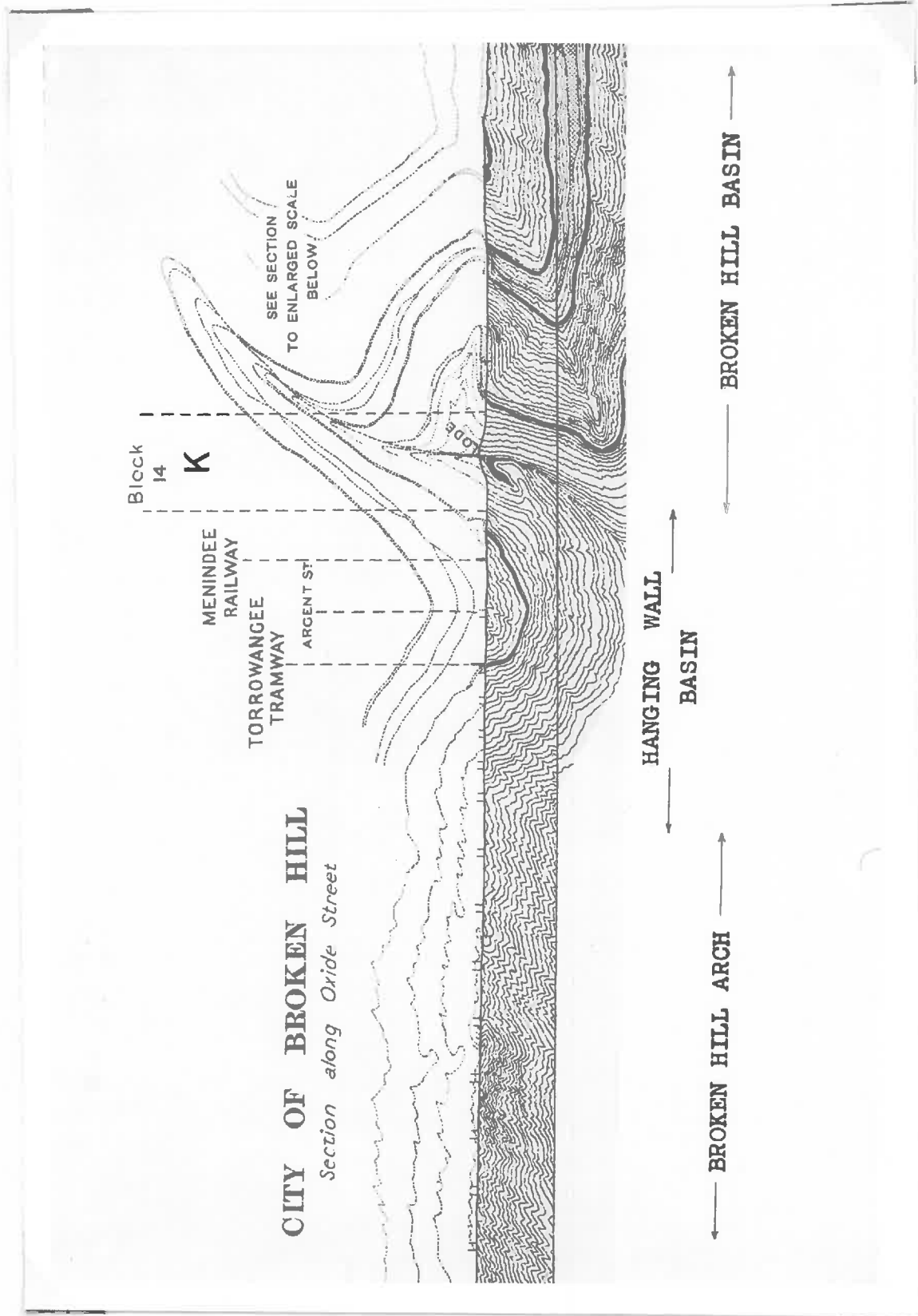

Figure 1 - Cross-section (Andrews), showing relationships between Broken Hill Basin, Hanging Wall Basin and Broken Hill Arch. The "main lode" lies within a "zone of attenuation".

The Broken Hill Basin was supposedly 20 miles long and at a maximum, 4 miles in width. It was folded isoclinally and the general inclination was to the north-west. This basin was separated from the Hanging wall basin by a zone of crush and flowage and the main Broken Hill lode. The Hanging wall Basin was to the west, and the Broken Hill Basin to the east of this zone. The Hanging wall Basin was in the nature of a large pucker on the side of the Broken Hill Basin. The disposition of rocks within the former structure shows that the pitch is very irregular and rolling. It apparently marked the change in form from the Broken Hill Basin to the Broken Hill Arch, lying further to the north-west. This Arch lies at the junction of the Hanging wall Basin to the North-West. The main Broken Hill lode was placed on the eastern margin of this Arch.

Thus it can be seen that the main broader structures had been proposed, but that detailed structural interpretation of the area had been left for the future. Similarly, the rock types had been described and finely classified, but no sequence had been arrived at confidently. Without a stratigraphic succession the finer structures could not be solved. In passing, it is not proposed to discuss the rock types at this stage. These will be described quite fully in a later section.

3. THE CENTRAL GEOLOGICAL SURVEY

Gustafson, Burrell and Garretty made a complete reappraisal of Broken Hill Mine-area structure in the years 1936 to 1939, and their conclusions were submitted to the Broken Hill mining companies in a private report in 1939. In 1950 the Geological Society of America published a modified version of this extensive report which has been of great value to students of Broken Hill geology.

The chief rock types had been described by Andrews and his associates, and the C.G.S. attempted to subdivide the rock assemblage into stratigraphic units, determine the correct sequence of these units, and finally, to solve the structures they portrayed. The C.G.S. interpretation differed from the older one in that:-

- (1) Rock formations were correlated on both sides of the main lode. Thus the Footwall Gneiss was correlated with Potosi Gneiss, Alma augen gneiss with Hanging wall Gneiss, and amphibolites of the so-called "Hanging wall" basin with amphibolites to the east.

- (2) Subdivision of great masses of sillimanite gneiss was attempted.
- (3) The detailed structure differed considerably from the older, although larger structures still harmonised.

General Rock Succession and Stratigraphy

Gustafson found that the greatest obstacles to the solving of the rock succession, and hence the structure, was the absence of persistent "key beds" and the inability to recognise top and bottom of beds. The lency nature of distinctive rock types such as Hanging Wall Gneiss, Potosi-Footwall Gneiss and amphibolite made stratigraphic correlation very difficult. The metamorphosed sedimentary rocks of shaley and sandy origin, now sillimanite gneisses, sericite schists and feldspathic quartzites were subdivided by the C.G.S. but it was found quite impossible to trace a specific horizon for any distance because of the monotonous alteration of sillimanite gneiss and quartzite and the similarity between individual beds of sillimanite gneiss or quartzite following each other in the sequence. Visual differences such as the size of garnets etc. were used to trace beds for short distances, but proved futile at longer intervals. Formations were distinguished by the proportions of rock types common to all, and by the stratigraphic position in known structures.

The C.G.S. such succession consisted of five main groups. These are, from bottom to top:-

- a. the Underwall group
- b. Main lead lode group
- c. Main zinc lode group
- d. Lesser zinc lode group
- e. The overwall group

They were subdivided into formations, and rough guesses as to thicknesses made. Thus, the formations are:-

a. Underwall group

1. Coarse-grained sillimanite gneiss with subordinate beds of fine-grained granular gneiss, both generally with abundant coarse garnets; subordinate thin beds of quartzite.

2. Underwall amphibolites, consisting of several local amphibolite sills.
3. Similar to 1.

b. The Main lead lode group

4. No. 3 lens ore formation, garnet sandstone.
5. Coarse-grained sillimanite gneiss.
6. No. 2 lens ore formation, with lode or garnet quartzite

c. The Main zinc lode group

7. Alternating layers of thinly bedded gneiss and quartzite, containing at least one zinc lode of importance (the overwall zinc lode).
8. Rhodonitic zinc lode formation.
9. Alternating layers of thinly bedded quartzite and gneiss.
10. Siliceous zinc lode formation.

d. Lesser zinc lode group

11. Sillimanite gneiss with coarse garnet bands and local zinc and quartz-gahnite lodes.
12. Consols amphibolites represented by several local amphibolite sills.
13. Sillimanite gneiss with interbedded quartzite and local garnet-magnetite bed near the top. At the Zinc Corporation, and South Mine, sphalerite and gahnite lodes appear.

e. Overwall group

14. Potosi-Footwall Gneiss.
15. Bonanza amphibolite, consisting of local thin amphibolite sills.
16. Sillimanite gneiss with thin beds of quartzite, and a diagnostic bed at the bottom, locally.
17. Town amphibolites - sills of amphibolite.
18. Sillimanite gneiss with considerable coarse-grained garnet, and subordinate quartzite beds.
19. Hanging Wall Granite.

Gustafson recorded numerous post-folding pegmatite dykes, which occupy fractures in the older rocks, as do the later uralite dolerite dykes.

The distribution and correlation of rock types will be made clearer from the comparative cross-section involved later in the discussion of C.G.S. structures. Of course many of these formations are of local significance only, and may not appear on cross-section, depending on the actual position of the

cross-section. Since this treatment has been aimed at comparison with other structural ideas, it will suffice to show only highly distinctive rock types on comparative cross-sections. Thus the subdivision of the Broken Hill lode into 2 lens, 3 lens, etc. is of no real value in this generalised picture, and this applies also to the consideration of sillimanite gneiss and quartzites, and other indistinctive rock horizons.

The C.G.S. Structures

a. Folding

Gustafson et al considered that rocks of the Broken Hill region had been folded isoclinally, and that compression had resulted in a development of individual folds such that the pitch lines were parallel straight lines. Thus in different parts of the area, cross-sections reveal no major changes in the larger synclines and anticlines, for the axes of folds have been continued right through the area.

From east to west the major folds of the district are:-

1. The Broken Hill Basin
2. The Alma anticline
3. The Footwall Basin
4. Eastern anticline
5. Eastern syncline
6. Western anticline
7. Hangingwall Basin
8. The Broken Hill Arch

The cross-section (cross-section 1) through the Delprat shaft shows the relationships of these structural units, and, incidentally, the stratigraphic position of the more important rock types. The main ore-bearing structures are minor folds which embroider the Eastern anticline (west limb), the Eastern syncline and the Western anticline. Folding, with the exception of the Broken Hill arch, is tight, isoclinal and highly complex.

The Broken Hill Basin

This is a major synclinal structure, 20 miles long and 4 miles wide. The C.G.S. only mapped a small portion on the western rim.

The Broken Hill Arch

C.G.S. did not map this structure which was postulated by Andrews in 1922. It embraces the city of Broken Hill and extends for several miles westward.

Hanging Wall Basin

This is a narrow basin with a maximum width of 4,000' situated east of the Broken Hill Arch, and with axial plane striking approximately north-south. Outcrops of Hanging wall Granite reveal an undulatory pitch. This syncline is cut by the Globe Vauxhall crush zone, which runs roughly parallel to its axial plane and along its western rim just inside the Potosi Gneiss formation. Movement on the fault is regarded by Gustafson as being west-block-north. Only a portion of the eastern rim of the Hanging wall Basin was mapped by the C.G.S.

Footwall Basin

This structure was not mentioned by Andrews. It is comparable in size with the Hanging wall Basin, and the pitch line parallels that of the latter structure. It is clearly marked by outcrops of Potosi Gneiss east of the lode.

The Alma anticline

C.G.S. mapping suggest an extremely tight sheared-out anticline between the Footwall Basin and the Broken Hill Basin. The structure is about 800' wide.

Western anticline, Eastern syncline, Eastern anticline

This is an extremely complex, dominantly anticlinal region about 1200' wide. The three major structures above consist of highly complicated minor folds and drags. From south to north there is a gradual change in the relative positions and shapes of these structures with marked undulation of pitch-lines.

b. Faulting

Gustafson believed that the larger faults belonged to a second main period of deformation, chronologically intermediate between folding and ore deposition. The C.G.S. suggest that gneisses and quartzites were formed during plastic flow and recrystallisation associated with folding, whilst sericite schists were produced by post-folding fault movements, as a result of shearing. Thus many occurrences of sericite schist have been mapped as shears or crush zones.

There are two main fault groups, and a third subordinate one in the vicinity of the lode.

1. Strike N 50°E to N 70°E, dip 80° SE.

e.g. Globe Vauxhall crush zone and Morgan's fault. The main shear, a belt of attenuation which occurs in the central part of the field between Footwall and Hanging wall Basin has also been classified with this group. Movement

Movement has been north-west side north-east. The vertical component is unknown but in the case of the Globe Vauxhall horizontal movement was given as nearly 3 miles.

2. Strike No. 15° W to NS; dip steep to the East

e.g. De Bavay fault, British Fault.

These faults cut transversely across the rock formations, warping or offsetting them. They are marked by belts of sericite schist containing numerous pegmatite lenses.

These faults are shown on the accompanying plan.

Gustafson and associates made a special study of the region from the De Bavay fault to Round Hill. They found that major structural features such as the Footwall Basin, Alma anticline and the eastern limb of the Hanging Wall Basin could be easily recognised north of the De Bavay fault. The precise positioning of the North Mine one-bearing folds was not accomplished because of the complexity of structure and absence of data. Three alternative interpretations were made of this area, and all had their share of troubles. The Imperial Ridge syncline, and Round Hill syncline and anticline were recognised by C.G.S., and these structures were regarded as folds on the western flank of the Eastern anticline which die out going southwards.

The region from Zinc Mine to White Leads was also given special treatment. Mapping was carried out between the Hangingwall Basin and the Broken Hill Basin for $3\frac{1}{2}$ miles south of the Zinc Corporation boundary. Correlation of geophysical data by Haddon King and Gustafson in 1947 has enabled a modified interpretation to be arrived at.

The major structures recognised from east to west are:-

Hanging Wall Basin
Rising Sun anticline (equivalent to the
Western anticline)
The Footwall Basin
Alma anticline
Broken Hill Basin

The Western anticline is the dominant anticline between the Hanging wall basin and the Broken Hill Basin in the vicinity of Rising Sun whereas around the Zinc Corporation main shaft (Freeman shaft), the Alma anticline reaches higher than the Western anticline. However, near the White Leads prospect the Alma anticline begins to play a dominant role. Gustafson suggested that pitch trends south of Freeman Shaft were flatly south to beyond White Leads.

The C.G.S. have conveniently summarised the major folds of the northern, central and southern portions of the

district in the table below.

West	Rising Sun (South)	B.H.P. Mine (Central)	Round Hill (North)
	Hanging Wall Basin	Hanging Wall Basin	Hanging Wall Basin
	Rising Sun anticline	Western anticline	
		Eastern syncline	Imperial anticline
		small minor folds	
	Small minor folds		Imperial syncline
		small minor folds	Round Hill anticline
		Eastern anticline	Round Hill syncline
	Footwall Basin	Footwall Basin	Eastern anticline
	Alma anticline	Alma anticline	Footwall Basin
East	Broken Hill Basin	Broken Hill Basin	Alma anticline
			Broken Hill Basin

On the whole the structures were considered as being flat-pitching to the south, the north pitch of the North Mine ore bodies being a local feature.

4. DEVELOPMENT OF STRUCTURAL IDEAS SINCE C.G.S.

The Broken Hill deposit has not been studied in the same detail or with the same overall purpose since the C.G.S., in 1939. Their work was of such a thorough and satisfying nature that discoveries since 1939 were made to fit the general C.G.S. picture no matter how faulty the implication became. Since 1946 there has been a great deal of geological work underground at the Zinc Corporation and New Broken Hill Consolidated mines, and as a result, the structures in this area have been modified to some degree. However, the major structural features of the C.G.S. were retained. The same is true of structures at the North Mine. Much new geological data have been collected on this mine, but the C.G.S. structure still remains as the basis of exploration. Haddon F. King and E. O'Driscoll published a review of the structure of the mine area in the "Geology of Australian Ore Deposits" (1953), and it is clear from this that modifications of the C.G.S. structure were rather minor. The same general stratigraphy was accepted by King and O'Driscoll.

B. P. Thomson in a thesis entitled "Tectonics and Archaean Sedimentation of the Barrier Ranges, N.S.W." has suggested that the structures must be profoundly modified on the basis of more recent diamond drilling. A Section through the

Broken Hill anticline showed unusual "wrongway" drag folds, outlined by O'Driscoll from evidence in the south of the field. The interpretation was accepted by Thomson from further exploration drilling evidence. The axial plane of the Broken Hill anticline was severely buckled and possibly locally recumbent. Longitudinal buckling of folds in a rather complex fashion was suggested from plans. Thomson believed that sectional fold shapes changed rapidly in character with depth. Fold pitches at the surface and at depth often differed violently. Much difficulty had been experienced in recent times as more structural information was unearthed. Unfortunately the tendency has been to continue modifying the C.G.S. structures, in stead of throwing all the old plans aside, and completely reviewing the whole scene again. Such a review is well nigh impossible for geologists who have been "born and bred" on the field and indoctrinated with the convincing C.G.S. interpretations. As has often been the case, new ideas must be left to completely new hands to conceive and implement.

5. RECENT WORK AT BROKEN HILL SOUTH LTD.

B. R. Lewis set about a re-examination of structural data in 1956. This was to be the first complete review since 1939, when the C.G.S. ended their survey. Since that time structural concepts had advanced noticeably, and the compilation of new data had been immeasurable. In particular, thousands of feet of diamond drill core has provided the geologist with new clues on the rock succession.

Core logging was of immediate concern, and it was obvious that existing methods on the field were only supplying information on the more distinctive rock formations. These are not continuous horizons, and of little use in correlating structures any distance apart. The metamorphosed sedimentary series, largely sillimanite gneisses and quartzites, which the C.G.S. had attempted to subdivide was attacked in a slightly different manner. Lewis suggested that by careful recording of the degree of banding (initially bedding) in the rocks, it might be possible to divide them into recognisable stratigraphic units. A legend was adopted that included a recognition of the following rock types:-

- Hanging wall Gneiss
- Augen Gneiss
- Pososi Gneiss
- Amphibolite
- Dolerite (uralite dolerite)
- Banded Iron Formation

Pegmatite

Lode quartzite (garnet quartzite, sandstone)

Lode horizon (mineralisation apparent)

"Quartzites"

Banded, initially shaley rocks

The banded rocks were classified as well-banded (WBD) or fair-banded (FBD). WBD rocks consist almost entirely of finely bedded material, whilst rocks with greater than 50% of finely bedded material are fair-banded. These banded rocks may be either:-

- (1) biotite-sillimanite gneisses
- (2) sericite schists

The former may contain garnet to a greater or lesser extent, and the sericite schists may be with or without dominant biotite and garnet. These rock types may occur within the same horizon, and chemical analysis has shown that the chemical compositions are almost identical. In the field, sericite is most abundant in the zones of maximum rock flowage.

All non-descript rocks with less than 50% banded material were called "quartzites". However, all main features of the rock were recorded, such as the percentage of banded material, dominant minerals, and the development of pegmatitic veining and epidosite.

Re-logging of many thousands of feet of drilling core at North Mine, Zinc Corporation and South Mine, and detailed mapping, both on the surface and underground, enabled a new stratigraphic sequence to be established.

The Rock Succession

Several horizons of granite gneiss have been recognised. These include horizons of Hanging wall Gneiss and Potosi Gneiss, and horizons of pseudo-Potosi Gneiss and pseudo-Hanging wall Gneiss. This has changed the structural picture close to the lode very considerably. Rock types there were thought to be the same by C.G.S. are now placed in separate horizons. Also, another major feature is the recognition of "lode horizon", which may, or may not show signs of mineralisation. C.G.S. considered that this could not be traced if barren. Sericite schists, sillimanite gneiss and quartzites have been included in the sequence but have rarely proven to be "marker" beds over any great area. Banded Iron Formation and amphibolite horizons have been used over wide areas to trace the folded structures.

A generalised stratigraphic succession but it must be realised that many of the horizons are lensy, and may not occur on consecutive cross-sections. From top to bottom;

Quartzites etc.
Amphibolite
Hanging wall Gneiss "B"
Quartzite etc.
Amphibolite
Quartzite etc.
Potosi Gneiss "C"
Quartzite etc.
Lode Horizon
Quartzite
Potosi Gneiss "B"
Quartzites
Amphibolite
Quartzites etc.
Banded Iron Formation
Potosi Gneiss "A"
Banded Iron Formation
Quartzites
Hanging wall Gneiss "A"

The lensy nature of, amphibolites and Potosi-like Gneisses is noticeable. Potosi Gneiss as mapped by the C.G.S. overlies the lode channels, and is particularly lensy and interbedded with sillimanite gneiss. A granular garnet-feldspar-biotite rock, closely resembling Potosi Gneiss also occurs stratigraphically below the lode horizon, and has been called Potosi Gneiss "B", with the overlying horizon of garnet-feldspar-biotite granulite occurs below "B" and is characterised by marginal well-defined horizons of Banded Iron Formations, or B.I.F. These rock types are discussed more fully at a later stage.

Hanging wall Gneiss was placed above the lode by the C.G.S., and as can be seen from their surface plan, exposures were correlated to the east and west of the line of lode. Lewis has made a distinction between these rocks, and on the basis of detailed structural knowledge close to the lode, and hand specimen differences, has proposed that two separate Hanging wall Gneiss-like horizons exist. These have been called Hanging wall Gneiss "A" and "B" for convenience. On Lewis' cross-sections, Hanging wall Gneiss "A" lies beneath the lode horizons, and "B" above it.

Two series of cross-sections based on Lewis' ideas accompany this thesis. The 400 scale sections have been used to illustrate the rock succession and generalised structure. Cross-sections on the scale 1" = 2000' show only local "marker" horizons, but more detailed labelling of structures has been made on these. They accompany the plan of the same scale. It is proposed to discuss the larger sections now, in relationship to the rock succession, and reserve the 2000 scale sections until structures are explained more carefully at a later stage.

Cross-sections were drawn in the positions marked AA, BB and CC, where the structure was well known. They show the relationships of the lensy nature of Potosi-like gneisses and amphibolites. The interpretive cross-section AA, through Imperial Ridge, north of the North Mine, was the result of core logging with Lewis and J. Roberts during the December vacation, and the field mapping of Lewis and P. Forwood. A myriad of diamond drill holes enabled a fairly water-tight interpretation of the area to be arrived at. Similar sections through the Delprat Shaft and the Freeman Shaft were drawn and printed under the guidance of Lewis.

Explanation of Cross-Sections

1. Cross-section "AA"

Imperial Ridge section. It is defined by diamond drill holes approximately 4500' north of the De Bavay fault. The rock succession as observed here is:

top	quartzite, sillimanite gneiss amphibolite quartzites etc. Hanging wall gneiss, amphibolite quartzite Lode horizon quartzites Potosi Gneiss "B" Quartzites etc. B.I.F. Potosi Gneiss "A" B.I.F. Quartzites, sillimanite gneiss.
bottom ...	Hanging wall Gneiss "A"

The upper Hanging wall gneiss is very lensy and it is thought that massive amphibolite occupies the same stratigraphic position to the east. Potosi Gneiss "C" does not appear above the lode as in other cross-sections, but its place is taken by feldspathic quartzite and intercalated sillimanite gneisses.

Other horizons are relatively well-defined. The major structure is synclinal, with a complex pattern of limb folding.

2. Cross Section "BB"

This is a section through the Delprat area of the South Mine, including Delprat Shaft. The main stratigraphic features are similar to those in "AA", but several points are of interest:-

- (1) The complete absence of Hanging wall Gneiss "B".
- (2) Appearance of Potosi "C" above the lode horizon. It is particularly lency, and interbedded with garnet, sillimanite gneiss and quartzite bands. This gives way to amphibolite and sericite at depth.
- (3) The lency nature of Potosi Gneiss "B", very apparent from drilling at Delprat.
- (4) A large mass of steeply dipping sericite schist which is regarded as a major crush zone (the Globe Vauxhall crush zone) by the C.G.S., but as a zone of intense flowage by Lewis.

The rock succession observed here is:-

top	Quartzite
	Sericite schist, sillimanite gneiss or amphibolite
	Potosi Gneiss "C"
	Lode horizon
	Quartzite
	Potosi "B" and sillimanite gneiss
	Quartzite
	B.I.F.
	Potosi Gneiss "A"
	B.I.F.
	Quartzite
bottom ...	Hanging wall Gneiss "A"

3. Cross-section "CC"

A southern transverse section through the Zinc Corporation main shaft (Freeman) area. A very good succession was seen here. Thus:-

top	Hanging wall Gneiss "B"
	Quartzite
	Amphibolite
	Quartzite
	Potosi "C" and sillimanite gneiss
	Quartzite
	Lode horizon
	Quartzite

Potosi "B"
Quartzite
Amphibolite
Quartzite
B.I.F.
Potosi Gneiss "A"
B.I.F.
Hanging wall Gneiss "A"

Of some interest is the great thickness of Potosi "B" at the surface (approximately 1000'), and the characteristic lensy nature of "C", above the lode. In both cross-sections "BB" and "CC", the main ore mined at present is shown as a distinct west limb drag replacement.

The Structure of the Area

The main difference between Lewis's interpretation and that of past geologists is in the nature of the folding. It has been mentioned before that the folds of the C.G.S. were isoclinal and that fold axes were regarded as essentially parallel so that the tops and the bottom of folds were parallel straight lines. This type of folding, due to lateral compression, is shown in the sketch below (fig. 2).

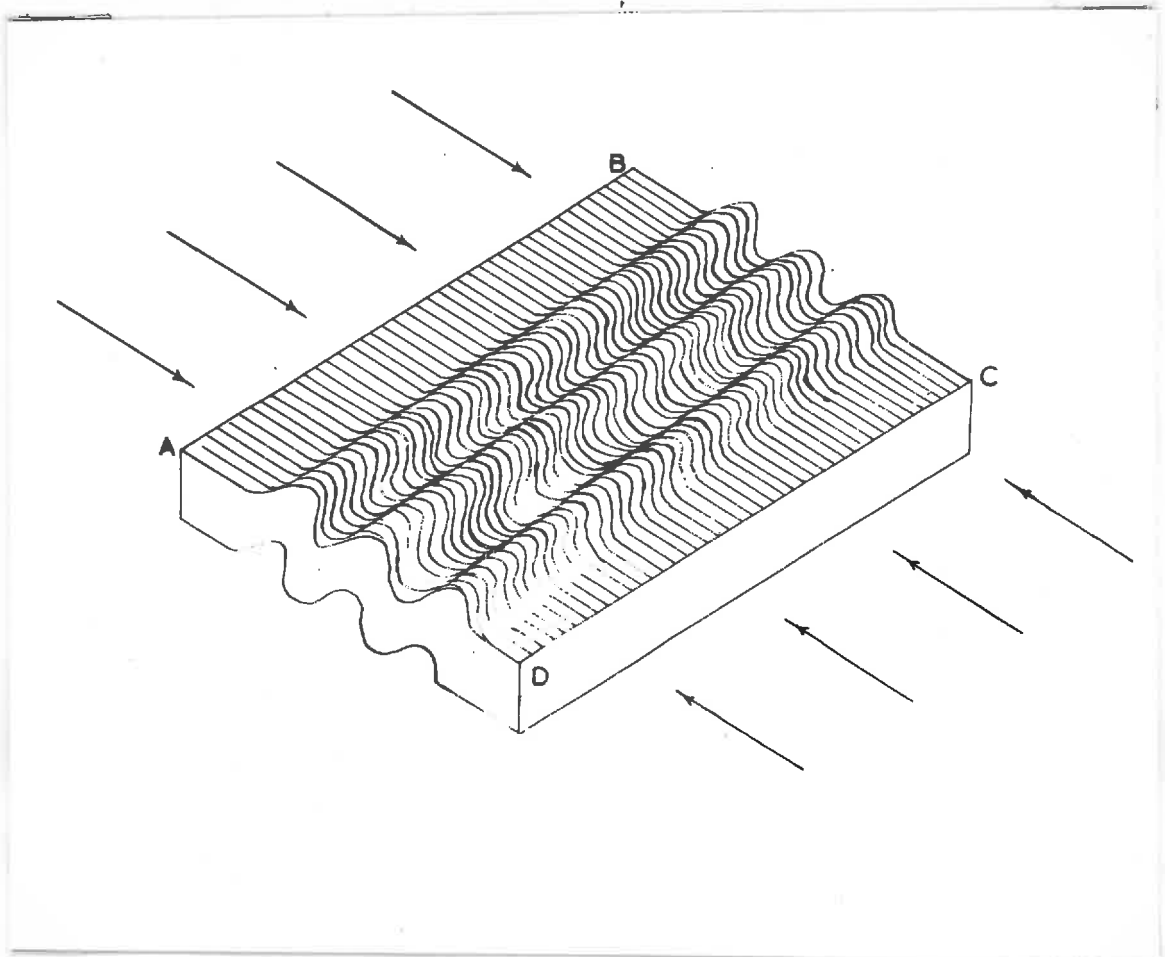

Figure 2. Development of folds characterised by parallel axes from a simple compression acting normal to sides AB and CD.

However, a shearing couple applied to the same block will produce an "en-echelon" fold pattern (figure 3).

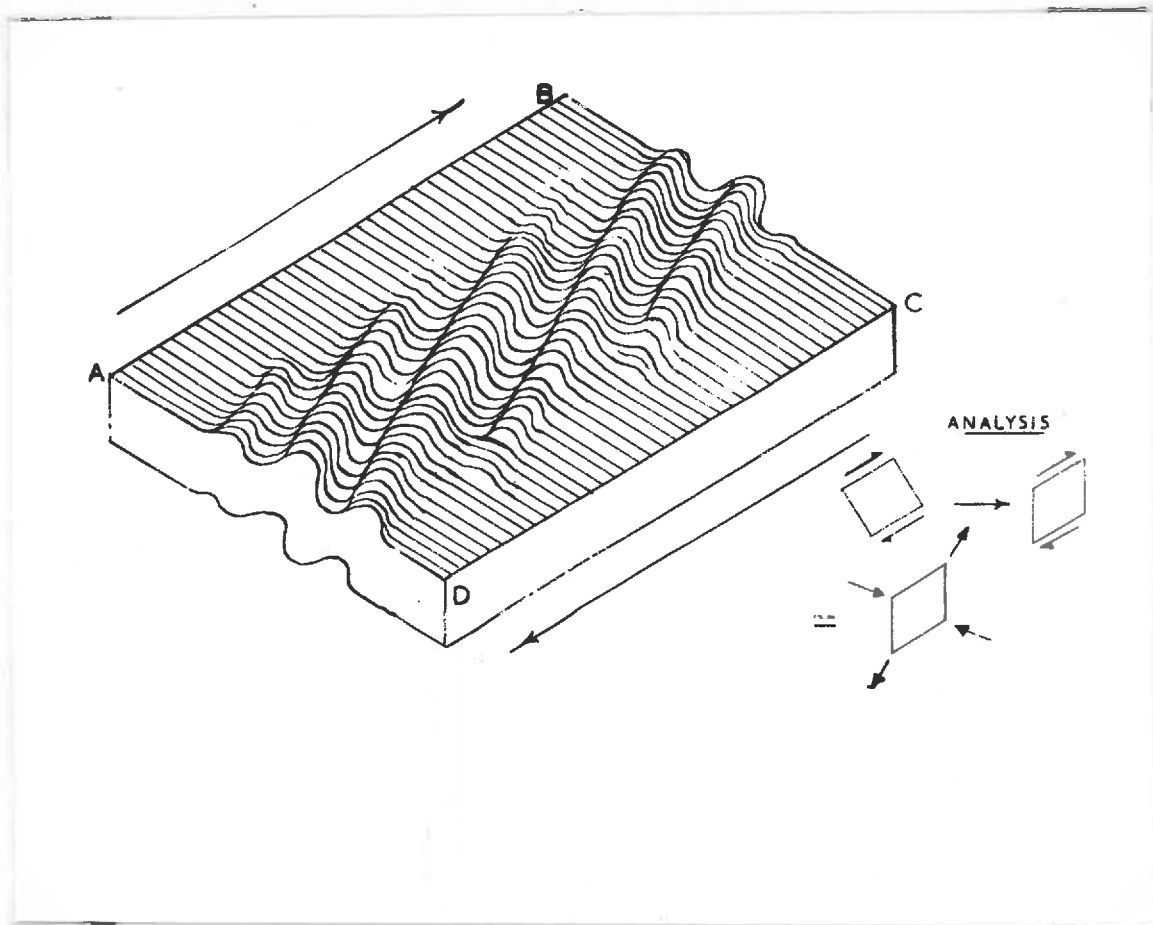

Figure 3. The development of en echelon fold types as the result of a shearing couple AB-CD.

The material in the blocks shown would necessarily be incompetent and yield plastically when subjected to these stresses. Individual "en echelon" folds develop and die out within the stressed area. Their pitch lines are curved, and the peak of the curve occurs at the point of maximum development of the folds. These pitch lines become more strongly curved as the severity of folding increases. A feature of this type of folding, apparent from cross-sections, is the marked change of cross-sectional shapes even

over small intervals. This change is of course, dependant on the severity of folding locally.

Both right-hand and left-hand en echelon fold patterns exist. Viewing the block diagram from either end it can be seen that this represents a right-hand en echelon, consisting of individual folds developing on the right-hand side of dying members. The Broken Hill en echelon pattern is right-handed. A reversal of shear directions would produce a left-hand "en echelon".

Lewis has stressed the dominance of plastic folding and flow, but definite fracturing occurs in some localities. Two complimentary fractures would develop in these blocks under the same couple if the material behaved competently. These fractures find direct evidence in the field.

The Broken Hill ore body was interpreted as a west-facing fold, or a series of these at the North Mine (see figure 5).

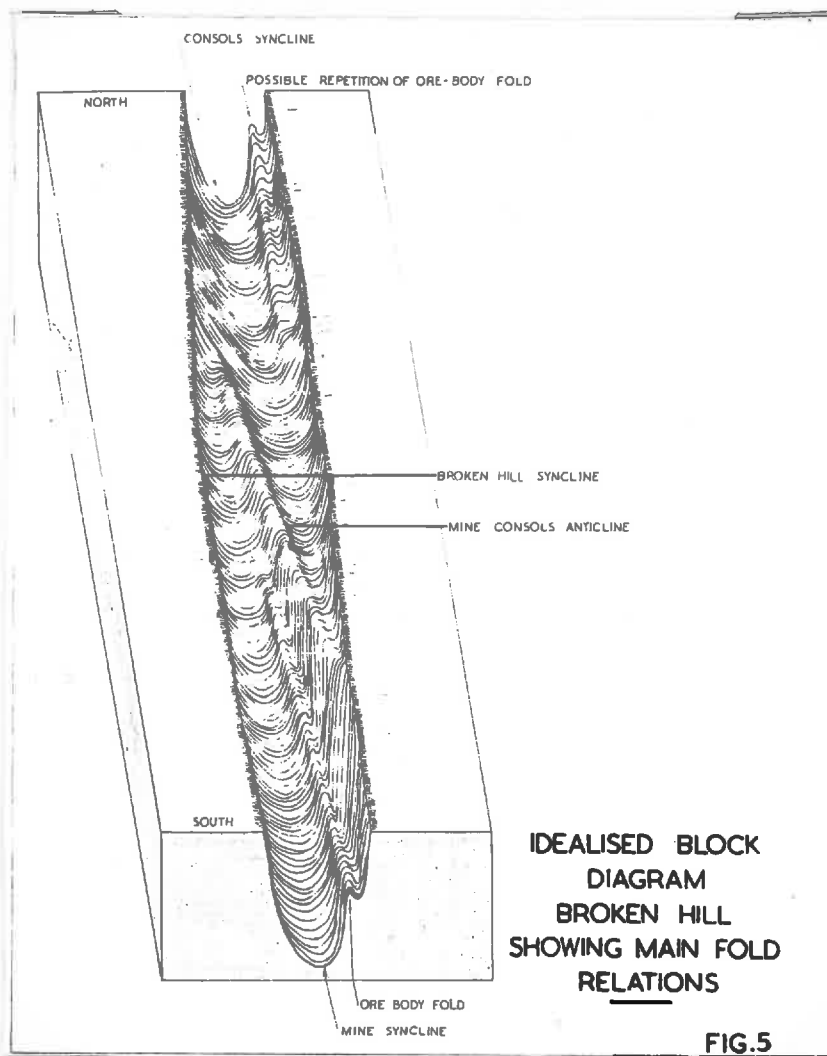

Figure 5.

These drags appear on the eastern limb of a syncline termed the "Mine" Syncline. The ore body consists of a number of complex minor folds following a right-hand en echelon pattern. This can be seen clearly on cross-section (2), through Delprat, where the major structure is synclinal ("Mine" syncline).

A glance at the C.G.S. cross-section (1) shows the essential difference in interpretation: The dominant structure here is anticlinal. Cross-section (2) is just a 1" = 2000' equivalent of the 400 scale cross-section "BB" which was discussed earlier. The detailed rock succession has been modified retaining only distinctive horizons, for convenience.

The British and De Bavay faults interrupt the trend of the main ore body. These structures had been interpreted as simple faults by C. G. S. et al, but Lewis has rejected the simplicity of this viewpoint. The intense sericitisation of beds in these zones has suggested a considerable amount of rock flowage. Interpretation of the zone at De Bavay strongly suggested a tight en echeloning in the "Mine" syncline, with little or no rock fracturing. A definite fracture zone has been mapped to the east in Hanging wall Gneiss, where the gneiss has been dragged into a well-defined shear zone. (See the sketch below). Both the British and De Bavay "faults" are fractures on the eastern side, but merge into folds to the west. These folds from en echelon positions in the main syncline. On the eastern side of the sheared block deformation resulted in fracturing, but on the west the same deformation produced folding. The eastern fractured area has itself been folded and it is suggested by Lewis that the block was at first generally folded, but with increased intensity the rocks in the east became faulted and those to the west were more severely folded.

A stress analysis of this area must be concerned with the Globe Vauxhall "crush zone" also. This is a zone of sericitisation with a maximum width of several hundred feet, but usually of the order of 100'. It has been referred to in a discussion of faulting per C.G.S. Lewis suggests that it represents one of the major planes of relief to a major north block west shearing couple. Thus the Globe Vauxhall is a shear zone resulting from the same couple that caused the en echelon folding, and the British and De Bavay fractures. The stress analysis diagram figure 4 will explain this in greater clarity.

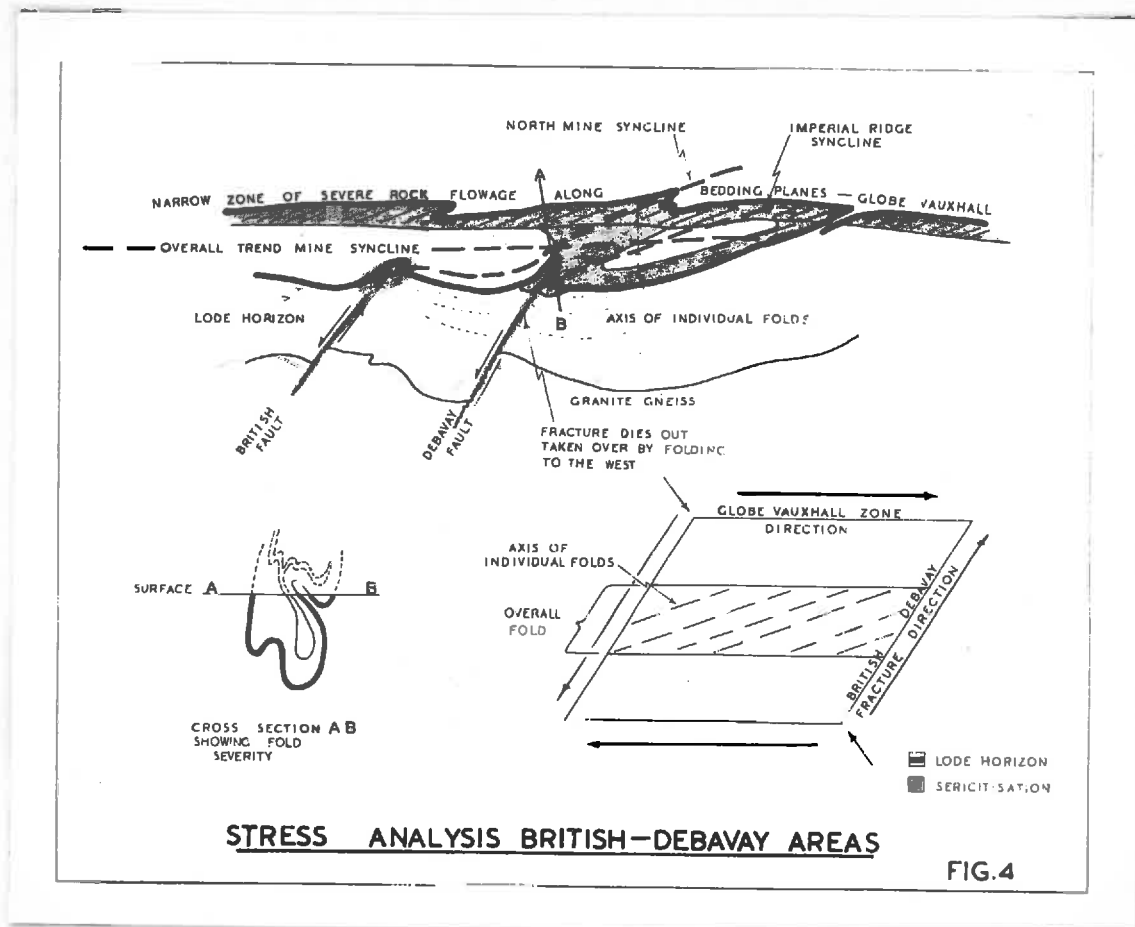

Figure 4.

The "Mine" syncline is made up of a number of en echeloning synclines. In the British area, the North Mine ore body is simply an en echelon repetition of the southern ore body. The "Zinc - B.H.S" syncline dies out going north, and its place is taken by the "North Mine" syncline. Zinc and B.H.S. ore bodies lie on a drag on the eastern flank of the "Zinc - B.H.S." syncline. The ore-bearing drags on the "North Mine" syncline also occur on its eastern flank. The "North Mine" syncline dies out in the De Bavay region, but its en echelon position is the "Imperial Ridge" syncline.

In the south of the field the main ore body appears to be waning. The "Zinc - B.H.S", syncline is climbing on a north pitch ahead of the ore body, and further ore might be expected on the flank of the "Rising Sun" syncline.

East of the Delprat Shaft area, a second major fold, the "Consols" syncline has developed. This increases in development going north at the expense of the "Mine Syncline". In the "Consolidated-Barrier Main Lode" area to the north, the "Mine" syncline has almost disappeared, and the "Consols" syncline has completely taken its place. New ore to the north must of course be related to this structure.

In Conclusion

Reviewing these ideas it is difficult to envisage any changes in structural concepts as complete as those made by Lewis. En Echelon folding is in itself still an unknown quantity to most geologists, and although the theory and mechanism is relatively simple the actual detailed fold patterns, changes of pitch, etc. are by no means simple. This structural interpretation has explained many puzzling facts of Broken Hill Geology and certainly fits the facts better than past ideas did.

PART II.

PETROLOGICAL ASSISTANCE IN SOLVING BROKEN HILL STRUCTURES

These latest ideas on the structures and rock succession have had no micropetrological backing, and Lewis suggested to the author that a comprehensive study of the rock types, especially the granitic gneisses, would be of some assistance in confirming structural interpretations. The three pseudo-Potosi gneisses, and two pseudo-Hanging wall Gneisses were treated in separate sections which follow this text.

Recent work has suggested that the Pinnacles lode is in the same stratigraphic position as the main Broken Hill lode. Lode types, garnet quartzites, etc., are common to both positions, but there is a development of aplite rather than "quartzite" at the Pinnacles. Whilst some B.I.F. occurs, most of the iron-rich rocks are quartz-magnetite types, banded or unbanded. A microscopic examination of aplites and felspathic quartzites, supposedly of the same horizon, outcropping over rather widely separated areas was made. This aimed at a possible petrological correlation.

Two problems of structural interest are the transition from Hanging wall Gneiss "B" to amphibolite on cross-section "AA", and an apparent change of sillimanite gneiss to sericite schist in areas of intense deformation. A discussion of these transitions will not be made in the following section, but is reserved for a later treatment under "A Discussion on the Origins of Rocks close to the Mainlode".

The three main petrological structural problems are:—

1. The problem of the Potosi Gneisses.
2. The Hanging wall Gneisses.
3. A study of Broken Hill Aplites.

They are reviewed in that order.

1. THE PROBLEM OF THE POTOSI GNEISSES

This consists of a microscopic examination of rock types closely resembling Potosi-Footwall Gneiss but supposedly belonging in three distinct stratigraphic horizons. Petrological confirmation of visual differences between these rocks was sought in order to strengthen the structural interpretation. As can be seen from the cross-sections, one gneiss lies above the lode horizon, and two below. These rocks exhibit only rudimentary gneissic banding, and are garnet-feldspar-quartz granulites.

They differ from the Hanging wall Gneiss in that they are but crudely banded and decidedly more granular. In addition, garnet is very much more dominant, and is often rimmed by dark brown biotite, the so-called "biotite halo".

These gneisses were conveniently called Potosi Gneiss "A", "B", and "C", with "A" the lower horizon, and "C" the upper, above the lode channel. Potosi Gneiss "C", immediately above the lode horizon has been recognised and described by early geologists at Broken Hill. It is regarded as the "true" Potosi Gneiss, "A" and "B" being distinct variants of this rock type.

A microscopic study of these rocks has revealed that differences lie mainly in the proportions of the essential minerals, rather than in any unusual change in mineralogy. For this reason it is possible to describe an "ideal" Potosi Gneiss in terms of texture and mineralogy and discuss variations in the relative proportions of minerals present in the light of the collected microscopic data.

Description of a Potosi-like Gneiss.

Potosi Gneiss is a rather coarse-grained granulite, the chief components of which are orthoclase, quartz, plagioclase, biotite and garnet, with subordinate, rare sillimanite.

Garnet (almandine) grains are commonly porphyroblastic, but mostly poorly formed and with rounded outlines. Inclusions of quartz grains are plentiful, and these garnet crystalloblasts are usually much altered between cracks and at the edges to biotite, chlorite and sericite.

An indistinct gneissose structure is imparted on the rock by aligned flakes of biotite. This mineral is normally a rich brown, strongly pleochroic variety, of variable crystal habit. In some cases the flakes are large and well-defined, but more often it occurs as small ragged flakes, or as aggregates of these recrystallised from larger plates.

Biotite haloes around large pink garnets are characteristic of the rock. These are largely caused by a segregation of aligned biotite aided by the rapid growth of the garnet. Peripheral alteration of the garnets is quite apparent, but the pushing-aside of biotite masses to form a thicker layer gives a false impression of the degree of alteration.

The proportion of potash felspar to plagioclase varies, but on the whole, plagioclase is more abundant. The composition however, is variable, although most species lie

between oligoclase and labradorite. Recrystallisation is apparent from the granoblastic nature of the matrix, but this has not eliminated multiple twinning of the plagioclase, which is frequently clear and sharp, permitting an accurate determination of the composition. Alteration of plagioclase is not marked, but sericitisation of potash feldspar commonly occurs.

There is no doubt that, whatever the origin of this gneiss might have been, that rock has subsequently suffered intense metamorphism and recrystallisation. In addition, retrograde metamorphism has occurred; with the alteration of orthoclase to sericite or fine-grained muscovite, sillimanite developing a border of sericite, and large garnets changing to biotite, sericite and chlorite.

At this stage it is desirable to point out differences in the three Potosi-like gneisses which are quite obvious even in the hand specimen.

Hand Specimen Differences

1. Potosi Gneiss "A"

This rock contains more biotite than "B" or "C", and has a more pronounced foliation. Also, it is more feldspathic, so that in fact it resembles Hanging wall Gneiss more closely than Potosi Gneiss. However, Potosi "A" contains abundant pink almandine porphyroblasts which are but weakly sericitised. Biotite haloes about these garnets are common. The biotite banding is decidedly weaker than that of the Hanging wall Gneisses.

Thus, summarising differences:

- (a) A relatively high biotite content imparts on the rock a coarser and distinct foliation, not apparent in "B" or "C".
- (b) Biotite-rimmed garnets are numerous.
- (c) The rock is more feldspathic than "B" or "C", although pegmatitic veining is rare.

2. Potosi Gneiss "B"

Potosi "B" is a granular rock with little or no biotite banding. However, pegmatite veining is marked, and feldspars are dominant minerals. Garnets vary considerably in size, but the shape is consistently spherical and in no way elongated. Marginal alteration of garnets to biotite is common, and very obvious in the hand specimen. Biotite is thus abundant as haloes about almandine porphyroblasts, but rarer in the pegmatitic matrix. The rock is a siliceous granulite, with blue quartz abundant in most specimens.

Again, the main features are:

- (a) Only a faint directional texture, similar to "C", but much weaker than "A". This is coincident with a lower biotite content.
- (b) A relatively high feldspar content which matches that of "A", but is very much higher than that of "C".

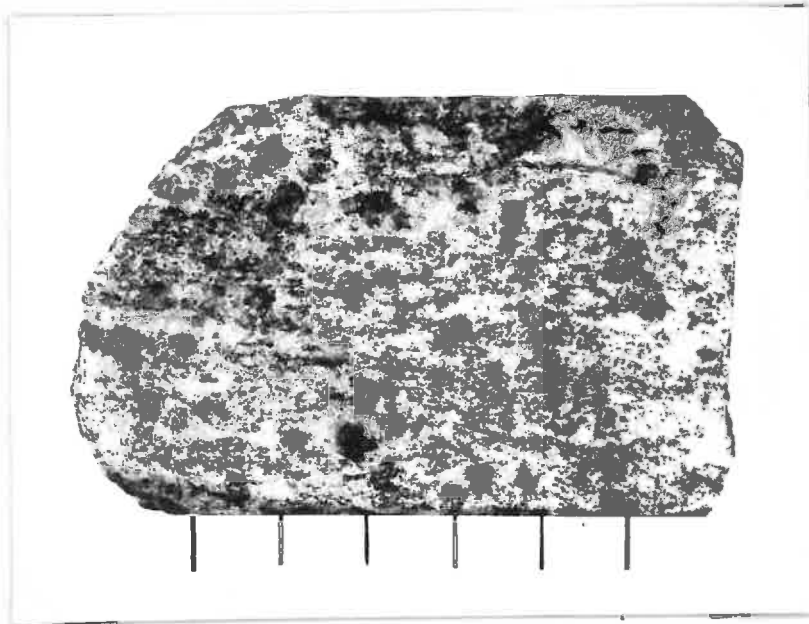

Figure 6 - Potosi Gneiss "B"

Photograph of the hand specimen of A139/97, Zinc Corporation, showing faint gneissic texture and granular almandine garnets with characteristic biotite "haloes". The surface is normal to the foliation. Each division of the scale represents 1 cm.

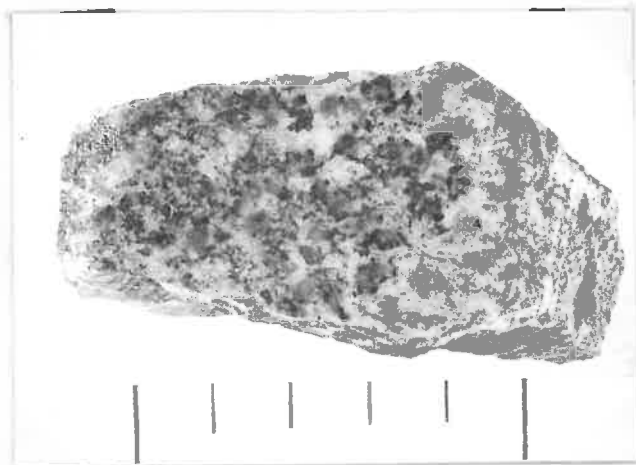

Figure 7 - Potosi Gneiss "B"

Some specimen, with surface parallel to the foliation.

3. Potosi Gneiss "C"

Hand specimens of this gneiss are distinctive. It has a pronounced granoblastic texture with a faint trace of foliation. Feldspar-quartz veining, characteristic of "B" is rare, and the overall texture is homogeneous. It is thus less pegmatitic than "B", more siliceous and less feldspathic. Garnets are similar in size to those in Potosi's "A" and "B" (about three millimetres in diameter is average) and biotite is notably deficient. Haloes about the garnets, characteristic of "A" and "B" are but weakly developed. The rock is very siliceous, and contains correspondingly less feldspar.

Thus summarising physical properties:

- (a) Relatively small garnets occur.
- (b) Texture is faintly directional: stronger than "B", but considerably weaker than "A".
- (c) A poor development of biotite.
- (d) Highly siliceous matrix.

From these observations it was possible to make a constructive microscopic comparison of these rock types, with reasonable clues as to what must be looked for under the microscope. The thin sections were examined with the idea of collecting data on:-

- I Structure and texture
- II Mineralogy
- III Grain size

Representative thin sections are described under the title of "Rock Descriptions", within the Potosi Gneiss sub-section.

Conclusions

Certain conclusions were made on the basis of this treatment.

I Structure and Texture

It would be convenient to define these terms before proceeding further. By "texture" is meant the mutual relationships between metamorphic minerals, and this depends on shapes of minerals, mode of growth, and mutual arrangement. The "structures" depend on the inter-relations of various textures within the same rock unit.

(a) Textures

(i) Shapes of minerals

No important differences were observed from a

study of the shapes. Most of the dominant minerals, such as quartz, plagioclase, orthoclase and garnet have an equidimensional habit. In a few instances there has been an elongation or flattening of these minerals, particularly quartz (which has developed an undulose extinction), but this has not been confined to one species of Potosi Gneiss. Both biotite and sericite are flaky in crystal habit, and sillimanite is characteristically needle-like. Zircon, usually quite rare, always occurs as small, usually elongated grains, with rounded edges.

(ii) Growth

Recrystallisation in all gneisses has been almost simultaneous, and there is no real order of crystallisation. Individual crystals enclose each other quite indifferently. Thus all three gneisses contain no zoned plagioclase. Myrmekite, however, occurs throughout. Garnet porphyroblasts probably grew at a faster rate than neighbouring quartz and feldspar grains. Inclusions of quartz are common in all garnets.

(iii) Mutual Relationships

Relationships between minerals are the same in all three gneisses. Thus quartz and feldspar grains are always more rarely sericite) are idioblastic.

(b) Structures

Important differences distinguish Potosi Gneiss "A" from "B" and "C" here. "A" has a more strongly developed gneissose structure due to alteration of thin folia and biotite with coarse and wider segregations of quartz and feldspar. This does not imply a strong gneissosity. Actually this gneiss is a gradation between granulose and gneissose structures. Potosi Gneisses "B" and "C" are considerably more granulose, with only a faint trace of gneissose structure. This structure, in Potosi "A", is coincident with an increased biotite content.

II Mineralogy

Since these gneisses have all been likened to a prototype Potosi Gneiss (actually "B"), one would not expect to find startling mineralogical differences, and indeed this is found to be the case. However, consistent variations do occur in the relative proportions of minerals present, and these will now be dealt with at length.

1. <u>quartz</u>	Content	"A"	50% in most thin sections, but may be as low as 40%.
		"B"	60% - 65%
		"C"	50%-60%. In the case of "C" this figure is more variable, a minimum estimation being 40% and the maximum of 65%.

Colour

Quartz may be clear, smoky or blue, and Potosi Gneisses "B" and "C", more siliceous rocks, and closer to the lode channel, normally contain blue quartz.

2. plagioclase

The % of plagioclase in the rock, and its composition is of interest here.

Gneiss	% plagioclase	Composition
Potosi Gneiss "A"	25%-35%	andesine
" " "B"	rather variable from 10%-25%	andesine - labradorite. (usually the latter).
" " "C"	5%-10%	more calcic labradorite.

3. orthoclase

Potosi Gneiss "A"

% orthoclase

difficult to estimate.

" " "B"

variable, but in most cases deficient, with excess plagioclase.

" " "C"

5%

Intense sericitisation, with alteration of orthoclase to sericite, makes this comparison spurious.

4. sillimanite

This is most abundant in Potosi Gneiss "B", and occurs very rarely in "A" and "C". It is nearly always a relic mineral, and has altered in the majority of cases to sericite.

5. garnet

The garnet of these gneisses is a light pink colour, and is almandine. Garnet is plentiful in all three gneisses, and it is not possible to make a distinction here. Alteration is inconsistent, and cannot be used as a guide.

6. sericite

The degree of sericitisation may provide a lead as to the relative potash content of the gneisses, although biotite must be taken into account. Orthoclase is somewhat minor in most thin sections (about 5% - 10%) and may be considered to be relatively constant. Since sillimanite has also altered to sericite the estimate would be fairly doubtful.

In fact it is difficult to separate "B" and "C", for both are severely sericitised, with large flakes visible in the hand specimen. "A" is less sericitised.

7. biotite

Biotite occurs in all three gneisses as fairly large ragged flakes of varying colour. In many cases it is a rich brown, containing a high percentage of iron, but occasionally a distinct reddish tinge is apparent. It is never green, unless marginal alteration to chlorite (rare) has given this impression. A distinction cannot be made between these gneisses on the basis of the colour of their biotites. The relative proportions, however, are characteristic. Biotite is more abundant in Potosi Gneiss "A", and occurs as larger flakes. No distinction can be made between "B" and "C".

8. Rarer Minerals

These occur consistently throughout all three rock types. Zircon and apatite are ubiquitous, but magnetite, pyrite, pyrrhotite, ilmenite and galena are sporadic in occurrence.

III Grain Size

This is inconsistent even within one particular gneiss, and is not a safe basis for comparison. A consideration of grain diameters may have been made here if such was warranted. The minerals involved would have been quartz, feldspar, biotite, garnet and zircon. These data were collected, and appear in the rock slide description sections.

In Conclusion

The above evidence suggests that these gneisses are different petrologically. Mineralogical differences do not exist, but the relative proportions of minerals present in each gneiss are consistent within that gneiss and decidedly different from those of the other gneisses. The subtle differences in the hand specimens of these rocks have been confirmed microscopically. This supports the structural interpretation of three separate and distinct horizons of Potosi-like gneiss.

2. THE HANGING WALL GNEISSES

This problem is of the same nature as that concerning the pseudo-Potosi Gneisses. Specimens of Hanging Wall Gneiss "A" and "B" were collected from surface outcrops and diamond drill core and thin sections were cut of this material. Before stating microscopic differences between the two gneisses it would be convenient to compare typical hand specimens.

OBSERVATIONS ON HAND SPECIMENS OF HANGING WALL GNEISS
"A" AND "B"

1. Hanging Wall Gneiss "A"

The rock consist chiefly of feldspar, quartz and biotite, with large porphyroblastic feldspar augen. It has a pronounced gneissose structure, emphasised by a strong development of compact, foliated black biotite which occurs as thin layers separated by a highly feldspathic matrix. Sericite and biotite are usually both plentiful, with sericite slightly subordinate to biotite. Hanging wall Gneiss "A" contains practically no visible garnet; knots of sericite seem to have replaced pre-existing garnet, so that only relics are left.

Thus the main points are:--

- (1) highly feldspathic matrix
- (2) abundant black biotite and subordinate sericite.
- (3) deficiency of garnet (almandine)
- (4) a strongly gneissic texture

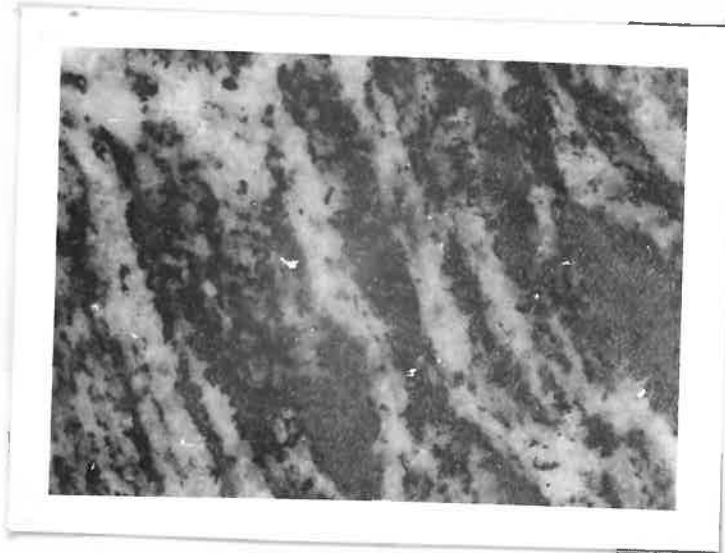

Figure 8 - Hanging Wall Gneiss "A".

Photograph X2 of a wet polished section of A139/7. The surface was cut at 70° to the plane of foliation. Biotite banding is slightly exaggerated, but the photograph shows clearly the alteration of layers of quartz-feldspar and biotite-sericite, typical of this gneiss. Garnet is absent.



Figure 9. Hanging Wall Gneiss "A".
Same specimen photographed dry on a curved surface of the B.D. core.

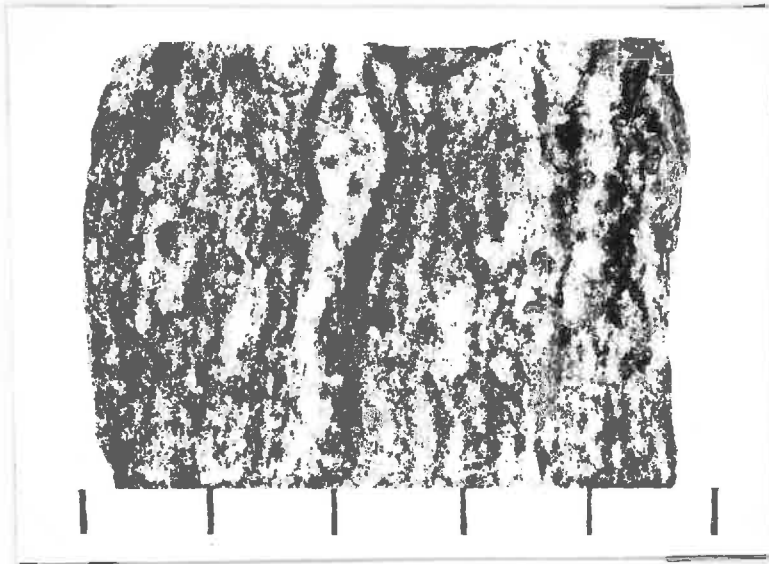

Figure 10 - Hanging Wall Gneiss "A".

Photograph X2 of a surface of core specimen Al39/5 cut normal to the foliation. Strong biotite banding and subordinate streaky sericitisation are apparent. No garnet is present. A 1 cm scale gives some idea of the width of bands.

2. Hanging Wall Gneiss "B"

Hanging wall Gneiss "B" would be more precisely classified as a banded or gneissic feldspathic quartzite. Long seams of fine-grained white marble visible in the core resemble sillimanite, but are largely masses of retrograde sericite mica. Large but irregularly shaped almandine garnets abound, and these have been altered partially to biotite, sericite and chlorite. Most are elongate and stretched-out along poorly defined planes of schistosity. The rock is notably siliceous, abundant coarse-grained blue quartz predominating. Gneissic texture is again strongly evident, and biotite is abundant.

Again, the main features are:-

- (1) siliceous nature, with minor feldspar.
- (2) abundant biotite.
- (3) large irregular pink garnets (almandine).
- (4) streaks of sericite and possibly relic sillimanite.

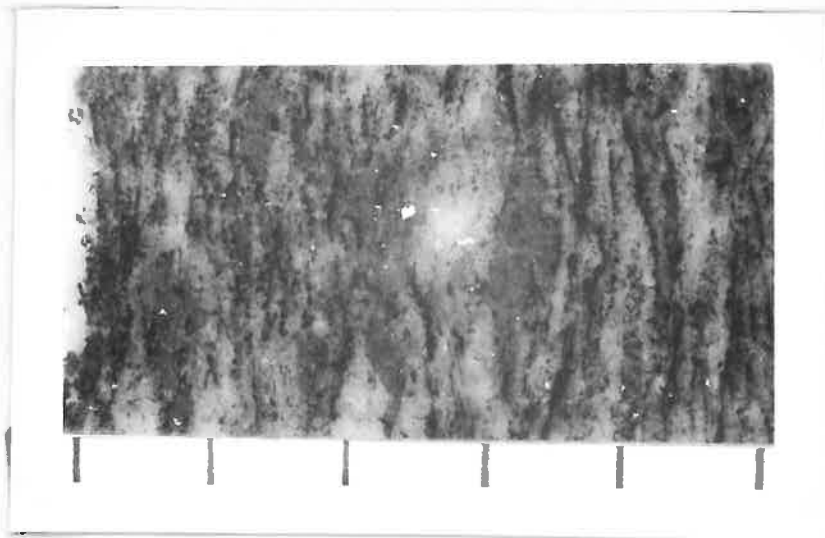

Figure 11 - Hanging Wall Gneiss "B"

Photograph of specimen Al39/83, North Mine core, showing thin biotite banding, elongate garnets, and layers of quartz-felspar. The surface was cut approximately normal to the foliation, and photographed wet. Divisions on the scale represent 1 cm.

Hence from the hand specimens, differences in mineralogy and texture are rather obvious. Hanging wall Gneiss "A" is more feldspathic, and "B" very much more siliceous. Hanging wall Gneiss "A" has a greater percentage of biotite. However, the iron content of these rocks might be almost identical because of a correspondingly greater development of almandine in "B". Gneissic biotite banding is stronger in "A" than "B". An important distinction is the absence of sillimanite in "A", but a minor occurrence, almost completely altered to sericite, is apparent in "B".

A COMPARISON OF HANGING WALL GNEISSES "A" & "B" FROM THIN SECTION EVIDENCE.

The method of attack is the same as that adopted in the Potosi Gneiss section. For example:-

- (I) Structure and textures
- (II) Mineralogy
- (III) Grain or particle size

Again, representative thin sections on which the conclusions are based have been described in "Rock Descriptions", within the Hanging Wall Gneiss sub-section.

CONCLUSIONS

I. Structure and Textures

(a) Textures

(i) Shapes of minerals

Quartz crystalloblasts are normally inequidimensional

and exhibit undulose extinction in Hanging Wall Gneiss "A". This applies particularly to larger grains. Elongation, with the long axis paralleling always irregular in outline. This is true also of Hanging wall Gneiss "B", but grains are not consistently elongated, and are often equidimensional. No distinction can be made between feldspars (plagioclase and orthoclase, but no microcline) of the two gneisses. Most grains are xenoblastic and equidimensional, although there is a slight tendency in Hanging wall Gneiss "A" for the grains to be strained, as manifested by curved multiple twin planes. Biotite flakes are usually ragged, and the mineral may occur as large individual crystals or as aggregates of smaller ones. The crystal form is similar in both gneisses. This also applies to sericite, which occurs as minute leaflets of random orientation. Sillimanite restricted in occurrence to Hanging Wall Gneiss "B" is idioblastic, with well-developed prism faces. It is needle-like, and individuals show a parallel alignment. Magnetite and zircon are not abundant, but the former is generally irregular in shape. Rounded outlines are characteristic of the zircons.

(ii) Growth

The xenoblastic nature of dominant minerals indicates simultaneous growth during recrystallisation. Both gneisses have been metamorphosed, and no differences were observed here.

(iii) Mutual relationships

The only feature worth of comment here is the characteristic inclusions of quartz grains in garnet porphyroblasts. Adjacent layers of aligned biotite have been pushed aside. This is also noticeable in the Potosi Gneisses. According to Ramberg the explanation lies in the fact that the interfacial energy between garnet and biotite is great as compared with the garnet-quartz interfacial energy. Joints of garnet-quartz may function as birth places for the new surface layers to be built on the growing garnet, such that the garnet will gradually completely enclose the quartz grain.

(b) Structures

Both rocks show a strong gneissose structure, but Hanging wall Gneiss "A" is coarser, with no gradation into granulose structure. Biotite is abundant in Hanging wall Gneiss "A", and folia are continuous, so that segregation of layers of quartz-feldspar and aligned biotite is pronounced. A somewhat lesser biotite content in "B" makes the rock appear relatively more granulose in handspecimen, an observation supported by microscopic examination.

II. Mineralogy

Marked differences in the hand specimens suggest essential differences in mineralogy, and this was found to be the case.

1. Quartz

Content	"A"	30-40% in most thin sections (with a minimum of 30%)
	"B"	50-60%, with a minimum of 45% and a maximum of 65%.

Colour. Blue quartz may occur in "B", but never in "A". Thus Hanging Wall Gneiss "B" is very siliceous, considerably more so than "A". This fact was fairly obvious in hand specimen.

2. Plagioclase

Hanging Wall Gneiss	% plagioclase	composition
"A"	20-25% but may be as low as 10% and as high as 30% in the extremes	oligoclase - andesine
"B"	5-10%	oligoclase, but occasional by more calcic. (andesine).

It can be seen that "A" is more feldspathic than "B" as regards plagioclase, but no distinction can be made as regards composition. Both gneisses consist of plagioclase within the range oligoclase to andesine.

3. Orthoclase

Sericitisation renders the estimation of the percentage of orthoclase present of little importance, but it is considered that orthoclase is equally as abundant as plagioclase in Hanging wall Gneiss "B" (about 5-10%). However, plagioclase is the dominant feldspar in Hanging wall Gneiss "A", with subordinate orthoclase. It is noteworthy that microcline and other feldspars and other feldspars are very rare in these gneisses.

4. Sillimanite

Needles of idioblastic sillimanite are consistently present in specimens of Hanging Wall Gneiss "B", but rare to absent in "A". Most prisms are relict, and have been intensely sericitised. This sillimanite is regarded as a point in favour of the originally sedimentary nature of "B".

5. Garnet

The composition is almandine. Garnet is abundant in "B", but rare in "A". Garnets in "A" have been severely altered, largely by processes of sericitisation, but also to chlorite and biotite. Large masses of sericite, consisting of aggregates of

tiny flakes engulf fragmented relic garnets. Sericitisation of the garnets is not as marked in "B" alteration to biotite is but minor.

6. Sericite

Hanging wall Gneiss "B" has not suffered intense sericitisation. Many thin sections contain sericite as an alteration of sillimanite and garnet, but the essential difference lies in the relative content of feldspar, and more particularly, orthoclase. Large areas of "A" have been sericitised, and it is probable that these areas were potash feldspar, a fact supported by minute ubiquitous relics of orthoclase. The greater the initial potash feldspar content, the more apparent would be the sericitisation.

7. Biotite

This mineral might comprise 20% of "A" but is much less abundant in "B", although still a dominant mineral. There is no observable difference in colour, pleochroism or crystal habit. A reddish tinge is apparent in some species, but this is not consistent within the same gneiss.

8. Accessory Minerals

Magnetite, ilmenite, apatite and zircon are common to both rocks. No distinction can be made on this basis.

III. GRAIN SIZE

The average grain diameters of quartz and feldspar xenoblasts in both gneisses are similar - about 1 mm. Biotite flakes of "B" are usually larger than those of "A", where the biotite occurs often as folia consisting of aggregates of small ragged flakes, possibly recrystallised from larger flakes. Garnet is rare in "A", but numerous porphyroblasts characterise "B". Crystals range from $\frac{1}{8}$ " to $\frac{3}{8}$ " in diameter. Occasional elongated grains are $\frac{1}{2}$ " in length, but fairly narrow. On the whole "B" appears to be coarser grained than "A".

In conclusion

As can be seen from the foregoing comparisons, these gneisses are different rock types. Chemical analysis should point to a similar conclusion. The difference in mineralogical composition is due to a difference in bulk chemical composition.

3. A STUDY OF BROKEN HILL APLITES

Thin sections were cut of about twenty specimens of aplite from the Broken Hill district. Six of these were diamond drill core specimens from the South Mine and Laurel No. 2 hole. The remainder consist of unweathered surface outcrop rocks covering a wide area. Thus aplites were collected from the Great Vugh area,

Thackaringa, Pennacles, Big Hill, Redan, and again from exposures underground on 12 level, South Mine. Several specimens came from each outcrop area, and since these have proved to be microscopically identical, it was found desirable to include only one description of each type in the "Rock Descriptions" section.

Very few of these aplites appear similar in the hand specimen. All are fine-grained, but there are many variations even here. The finest grained types are very dense and massive, and individual grains cannot be detected, with the hand lens. These rocks resemble silicified quartzites. They fracture sub-conchoidally and possess a perfectly homogeneous texture. In the other extreme is a sugary material, consisting of small equidimensional grains of quartz and feldspar whose grain outlines are distinct and recognisable by the naked eye. These have an uneven fracture and are usually softer than the finer-grained species.

The textures and structures in all cases point to a recrystallisation, but the nature of the original material is doubtful. Past and present ideas on the origin of these rocks will be discussed at a later stage, but one fact is quite clear; these rocks are perfectly conformable with the major Broken Hill rock types. This was realised by E. C. Andrews as far back as 1922 when he referred to the sill-like and lensy nature of the aplite belts, particularly those at the Pinnacles and Thackaringa districts. He regarded these rocks as igneous in origin, and intimately related to granite older than the Broken Hill-type lodes. However, most of the aplites exhibit a granoblastic texture, indicative of metamorphic recrystallisation in the absence of any marked stress or directed pressure. Quartz and feldspar crystalloblasts are xenoblastic and equidimensional, and show no apparent elongation or preferred orientation.

Not all aplites are granulose. Banding, often made more pronounced by a higher biotite content, has emphasized the gneissose structure of some of these rocks. This is generally very faint, but elongation of quartz grains, and to a lesser extent of feldspars, shows as an obvious lineation in thin section. Aplites situated close to the main body of the Broken Hill Lode have been sericitised. Slight recrystallisation during sericitisation must have occurred, but the main effect is the exaggeration of gneissic texture by the development of long seams of sericite. However, preferred orientation of biotite, even if this mineral is relatively sparse, is the best guide to gneissose structure. In addition, some aplites contain a notable percentage of magnetite and ilmenite, and these minerals may occur as long strings of crystals, which accentuate the banding.

MINERALOGY OF THE APLITES

The mineralogical composition of the aplites is extremely variable, but quartz and feldspars are the chief components. The feldspars consist of plagioclase and orthoclase, with no microcline. The relative proportions of these minerals present in each aplite is of little use in an attempted correlation because of the extremely variable results, even in aplites closely spaced with respect to one another. Again, the composition of the plagioclase proved of no real aid because of local inconsistencies.

1. Quartz.

The percentage of quartz varies from approximately 40% in the more feldspathic aplites to a maximum of 70% in the "quartzitic" varieties. Specimens from South Mine core are not true aplites, but should be known as garnet-quartzite, epidosite-quartzite, plagioclase-biotite quartzite and the like. In no instance was feldspar present in sufficient quantity for the rock to be classified as aplite. In each of these rocks the quartz content was greater than 60%. The Laurel No. 2 D.D. hole specimens contain 65% quartz, but a low feldspar content, coincident with fairly abundant garnet. It is a garnet-feldspar-quartz granulite, rather than an aplite. The specimens from Thackaringa, the Pinnacles, Big Hill and Redan are true aplites, and the percentage of quartz ranges from 45% to 60%. These rocks contain a high percentage of feldspar, and very little garnet, biotite and sericite.

2. Plagioclase.

This is nearly completely absent in the garnet quartzites, but reaches a maximum of 40% in Pinnacles aplite. The above mentioned aplites of Thackaringa etc. consist largely of plagioclase with subordinate orthoclase. Thus a minimum would be 25% with a maximum percentage of 40%. In most cases the composition is that of andesine or oligoclase.

3. Orthoclase

Orthoclase is subordinate to plagioclase in all the aplites. Redan aplite contains the two feldspars in approximately equal proportions. Other aplites have plagioclase at least 10% greater than orthoclase. The South Mine quartzites etc., show a reversal here. However, orthoclase itself is never abundant, and usually less than 5%. Sericitisation, which is most intense in these rocks, excluding garnet quartzite and epidosite, must have been at the expense of much potash feldspar. It is noteworthy that the aplites from Thackaringa, Pinnacles, Big Hill and, to a lesser extent, Redan, show similar relationships between potash feldspar, plagioclase and quartz as regards their relative proportions. Intergrowth and

eutectic relationships between orthoclase and plagioclase are not apparent. Also, microcline, a common constituent of many feldspar-rich metamorphic rocks is entirely absent.

4. Sericite

Most of the rocks examined are slightly sericitised. Epidosite quartzite and garnet quartzite contain no sericite at all. This also applies to several aplites from Thackaringa and the Pinnacles districts. Apart from these instances, partial sericitisation, particularly of orthoclase, was recorded in the other specimens. Big Hill and Pinnacles aplites are slightly sericitised, with little or no alteration of the plagioclase, but sericite is rare in the Redan aplites.

5. Biotite

This occurs in specimens from the South Mine, Laurel No. 2 hole, and is a minor mineral in Thackaringa and Pinnacles aplites. Other aplites, those of Redan, Big Hill and a few sections from the Pinnacles contain no biotite. Naturally enough, the more gneissic aplites are the ones richer in biotite. The mineral is very fine-grained but in most cases shows a preferred orientation. It is reddish-brown, iron-rich, and strongly pleochroic.

6. Garnet

Almandine garnet is present in some rocks of aplitic appearance from the South Mine. However, none of the aplites from Thackaringa, the Pinnacles, Big Hill and Redan contain garnet.

7. Sillimanite.

This mineral was detected in a rock from the South Mine. The occurrence was limited to a few specimens that were not true aplites, but really metasomatic feldspar "quartzites".

8. Ziosite, epidote

Again, as in the case of sillimanite, epidote minerals appeared only in the epidosite quartzites close to the main lode channel.

9. Accessory Minerals

Ilmenite, magnetite, pyrite and rutile are of importance as constantly occurring accessories. The first two are widespread throughout. Pyrite and rutile are of more significance. The former is very abundant in Big Hill aplite and appears in material from the Pinnacles and in the more "lody-type" aplites from the Laurel No. 2 hole as well, and in South Mine aplites. Thackaringa and Redan aplites contain no pyrite. Rutile occurs as small, often perfect, idiomorphs in rocks from Thackaringa,

Pinnacles, and Big Hill. It is absent in the Redan aplite and in the South Mine and Laurel specimens.

CONCLUSIONS

Mineralogically and texturally the aplites from Thackaringa, the Pinnacles and Big Hill are almost identical. In the face of structural evidence which strongly suggest correlation it is possible to state that the micropetrology of the rocks will support such an interpretation.

The same cannot be said for the aplites and quartzites from Redan, Laurel No. 2 hole and the South Mine. These rocks are distinctly different in thin section, as indeed is also true of the hand specimens. However, the petrology does not prove altogether that these rocks are not of the same stratigraphic horizon. Unfortunately the problem rests on the question of origin, which even after so many years of research still does not stand above controversy. The important question to be answered is whether a metasomatic garnet-quartzite at Broken Hill could be an aplite further afield, say as far away as the Pinnacles or Redan, where the metasomatism and chemical exchanges between lode ⁽¹⁾intense. It must be emphasised that the essential difference between these rocks is that of garnet and plagioclase content. However, Stillwell and Edwards have examined Broken Hill uralite dolerites in which plagioclase was quite definitely in the stage of being replaced by garnet. This was interpreted as a change brought about by lode metasomatism, with the introduction of iron and manganese ions into the dolerite.

e.g.

Ca plagioclase + (Mn, Fe) (Mn, Fe, Ca) Garnet + sodium silicate.

If a large percentage of the garnet in these garnet quartzites was replaced plagioclase, then the composition originally would have been close to that of the aplites further afield. However, this is mere conjecture, and no evidence of any replacement was observed in thin section. The deficiency of potash feldspar in these garnetised quartzites could be explained on the basis of relative sericitisation. Orthoclase close to the lode is nearly always relict, and is engulfed in matted fine-grained sericite. Away from the main lode development this sericitisation is but minor, and orthoclase has been largely preserved. Thus it is difficult to estimate the relative amounts of orthoclase prior to sericitisation. Of course any introduction of potash which must have occurred for the sericitisation of sillimanite, would render such speculations completely indefinite. The epidosite quartzites can be regarded in the same light. Conditions were so

complex, and the degree of metasomatism of such variability that no ready answers to these problems are available.

Sillimanite is another problem. This occurs rarely in the aplitic "quartzites" exposed in the mines at Broken Hill, but is completely absent in aplites further afield. The first occurrence testifies to a sedimentary origin of these aplitic quartzites, supported by other features, but it is not at all certain that these other aplites were originally sediments, modified by intense metamorphism, with or without diffusion of material.

In conclusion, the situation is as follows. Aplites from Thackaringa, Pinnacles and Big Hill can be regarded as belonging to the same stratigraphic horizon. Petrological evidence does not support a correlation with the feldspathic "quartzites" of Broken Hill proper. Redan aplite is a true aplite, and the textures and mineralogy resembles those at Thackaringa etc. However, accessory constituents, highly distinctive in the above rocks, are absent in the Redan specimens. Any correlation would be extremely tentative.

(1) Channel and adjacent rocks has been less.

PART III

A DISCUSSION ON THE ORIGINS OF ROCKS CLOSE TO THE

MAIN LODE.

1. Banded (bedded) Iron Formation
 2. Amphibolites
 3. The Sillimanite Gneisses
 4. Sericite Schists.
 5. Plagioclase "Quartzites"
 6. Potosi Gneiss
 7. Hanging Wall Gneiss
-

1. BANDED IRON FORMATIONS

A contact zone between quartz-garnet-magnetite rock (the so-called "Banded Iron Formation") and a feldspathic garnet-biotite gneiss was examined petrographically. It has been anticipated that the contact selvages would bring forth some evidence as regards the possible origin of either rock type, or both. Specimen numbers A139/51, 52, 53 and 54 were used in this study. This suite shows a good transition from massive, finely-banded quartz-garnet-magnetite rock, through a siliceous garnet magnetite with quartzose bands, to a feldspathic gneiss with a fair percentage of magnetite and conspicuously large garnets. Banding is very fine in the B.I.F. itself, but coarsens as the gneiss proper is approached. These coarser bands are siliceous and contain practically no feldspars. A sudden increase in the feldspar content is coincident with the development of a rather homogeneous feldspathic gneiss. Magnetite has decreased markedly, although it is still capable of detection with a small Alnico hand magnet in the hand specimen of gneiss.

The essential mineralogical features of B.I.F. are the abundance of manganiferous garnet (rather more brown in colour than the usual pink almandine), magnetite, quartz and apatite. A chemical analysis, culled from the Andrews Memoir, follows.

Chemical Composition of B.I.F.

SiO ₂	31.34
Al ₂ O ₃	8.34
Fe ₂ O ₃	32.10
FeO	6.75
MgO	0.94
CaO	7.54
Na ₂ O	0.11
K ₂ O	0.05
H ₂ O+	0.52
H ₂ O-	0.36
CO ₂	0.01
TiO ₂	0.40
ZrO ₂	-
P ₂ O ₅	4.67
SO ₃	Tr.
Cl	0.09
NiO + CoO	tr.
MnO	7.08
V ₂ O ₃	0.02
<u>Total</u>	100.30
<u>Sp. Gr.</u>	3.809

The chemical composition is that of an iron-rich sediment. Several features are of significance:-

1. The high iron content, largely as Fe_2O_3 . Iron is incorporated in both magnetite (over 50% of most B.I.F. specimens) and in iron-manganese-rich garnets.
2. An abnormally high MnO content. MnO is conspicuous in many chemical analysis of Broken Hill rock types. It may be a feature the original sediments, or alternatively an element introduced during the emplacement of the main lead-zinc lode.
3. A relatively high percentage of P_2O_5 as apatite. High Cl content suggests that this is chlor-apatite.
4. A fairly high CaO content (largely as apatite, but also in garnet).

Petrogenesis of B.I.F.

W. R. Browne (1922) was of the opinion that these rocks were initially intrusive rocks, possibly as a differentiate of a gabbroic magma. He suggested that the abundance of apatite was characteristic of igneous percentage, and that flakes of muscovite present were derived from the intruded sediments. A common origin was propounded for B.I.F. and hornblende-rich amphibolites on the basis of both containing manganese-rich garnets of supposedly primary origin.

B. P. Thomson also discusses the association of the iron formations and conformable, banded amphibolites. These rocks have been found interbedded by H. F. King. Thomson believes that B.I.F. is a metamorphosed iron-manganese-lime rich sediment which has been decarbonated subsequent to deposition. The evidence stated for such an origin is that:-

1. B.I.F. is remarkably persistent along strike.
2. MnO and P_2O_5 content is fairly constant.
3. A sedimentation environment which favours the deposition of calcareous sediments is apparent from other rock associations. The prevalence of limey sediments is a feature of Broken Hill sedimentology.

Discussion & Conclusions

It is quite certain from field evidence that B.I.F. is sedimentary in origin. Although horizons of this material are rather spasmodic in distribution, they are locally continuous and always perfectly conformable with the sedimentary sequence. A patchy blanket of B.I.F. covers most of the district.

Microscopic study of contacts is suggestive of a sedimentary change in lithology. In the special case of B.I.F. changing to granitic gneiss, the contact is suggestive of a metasomatic transformation, rather than a distinct change from

iron-rich sediment to feldspathic sediment. Three phases are obvious from an examination of thin sections:

1. Very fine relic sedimentary banding due to an alteration of layers of magnetite, garnet and quartz.
2. A coarser banding in which the structure is somewhat gneissose. Biotite and a little muscovite may be present along planes of faint schistosity. Magnetite and stringers of fine-grained garnet are separated from seams of coarser quartz crystals.
3. Feldspathic gneiss in which banding is obscure and vaguely definable, due to black, aligned flakes of biotite and minor elongate segregations of magnetite.

Both rock types, B.I.F. and feldspathic gneiss, are regarded as of sedimentary origin here. The most impressive feature is the "onset of silicification" of the outer shell of B.I.F. It is suggested that during metamorphism there was a preferential migration of mobile silica into the B.I.F. with a corresponding exchange of magnetite. The B.I.F. gradually merges into feldspar-garnet gneiss by a process of enrichment of siliceous layers initially in the far-reaching quartz, and then in quartz and feldspars. Magnetite bands, now distorted and irregular, often knotted, have diffused into the body of feldspar gneiss in exchange for quartz and feldspar which enlarged and coarsened relict sedimentary bands in the B.I.F.

The chemical composition (see analyses provided) is that of an iron-rich sediment. An igneous rock of such a composition would be peculiar, to say the least. If it is accepted that these rocks were sedimentary, then an investigation of the nature of the iron-rich sediment is of interest. Iron-rich sediments may be:-

1. Bedded iron silicates: including greenalite, chamosite, glauconite, minnesotaite, and others.
2. Bedded iron oxides: hematite, limonite, magnetite.
3. Bedded iron carbonates: largely siderite.

There is no need to seek further than the iron oxides to explain all features of B.I.F. In most cases oxides and hydroxides of iron are mingled with impurities such as particles of quartz, clay minerals, calcium carbonate and oxides and hydroxides of manganese. The environment of deposition of these sediments is of such a nature that oxides and hydroxides of iron and manganese could be chemically precipitated with carbonates and phosphates of calcium in subordinate amounts.

The siliceous banding, sometimes extremely fine, but usually variable, would suggest a settling of sand grains between periods of precipitation of layers of iron oxides. This banding typifies these formations and is a characteristic relict

sedimentary feature. An interesting article appeared in "Economic Geology", Volume 50, 1955, Number 5, by Eugene A. Alexandrov. In a study of Precambrian banded iron ores he suggested that the intermittent banding of silica and iron oxides in Precambrian banded ores was caused by the selective weathering of the Precambrian soil. Due to the seasonal changes of temperature, amount of precipitation, and the alternately higher and lower pH range of the leaching solution, the Precambrian soil yielded:-

1. Silica during the warm season, and
2. Iron oxide during the cool period of the year.

The fineness of the banding of these rocks at Broken Hill does not weight against this explanation. Indeed, the banding prior to metamorphism may have been even finer. Metamorphic recrystallisation is often accompanied by a coarsening of grain size. The banding would necessarily be extremely fine if such a theory was to be entertained. Very little sediment would accumulate from season to season - hence the deposition of a finely laminated sediment.

Chemical deposition of calcium carbonate, iron minerals, manganese minerals, phosphate, evaporites and organic matter has been discussed recently by Krumbein and Garrels. They have shown the relationships between deposition of these materials and the variations of hydrogen ion concentration, pH, and redox potential, Eh, of the environment. Their classification of chemical sediments shows the relationship of "end members" to Eh and pH, and indicates the genetic relations among the chemical "end members".

The pH-Eh graph (following page) summarises the occurrences of end members within certain well-defined limiting values of Eh and Ph, characteristic of the environment of deposition. Hematite, limonite, oxides of manganese, silica and calcium phosphate occur within the field "A", and all may be precipitated from solution under these conditions. Thus the association of iron, manganese, silica and apatite in B.I.F. can be accounted for. The high percentage of alumina, originally deposited as clay minerals, must also be explained. Unfortunately the conditions of precipitation of the remarkably varied clay minerals have not been satisfactorily formulated. The presence of clays in many marine bedded iron ore deposits, however, testifies to a precipitation under similar physico-chemical conditions.

A pH-Eh control is not applicable to any form of deposition within a "swampy" or epineritic environment, where oxides or hydroxides of iron and manganese may accumulate as flocculating colloid particles. The treatment has only been applied to chemical sediments of marine origin. The association of these bedded iron ores with horizons of limey sediments, shales, arkosic quartzites and quartzites at Broken Hill strongly supports a chemical origin under marine conditions of deposition, rather than colloidal settling within a confined basin or swamp area.

Are there any advantages in postulating an origin by deposition of iron silicates or carbonates? Both alternatives have certain difficulties. The iron silicates may form thinly bedded and laminated rocks. Calcium and phosphorus contents here may be quite high, and manganese (often nodular) is a frequent associate of these sediments. However, on metamorphism, the overall silica content would be rather high, which is in conflict with analyses. These are doubtless theories which could provide a means of iron concentration and removal of silica, but the simplicity of oxide or hydroxide precipitation renders unnecessary any exploration in this direction.

The process of decarbonation must be explained if the iron compounds were deposited as carbonates. In addition, there is no evidence of any relics of calcite, siderite, etc, or, for that matter, of iron silicates. Remnants would not be expected if complete metamorphic equilibrium were established, but such is rarely the case in practice.

Thus, in conclusion, it can hardly be disputed that the B.I.F.'s were originally chemically precipitated oxides and hydroxides of iron and manganese, along with some clays, minerals, sand and lime.

2. AMPHIBOLITES CLOSE TO THE MAIN LODE.

Broken Hill amphibolites are normally coarse-grained granoblastic rocks consisting chiefly of hornblende and subordinate calcic plagioclase, with minor quartz, garnet, zoisite and magnetite. They may be more or less banded. The banded types can be seen to grade into massive, hornblende-rich amphibolite with little or no banding.

Relation of amphibolites to other rock types.

Amphibolites are related to banded iron formations in some localities. Here it is notably rich in magnetite, and constitutes a serious magnetic anomaly to be considered in any magnetic survey. At other places it is intimately associated with feldspathic gneiss, both those types resembling Potosi Gneiss and also the Hanging Wall gneisses. Many gradations have been observed where amphibolite grades through an amphibolite-rich Potosi-like material (the so-called "Potobolite") into quite good Potosi Gneiss. In addition, interpretative cross-sections north of the De Bavay fault clearly shows Hanging Wall Gneiss "B" lensing out, and amphibolite taking its place (see cross-section "AA"). These associations must have some bearing on the possible origin of the amphibolites

Petrogenesis of Amphibolites.

It would assist in elucidating the general stratigraphic sequence if clarification of the likely origin of these bedded amphibolites were possible. An explanation of cross-cutting bodies presents no difficulties. These rocks were originally igneous bodies of basaltic composition, injected into planes or openings of weakness. Regional metamorphism has had a retrogressive action on the igneous assemblage so that the mineralogical composition has changed to that of an amphibolite. Of course, this reasoning can be applied to the conformable, "bedded" amphibolites with equal success. However, the question must arise as to whether these rocks were initially sediments, locally rich in iron, calcium, magnesium and alumina, which on metamorphism have changed to amphibolite. Quite definite evidence of such a change exists in many amphibolitised areas, and may also apply to many amphibolites near the lode at Broken Hill.

From a comparative investigation of banded amphibolites of the Peak Hill - Silver Rock - Apollyon Valley areas and from the Broken Hill Basin, A. B. Edwards has concluded that the latter were not metamorphosed impure magnesian limestones. The amphibolites from Peak Hill etc. were derived from limey sediments in which MgO-rich shaley limestone bands alternated with CaO-rich bands. Subsequent regional metamorphism has produced a striking green and grey banding. However, Edwards believed that the transition from metamorphosed limestone to typical amphibolite is not borne out by petrographic examination. He invokes metasomatism to explain the transition. On the basis of fundamental differences in mineralogical composition and textures between the amphibolites of sedimentary origin, and those in the Broken Hill Basin, Edwards dismisses the concept of a sedimentary origin of the latter.

B. P. Thomson on the other hand gives a sedimentary parentage to all the amphibolites; that of mixed dolomitic, arenaceous and argillaceous sediments. The rocks have been metasomatised in conjunction with the transformation of pelitic sediments into massive metasomatic pegmatite. Considerable mobility of iron, magnesium and aluminium was implied. As evidence he cites the association of amphibolite and large masses of metasomatic pegmatite in the Corruga Anticline. Here, rocks below the granite gneiss are selectively pegmatized, and amphibolites are abundant. In contrast, the sediments between this anticline and Broken Hill were sparsely pegmatized and notably lacking in amphibolite. Impure limey quartzites and epidosite have developed instead of amphibolite. The behaviour of iron was recognised as a major difficulty. At Silver Rock, rather iron-free limestone has been locally converted to a rock consisting chiefly of iron-rich amphibole. A "basic front" hypothesis was adopted by Thomson to explain this enrichment.

Discussion

A number of rock suites were collected at Broken Hill which illustrate contacts between amphibolite and other common rock associates. It was thought that a microscopic study of these rock types, and of various stages of amphibolitisation, as apparent from transitional contact selvages, would throw some light on the possible origin. The following suites appear under "Rock Slide Descriptions":

1. Thin sections Al39/33, 34, 35 and 36 which represent a transition from "Potobolite" to coarse-grained amphibolite.
2. Thin sections Al39/59, 60, 61, 62 and 63 which show a contact between sericite schist and massive granulose amphibolite.
3. Thin sections Al39/41, 42, 43, 44, 45, 46, 47 and 48, which illustrate a gradational contact between sericite-biotite schist and rather sheared-out, foliated biotite-amphibolite.
4. Thin sections Al39/49a, 49b, and 49c; a transition from a feldspathic garnet-biotite gneiss to streaky amphibolite.

Many other thin sections were described, but because of a general similarity to the above suites, and also similarities between individual specimens, these have not been included in the section containing rock and thin section descriptions. They have been included in the "Cross-section Specimen Locations".

It is suggested that the majority of the amphibolites

in the vicinity of the main Broken Hill lode were injected igneous rocks, possibly basalts or dolerites, which have subsequently been subjected to retrogressive metamorphism. A discussion of the pros and cons influencing this opinion follow:

1. The amphibolites are lensy in form. However, this does not tell against a sedimentary origin. Sedimentary lenticularity is a common feature of sedimentary horizons in many areas. Lensing-out, due to "flow thinning" along fold limbs could also explain this feature. However, injected igneous masses are necessarily lenticular.
2. The conformable nature of many amphibolites would seem at first glance to point to a sedimentary parentage, but in most cases these bodies are associated with fissile sediments. Any injection of magma, especially a mobile, low-viscosity basic magma of basaltic composition, would show preference to planes of weakness (bedding planes) in the sediments. Thus the interbedded nature of amphibolites and metamorphosed sediments casts no real doubts on an igneous origin.
3. The chemical composition is a major factor supporting the igneous origin. Analyses are shown below:-

	1.	2.	3.	4.
SiO ₂	53.50	51.54	44.06	47.38
Al ₂ O ₃	16.10	14.69	12.61	14.63
FeO	16.20	15.97	19.42	15.71
Fe ₂ O ₃	1.60	0.17	0.35	0.66
CaO	7.50	7.92	10.75	9.60
MgO	0.90	2.89	7.20	9.07
Na ₂ O	0.50	1.16	0.17	0.64
K ₂ O	1.60	1.39	1.96	0.78
H ₂ O +	0.40	0.19	0.17	0.15
H ₂ O -	0.30	0.84	1.83	0.60
CO ₂	0.24	0.02	0.08	0.08
TiO ₂	0.49	2.00	1.39	1.40
MnO	0.95	0.70	0.52	0.15
P ₂ O ₅	-	0.75	0.34	-

Total

These figures were obtained from Andrews, p360.

1. Garnet amphibolite. Alongside caretaker's house, M.L. 38. Analyst, G.T. Pyke.
2. Garnet amphibolite. Oxide Street, midway between

Slag and Carbon Streets. Analyst, F. H. Searcy.

3. Amphibolite. Near Hanccey's house. Analyst, F. H. Searcy.
4. Amphibolite. Intersection of Block 16 and Menindie Railway. Analyst, J. Whitelaw.

These rocks are iron-rich, and unusually rich in titania (as sphene or ilmenite in the amphibolite). CaO and MgO are also rather high, with silica often less than 50%. The composition is that of a typical basalt. Often the amphibolite is nearly entirely hornblende of an iron-rich variety, with subordinate calcic plagioclase. A sedimentary rock with a bulk chemical composition from which this could be derived would be peculiar. It would consist of an iron carbonate-rich magnesian limestone, with a relatively high TiO₂ content and a low silica percentage. Advocates of a sedimentary origin must therefore turn to considerable iron, aluminium, magnesium metasomatism to explain such a composition.

4. Banding is sometimes fairly prominent in the marginal portions of amphibolite bodies. These consist of layers, often coarse and patchy, which are rarely continuous. They are alternations of crystalline hornblende on the one hand, and a rather calcic plagioclase with minor, often insignificant quartz on the other. Garnet-bearing amphibolites, abundant on the western side of the main lode (Stillwell, 1922), show a greater degree of banding, and the white layers are fairly siliceous. It was noticeable that these rocks contain correspondingly less hornblende, and the obvious inference is that hornblende has given way to garnet and silica. The slight increase in silica content as shown by chemical analyses (see analyses 1 and 2) could be explained by a minor metasomatism. Silica is a particularly mobile species, and an introduction from associated sediments during metamorphism would be quite likely. Epidote is a frequent constituent of the lighter bands or streaks, although it never reaches any great proportions. It is a low temperature derivative of the calcic plagioclase. Metamorphic differentiation can be used quite satisfactorily to explain the phenomenon of banding. Relic bedding of a sediment, considerably modified by metamorphic reorganisation of materials, is the alternative suggestion. The fact that contact selva ges show a rapid diminution in the degree of banding, such that the "amphibolitised" zone changes sharply to coarse-grained, granulose amphibolite, militates

against a sedimentary banding. More likely the bands are the result of metamorphic diffusion of ions from the adjacent rock bodies, with a corresponding movement of hornblende in the opposite direction. Association of "like" species has produced the banding.

5. The contact mineral assemblage evidence is on the whole rather inconclusive. It was apparent that in the case of adjacent feldspathic gneiss rock types, a quite gradual transition was usual. The amphibolite-proper was reached by an imperceptible increase in hornblende, accompanied by a decrease in quartz, feldspars, garnet and biotite. All intermediate stages were observed - "Potobolite", for example. Contacts with sericite schist are, however, quite sharp. Stress effects are apparent, with a development of fibrous amphibole, but, nevertheless, there has been little mobilisation of amphiboles, and banding is always poor or absent. It is suggested that the granitic gneisses contain a greater proportion of mobile components which can move freely during metamorphism, producing a gradational contact. A small-scale metasomatism is invoked, but the words "small-scale" must be emphasised. The tendency is to dilute the iron-magnesia concentration of the amphibolite by diffusion across rock contacts, rather than to concentrate it, as would be the case if a metasomatic sedimentary origin were adhered to.

6. It has been suggested by A. B. Edwards that the amphibolites are genetically related to near-by pyroxene granulites. The granulites are of igneous origin, but they exhibit a degree of banding comparable with many amphibolites. Retrograde metamorphism conceivable converted originally igneous material to pyroxene granulite - a further stage backwards would see the development of amphibolites.

Conclusion

In conclusion, it is suggested that the chemical evidence is the main factor influencing a decision in favour of igneous origins for these rocks. This is coupled with the inadequacy of the metasomatic process, which must be highly selective and at the same time involve intense concentration locally of iron, aluminium and magnesium. The existence of metasomatism is not questioned, but the nature and degree of metasomatism required here is disputed. An igneous origin explains all features of the amphibolites adequately.

3. THE SILLIMANITE GNEISSES

High grade regional metamorphism is characteristic of the Broken Hill district. This has resulted in a widespread development of sillimanite gneisses from originally argillaceous sediments. These gneisses, consisting chiefly of garnet (almandine), sillimanite, biotite, quartz and cordierite, are well known in the zone of intense dynamothermal metamorphism close to the main lode, but are by no means restricted to the lode area. Surveys (Central Geological Survey and Enterprise Exploration) have revealed a wide distribution over the entire district.

Field observation, along with petrographic and chemical studies, all support a sedimentary origin for these rocks. Bands of gneiss are not continuous laterally, but this does not detract from a sedimentary origin. Sediments are frequently lensey, and undergo continual facies changes along strike in some localities, these features being dependent on the environment of deposition. The original shaley material is often thinly bedded and intercalated with sandy and arkosic layers which testify to a sedimentary sequence. A gradation in the size of garnets as a quartzite contact was approached was noted by Gustafson. This can be explained by a change in the bulk chemical composition of layers of shaley sediments being deposited, as the conditions of deposition varied. In addition, original bedding planes have often been preserved.

About half a dozen thin sections of typical garnet-sillimanite gneiss and biotite-sillimanite gneiss were examined microscopically, and many other gradational types (richer in feldspars etc.) were studied in an investigation of the petrogenesis of the Potosi-like gneisses. Sillimanite gneisses are often associated with Potosi Gneiss, and appear to grade into the latter by a steady soakage in feldspars.

Included under "Rock Slide Descriptions" are A139/20 and A139/100, both as "end members" of suites illustrating transitions from Potosi Gneiss to garnet-sillimanite gneiss and sillimanite-biotite gneiss respectively. Slides A139/65 and 66 are also good examples of sillimanite gneiss. Specimens A139/71, 72, 73 and 74 are intermediate members of a suite showing a change from sillimanite gneiss to sericite schist. However, 71, and 74 are not really typical of sillimanite gneiss and sericite schist, respectively. Specimens A139/20 and A139/41 are required as "end members" of the suite. Other suites and individual specimens, of which slides were cut, are included under "Cross-section Specimen Locations".

The mineralogy and textures are typical of a highly metamorphosed argillite. The mineral assemblage is garnet-cordierite-sillimanite-biotite, with sillimanite and biotite always abundant, but garnet and cordierite extremely variable. Quartz and feldspar

contents are relatively low in most cases. These rocks have been classified by F. J. Turner as:-

Facies: Amphibolite.
sub-Facies : Sillimanite-almandine.

Of minor interest is the presence of small stumpy zircons, similar to those found in the granitic gneisses.

Chemical analyses of several sillimanite gneisses appear on the following page. The composition is that of a typical shaley sediment, high in alumina and silica, and containing a relatively low calcium and sodium content. Ferrous iron is dominant over ferric iron. Iron is incorporated in almandine garnet, and in biotite. The relatively high MgO/FeO ratio could explain the presence of cordierite in some assemblages, although the occurrence of this mineral is rather spasmodic. The rock is deficient in potash feldspars, but is often locally sericitised so that the K₂O content may be abnormally high because of introduced potash. The average K₂O content is 4%, and potassium occurs mainly in biotite, which is iron-rich and fairly abundant in most of the gneisses. MnO is rather low, and manganese is apparently confined to garnet. The high alumina content, a feature of this rock, is due to the predominance of sillimanite, biotite and garnet, all of which incorporate alumina in their structures to some extent.

The sillimanite gneisses are of some importance in later discussions on sericitisation and petrogenesis of the "pseudo-Potosi Gneisses" and Hanging Wall Gneisses.

Chemical Analyses of Sillimanite Gneisses

	1.	2.	3.	4.
SiO ₂	59.76	62.56	53.36	54.02
Al ₂ O ₃	20.08	19.41	25.36	27.24
Fe ₂ O ₃	2.20	0.7	0.7	1.45
FeO	7.38	7.20	7.83	7.56
MgO	2.32	2.12	2.11	2.13
CaO	0.40	2.22	1.22	0.62
Na ₂ O	0.49	1.86	0.76	0.60
K ₂ O	3.76	2.41	4.75	4.21
H ₂ O +	1.55	0.09	0.44	0.22
H ₂ O -	0.27	0.61	1.81	0.95
CO ₂	0.01	0.02	0.05	0.06
TiO ₂	1.05	0.72	1.20	1.52
P ₂ O ₅	0.19	0.07	0.14	-
MnO	0.18	0.29	0.20	0.20
Cl	Tr.	-	0.04	-
SO ₃	nil	-	0.02	-
BaO	0.19	0.09	0.09	nil
<u>Total</u>	100.29	100.37	100.16	100.46
<u>Sp. Gr.</u>	2.903	2.903	2.904	2.89

Locations and Sources.

1. Andrews, p 299. Sillimanite gneiss from north-west side of Round Hill. Analyst, H. P. White.
2. Andrews, p367. From cutting on Menindie Railway east of Block 14. Analyst, J. C. H. Mingaye, Mines Dept.
3. Mawson, p 284. 200' level, Rupee Mine. Analyst J. C. H. Mingaye.
4. Andrews, p 367. Near dam, North Mine. Analysts, P. W. Moncrieff, W. Usher, Zinc Corp. Ltd.

4. SERICITE SCHISTS.

Garnet-sillimanite gneisses in the immediate vicinity of Broken Hill have been extensively sericitised, this sericitisation having been achieved by a metasomatic addition of potash and much water to the sillimanite gneiss. It has not been confined within a specific horizon, but occurs in many bodies of sillimanite gneiss, apparently in the zones of greatest rock flowage. This sericite schist development is rather different from the metasomatic alteration of orthoclase, plagioclase, garnet, etc., close to the main lode channel. Here, the feldspars, particularly orthoclase, have changed to an aggregate of extremely fine-grained sericite, randomly oriented within remnant mineral grains. Blue-grey quartz, a mineral characteristic of the lode horizon itself, has been introduced also, often on a large scale. There has been little shearing stress acting on these rocks, with no subsequent impartation of a coarsely-crystalline schistosity. Alkaline fluids have brought about sericitisation by a gentle permeation and retrogressive transformation.

Sericite schists away from the lode are distinctly schistose, with large flakes of sericite and subordinate biotite exhibiting a strong preferred orientation. Quartz grains often show signs of strain, and have recrystallised under stress, with marked elongation in the plane of schistosity. One problem is whether or not this sericitisation should be linked with lode formation and lode sericitisation (as apparent from close-in wall rock alteration, and somewhat weaker, farther-reaching effects). Traces of lead, zinc and iron sulphides, gahnite and galena, are apparent in these rocks, but this is a feature of nearly all rocks at Broken Hill, even those on which metasomatism has been almost negligible. (e.g. B.I.F.). Lode metasomatism in many cases has not involved the addition of much mobile potash, although water, in large quantities, is essential. In the majority of cases it is the potassium-bearing minerals which have been altered, with a partial alteration of plagioclase and garnet (often insignificant). It is suggested that the introduction of Potash near the lode was accomplished by extremely dilute solutions, and that much of the metasome (K^+ ions) may have been extracted from decomposing potash-bearing minerals.

Maximum development of sericite schist is most apparent where sillimanite gneisses predominate; there has been an obvious change from sillimanite gneiss to sericite schist. The nature of the change is of prime importance. Retrograde metamorphism generally involves the formation of minerals more hydrous than those preceding. Thus here, sillimanite has changed to sericite. This alteration has been complete in nearly all specimens of sericite schist examined, but relict sillimanite, engulfed in a mass of fine-grained sericite, has been observed.

Chemical analyses (next page) reveal a considerable difference, often 3% to 4%, in H_2O+ for sericite schist and garnet-sillimanite gneiss. Water may, or may not, be introduced from an outside source in such a case. It is always possible to postulate that the water may have been locally accumulated in the original shaley rocks. The mineral assemblages may have retained equilibrium with a dense hydrous vapour at the stage of maximum intensity of metamorphism, but during the subsequent decline in temperature hydration may have been affected. Thus, if the system had been a closed one, sericitisation would have been an integral part of the regional metamorphism. However, the analyses also require an increase in potash of several percent, which suggests that the system was open and that both water and potash (possibly as a soluble potassium silicate) were introduced. It is unlikely that the higher K_2O content of the sericite schists is a peculiarity of the original sedimentary formations. Distribution of sericite schist is not controlled by original sedimentary features, such as a lenticular change in facies.

The association of sericitisation with zones of rock flowage substantiates the hypothesis of an open system. Internal deformation is the main factor in the sericitisation of this area. Stress alone cannot bring about sericitisation, but it acts indirectly, opening rock pores and providing channels of easy access. These channels are, more explicitly, planes of weak cohesion and discontinuity which may be a function of original bedding, flow cleavage, fracture cleavage, or an earlier schistosity. Chemically active fluids may then cause sericitisation by movement through the deformed rock, permeating along, and spreading out across these planes. Growth of platy micas, both sericite and biotite, would be expected along and parallel to the planes of permeation; hence the retention of a fine schistose structure, characteristic of the pre-formed sillimanite gneisses and schists.

It is significant that the zones of maximum sericitisation are confined to areas of intense deformation by "plastic flow folding". Thus on the western side of the main line of lode, where complex folding predominates over faulting, sericite development is very extensive. To the east, where rocks of a highly competent nature have yielded more by fracturing, sericitisation has been confined to quite thin zones. This distribution can be seen more clearly from the plan and interpretative cross-section of the DeBavay area on the following page. Stress relief by fracturing on the eastern side of the lode has required no great internal readjustment in the beds, but on the west, for the beds to conform to the fold shapes shown without fracture, intense rock flowage with metamorphic

recrystallisation is required along planes determined by stress conditions. It is suggested that sericitisation was accomplished during this upheaval by an introduction of alkaline (potash-rich) fluids from an external source, possibly magmatic. Rock flowage favours the incompetent beds, i.e. shale or derived garnet-sillimanite gneisses, and sericitisation is therefore more apparent in these beds.

The "granitic gneisses" have also suffered a widespread but less intense sericitisation. Here the mica is extremely fine-grained, and occurs as long streaks or elongate pockets, intimately associated with biotite within the foliated layers of the gneisses. Streaks of sericite invariably parallel the planes of schistosity. The directed growth is suggestive of a structural control of the metasomes, and the fine-grained nature and randomly-oriented distribution of sericite on the shear planes shows that no movement has taken place since their growth. Thus sericitisation occurred after the main folding which had caused the gneissose and schistose structures to develop in the rocks.

In conclusion, the following points are worthy of note:

1. Sericitisation here is a metasomatic change of retrograde effect.
2. It is not an integral part of the regional metamorphism.
3. It is controlled by structural deformation and can occur to some degree in all rock types providing localised stress relief has opened zones of access to the metasomes.
4. Rock folding has not been locally complicated because of "flow" areas of pre-folding sericite schist. Sericitisation followed the complex folding.
5. There is no real evidence that the sericitisation of rocks away from the main lode is in any way connected with lode emplacement.

Chemical Analyses of SericiteSchists and Garnet-sillimanite Gneiss

	1.	2.	3.	4.
SiO ₂	59.18	56.63	67.17	58.88
Al ₂ O ₃	24.02	22.25	16.78	21.83
Fe ₂ O ₃	0.50	0.57	0.89	4.60
FeO	6.26	6.87	5.40	2.25
MgO	1.67	1.54	0.43	1.03
CaO	0.56	0.65	0.61	0.54
Na ₂ O	1.07	0.24	0.56	0.66
K ₂ O	4.83	6.84	2.92	5.94
H ₂ O +	0.14	2.16	1.48	3.42
H ₂ O-	1.01	0.21	0.08	0.16
CO ₂	0.05	nil	Tr.	0.01
TiO ₂	0.88	0.93	0.88	0.52
P ₂ O ₅	-	0.17	-	0.18
MnO	0.08	0.71	2.73	0.03
SO ₃		0.59	0.02	
BaO		0.14		0.11
Cl			0.02	
F			0.13	
<u>Totals.</u>	100.25	100.50	100.04	100.16

1. Sillimanite gneiss. Main cross cut, 1550' level, North Mine. Andrews, p367. A typical sillimanite gneiss.
2. Garnet-sericite schist, with remnants of sillimanite. 1370' level, South Mine. Analysts, Avery and Anderson. Water content is lower because of partial sericitisation.
3. Garnet-quartz-sericite schist. Footwall, King shaft orebody in British Fault, Junction Mine. Analyst, G.C. Carlos. Quartz layers cause the high SiO₂ content. H₂O+ is still high.
4. Sericite schist derived from sillimanite gneiss. Fox Basin, Andrews, p 302. The high water content is of interest.

5. THE PLAGIOCLASE "QUARTZITES"

Intercalated with fine bands of sillimanite gneiss are thin psammitic bands of recrystallised quartzo-feldspathic sediments known as "quartzites". These rocks are obviously sedimentary, but are unusual in that soda content is higher than potash, and CaO higher than MgO. This leads to an abundance of calcic plagioclase, with very little orthoclase or microcline. The "quartzites" consist chiefly of granoblastic quartz, plagioclase and subordinate pink almandine garnet, with traces of brown biotite. Chemical analyses of typical Broken Hill "quartzites" are shown on the following page.

A detailed study of these rocks was not made, but a discussion is of some value in as much as their origin seems to be analogous to many other feldspar-rich granitic gneisses, granulites and "aplites" in this district.

W. R. Browne.

W. R. Browne suggested that most of these plagioclase-rich "quartzites" were in fact altered (severely metamorphosed) igneous rocks. He believed that abundance of plagioclase, especially that of andesite-bytownite composition, was foreign to a sedimentary rock.

F. L. Stillwell

Stillwell, on the basis of:-

1. granoblastic texture.
2. detrital quartz grain outlines.
3. rounded zircons.

gave these rocks a sedimentary origin. It was considered that plagioclase could be developed if the necessary lime was present. Stillwell suggested a definite relationship between granulites (granoblastic plagioclase quartzites with pegmatitic veining) and Potosi Gneiss. The quartz-orthoclase-plagioclase veins were attributed to "metamorphic differentiation".

B. P. Thomson

Thomson agrees with Stillwell. He states that the abundance of plagioclase is no difficulty, but accords with recent views on sedimentation and diagenesis. He presents further evidence of sedimentary character in the presence of graded bedding, visible in thin section of plagioclase quartzite. Also a resemblance to graded bedding occurs megascopically in fine-grained sandy beds, interbedded with sillimanite gneiss.

Chemical Composition of "Quartzites".

SiO ₂	76.98	86.60	86.40
Al ₂ O ₃	11.01	5.85	7.20
FeO	4.54	2.96	3.02
Fe ₂ O ₃	0.26	0.07	0.64
CaO	2.38	2.00	0.76
MgO	0.61	0.15	0.13
Na ₂ O	0.41	0.66	0.45
K ₂ O	1.95	0.82	0.84
H ₂ O +	0.11	0.20	0.10
H ₂ O -	0.64	0.22	0.65
CO ₂	0.05	-	-
TiO ₂	0.75	0.20	0.20
P ₂ O ₅	-	-	-
MnO	0.22	0.19	0.13
BaO	-	-	-
SO ₃	-	-	-
<u>Total</u>	99.89	99.92	100.52
<u>Sp. Gr.</u>	2.78	2.70	2.69

1. "Quartzite". Open Cut, South Mine. Analysts, W. Usher, P. Moncrieff, Zinc Corp.
2. "Quartzite". M. L. 38, Central Extent, near Caretaker's house. Analyst, J. Whitelaw.
3. "Quartzite". Quarry, Block 14. Analyst, J. Whitelaw.

Discussion

The main evidence for a sedimentary origin lies in the nature and form of the rock bodies. The following features can act as a summary:-

1. Thin bands of "quartzite", laterally continuous, are interbedded, with other sediments (e.g. sillimanite gneisses, etc), and often show pronounced alteration from "quartzite" to gneiss to "quartzite", and so on.
2. Evidence of graded bedding (Thomson). This is a matter of petrological interpretation, however.
3. Contacts between "quartzites" and other rock associates are sometimes quite sharp, especially when the rocks are thinly bedded. Diffusion of materials during metamorphism has blurred many of these, however.

Most geologists now accept the sedimentary origin. The degree of metasomatism, however, is likely to be controversial. One can accept the high CaO and Na₂O contents as original calcium and sodium, or it is possible to introduce these ions into the "quartzite". Much metasomatism has occurred near the lode, with introduction of vast quantities of blue quartz and minor gahnite etc. into many rock types. Stillwell has described "metasomatic quartzites" close to the lode. However, the "lime metasomatism" which would be required must be highly selective so that thin sheets of "quartzite" have retained a uniform composition after metasomatism. It is more convenient to regard the original sediment as being lime-rich. The metamorphism of a sub-greywacke would produce these quartzites. The occurrence of a small proportion of plagioclase feldspar is no difficulty, and the chemical composition is sufficiently high in iron, alumina and potash to account for the formation of garnet, biotite and minor sillimanite on metamorphism.

Petrographic evidence is not conclusive, but from the mineralogical aspect two features are noteworthy:-

1. The occurrence of sillimanite, which is rare in igneous rocks.
2. Abundance of rounded zircons which characterise sediments and metasediments.

Textural evidence is useless. A granoblastic texture would result from the metamorphism of both igneous and sedimentary rocks. This also applies to metasomatic derivatives.

Conclusion

Thus the position is that all evidence field, microscopic and chemical, strongly suggests a sedimentary origin. The original sediment may have been modified by calcic and sodic feldspathisation

during metamorphism. However, this may not be entirely necessary for the attainment of the present bulk chemical composition.

6. THE ORIGIN OF THE POTOSI GNEISSES

This rock type has been described in some detail in foregoing sections. As Thomson has pointed out, the high CaO content (sometimes 5%) is the main factor in the mineralogical difference between this rock and the garnet-sillimanite gneisses with which it is often closely associated. Both in the field and at underground exposures it can be seen to grade into sillimanite gneiss. It has been suggested that the Potosi Gneiss was the result of sporadic pegmatization of the sillimanite gneisses. This is supported by the lense nature of Potosi Gneiss within horizons of sillimanite gneiss, but has found no closer support. However, evidence in favour of a metasomatic origin has recently been disclosed by detailed mapping of Kintore and South shaft cross-cuts. Potosi Gneiss "B" in this case lenses out at various points, but its place is taken by a massive pegmatite, sometimes with a development of several feet of Potosi-like material at its contacts. This Potosi-like gneiss is undoubtedly metasomatic, but there is no implication as to a specific metasomatism of garnet-sillimanite gneiss. An intercalated lens of "quartzite" may have suffered this pegmatization.

Of some importance in deducing an origin is the occurrence of the so-called "pseudo-Potosi Gneisses", described in a previous section. These rocks undoubtedly occupy separate stratigraphic or structural positions. They are lense and perfectly conformable with enclosing sillimanite gneisses and metaquartzites. Curiously, though, their textural and mineralogical characteristics are remarkably uniform within the one horizon. This suggests that these bodies are local variants of the argillites which now appear as sillimanite gneiss. They may have been argillaceous sandy lenses deposited at the same time or during periods of non-deposition of the purer argillites. This is the best explanation of the apparent similarities between pseudo-Potosi Gneisses at different stratigraphic levels, and the consistency of mineralogical composition within any one body. A selective metasomatism of a favourable bed would also explain the lense and conformable form adequately, but would it have equal success with the problem of uniformity of mineralogy and textures? One might answer in the affirmative if these rocks were only of local extent, but these lenses are widely distributed. A consistent metasomatism in a favourable horizon extending over several miles must be invoked.

Chemical analyses of Potosi Gneiss are shown on the following page. These resemble sillimanite gneiss closely, apart from CaO content. A chemical study of these rocks cannot prove

conclusively whether the rock was originally igneous or sedimentary. Both have difficulties, but it must be emphasised that sediments do occur with this composition, so that the analyses do not weigh against a sedimentary origin.

A microscopic study of gradational contacts and individual rock types was of little value. Findings have been summarised for the suite Al39/100, 101, 102, 103 and 104 in "Rock Slide Descriptions".

The suite Al39/15, 16, 17, 18, 19, and 20 has also been included. Both show a steady transition from granoblastic garnet-plagioclase granulite (Potosi Gneiss "C") to sillimanite gneiss. Al39/104 is a garnet-sillimanite gneiss; Al39/20 a biotite-sillimanite gneiss. The transitional contacts can be explained in several ways:-

1. By a gradual metasomatism of sillimanite gneiss with an eventual "end point" of Potosi Gneiss. Most of the sillimanite has changed to feldspars and garnets have recrystallised. Quartz content has increased either by introduction of quartz or by release during metasomatism. This process necessitates the introduction of alkalis, principally lime.
2. A similar metasomatism of another rock type - possibly "quartzite". The mineralogical phase changes in this case would not be of such a radical nature as those involved in 1. The composition again needs modification by increase in lime, but iron introduction is also necessary to account for an increase in biotite and garnet. Mineralogical phase relationships may be of importance here. It is well known that granitic magmas can make over rocks of similar mineralogical composition faster than those of dissimilar mineralogy. The same may apply to metasomatic fluids. Quartzites, possibly initially feldspathic, would need little modification to become Potosi Gneiss. However, the time factor may not be of any great importance, in which case 2. has no real advantage over 1.
3. A diffusion of mobile silic elements across a former sharp sedimentary contact as a result of a marked chemical gradient. This implies that Potosi Gneiss was initially a feldspathic sediment, and has attained its present condition without introduction or removal of material. The blurring of contacts was the result of a restricted interchange of constituents made possible by the thermal energy generated during regional metamorphism. This amounts to metamorphic diffusion, a process indicative of some considerable degree of mobility.

Stillwell in 1922 commented on the existence of ptygmatic folding within the Potosi-Footwall Gneiss. He invoked "metamorphic differentiation" as the process whereby these contorted veins were formed. Again, here is evidence of diffusion of material. To my mind this all suggests that the rocks were particularly amenable to soakage by granitising or feldspathising fluids. The internal movement of material could easily be supplemented by an introduction of metasomes from an outside source.

It was thought that minor accessory minerals such as zircons and apatite might be of some aid in determining the origin. Morphological variations of zircon grains have been used successfully in the determination of rock origins. This is in agreement with the findings of Poldervaart (1950), Slavic (1952) and Wyatt (1953). Primary igneous bodies such as pegmatites and orthogranites are characterised by euhedral, elongated zircons, with sharply terminated pyramids. Well-rounded, stumpy zircons are suggestive of detrital grains in sediments. Metasediments are characterised by rounded, moderately elongated zircons. Care was taken to observe the shape, size and abundance of zircon in these suites of sillimanite gneiss and Potosi Gneiss. The shapes are identical; slightly elongated but always rounded. However, zircon is more abundant in Potosi Gneiss, and quite rare in the sillimanite gneisses. The conclusion to be drawn is that both types were originally sedimentary. This does not necessarily influence the question of degree of metasomatism, however. Recrystallisation of zircon would not occur during such induration. The relative abundance of zircon in the two rocks suggests that the recrystallised and metasomatised sediment now seen as Potosi Gneiss was not a sillimanite gneiss originally. If the initial sediment was feldspathic then zircon would be expected to occur more abundantly. Zircons are common accessories of granitic-type rocks - the source rocks of arkoses and suchlike. Shaley rocks contain a much smaller proportion of zircon. This is slim evidence, however.

In conclusion it is possible to propound two alternative origins:-

1. A "dry transformation" of argillaceous arkosic sediments to Potosi Gneiss by high grade regional metamorphism.
2. Metasomatism of a favourable sedimentary horizon (probably sillimanite gneiss or plagioclase "quartzite") by alkali metasomes moving along bedding planes, schistosity planes, etc).

I believe that metasomatism is always a distinct possibility where fluid mobility has been shown to occur. A "smudging" of rock contacts and definite proof of exchange of mineral matter across these

contacts is evidence that some ions have been particularly mobile. The underground evidence, cited earlier, of metasomatic pegmatite grading into Potosi Gneiss at its contacts is irrefutable. However, the degree of metasomatism, the nature of the bed metasomatised, and the properties of the metasomatic fluids are open to grave doubts. I can provide no answer to any of these questions.

Chemical composition of Potosi Gneiss

	1.	2.
SiO ₂	58.22	66.38
Al ₂ O ₃	19.02	16.60
FeO	5.85	5.27
Fe ₂ O ₃	2.90	1.43
CaO	5.04	5.00
MgO	1.58	0.64
Na ₂ O	2.95	0.91
K ₂ O	1.91	1.23
H ₂ O +	0.19	0.55
H ₂ O -	0.93	0.65
CO ₂	..	0.10
TiO ₂	0.92	0.53
P ₂ O ₅	0.10	..
MnO	0.28	0.50
BaO
<u>Total</u>	99.96	99.79
<u>Sp. Gr.</u>	2.81	2.77

1. "Footwall" Gneiss. Zinc Corporation. Analyst, J. C. Mingaye, Mines Dept.
2. "Footwall" Gneiss. Near Assay Office, Zinc Corporation. Analyst, A. Kuchn, Prop. Mine.

7. THE ORIGIN OF THE HANGING WALL GNEISS

These rocks have been described in considerable detail in earlier sections. Their origins are open to much speculation, and present evidence is inconclusive. It is intended to review the possible origins of these rock types in the following pages.

Stillwell and Browne considered them to be igneous in origin.

Browne's Evidence

He regarded the Hanging Wall Gneiss, "Augen" and "Platy" gneisses as phases in the crystallisation of one original igneous magma. These gneisses, especially "Augen" and "Platy" gneiss, are similar as regards mineralogy, but differ texturally. The evidence for an igneous origin is:-

1. They are primary gneisses in which a parallel structure developed during consolidation under unequal pressure.
2. The "Augen" are true phenocrysts, often transgressing the gneissic foliation.
3. Xenoliths of invaded formations are present.
e.g. relics of sillimanite from the garnet, sillimanite gneisses.
4. Relatively basic phases are known.
5. Isolated outcrops reveal a lenticularity suggestive of a sill-like intrusion.
6. The chemical composition is that of a typical granite.
7. There is an undeniable affinity with cordierite aplite (chemical analyses) which was derived from the same magma.

Stillwell's Evidence

Stillwell considered that these rocks represent a metamorphosed granodiorite. The porphyroblasts of orthoclase were thought to be metamorphic growths rather than true phenocrysts. Metamorphic differentiation was invoked to explain the variable content of Na_2O and K_2O . Stillwell believed that chemical, microscopic and field observations supported an igneous origin, but he considered that much metasomatism of alkalis had occurred at some stage during the metamorphism. The important advance was the recognition of metamorphic textures and structures, however.

Thomson (1956).

B. P. Thomson believes that there is no real evidence for an igneous origin in the chemical composition. He suggests a

complete series of gradational changes from quartzite to Potosi Gneiss or granite gneiss. The banding in these rocks was supposedly a relict sedimentary characteristic. Points brought out from a short microscopic examination were:-

1. Rounded detrital zircons.
2. Traces of sillimanite deep in the Hanging Wall basin, hence not due to marginal contamination.
3. Relict bedding, conformable and undisturbed.
4. Quartz porphyroblasts with inclusions which supposedly show original quartz grain outlines.

Thomson believes that the granite gneiss is simply a recrystallised sandy feldspathic sediment, possibly intermediate between arkose and sub-graywacke. The conformable nature of the gneiss, certified by field mapping and diamond drilling, is good evidence in favour of a sedimentary origin.

Discussion

If the gneiss was a sediment originally, then what was the nature of the transformation from sediment to granite gneiss? Three possibilities are immediately apparent:-

1. Recrystallisation of an arkosic sediment with little or no introduction of material.
2. Recrystallisation, but with considerable metasomatism and diffusion of material.
3. Granitisation of some other sediment with pronounced metasomatism.

The highly selective nature of the metasomatism required, together with the tremendous scale for such a process, led Thomson to reject the metasomatic origin hypothesis.

From a study of two rock types ("granite gneisses") which occupy two distinct stratigraphic positions it was possible to record the following features:-

1. Traces of sillimanite are characteristic of Hanging Wall Gneiss "B" and occasionally present in "A". This is suggestive of a sedimentary origin, although sillimanite has been known to occur in pegmatite and aplite bodies, and more rarely in granites.
2. Garnet (almandine) is a common constituent of these gneisses. Again, this mineral does occur in pegmatites and granitic rocks, but rarely in the proportions found in the Broken

Hill gneisses.

3. Accessory zircons, rounded and stumpy, are ubiquitous. The shape strongly suggests a sedimentary detrital origin.
4. Occasional outlines of quartz are suggestive of relict, worn sedimentary grains. These grains are often present as inclusions within larger quartz or garnet crystalloblasts.
5. Plagioclase xenoblasts are never zoned. Zoning is typical of the plagioclase of many igneous rocks, but is rare in the metamorphics.
6. The textures of the matrix are granoblastic, indicative of a regional metamorphism - quartz and feldspar often form mosaics. A preferred structure is pronounced, parallel to the prevailing structure in the schistose or gneissic surroundings. Thus the regional metamorphism has affected the granite gneisses in the same manner as other rock units.
7. Contacts between the granite gneisses and other adjacent rocks are gradational. There is no evidence of any palimpsest contact minerals which would have developed if the gneiss had been emplaced as a sill of granitic magma. An examination of the contact suites shows that the transitions are very gentle, the sillimanite gneiss, B.I.F. etc. changing imperceptibly to granite gneiss by a gradual increase in feldspars and quartz and a decrease in sillimanite or magnetite, respectively. Metasomatism must be invoked to explain these gradations.
8. Xenoliths have not been described within the granite gneisses. The sillimanite "inclusions" mentioned by Browne are not remnants; they are essential units in the mineralogical composition of the gneiss, and are not restricted to, or near, contact zones.
9. The uniformity of composition and texture is of little aid in determining the origin of these rocks. No hard-and-fast rules apply such that a sedimentary horizon could be distinguished from a metasomatic permeation body or a sheet-like granite emplacement mass on this basis. Local variations would be expected in each case. The lateral variations described by Thomson and attributed to sedimentary facies changes can be explained equally well by a change in the degree of metasomatism.

I believe that the conformable nature of the granite gneisses over a wide area casts serious doubts on any magmatic origin. A sheet-like injection sill of granite is not feasible. Contact evidence must be inconclusive because a reworking of all rocks during regional metamorphism may have destroyed any contact minerals. No remnants of likely contact minerals were seen in any thin sections.

The gradational nature of contacts favours a metasomatic exchange, but the degree of metasomatism is indeterminate. Further evidence of metasomatism is provided by the existence of minor veinlets of enriched silica and feldspar, attributable to metamorphic diffusion. This implies a migration of pore fluids.

The occurrence of garnet and sillimanite in the granite gneiss does not detract from a metasomatic origin. Thus Sederholm finds garnet to arise chiefly in rocks in solvents or those influenced by granitic juices. Williams (1934) has likewise described pegmatites rich in sillimanite. He suggests that the conditions of formation of this mineral are pneumatolytic, and not stress. Janet Watson (1948) has also demonstrated that sillimanite can occur as a metasomatic product of granitisation.

The morphology of zircon grains was discussed in the section on Potosi Gneiss. It will suffice to say that the rounded nature of all zircons strongly supports a sedimentary parentage, but does not weigh against a metasomatic origin. A selective soaking of a favourable horizon by granitising fluids would not require a recrystallisation of these tiny zircons. Temperatures far above those of regional metamorphism and granitisation would be required to do this.

The chemical composition of the granite gneisses approximates to that of a granodiorite. Limey plagioclase is very abundant in association with orthoclase, but microcline is rare to absent. The dominance of CaO is not characteristic of arkoses. The more calcic feldspars tend to weather and break down more readily than do the alkalic species. Thus CaO would of necessity be incorporated in some mineral other than feldspar in the original sediment. The arkosic rock unit would have to be retained to account for the presence of orthoclase and quartz in such quantities as are found in this gneiss. A composition approaching that of sub-graywacke will eventually be arrived at when iron and alumina contents are considered. However, the CaO content must remain a difficulty. In this regard a metasomatism would be a useful postulate. H. H. Read is of the opinion that calcium ion metasomatism is most pronounced within the field of regional metamorphism as exemplified by widespread occurrence of sillimanite gneisses. Soda-potash migration is not restricted to lower grades, however, but the salient feature is the increase in calcium as the higher grades are approached.

The widespread regional distribution of granitic type rocks leaves no doubts as to the initial source of granitising fluids. This is particularly true of the area north of the city of Broken Hill - an area consisting largely of coarse-grained pegmatite, aplite and granite, gneissic and coarse-grained.

There is no doubt that extensive metasomatism and inhibition has occurred throughout the Willyama Series, and this does not exclude those rocks close to the lode. As Thomson has stated, the main objections to a metasomatic origin are:-

1. Selective metasomatism.
2. Large Scale replacement.

There is ample evidence in many metamorphic provinces of both of these "difficulties" occurring. Just as ore deposition has been undoubtedly controlled in many cases by replacement along a favourable bed, granitisation by wet diffusion is similarly restricted. Admittedly it would be hard to conceive a complete restriction of these fluids to the favourable horizon, and such is not the case; the granite gneisses merge into adjacent rock horizons very gradually, across contacts. Migmatization is commonly intense within pelitic rocks, but extreme rocks such as epidiorites, limestones and quartzites seem to resist this process. Thus mobilisation may be highly selective in a region consisting chiefly of alterations of these rocks.

The scale of metasomatism is as yet an unknown factor. I am quite satisfied that in this instance the relative flow of materials would be in no way more extensive than that which has caused the sericitisation of wide zones of sillimanite gneiss close to the main lode. The tremendous accumulation of granitic material in the district overall, including emplacements further afield from the city of Broken Hill, is suggestive of the existence at some stage of great quantities of active late-phase fluids, capable of granitisation.

Conclusion

In conclusion, it is suggested that the key to the problem lies in future field observations. Petrological and chemical studies have proven inconclusive, and the present field evidence is still conflicting. The whole concept of metasomatism and granitisation is in a state of perpetual controversy at present, and until ideas in theory have been tested and made factual there will be little grounds for certainty in formulating a petrogenesis for these rock types.

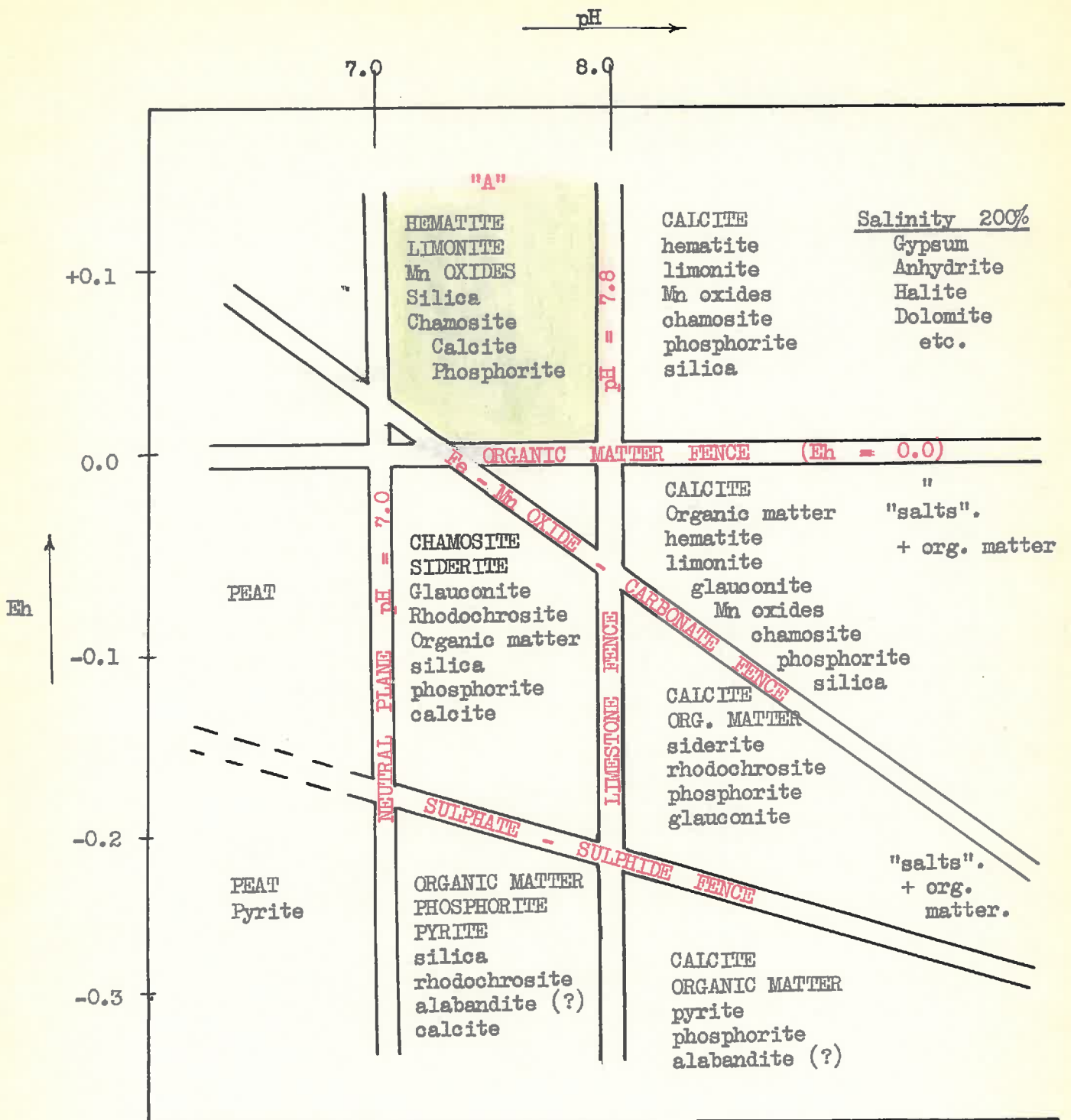
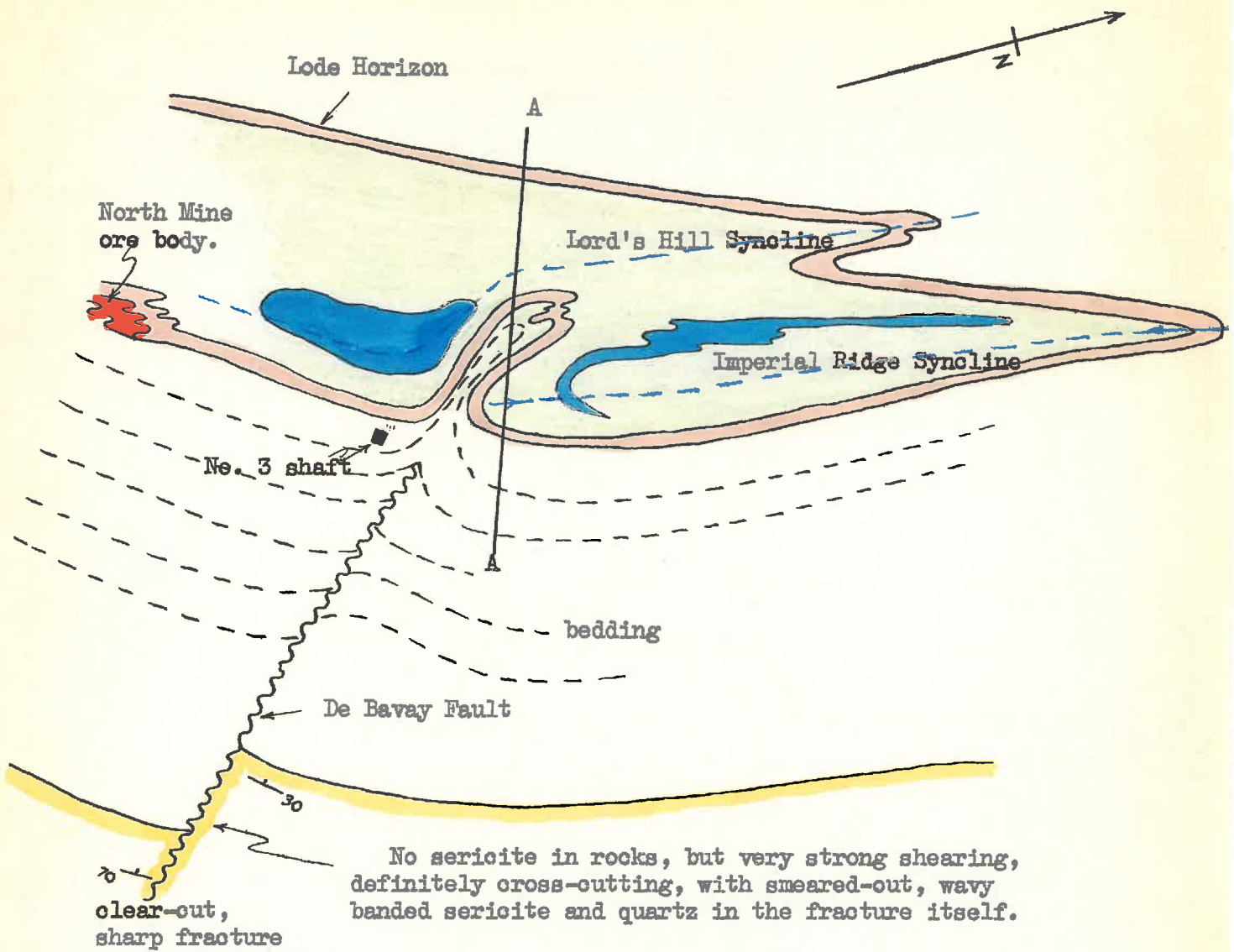

FIGURE 12.

Table from "Origin and Classification of Chemical Sediments in terms of pH and oxidation-reduction potentials", by W. C. Krumbein and R. M. Garrels. The conditions favouring deposition of the ferruginous sediments are those in field "A".



- Main lode horizon
- Hanging Wall Gneiss "A"
- Hanging Wall Gneiss "B"
- Maximum sericitization.

DIAGRAMMATIC SURFACE PLAN

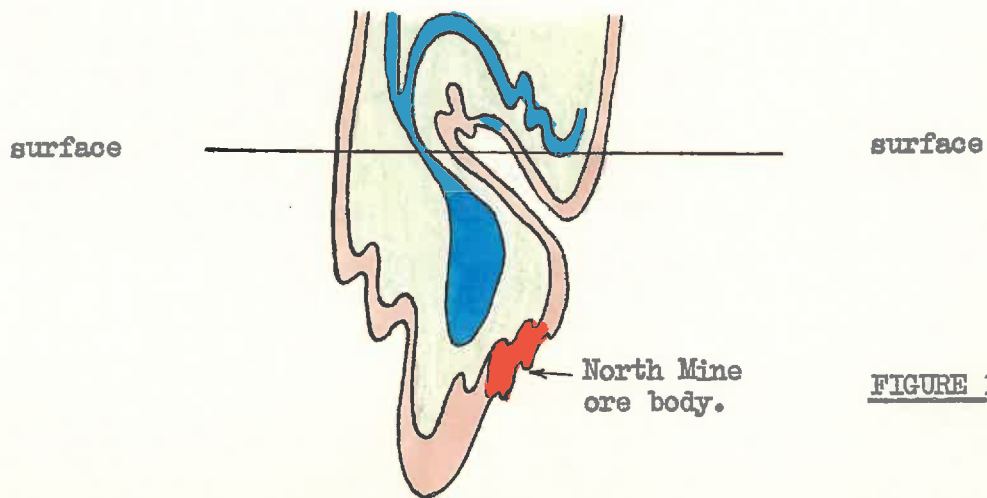

CROSS-SECTION "AA".

Chemical Composition of "Granite Gneisses".

	1.	2.	3.	4.
SiO ₂	71.10	68.64	69.30	68.13
Al ₂ O ₃	13.88	18.66	14.40	15.99
FeO	3.68	2.73	4.35	4.42
Fe ₂ O ₃	2.01	1.53	2.84	0.18
CaO	2.83	1.86	3.28	4.88
MgO	2.18	1.05	2.00	0.43
Na ₂ O	1.74	2.68	1.14	0.67
K ₂ O	1.24	1.47	0.84	4.56
H ₂ O	0.10	0.10	0.15	0.11
H ₂ O	0.45	0.35	0.60	0.50
CO ₂	0.14	0.02	0.13	0.02
MnO	0.28	0.14	0.17	0.23
TiO ₂	0.46	0.68	0.80	0.62
<u>Total</u>	100.09	99.91	100.00	100.74
<u>Sp. Gr.</u>	2.72	2.72	2.67	2.72

1. Augen Gneiss. Near Hylton's, Zinc Corporation, Analysts, H. N. K. Mills, A. Morris.
2. Augen Gneiss. Amalgamated Zinc (De Bavay's). Analysts, P. Moncrieff, W. Usher.
3. "Platy" Gneiss. East of Block 14. Analysts, H.K. N. Mills, A. Morris.
4. "Platy" Gneiss. 600 yards east of British Mine, Analysts, F. H. Searcy.

BIBLIOGRAPHY

- Alexandrov, Eugene A. (1955) "Contribution to studies of the Origin of Precambrian Banded Iron Ores". Econ. Geol. Vol. 50, 1955, No. 5.
- Andrews, E. C. et al (1922) "Geology of the Broken Hill District". Geol. Surv. N.S.W., Mem. No. 8.
- Browne, W.R. (1922) same volume.
- Edwards, A.B. (1953) "Potosi Gneiss and amphibolite specimens from north of the DeBavay fault". C.S.I.R.O. Mineragraphic Investigation Report No. 564.
- Edwards, A.B. "Amphibolites from the Broken Hill District, I" C.S.I.R.O. Min. Inves. Report No. 630.
- Edwards, A.B. "Amphibolites from the Broken Hill District, II". Min. Inves. Report No. 676 Jan/1957.
- Gustafson, J. K. Burrell, H. C. and Garretty, M. D. "Geology of the Broken Hill Ore Deposit, Broken Hill, N.S.W., Australia". Bull. Geol. Soc. Amer. Vol. 61 pp 1369-1437, 1950.
- Harker, A. "Metamorphism" pp 56, 57, 121, 218.
- James (1955) Metamorphism of Bedded Ironstones. Bull. Geol. Soc. Amer. Vol. 66 p 1455-1458, 1955.
- Kenny, E.J. (1932) "The Broken Hill Lode - its Geological Structure". Proc. A.I.M.M., New Series, No. 87, 1932.
- Krumbein, W.G. and Garrels, R.M. "Origin and Classification of Chemical Sediments in terms of pH and Oxidation - Reduction Potentials". Journal of Geology, Vol. 60, No. 1 Jan. 1952.
- King, H. F. and O'Driscoll E.S. "The Broken Hill Lode". Geol. Aus. Ore Deposits Vol. pp 578-600.
- Lewis, B. R. (1957?) Structure of the Mine area, Broken Hill (unpublished Report).
- Marsh, C.W. "Geological Notes on the Barrier Ranges Silver Field". Proc. R. Soc. N.S.W. XXIV, 1890, pp 184.
- Mawson, Sir Douglas, (1912) "Geological Investigations in the Broken Hill Area". Mem R. Soc. S.A. Vol. II, pt. 4, 1912.
- Moore, E.S. (1916) "Observations on the Geology of the Broken Hill Lode, N.S.W.". Econ. Geol. Vol. II, 1916, p327.
- Ramberg, Hans "The Origin of Metasomatic and Metamorphic Rocks". 1952.
- Read, H. H. "The Granite Controversy".
- Read, H. H. "Injection complexes - Geology of Central Sutherland". Mem. Geol. Surv. Scotland, 1931. pp 88-164.

BIBLIOGRAPHY (cont.)

- Rogers, A.F. and Kerr, P. F. "Optical Mineralogy" 1933.
- Stillwell, F.L. (1956) "Sericitisation and garnetisation at Broken Hill". Private Report.
- Sokwartz, G. M. "Hydrothermal alteration of Igneous Rocks". Geol. Soc. Amer. Bull 1939. Vol. 50, p 181.
- Thomson, B.P. "Tectonics and Archean Sedimentation of Barrier Ranges, N.S.W." 1956.
- Vitanage, Piyadasa. W. "Study of Zircon Types in Ceylon Precambrian Complex". Journal of Geology, Vol. 65, No. 2, March 1957, pp 117-128.

PART IV

"ROCK SLIDE DESCRIPTIONS"

This section has been divided into four main groups.

They are:

1. The Potosi-like Gneisses.
Potosi Gneiss "A"
Potosi Gneiss "B"
Potosi Gneiss "C"
2. The Granite Gneisses.
Hanging Wall Gneiss "A"
Hanging Wall Gneiss "B"
3. The Aplites.
4. Rock Origin Suites.
 1. B.I.F., Potosi Gneiss.
 2. Granite gneiss, garnet-amphibolite.
 3. Potobolite, amphibolite.
 4. Sericite schist, biotite-amphibolite
 5. Sericite schist, hornblende-amphibolite.
 6. Sillimanite gneiss, sericite schist.
 7. Potosi Gneiss, garnet-sillimanite gneiss.
 8. Potosi Gneiss, sillimanite-biotite gneiss.
 9. Quartzite. Sillimanite-garnet gneiss.

The individual rock specimens have been examined and described under the following headings:-

Speciman Number

(Accession group A139/-, Geology
Dept., University of Adelaide).

Field Name.

Location

Macroscopic

Microscopic

(i) Texture

(ii) Mineralogy

(iii) Grain Size.

1. THE POTOSI - LIKE GNEISSES

"POTOSI GNEISS 'A' "

(Nine thin sections were examined, and five
are included in this description
section).

Specimen No. A139/4

Field Name

Garnet, biotite, feldspar granulite.

Location

DD hole W1, Delprat Cross-section, 863'

Macroscopic

A medium-grained feldspathic gneiss, with rough foliation imparted by streaks of biotite and minor sillimanite. The more important minerals are feldspar, showing good cleavage faces, quartz, garnet, biotite, sillimanite, and sericite. Garnets average $\frac{1}{8}$ " in diameter, and are granular and poorly formed. Alteration to biotite is everywhere apparent.

Microscopic

The mineral assemblage consists of quartz, feldspar, garnet, biotite, sericite and subordinate sillimanite. The matrix of quartz and feldspar is granulose, but abundant biotite, exhibiting preferred orientation, has imparted a gneissic texture on the rock. 50% of the rock is quartz, but orthoclase is not abundant. Minute inclusions of well-twinned plagioclase, biotite, magnetite and quartz grains within larger quartz crystals are common.

Long fibres of sillimanite, altering to sericite at the edges, flow around large garnet porphyroblasts. Sericite also occurs interstitially between grains of quartz and plagioclase, and is often intimately associated with small quartz granules.

Badly formed garnets are altered at the edges and along fractures to biotite and sericite. However, biotite halos are not pronounced. Inclusions of quartz grains, generally rounded, are plentiful in larger garnets.

Plagioclase, with excellent multiple twinning abounds, and the composition is that of andesite, Ab_6An_4 . The maximum extinction angle normal to O10 is 20° . 30 - 35% of the rock is plagioclase.

Plagioclase is biaxial, positive, with high 2V.

Deficiency of potash feldspar, and the abundance and mode of occurrence of sericite suggests a retrograde change from orthoclase to sericite at some stage. Crystals of orthoclase are xenoblastic, and always altered at the edges to sericite. Sericite is much more abundant than the hand specimen would suggest. Sillimanite needles have also altered at the edges to this mineral.

Accessory minerals are ilmenite, magnetite, chlorite and zircon. Biotite flakes appear to have formed around magnetite masses. Chlorite occurs as an alteration of garnet and biotite. Zircon is fairly abundant as inclusions in large brown biotite flakes, but also appears in the quartz-feldspar matrix. Grains are often elongated, but have a rounded outline. Green, isotropic gahnite is rare.

Specimen No. A139/88

Field Name

Garnet, biotite, feldspar granulite.

Location

Surface outcrop north of North Broken Hill No. 3 shaft.

Macroscopic

A coarse-grained garnet, biotite, feldspar rock, with abundant pink almandine and black biotite. Gneissic texture is weakly developed, although biotite flakes exhibit a strong preferred orientation. Large spherical garnets are enveloped by thick segregations of biotite, forming pronounced biotite halos. Quartz grains are small, but occasionally reach 1/16" in diameter. This mineral is a translucent blue colour. Feldspars are somewhat weathered, but the rock is very rich in plagioclase.

Microscopic

This is a garnet, biotite, plagioclase gneiss which has been badly sericitised. The texture is faintly gneissic, with biotite imparting a rough foliation. However, quartz and plagioclase grains show no signs of strain or preferred orientation. Plagioclase comprises 30% of the rock, as well-twinned xenoblasts. The maximum extinction angle normal to $O10$ is 26° , and the composition is that of andesine, Ab_5An_5 .

50% of the slide is quartz. Grains are very irregular in shape, and often separated by interstitial sericite. Inclusions of dust-size material are plentiful within these xenoblasts. Quartz and plagioclase occur in intimate intergrowth as myrmikite. The average grain diameter is 0.5 mms, but larger grains of quartz may reach 2 mms.

Garnets are small and always altered to sericite and biotite. Often only relics remain.

Biotite is abundant, and of a dark brown strongly pleochroic variety. Two habits are evident. Large individual flakes containing zircon inclusions, and aggregates of minute flakes often associated with magnetite.

The rock is deficient on orthoclase, and potash occurs mainly in sericite mica, and biotite.

Apatite and zircon are rare, and magnetite is not abundant.

Specimen No. A139/87

Field Name

Garnet, biotite, feldspar granulite.

Location

Surface outcrop north of No. 3 Shaft, North Broken Hill.

Macroscopic

A medium-grained garnet, biotite, feldspar gneiss with a weak foliation. Garnets are small, often $\frac{1}{8}$ " in diameter, and usually intensely altered to biotite. The rock is very feldspathic, although it contains a high percentage of quartz. Quartz grains may be as large as $\frac{1}{16}$ " in diameter, and is normally a smoky brown colour, with no bluish tinge. Segregation of salics on the one hand, and biotite layers on the other is apparent in the hand specimen, but no veining occurs. Garnet is not as plentiful as expected, and most of the iron occurs as biotite.

Microscopic

An orthoclase, plagioclase, biotite gneiss, with subordinate garnet. The texture is granoblastic, although a faint gneissosity is imparted by biotite and sericite flakes. Biotite is commonly intergrown with sericite. It appears to be changing to sericite in places, with release of magnetite. Garnets are very small and altered to sericite and biotite. The main textural feature is the xenoblastic nature of the dominant minerals.

Quartz constitutes 50% of the slide. Grains are clear, and contain few inclusions. Outlines are very irregular, and often marked by wisps of sericite.

Feldspars are abundant, with plagioclases the dominant species. Orthoclase, however is fairly abundant, although often altered to sericite. Twinned plagioclase has a maximum extinction angle measured from sections normal to 010 of $+17^{\circ}$. The composition is that of andesine.

Crystals are biaxial, negative 2V is high 25% of the rock is plagioclase.

Biotite occurs as ragged flakes or aggregates, and is strongly pleochroic. Thus

x = light brown
y = dark brown

There are relatively few inclusions of zircon. Biotite is usually associated with grains of magnetite, or as an alteration of almandine.

Ilmenite, zircon, and rusty-coloured hematite are rare. Hematite is an alteration product of biotite.

Quartz and feldspar grains are similar in size (from 0.5 - 1 mm in diameter). Garnets are small, often 0.5 mm diameter, and late reaction and dispersion has fragmented early-crystallised larger garnets.

Specimen No. A139/93

Field Name

Garnet, biotite, feldspar, sericite gneiss.

Location

DD hole 631, Zinc Corpn. Ltd., core, 784'.

Macroscopic

A coarse-grained gneiss, veined by pegmatitic material. Garnets are large and irregular in shape, and are often broken-up and altered to biotite and minute flakes of sericite. Blue quartz abounds, and the rock is particularly silicious. Large areas, possibly originally feldspars, have almost completely changed to sericite.

Microscopic

This is a quartz, feldspar, garnet, biotite gneiss. Preferred orientation of biotite and sericite flakes, imparts a foliation on the rock. Garnet porphyroblasts are often $\frac{3}{8}$ " in diameter, and flattened in the plane of foliation. Biotite halos are common.

The gneiss is badly sericitised, sericite flakes occupying cracks or fractures in or around quartz and feldspar xenoblasts. Garnets have likewise altered at the edges to biotite and sericite. Small flakes of biotite have grown outwards from larger plates, roughly normal to the foliation. Lensy segregations of magnetite parallel the larger biotite flakes.

Pink almandine garnets, up to $\frac{1}{2}$ " long, contain numerous inclusions of irregularly shaped quartz grains. The larger the garnet, the more numerous are these inclusions. All garnets have been cracked and dissected, and the fissures filled with sericite. It is notable that in the vast majority of cases, sericite rather than biotite fills these fractures.

Orthoclase is not abundant, and has altered to sericite. Plagioclase, however, is common and comprises 25-30% of the rock. It is somewhat sericitised at the edges. Optical characteristics were distinctive, the grains being biaxial, negative. $2v = 75^\circ$ coarse multiple twinning is evident, and extinction angles measured normal to $O1O$ give a maximum of $+20^\circ$. The composition is thus andesine.

Magnetite is subordinate, and zircon and apatite rare.

The grain size of this specimen is relatively large, in accordance with a more pegmatitic nature. Quartz, which occurs to the extent of 45-50% of the slide, may exist as xenoblasts several mms in diameter.

Specimen No. A139/2

Field Name

Garnet, biotite granulite.

Location

DD hole E 2 Delprat Cross-section, 614'

Macroscopic

A coarse-grained garnet, feldspar, biotite gneiss, with abundant black biotite and large pink garnets altered marginally to sericite and biotite. A coarse foliation is imparted by layers of biotite and quartz-feldspathic vein material which forms segregated layers. Garnets are large, often $\frac{1}{4}$ " in diameter, but of irregular shape. Likewise the vein quartz is of large grain size. Quartz is a peculiar translucent blue, and this colouration along with scattered iron-staining suggests some affinity with the lode. (Lode quartz is typically blue).

Microscopic

T This is a quartz, feldspar, garnet, biotite gneiss with subordinate magnetite and a good development of sericite. Quartz and feldspar crystalloblasts are predominantly equidimensional, and show no signs of strain or elongation. However, alteration of schistose biotite-sericite bands and these granulose salic layers imparts a strongly gneissose structure on the rock. Magnetite masses are intimately associated with biotite flakes, and seemingly stretched-out in the plane of foliation.

Large pink almandine porphyroblasts have broken apart, and suffered extensive alteration to sericite and biotite. Biotite probably formed first, as a halo about the garnet, but was pushed aside by a later and more rapid, growth of sericite.

Plagioclase crystals are twinned on the simple albite law. This mineral, andesitic in composition, is much more abundant than orthoclase 30% of the slide is plagioclase. It is biaxial, negative, and 2v is moderate to high. Orthoclase crystalloblasts are mainly relics, altered largely to sericite. Myrmekitic intergrowth between quartz and plagioclase is present, but rare.

Quartz grains are often very large and porphyroblastic, some approaching 4 mms in length. Most crystals are clear, with few inclusions, and bounded by wisps of sericite. 40% of the rock is free quartz.

Accessory minerals are hard to find in this section. A few zircon inclusions in biotite, surrounded by a characteristic pleochroic halo, were noticed. Magnetite and ilmenite are more abundant.

Grain size is variable, but most crystals are approximately 1 mm. in diameter. As mentioned previously, large porphyroblasts of quartz, 4 mms across do occur more rarely. Garnets are so dispersed and broken apart that a size is hard to estimate. Before sericitisation they may have been rather large.

"POTOSI GNEISS 'B' "

(fourteen thin sections were examined; five have
been included in this section).

Specimen A139/97

Field Name

Garnets, biotite, feldspar granulite

Location

Surface outcrop on Zinc Corp. Ltd., leases (mine).

Macroscopic

This rock is very good Potosi Gneiss. It is a moderately coarse-grained grey gneiss of a granular nature, composed chiefly of feldspar, quartz, biotite and garnet. Garnets are numerous, and usually from $\frac{1}{8}$ " to $\frac{1}{4}$ " in diameter.

Macroscopic

A quartz, plagioclase, garnet, biotite gneiss, with granulose structure. Preferred orientation of brown biotite flakes is weak, and thus gneissose texture is but faint. Plagioclase xenoblasts are numerous, and 25% of the slide is comprised of this mineral. Quartz also is abundant, perhaps to the extent of 40% of the rock. Large pink almandine garnets, usually badly formed, and containing many rounded quartz grains as inclusions are present. The rock has been somewhat sericitised, and often the garnets have fractures filled with minute flakes of sericite.

Plagioclase is well-twinned, and has suffered little or no alteration. Pericline and simple albite twinning is common. The composition is that of labradorite, $Ab_{41}An_{59}$, decidedly calcic. Myrmekitic intergrowth between quartz and labradorite is wide-spread. Orthoclase is rare.

Biotite occurs as small ragged flakes of a dark brown colour, and is strongly pleochroic. Pleochroic halos, due to small zircon inclusions, are sometimes present. Flakes of biotite often envelop larger garnet porphyroblasts.

As mentioned previously, sericite is not as abundant as in other specimens of this gneiss. However, many garnets are just relics set in a mass of felted sericite flakes. Zircon, apatite and magnetite are rare.

The grain size is not large, but quite even. Most quartz and plagioclase crystalloblasts are 1 mm in diameter. Garnets are larger, usually 2-3 mms.

Specimen No. A139/14

Field Name

Siliceous garnet, biotite gneiss.

Location

D.D. hole 691, Delprat cross-section 195' - 197'

Macroscopic

The rock is a coarse-grained siliceous gneiss, with conspicuously large garnets. Thick black envelopes of biotite form halos about these garnet porphyroblasts. Sericite is equally as abundant as biotite, as can be ascertained by breaking the core parallel to the foliation planes. Blue quartz abounds, and occurs in coarse veins parallel to biotite layers.

Microscopic

A quartz, plagioclase, orthoclase, biotite, garnet gneiss. Preferred orientation of biotite and sericite is strongly developed. The rock has been badly sericitised, and large flakes of sericite are present. Smaller flakes fill fractures and cracks of large pink garnets.

Orthoclase is rare, and plagioclase is the dominant feldspar. However this is not as abundant as expected - only 5% of the slide. The composition is andesine, Ab_5An_5 . Extinction angles measured normal to $O10$ are high, the maximum being 30° .

Sillimanite occurs as fine needle-like idioblasts of high relief, but is not abundant.

Biotite is strongly pleochroic, and inclusions of zircon have produced dark brown pleochroic halos. Alteration to light-green chlorite has occurred in places.

Accessory minerals are ilmenite, which is abundant in places, zircon, galena, and apatite.

Quartz grains are xenoblastic, and contain few inclusions. 65% of the slide is quartz. The average grain diameter is 1.2 mm, although larger grains of 3 mms diameter occur. The rock is rather "veined" in the hand specimen, and coarse grain size was expected. Garnets are larger than is usual for B, and average 3 mms diameter.

Specimen No. A139/56

Field Name

Siliceous garnet granulite.

Location

D.D. hole 819, North Broken Hill core, 540'

Macroscopic

This rock shows no sign of aligned mica, and has a granoblastic texture. Large pink garnets, often $\frac{1}{4}$ " in diameter, are relatively unaltered. Indeed, biotite is rather deficient. Quartz is of the translucent blue variety, and approximately 60% of the slide is blue quartz. Feldspars are not abundant and appear in the hand specimen to have been sericitised partially.

Microscopic

A quartz, plagioclase, garnet, biotite gneiss. The rock is coarsely granulose. Xenoblasts of fresh quartz and plagioclase are dominant. Garnets do not abound, but those present are often $\frac{1}{8}$ " in diameter. They have irregular outlines, and contain numerous quartz inclusions. Sericite flakes are intimately associated with most garnet porphyroblasts.

Biotite does not occur as large isolated flakes, but as wispy aggregates often associated with ilmenite masses.

Plagioclase is very well twinned on the albite law. The composition is $Ab_6 An_4$, andesine. It is biaxial, positive, and $2v = 80^\circ$. The maximum extinction angle measured from sections normal to O10 is 24° . Most grains are clear and fresh, but occasional crystals have altered to sericite 10% of rock is plagioclase. Orthoclase is rare and it is suspected that much of the sericite represents decomposed potash - feldspar.

Of lesser importance are ilmenite (or magnetite), sphene, apatite and zircon.

The grain size is larger than expected. Quartz, and less frequently, plagioclase, are often 2 mms wide. Garnets are smaller, but may reach $\frac{1}{8}$ " in diameter.

Specimen No. A139/96

Field Name

Garnet, biotite, feldspar gneiss.

Location

D.D. hole 1152, Zinc Corp. Ltd., core, 480'

Macroscopic

A rather fine-grained gneiss characterised by feldspar-quartz veining, giving it a coarse banding. Biotite is not abundant, but sufficient to cause a faint semblance to foliation. Garnets are small, often less than 1/16" in diameter, and altered to biotite. Large quartz grains are of a translucent blue colour. The rock is very siliceous and feldspars are not abundant.

Microscopic

A quartz, orthoclase, garnet, sillimanite gneiss, with subordinate biotite and plagioclase. The texture is gneissose; elongated quartz, feldspar and garnet xenoblasts are oriented parallel to needle-like sillimanite crystals and wisps of sericite. Sericitisation is widespread, probably as an alteration of feldspars and sillimanite. Garnets are normally fresh and contain few inclusions. Biotite halos are not common. Zoisite occurs as a few rare irregular grains with anomalous birefringence.

Grains of plagioclase are rare, and twinning is usually indistinct. The composition is labradorite, Ab_4An_6 . Orthoclase is by far the most abundant feldspar, occurring as large xenoblasts usually rimmed by sericite flakes.

Sillimanite is abundant as long fibres of high relief. These have undergone alteration at the edges to sericite. Sillimanite is visible in the hand specimen.

A few flakes of biotite are present, but the rock is quite low in this mineral. Magnetite is also rare. Zircon and several large grains of apatite are accessory minerals.

Grain size is variable, but large crystalloblasts of both quartz and feldspar occur. These may reach 4 mms in diameter. Garnets average 1mm, but porphyroblasts $\frac{1}{8}$ " in diameter are also present.

Specimen No. A139/99

Field Name

Garnet, biotite, feldspar gneiss.

Location

Surface outcrop near Rising Sun North shaft.

Macroscopic

The rock is a fairly coarse-grained siliceous granulite composed largely of quartz, garnet and biotite. Biotite halos are frequent about small garnets.

Gneissic texture is faintly present. The gneiss is composed of xenoblasts of quartz, orthoclase and plagioclase, with abundant porphyroblasts of pink garnet. Alteration of garnet to dark brown biotite is pronounced in the hand specimen and under the microscope. Numerous inclusions of rounded quartz grains and tiny magnetite particles occur. Edges and fractures are filled with wisps of sericite. Fine-grained aggregates of sericite and quartz occur as individual masses and interstitially between quartz and feldspar grains.

Quartz abounds, and 50% of the rock would be free quartz. The average grain size is 0.8 mms in diameter.

Plagioclase and orthoclase occur, but orthoclase is subordinate. The plagioclase grains are calcic, and the composition is Ab₅ An₅; that of andesine. It is biaxial, negative. The maximum extinction angle normal to O10 is 25°.

Biotite and sericite are common as alteration products, but little is primary. Ilmenite, apatite and zircon accessories.

Garnets are small, only 1/16" in diameter is usual. However, they are extensively altered to biotite.

"POTOSI GNEISS 'C' "

(Nine specimens were examined in thin section,
and four slide descriptions have been included
in this section).

Specimen No. A139/21

Field Name

Garnet, feldspar, quartz granulite.

Location

DD hole 783, Delprat cross-section, 57'

Macroscopic

A very siliceous granulite, composed largely of blue quartz and granular pink garnets, with subordinate feldspar and biotite. The garnets are but slightly altered, and biotite halos are not apparent. Biotite is only minor, but imparts a faint directional structure on the rock. A few small crystals of iron sulphides, possibly pyrrhotite were observed.

Microscopic

The rock is a quartz, orthoclase, garnet, biotite gneiss. Texture is essentially granulose, with a faintly transitional foliation due to aligned but disconnected flakes of biotite, and long streaks of sericite. Quartz, orthoclase and plagioclase predominate, and although xenoblasts show no signs of elongation there are several instances of strain shadows in larger quartz grains. 65% of the slide is quartz, with 5% orthoclase, and between 5 and 10% plagioclase.

Large pink almandine garnets are abundant, and have suffered little alteration. In many cases these garnets are completely fresh, although others have changed to biotite at the edges, and contain sericite wisps between fractures and as inclusions. Quartz inclusions are common, and usually of irregular shape and rimmed with sericite.

Quartz grains are very irregular in shape, and sometimes rimmed with sericite. Large grains are often cracked, and these fissures although very fine, have been filled with sericite. Frequently these larger grains show signs of strain. Quartz in this slide contains few small inclusions, although larger masses may include smaller flakes of biotite, irregular grains of twinned plagioclase, or rounded quartz grains.

Plagioclase is poorly twinned, and occurs as small xenoblasts. The composition is decidedly calcic-anorthite. It is biaxial, negative, and $2v = 80^\circ$.

Orthoclase has largely altered to sericite. Biotite occurs as scattered flakes of reddish-brown colour, and shows a preferred orientation, paralleling the streaks of sericite. It is strongly pleochroic from light brown to dark reddish-brown, and frequently contains inclusions of magnetite and zircon. The latter has produced small pleochroic halos.

Zoisite, ilmenite, pyrite (or pyrrhotite), apatite, and zircon are rare.

The average grain size is $\frac{1}{2}$ mm, but quartz grains are variable, and several large crystals $1\frac{1}{2}$ mms in diameter are present. Plagioclase, notably deficient in this rock, occurs as much smaller grains of about 0.3 mms in diameter. Garnets vary from 0.8 mms to 2.5 mms. The average size is 2 mms.

Specimen No. A139/95

Field Name

Siliceous garnet, biotite granulite.

Location

D.D. Hole 1152, Zinc Corp. Ltd., core, 975'

Macroscopic

A siliceous garnet biotite granulite composed largely of plentiful small pink garnets of spherical shape, layers of blue quartz, and disconnected bands of black biotite. Grain size is small, and garnets are only 1/16" in diameter.

Microscopic

This rock is a quartz, garnet, biotite gneiss with subordinate feldspar and pronounced sericite development. A few grains of poorly-twinned plagioclase were determined. Quartz, rimmed with wispy sericite, often contains small inclusions. 60% of the slide is quartz. Grains are very irregular in shape, and elongated such that the long axes parallel biotite flakes. Evidence of strain in layer crystals is apparent.

Characteristic of this specimen is the more pronounced banding due to an increase in biotite content and elongation and layering of quartz grains. Biotite, a dark brown variety, is abundant, but few large flakes occur. It consists of aggregates of minute flakes apparently of random orientation. Garnet has altered to biotite in some instances.

Garnets are very abundant, and usually rounded in shape. Alteration has not been intense, and biotite halos are pronounced. Many garnets, although badly fractured, are quite compact, and only a minor development of sericite has occurred within these cracks. Quartz inclusions within the garnets are small in size, and usually of a rounded nature.

Plagioclase xenoblasts are untwinned in the majority of cases, but have a higher relief than neighbouring quartz grains, and are easily recognisable 5-10% of the slide is plagioclase. It was not possible to determine the composition accurately. Orthoclase is rare.

Ilmenite and zircon are accessory in amount.

Grain size is not consistent, and in the case of quartz, all gradations in grain diameter, exist to an upper limit of 2mms. Plagioclase crystals are smaller, usually 1/2 mm in diameter. Garnets are normally 2 mms wide, and do not vary much from this figure.

Specimen No. A139/15

Field Name

Garnet, feldspar, quartz granulite

Locality

D.D. hole 805, Delprat cross-section, 1029'

Macroscopic

A silicious garnet granulite with a poorly-defined foliation imparted by aligned flakes of biotite. Garnets are rounded and generally unaltered, although a polished surface reveals some sericitisation at the edges. Blue quartz is abundant, but there are no traces of mineralisation. Feldspars have been sericitised.

Microscopic

A quartz, orthoclase, garnet, biotite gneiss which possesses a faint directional texture. Long streaks of sericite and small, ragged flakes of biotite are set in a granoblastic matrix of quartz and minor feldspar. Plagioclase is rare, but several finely-twinned xenoblasts are present. Garnets are small, usually 1/16" in diameter, and slightly altered to biotite and sericite. Sericitisation is intense, and all feldspars show signs of alteration. Several large inclusions of sericite are present within plagioclase grains.

Biotite is not abundant, and most flakes are small. Inclusions of magnetite are common. Biotite is strongly pleochroic from light brown to dark brown, with no reddish tinge.

Plagioclase is biaxial, positive, and has a high 2v. The maximum extinction angle normal to O10 is 30°. It is labradorite, Ab₅An₅. 5%, or less, of this rock is plagioclase. Orthoclase is more abundant, but the rock as a whole is very silicious, and feldspars are subordinate in amount.

Well-rounded crystals of zircon, and small colourless apatite plates are rare. Magnetite (or ilmenite) is also accessory.

Grain size is very variable, but most quartz crystals average 1/2 mm in diameter. Large porphyroblasts also occur.

Specimen No. A139/16

Field Name

Silicious garnet, feldspar granulite.

Location

D.D. hole 805, Delprat cross-section 1054'.

Macroscopic

This rock is very similar to A139/15, with the possible difference lying in degree of sericitisation. Long streaks of sericite parallel the faint directional texture caused by aligned biotite. A fresh surface shows sugary patches, which probably represent partially altered feldspars.

Microscopic

The mineralogy is essentially the same as A139/15, but a few points are worthy of mention.

Sericitisation is pronounced, feldspars having altered almost completely to sericite. Interstices of quartz fractures in large garnet porphyroblasts have been filled by sericite flakes.

Biotite occurs as aggregates of small flakes rather than as large individual plates. Pleochroism is strong, from light yellow brown to dark brown.

Grain size is variable, but the rock is largely fine-grained. Larger quartz xenoblasts show signs of strain, with undulose extinction. Garnets are normally $\frac{1}{8}$ " in diameter, and frequently contain quartz inclusions.

Magnetite, zircon and apatite are rare.

2. THE GRANITE GNEISSES.

"HANGING WALL GNEISS 'A' "

(eleven thin sections were cut, three have
been described in this
section).

Specimen No. A139/5

Field Name

Hanging Wall Gneiss.

Location

D.D. hole E3, Delprat cross-section, 1971'

Macroscopic

A coarse-grained biotite, sericite, feldspar gneiss. The rock is very feldspathic, and also contains a good development of sericite. Large masses of sericite envelop relics of garnet so that at first glance the garnets appear light brown in colour rather than pink. Gneissic biotite banding is pronounced.

Microscopic

A quartz, plagioclase, biotite gneiss, with marked segregation of biotite layers and lenticles of quartz and feldspars. Sericite flakes are small but well-formed, and parallel those of biotite. The texture is coarsely gneissic, and a preferred orientation of biotite flakes is apparent in thin section.

30-40% of the rock is quartz. Crystals are typically xenoblastic and contain myriads of minute inclusions. Porphyroblasts occur, and usually show evidence of strain, with undulose extinction and fracturing. Intergrowth with plagioclase has produced myrmekite.

Orthoclase is also abundant, as xenoblasts sometimes porphyroblastic, and often twinned on the Carlsbad law. 5-10% of the rock is orthoclase. Plagioclase is equally abundant, and xenoblasts, usually smaller than quartz grains, are coarsely twinned. The maximum extinction angle normal to 010 is $+15^{\circ}$, and the composition is oligoclase.

The biotite forms large crystals with pleochroic halos and rounded zircons. Smaller flakes also occur in aggregates. It is strongly pleochroic from light brown to dark reddish brown. Sericitisation is widespread, and flakes are larger than usual, and well-formed. They are aligned, in the general direction of foliation parallel to larger biotite crystals.

Apatite and zircon are not abundant.

Grain size is very inconsistent, however the average diameter of quartz crystals is 0.5 mm.

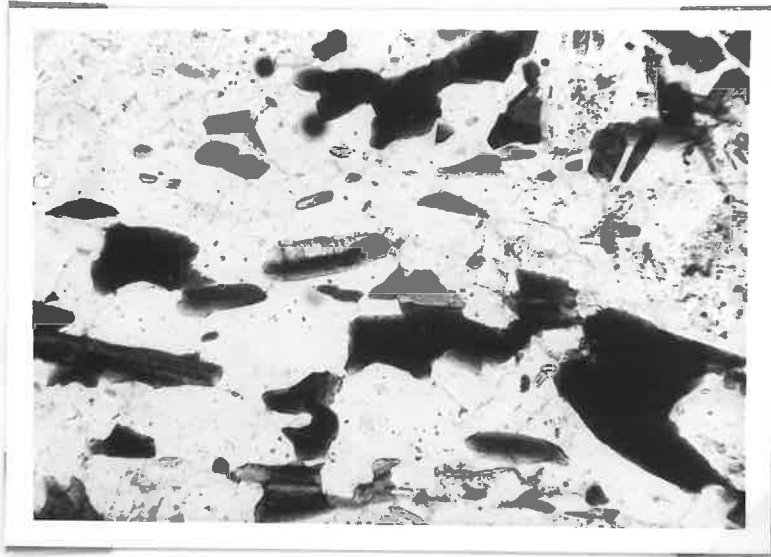

Figure 14. Hanging Wall Gneiss "A"

Photograph X of a thin section of A139/5. The section was cut normal to the gneissic banding and shows a strong lineation of black biotite flakes. Quartz grains contain numerous inclusions, mainly small wisps of biotite. Elongate zircons are also visible.

Specimen No. A139/8

Field Name

Hanging Wall Gneiss.

Location

D.D. hole W1, Delprat cross-section, 1782'

Macroscopic

A coarse-grained granitic gneiss with prominent platy crystals of feldspar and a pronounced gneissose texture caused by aligned flakes of biotite. Garnet is subordinate, and largely sericitised.

Microscopic

The rock is mainly composed of quartz, orthoclase, plagioclase and biotite, with a minor development of garnet. The rock has a distinct gneissic texture, with aligned biotite flakes wrapped around coarse grains of quartz and feldspar. Segregations of biotite flakes are separated by lenses of quartz and feldspar. Quartz grains are elongated in the plane of foliation, and undulose extinction in several cases provides evidence of stress. Minute flakes of sericite are scattered throughout, both as unoriented aggregates and marginally between quartz and feldspar grains. In many cases, sericite is closely associated with biotite. Garnets are rare, and have been sericitised. They occur as small irregular aggregates set in wisps of sericite and, to a lesser extent, associated with biotite.

Feldspar is abundant, and both orthoclase and plagioclase occur. The former is xenoblastic, and is twinned on the Carlsbad law. Several porphyroblasts are present, and the hand specimen suggests that these are quite numerous 10% of the rock is potash feldspar.

Plagioclase xenoblasts are twinned on the simple albite law. Twinning is fairly coarse. Crystals are fresh and clear, although inclusions of quartz, biotite and sericite are numerous.

The maximum extinction angle normal to $O10$ is $+12^{\circ}$, and the plagioclase is oligoclase. Intergrowth between quartz and plagioclase - myrmekite - has occurred. 15-25% of the rock is plagioclase.

Biotite abounds, and the usual habit is that of masses of ragged flakes, rather than as large individuals. It is strongly pleochroic:

x = light brown
y = dark brown

Preferred orientation is obvious. Small zircon inclusions are abundant, and pleochroic halos have formed about them.

Grains are not of consistent size, and all gradations exist up to quartz porphyroblasts several mms. in diameter. Garnets are small and badly corroded, usually completely engulfed with moss-like sericite. Most fragments are only a fraction of a mm. in diameter.

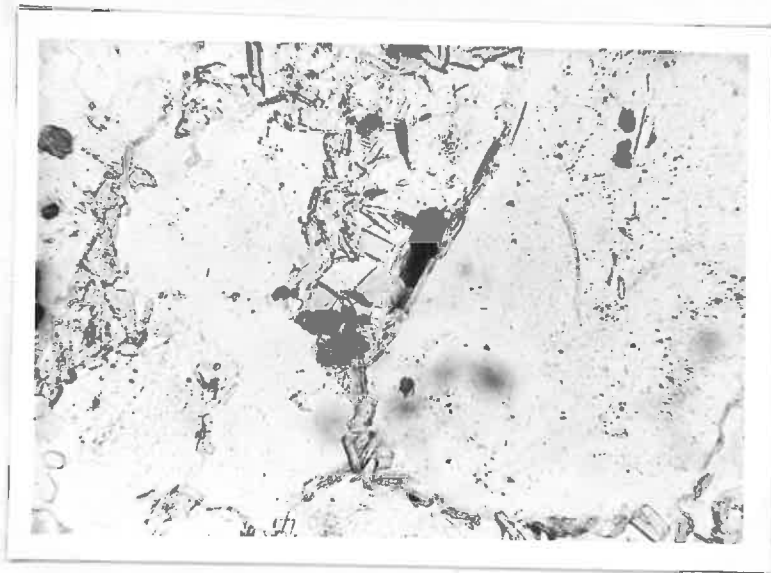

Figure 15 - Hanging Wall Gneiss "A"

Photograph X of A139/8 in thin section. This rock was intensely sericitised and the photograph shows the minute, often idioblastic, flakes of sericite outlining quartz and feldspar xenoblasts.

Specimen No. A139/90

Field Name

Hanging Wall Gneiss.

Location

Surface outcrop north of No. 3 shaft, North Mine.

Macroscopic

A grey feldspathic gneiss, with abundant feldspar, quartz and biotite, and little garnet.

Microscopic

The rock is a coarse-grained granite gneiss, essential minerals being quartz, plagioclase and biotite, the last containing tiny inclusions of magnetite. There is no tendency for segregation of feldspars and quartz as opposed to biotite-rich layers, and gneissic texture is not strongly developed.

Quartz is abundant, and larger xenoblasts exhibit undulose extinction or strain shadows. Grains are irregular, but not angular, and few inclusions are present. 30-40% of the slide is quartz.

Large xenoblasts of plagioclase are of andesitic composition. These are very coarsely twinned, and twinning is particularly sharp and clear. The maximum extinction angle normal to 010 is 30° , corresponding with Ab_5An_5 . No zoning is evident, nor any signs of alteration. At least 35% of the rock is andesine. Orthoclase is rarer.

Large biotite flakes are well-formed and show preferred orientation. The flakes are strongly pleochroic from light brown to dark reddish brown.

Garnet porphyroblasts occur, and are altered both at the edges and along fractures to green, slightly pleochroic chlorite, and brown biotite. Quartz grains of varying dimensions are crowded between cracks.

Zircon and apatite are rare, and sericite is almost entirely absent.

The rock is remarkably even-grained, most grains having diameters between 0.5 and 1.0 mm.

"HANGING WALL GNEISS 'B' "

(eleven thin sections were examined, and six have been described in this section).

Specimen No. A139/55

Field Name

Biotite, feldspar gneiss.

Location

D.D. hole 836, North Broken Hill Ltd., core 1200'.

Macroscopic

A feldspathic gneiss composed mainly of quartz, feldspar and biotite, with no garnet. Large augen of feldspar are present, and the rock is rather veined in places by this material. Gneissic banding is strongly developed.

Microscopic

Quartz, plagioclase, orthoclase, biotite gneiss of coarsely gneissose structure. Biotite crystals are segregated into lensy masses of parallel orientation in a granulose matrix of quartz and feldspars. Sericitisation is widespread, and fine-grained flakes of sericite are randomly oriented. Larger flakes parallel the foliation. Quartz grains are not elongated, but larger xenoblasts show evidence of strain. Garnet is almost entirely absent.

Quartz, often containing myriads of minute inclusions of smaller quartz grains and flakes of biotite, is very abundant - perhaps 60% of the slide. The rock is deceptively siliceous - deceptively because large plates of feldspar are numerous in hand specimens.

Plagioclase and orthoclase are moderately abundant, with the former predominant. Grains are irregular in shape, and multiple twinning is fine and sharp, permitting an accurate estimation of extinction angles. The maximum normal to O10 is $+ 11^{\circ}$ and the composition is $Ab_{7}An_{3}$, oligoclase.

Biotite is very plentiful, and occurs as large ragged flakes of a rich brown colour. It is strongly pleochroic and contains numerous zircon inclusions.

Magnetite and zircon crystals are rare, and garnet is present only as relics in larger biotite aggregates.

The average grain size is 0.8 mms, but several plagioclase porphyroblasts are 2 mms in diameter.

Specimen No. A139/58

Field Name

Garnet, biotite, feldspar gneiss.

Location

North Broken Hill Ltd., core.

Macroscopic

This is a coarse-grained feldspathic gneiss, with numerous large elongated pink garnets. Biotite is not abundant. However, it imparts a coarsely banded appearance to the rock. Long streaks of sericitised sillimanite are visible in the hand specimen.

Microscopic

A garnet, sillimanite, quartz, biotite, plagioclase, gneiss, has a pronounced foliation caused by oriented sillimanite needles, flakes of biotite, and elongated garnet porphyroblasts. These large garnets are altered along fractures and peripheries to biotite, and contain numerous fine silvers of sillimanite inclusions. Inclusions of irregular-shaped quartz grains and flakes of biotite are also common within these large grains, often $\frac{1}{2}$ " long. Sillimanite, as felted masses and long needles, is closely associated with biotite, and a very minor development of sericite.

Quartz grains are xenoblastic, and outlines are marked in many cases by a marginal development of sericite. Larger crystalloblasts contain inclusions of small biotite crystals. 50% of the rock is quartz.

Plagioclase is twinned on the albite and Pericline laws. However, few sharply defined twins exist. Extinction angles normal to O10 show a maximum of $+20^\circ$. The feldspar is andesine. It is biaxial, negative, and 2V is high. 5-10% of the rock is plagioclase. Orthoclase is not very abundant, and plagioclase is the dominant feldspar.

Disconnected, parallel oriented biotite flakes are abundant. This is of a rich brown colour, and is strongly pleochroic from light yellow brown to dark purplish brown. Pleochroic haloes frequently occur in larger flakes, and tiny zircon inclusions, usually rounded, are visible.

Sillimanite is very abundant as long needles of high relief and parallel extinction. There is no sign of any alteration at the edges.

Apatite, magnetite and zircon are accessory.

The matrix of quartz and plagioclase is granular, and the average grain diameter is 1 mm or slightly less. Garnets (and quartz grains) have quite obviously been stretched-out along the plane of foliation. One mass was $\frac{1}{2}$ " long and $\frac{3}{16}$ " wide. The average diameter of garnets, however, is $\frac{1}{4}$ "

Specimen No. A139/69

Field Name

Feldspathic garnet, biotite gneiss.

Location

D.D. hole 837, North Broken Hill Ltd., 1280'

Macroscopic

This gneiss is a very feldspathic variety, with abundant large elongated garnets. Biotite and sillimanite are not very abundant.

Microscopic

The rock is a plagioclase, orthoclase, garnet, biotite, sillimanite gneiss, but gneissic texture is not strongly developed because of a deficiency of biotite.

Quartz abounds as colourless xenoblasts. One crystal provides evidence of a probable pre-existing grain boundary - a growth not in optical continuity. Most outlines are emphasized by rims of sericite leaflets. Inclusions of the particles, quartz and mica mainly, are numerous. 45-50% of the slide is quartz.

Plagioclase comprises 10% of the rock, and orthoclase is somewhat less abundant. The former shows multiple twinning, but this is not clear. Extinction angles measured normal to $\theta 10$ are low, with a maximum of 10° oligoclase. It is biaxial negative, and $2V = 80^\circ$. Some grains contain quartz inclusions, and an intimate intergrowth (myrmekite) is rare. Weak sericitisation at the edges and cleavages is evident.

Biotite occurs as well-formed brown flakes, exhibiting strong pleochroism from light brown to dark reddish brown. Inclusions of magnetite, often at the edges, and of rounded zircons are common. Pleochroic haloes have formed around the radioactive zircons.

Sillimanite is prismatic in habit, but often, cross-sections normal to the long axis can be seen. These results are of amazingly large grain size, and of perfect crystal shape. A feature of this occurrence is the non-felted nature, long slender prisms predominating as individuals.

Garnets are large and relatively unaltered. Large porphyroclasts, often $\frac{3}{8}$ " in length, and filled with hair-like inclusions of sillimanite. Inclusions of rounded quartz grains are numerous. Biotite and slightly pleochroic green chlorite are also associated with these garnets.

Magnetite is not plentiful, except as minute disseminations in flakes of biotite. The iron content of the rock is concentrated in large and numerous garnets. Zircon is also rare.

The rock is coarse-grained, and apart from garnet porphyroblasts is fairly even grained.

Specimen No. A139/81

Field Name

Feldspathic garnet, biotite gneiss.

Location

D.D. hole 830, North Broken Hill Ltd., core 540'

Macroscopic

A rock very similar in appearance to A139/55, with a slightly greater development of garnet. Most garnets are as light pink colour, and badly shaped. Long fibres of sillimanite are visible. Biotite is not abundant, but thin streaks form a rough gneissic texture.

Microscopic

A coarse-grained gneiss with preferred orientation shown by biotite and sericite. Sericite has formed around needles of sillimanite, and also as an alteration product of potash feldspars. It is particularly plentiful in this slide. A feature of the sericite is the random orientation of tiny individual flakes, although the matted aggregate as a whole parallels the foliation surface. Plagioclase is the most conspicuous feldspar, and occurs to the extent of about 5-10% of the rock. Quartz grains are very abundant, and 50-60% of the slide is quartz. Most grains, even those of small grain size, show some sign of strain, with marked undulose extinction. Garnet is absent in the slide, but moderately plentiful in the hand specimen.

Plagioclase xenoblasts are rather indistinctly twinned. The composition is fairly sodic, in the oligoclase range. It is biaxial, and both positive and negative signs were obtained. 2V is high.

Brown pleochroic flakes of biotite usually contain inclusions of magnetite.

Zircon, and more rarely, apatite and accessories. Myremakite is fairly abundant.

Grain size is coarse, and quartz grains may reach several mms in length.



Figure 17. Hanging Wall Gneiss "B"

This photograph (X70 approx.) of thin section A139/81 shows the alteration of sillimanite to sericite mica. Sillimanite is quite abundant in this rock. Small strings of garnet can also be seen.

Specimen No. A139/84

Field Name

Garnet, biotite, feldspar gneiss.

Location

D.D. hele 827, North Broken Hill Ltd., 720'

Macroscopic

A dark gray siliceous gneiss with abundant feldspar-quartz veining. Garnets are large but poorly formed, and streaks of sillimanite and biotite impart a distinct foliation.

Microscopic

The rock is a quartz, feldspar, biotite gneiss with abundant large garnets and subordinate sillimanite and sericite. Oriented lenticles of brown biotite appear in a matrix of xenoblastic quartz and feldspar. Sillimanite needles and threads parallel to biotite, impart a rough foliation on the rock. Large garnet porphyroblasts are elongated and broken apart, and contain inclusions of needles of sillimanite. Small flakes of sericite fill fractures in these crystals, but biotite is equally prominent in places. Irregular quartz and feldspar grains show peripheral sericite development. 50% of the rock is quartz.

Plagioclase is biaxial, negative, and $2V = 80^\circ$. Twinning is not distinct and the maximum extinction angle normal to $O10$ is $+10^\circ$. The composition is that of oligoclase, Ab_7An_3 . 5% of the slide is plagioclase. Orthoclase is not very abundant, and is present to about the same extent as plagioclase.

Sillimanite is often altered at the edges to sericite. Very good basal sections occur, the slide having been cut normal to the prisms. It is biaxial, positive, and $2V = 20^\circ$.

Biotite and magnetite are often associated with each other, the later probably separating out from biotite at some stage.

Zircon is reasonably abundant both as small inclusions in larger biotite flakes with accompanying pleochroic halos, and set in the matrix as small elongated grains of rounded outline.

Specimen No. A139/85

Field Name

Siliceous biotite, feldspar gneiss.

Locality

Road cutting, across Delprat cross-section.

Macroscopic

The gneiss is rather feldspathic, with quartz and biotite also abundant. Garnets are small and sparse. Gneissic banding is weak.

Microscopic

The principal minerals are quartz, feldspar and biotite, with subordinate sericite, and accessory magnetite and zircon. The texture is coarsely gneissic, oriented biotite set in a matrix of granulose quartz and feldspar. Sericitisation is pronounced, with a subtle development around outlines of feldspar and quartz grains. Sericite occurs as small leaflets in random orientation. Biotite is present as large brown flakes altering at the edges to sericite. Magnetite inclusions are common in these larger flakes, but occasional magnetite segregations occur outside of the biotite.

Quartz is very abundant, and 50% of the rock is free quartz. It is essentially granular and irregular in shape, and often rimmed by sericite.

Plagioclase grains are rare—approximately 5% of the rock. Xenoblasts are poorly twinned. Extinction angles are low, with a maximum of $+8^{\circ}$ in sections normal to $O10$. The composition is oligoclase. $2V$ is nearly 90° , and the mineral is biaxial, negative. Orthoclase is slightly more abundant, from 5-10%.

Garnets are broken apart, but not badly altered.

Zircon is the only recognisable accessory.

The rock is remarkably even-grained due to granoblastic quartz and feldspars. Xenoblasts have an average diameter of 1mm.

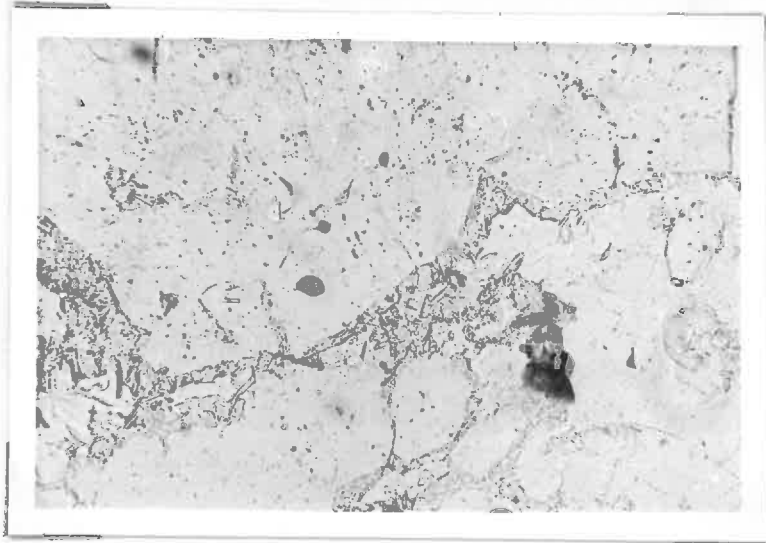

Figure 16 = Hanging Wall Gneiss "B"

The photograph (X70) of A139/85 shows the development of fine-grained sericite at the edges of quartz and feldspar xenoblasts. A large, typically rounded, zircon has been ringed.

3. THE APLITES

(Eighteen thin sections were examined, and ten have been included in this description section).

Specimen No. A139/117

Field Name

Aplitic quartzite.

Location

Diamond drill core near the lode below 10 level,
Delprat area.

Macroscopic

A fine-grained garnet quartzite consisting largely of quartz and minor garnet. The rock has a bleached appearance when dry, but is pinkish when wet. The grain size is so small that only quartz and garnet can be recognised.

Microscopic

A fine-grained quartzite with a marked lineation. Component minerals are quartz, garnet, sillimanite and feldspar, with subordinate biotite and sericite, and accessory zircon. The siliceous matrix is largely granoblastic, although elongation of quartz and feldspar grains is evident. However, there is no sign of any strain in these crystalloblasts. The sillimanite prisms are small and usually occur as individuals, more rarely as bundles of fibres in association with sericite. They exhibit a strong preferred orientation parallel to small flakes of biotite. Most needles are unaltered and idioblastic, although slight sericitisation has occurred in some cases at the edges.

Quartz xenoblasts comprise 65-70% of the rock. The average grain diameter is from $\frac{1}{2}$ - 1 mm. Most grains are clear, and sometimes the grain boundaries are outlined by wisps of sericite. Inclusions of minute grains of sillimanite, sericite, biotite and quartz are numerous in some grains.

Plagioclase and orthoclase present are mostly sericitised. However, feldspar is not abundant, and only 5% of the rock consists of these minerals. Orthoclase is not twinned, and plagioclase poorly twinned. The multiple twinning of the latter can be seen most effectively with the high power objectives. No extinction angles were measured. Plagioclase is biaxial, positive, and 2V is approximately 70°. Grains are xenoblastic and usually rimmed by sericite. Alteration has not, however, reached the stage observed in all orthoclase relics.

Irregular-shaped pink garnets, often aggregated, are of about the same grain as quartz grains. They are in the majority of cases perfectly fresh and unaltered and contain few inclusions. There is no evidence of a fragmented habit, so often observed in larger garnets of Broken Hill vintage.

Biotite is not abundant. It occurs as rudely aligned streaks, and is in most cases completely unaltered. Most flakes are strongly pleochroic from light brown to dark brown with a red ring, and contain small blebs of magnetite. On rare occasions partial chloritisation and sericitisation is apparent.

Specimen No. A139/117 (cont.)

Zircon, apatite and magnetite are rare. The zircons are typically rounded and often quite large. Apatite is plentiful but grains are irregular in shape, and small in size. Magnetite occurs only as the pre-mentioned segregations in larger plates of biotite.

Specimen No. A139/118

Field Name

Epidosite quartzite.

Location

Quartzite in lode below 10 level, Delprat area.

Macroscopic

This is a very good epidosite quartzite. It is a pinkish colour (due to fine-grained garnet), but streaks of epidote-rich material of dark green colour are common. Quartz veins, containing coarse sphalerite and chalcopyrite also occur. These are essentially blue, translucent quartz of large grain size.

Microscopic

The rock is an epidote quartzite with distinct granoblastic texture. Component minerals are quartz, clinozoisite, epidote and garnet, with minor chlorite. 50-60% of the rock is quartz, occurring as polygonal sections less than 1 mm in diameter. A large percentage of the remaining minerals is clinozoisite which abounds as xenoblasts of the same size as the quartz grains. It is non-pleochroic and exhibits characteristic birefringence. Garnets are present, but subordinate to the above mentioned species. They are small, idioblastic, and unaltered. Yellow, pleochroic epidote, usually rounded blebs of high relief are rather sparse.

A notable feature is the absence of any feldspar, coincident with no signs of sericitisation which has been a common phenomenon in rocks close to the lode horizon. Alteration is limited to partial chloritisation of epidote and clinozoisite. Garnets are completely fresh.

Accessory minerals are distinctive and easily recognised. Thus zircon, as rounded grains of high relief and strong birefringence, is relatively abundant. Ilmenite and sphalerite also occur, but are rare.

Specimen No. A139/119

Field Name

Aplite.

Location

D.D. core, Laurel No. 2 Hole.

Macroscopic

A rather non-descript quartzose rock of fine grain size. The rock is deficient in dark minerals, and has a whitish colour flecked pink by minute garnets. Occasional quartz veins cut the rock, but texture is essentially granular and homogeneous.

Microscopic

A rock of granoblastic texture, essentially quartz, feldspar and garnet, with subordinate brown biotite and wisps of sericite. Feldspars are orthoclase and minor well-twinned plagioclase, with no microcline. Zircon and ilmenite are the accessory minerals.

Quartz grains are very irregular in shape, although consistent in size. The average diameter is slightly greater than 0.5 mm, but grains may reach 1 mm. Most feldspar crystalloblasts are somewhat smaller. Quartz xenoblasts frequently contain minute inclusions of indeterminate material. These inclusions are not arranged in any pattern, and do not indicate a pre-existing grain boundary. 65% of the slide is quartz.

Orthoclase is common, and often altered to fine flakes of sericite. No twinning is apparent. Plagioclase is less abundant, but grains are well-twinned on the simple albite law and show no signs of alteration. The composition is that of andesine. 5% of the rock is orthoclase, with plagioclase less than 5%.

Garnets are small and frequently altered at the edges to biotite, chlorite and sericite. Crystalloblasts are badly shaped, and fractured. No inclusions are present, although fractures are commonly filled with wisps of sericite.

Biotite occurs only as small irregular flakes which are pleochroic from light to dark brown. It is not abundant but is evenly distributed throughout the matrix. There is no evidence of any preferred orientation.

Zircon, ilmenite and pyrite are accessories, with pyrite more abundant than the first two.

Specimen No. A139/121

Field Name

Aplite

Location

An aplite from pegmatite development close to the lode on 22 Level, South Mine.

Macroscopic

A grey rock resembling fine-grained pegmatite. Occasional large grey orthoclase crystals occur, but on the whole the rock is of small grain size and rather siliceous. Lineation and elongation of quartz grains is apparent even in hand specimen, and a small biotite content appears as segregations which are strongly directional. Streaks of sericite are abundant, and small pink garnets subordinate.

Microscopic

A fine-grained rock of quartzite composition. Quartz, feldspar and sericite are dominant minerals, with subordinate biotite and a low percentage of feric constituents. Magnetite, ilmenite, and zircon occur, but only in accessory proportions. The texture is strongly directional, with biotite flakes and streaks of sericite showing preferred orientation, and quartz-feldspar grains rather elongated. The average grain size is small, and grain shapes are mostly irregular. Sericite flakes are larger than is usually the case for this retrograde alteration product and flakes are well formed. The shapes of all component minerals suggests growth under directed pressure. Hence the layered appearance.

Plagioclase is xenoblastic, and often rimmed by sericite. Inclusions, largely quartz and minute flakes of biotite, are common. Twinning is coarse and poorly defined. The maximum extinction angle normal to $O10$ is $+15^\circ$, and the mineral is biaxial negative. The composition is sodic, $Ab_7 An_3$, on the oligoclase-andesine border. Myrmekite intergrowth with quartz is common, and several large grains of plagioclase are rimmed with myrmekite 5-10% of the rock is plagioclase, and 60% quartz.

Garnet is rare, but a few fragmented xenoblasts were detected. These are pink and completely unaltered. It is present only in accessory amount. Likewise, orthoclase is rare, and the potash content of the rock must be rather low.

Magnetite and zircon are also accessories, but very rare.

Specimen No. A139/123

Field Name

Aplite.

Location

Surface outcrop at Thackaringa.

Macroscopic

A white, sugary aplite composed mainly of quartz and feldspar. Grains are equidimensional, and the rocks resemble a rather medium to coarse grained metaquartzite. Quartz crystals are clear and colourless, and feldspar is white and slightly weathered in places. A few rare flakes of biotite were observed, but dark minerals of this nature are generally absent. No sulphides were detected, the weathered portions of the rock showing no iron-staining. Blue quartz, often present in other aplites close to the lode, is absent in this rock.

Microscopic

The rock is composed entirely of quartz and feldspar (mainly plagioclase). A few flakes of biotite occur, and zircon and rutile are accessory minerals. The texture is granoblastic, with biotite flakes arranged haphazardly and quartz, feldspar xenoblasts normally equidimensional, and showing no signs of strain.

Quartz grains are very irregular, but are clear, contain few inclusions, and show no signs of sericitisation. No pre-existing grain boundaries are visible. 50-60% of the rock is quartz.

Plagioclase xenoblasts are well-twinned, and completely fresh and unaltered. Extinction angles normal to O10 reach a maximum of $+10^{\circ}$. It is biaxial, negative, with moderate 2V. The composition is oligoclase, nearly $Ab_7 An_3$.

Orthoclase is present, but subordinate to plagioclase. 25-30% of the slide is plagioclase, with less than 10% orthoclase. This mineral is unaltered and not twinned.

Accessory minerals are interesting. Zircon is abundant as small rounded grains of high relief and strong birefringence. Rutile grains are small but often perfect in crystal form. These are brown, of sufficient intensity to mask interference colours. Rutile is unusually abundant.

Chlorite and ilmenite are also present, but fairly rare.

Grain size is on the average 1 mm in diameter.

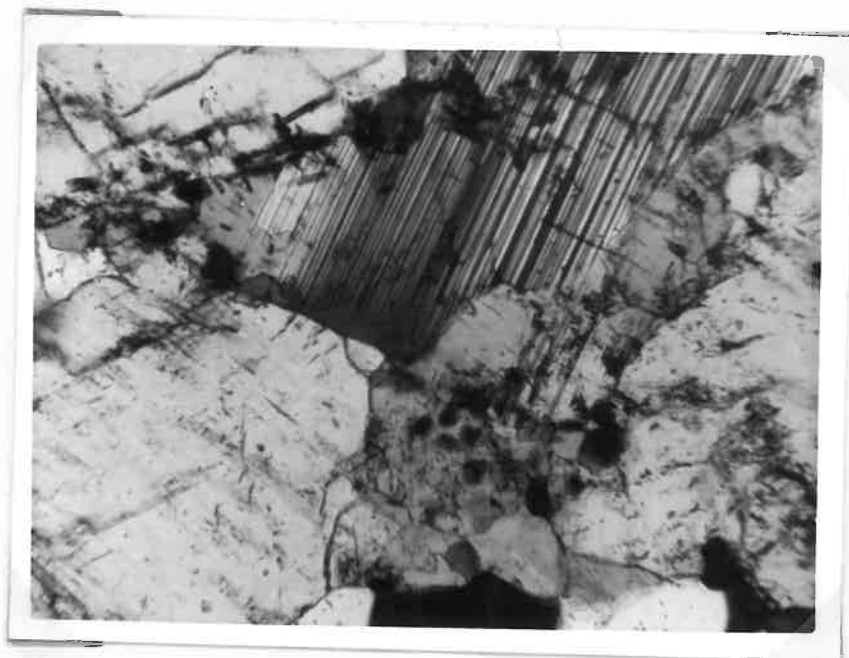

Figure 18 - Aplite

The photograph (X70 approx.) of A139/123 shows the xenoblastic nature of plagioclase and quartz, and the fine multiple twinning of plagioclase in this rock. Small unoriented flakes of biotite also occur.

Specimen No. A139/124

Field Name

Aplite

Location

Pinnacles district

Macroscopic

A medium-grained aplite with faintly gneissic structure. The rock is composed mainly of quartz and feldspar, with subordinate sericite (or muscovite) and a few rare flakes of brown biotite. It has a layered appearance with coarser grains of quartz and feldspar separated by irregular folia of muscovite. Several large crystals of orthoclase occur, but the grain size overall is consistently even. Larger quartz grains are noticeably bluish-grey, a feature of siliceous rocks close to the lode channel, but no sulphides are visible.

Microscopic

The mineralogy is identical to that of A139/123. Thus the rock is largely quartz and oligoclase, with subordinate orthoclase and occasional flakes of biotite. Both zircon and rutile are present in minor amount. The texture, however, differs slightly from the previous rock in that grains of quartz and feldspar are more irregular in shape, and variable in size. An average grain diameter cannot be estimated; all sizes from minute inclusions to xenoblasts several mm wide being present. The rock has suffered no sericitisation and all mineral constituents are fresh.

The plagioclase is twinned on the albite law, rather coarsely. Extinction angles provide a determination of the composition, which is rather sodic; that of oligoclase, $Ab_{70}An_{30}$. Plagioclase grains are xenoblastic, and normally smaller than 1 mm in diameter, commonly about $\frac{1}{2}$ mm. 25-30% of the rock is oligoclase. Orthoclase again is subordinate, to the extent of only 5% of the slide. No other feldspars occur.

Specimen No. A139/125

Field Name

Aplite

Location

Pinnacles district

Macroscopic

A grey speckled aplite composed of fine grains of quartz and feldspar. Minute flakes of biotite, and crystals of pyrite and chalcopyrite occur less abundantly. Coarser grains of feldspar are present as vein-like masses which make more apparent a faint gneissic structure imparted by aligned flakes of biotite. A yellowish staining on weathered surfaces resembles that often associated with the weathering or oxidation of quartz-galena material of the Broken Hill lode. However, no lead or zinc sulphides are visible in the hand specimen.

Microscopic

The rock is composed mainly of quartz and twinned plagioclase, with a small proportion of orthoclase. Sericite is less abundant, and probably retrograde. Pyrite is present in amount greater than accessory, but galena, rutile, and zircon are rarer. The texture is granoblastic, both quartz and plagioclase grains being xenoblastic but approximately equidimensional. No directional texture is evident.

Crystals of plagioclase are rather finely twinned (polysynthetic twinning), and extinction angles measured normal to 010 give a maximum result of 15° . The feldspar is biaxial, positive, with $2V = 85^{\circ}$. It has the composition Ab_6An_{14} , and is andesine. Most grains show little or no signs of alteration. Perhaps 30-40% of the rock is andesine.

Potash feldspar occurs as orthoclase, but no microcline was determined. Slight alteration to sericite wisps is apparent in a number of cases. Orthoclase is subordinate to plagioclase, and an estimate reveals that only 5% of the rock was potash feldspar.

Quartz grains are usually about 1 mm in diameter, but are very irregular in shape. Grain boundaries in many cases are somewhat indistinct 50-60% of the slide is quartz.

Sericitisation is not intense, but occasional wisps can be observed. Few of these are large most being small and poorly-formed. Sericite is a retrograde mineral after feldspar here.

Pyrite, galena, hematite (after pyrite), and zircon are present, but pyrite is the only one of these that is at all abundant. Crystals of pyrite are usually well formed, but rather shapeless aggregates also occur. Of the other minerals mentioned, rutile crystals are small but often idiomorphic and the zircons are typical of most zircons in the granitic rocks of the district - small and rounded in outline.

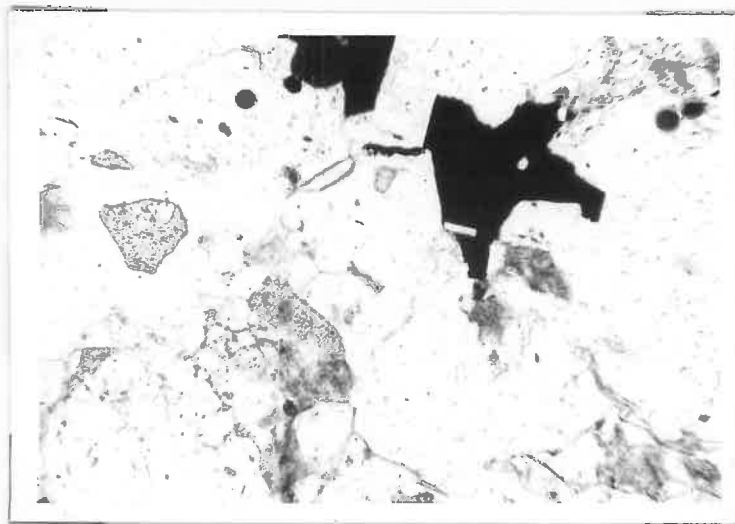

Figure 19 - Aplite

The photograph, (X70 approx.) of A139/125 shows the idiomorphic crystals of pyrite. Feldspar are clouded, due to partial sericitisation. Larger flakes of sericite can also be seen.

Specimen No. A139/126

Field Name

Aplite.

Location

From the Big Hill district.

Macroscopic

A white, siliceous aplite with a weak gneissic structure. The banding is due to veins of feldspar which appear somewhat altered. Pyrite and pyrrhotite are particularly abundant and occur as small individual crystals scattered throughout.

Microscopic

The mineral assemblage is quartz-plagioclase-orthoclase. Subordinate sericite (as felted masses of minute flakes) and pyrite are also present. The texture is granoblastic, although the streaks of sericite give an impression of directional texture. Grains of both quartz and feldspar are equidimensional and certainly not elongated, however. In fact, the growth appears more "metamorphic" than many other rocks of this type, with semi-polygonal grain boundaries indicative of simultaneous recrystallisation. These boundaries are very sharp and clear.

Quartz crystals are clear and unaltered, and contain few inclusions. This mineral is irregular in shape and xenoblastic, but grain diameters are consistent within the range 1 mm to $\frac{1}{2}$ mm.

Plagioclase xenoblasts are approximately the same size as the quartz grains. The soda-calcic feldspars are dominant over potash feldspar as in most of the aplites examined in thin section. Crystals of plagioclase are unaltered and contain few inclusions. Twinning is found and extinction angle measurement gives a maximum for sections normal to 010 of $+15^{\circ}$. The composition is that of andesite, Ab_6An_4 35 % of the slide, was twinned plagioclase, and quartz is slightly more abundant (perhaps 40-50%). Orthoclase has been sericitised, but a few Carlsbad twins were of interest. Less than 10% is orthoclase. No other potash feldspar is present.

Crystals of pyrite, often well-formed, are particularly plentiful. Masses of small quartz grains aggregated together are common in the matrix, but sometimes these surround idioblastic pyrite crystals. Rutile, as rounded grains of high relief, is again present in accessory amount, and magnetite and zircon are less abundant.

Specimen No. A139/128

Field Name

Aplite

Location

Near No. 7 Shaft, South Mine, at 12 Level.

Macroscopic

In the hand specimen this rock would be classified as a quartzite. It is dense and massive, very hard, and extremely fine-grained. A pinkish tinge is undoubtedly due to disseminated garnet. It thus closely resembles the typical lode "garnet quartzites". Biotite is rare, but a few flakes are present, with minute garnets. The grain size is too small to positively identify any feldspar, but this mineral, if present, would be subordinate to quartz and even garnet.

Microscopic

The rock is composed largely of quartz and garnet, with subordinate orthoclase. Biotite, galena, sphalerite, magnetite and ilmenite, biotite and zircon are of less importance. Texture is granoblastic, quartz and feldspar crystals being xenoblastic, and the garnets often idiomorphic. These garnets are rather small, and show no signs of alteration.

Quartz grains are clear, with few inclusions, and outlines are sharp. The mutual relationships certainly point to metamorphic recrystallisation. At least 60% of the rock is quartz. No plagioclase occurs, the only feldspar present being orthoclase, and this mineral is certainly not over-abundant.

Sericite does occur, but is rare here. Ilmenite and sphalerite suggest some affinity with the lode, and galena is also present. Biotite is not plentiful, but groups of tiny magnetite particles may represent completely decomposed biotite.

Zircon occurs in accessory amount. Grains are somewhat elongated, and crystal outlines are blunt and rounded.

The rock has obviously been subjected to infiltration of fluids from the lode channel.

Specimen No. A139/130

Field Name

Aplite.

Location

Outcrop from the Redan district.

Macroscopic

A gneissic aplite composed largely of quartz, feldspar and subordinate biotite. Streaks of irregular and non-continuous biotite folia, separate quartz and feldspar grains, imparting a faintly gneissic structure on the rock as a whole. However, there are no distinct layers of the salics, nor is there pegmatitic veining. An abundance of feldspar is evident. Quartz may comprise over 50% of the rock, and is colourless and clear, and not a translucent blue colour. The rock is slightly pinkish, which may be due to fine-grained, disseminated garnet, not visible as individual crystals in the hand specimen, or to the colour of orthoclase crystals (more likely).

Microscopic

This is a quartz, plagioclase, orthoclase rock with granoblastic texture. Ilmenite, zircon and sericite occur in accessory amount. Magnetite has altered extensively to bright red hematite. No biotite occurs, nor any garnet. Pyrite is relatively abundant.

Quartz grains are irregular, and variable in size. Larger crystals of feldspar and quartz are often separated by aggregates of small quartz grains, very irregular and even angular in shape. Larger quartz crystals are cracked, and undulose extinction suggests strain 45-50% of the slide is quartz.

Plagioclase and orthoclase together are just as abundant as quartz. Plagioclase is perhaps more plentiful than orthoclase. The former exhibits multiple twinning, usually on the simple albite law. However, twinning is frequently coarse, but not always sharp. The maximum extinction angle normal to OLO is $+14^{\circ}$, and the composition is $A_{67}An_{33}$, oligoclase. Orthoclase occurs as clear unaltered grains of low relief, lower than neighbouring quartz and plagioclase grains. Several Carlsbad twins are present in the slide. There is no alteration to sericite.

Magnetite occurs as well-formed crystals, and is usually considerably altered to hematite. Ilmenite has a slightly higher reflectivity; it has changed to sphene or leucoxene at the edges. Small zircons abound, and are characteristically rounded. A few flakes of sericite are of minor interest.

4. ROCK ORIGIN SUITES.

TRANSITION FROM B.I.F. TO GRANITE GNEISS

<u>Thin Section</u>	<u>Description</u>
A139/51	quartz, garnet, magnetite rock
A139/52	quartz, garnet magnetite rock
A139/53	magnetic feldspathic quartzite.
A139/54	Potosi Gneiss "A"

This suite was selected from a length of diamond drill core which showed a good gradation from a garnet-magnetite rich horizon to a feldspathic - garnet granulite (actually Potosi "A"). No sharp contact between these rocks was apparent. The B.I.F. was a dark black, finely-banded rock, with a pink tinge (more noticeable when dry) due to garnet. Garnet and magnetite were the chief constituents, with subsidiary quartz. This rock graded into the feldspathic gneiss by a gradual increase in alkali feldspars and quartz and a decrease in magnetite. All intermediate stages were observed. The rock became richer in biotite which tended to accentuate the banding by adopting a marked preferred orientation, paralleling the strings and seams of garnet and magnetite. There were no signs of garnet changing to biotite in this modification of B.I.F. Silica content had increased, and the grains of quartz became coarser - as though the introduction of mobile material had led to a more pronounced recrystallisation of similar mineral species. A gradual increase in feldspar, notably plagioclase, culminated in the development of a Potosi - like gneiss. This was still rather rich in magnetite even though quartz, plagioclase, garnet and biotite predominated. The colour was normal for a Potosi Gneiss, but a hand magnet was surprisingly strongly attracted. The magnetite here does not occur as streaks parallel to the foliation, but is intimately associated with large garnets and ragged dark brown flakes of biotite.

Specimen No. A139/51

Field Name

Quartz, garnet, magnetite rock, or "Banded Iron Formation".

Location

D.D. hole E2, Delprat core, 423'.

Macroscopic

This is a fine-grained massive garnet, magnetite quartzite with sedimentary relict banding of magnetite. It breaks with an uneven fracture and is very hard and heavy. Small chips are strongly magnetic. Fine-grained garnets give the rock a pink coloration, but it is nearly black when wet. Garnet and magnetite are very abundant, with less quartz.

Microscopic

The chief minerals are garnet, quartz and magnetite and apatite with accessory crystals of pyrite and galena. This rock has a simple granoblastic texture with a tendency for magnetite to occur as long streaks separated by grains of pink garnet, isolated magnetite and quartz. Garnets are equidimensional and completely unaltered. The average grain size of the main minerals is approximately 1 mm.

30% of the slide is garnet - grains which are light pink, completely isotropic and have a high relief. Only 20% of the rock is quartz. This mineral is xenoblastic, and has low relief and weak birefringence. Nearly 50% is magnetite, as small black irregular grains and aggregates of grains. Pyrite and galena are rare. The former is associated with magnetite, and is xenoblastic. It occurs in a mass over 1 mm. wide. Traces of galena, showing high reflectivity, can be seen. No other accessory minerals were determined.

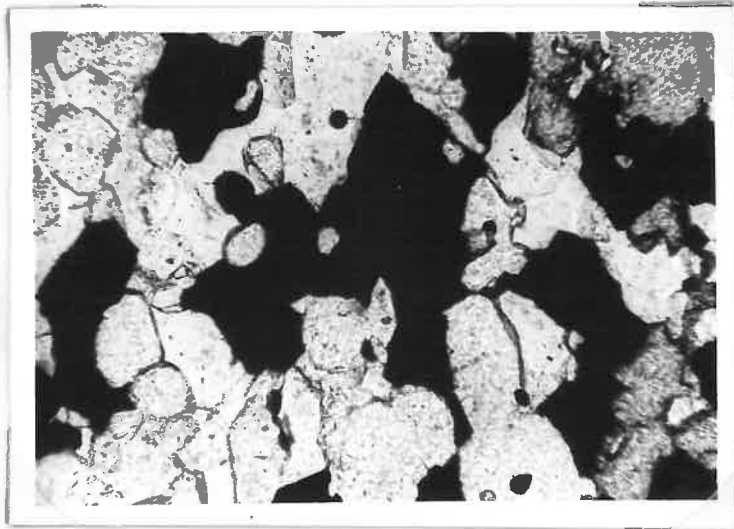

Figure 20 - Quartz, garnet, magnetite rock.

Photograph (Approx. X70). is a thin section of A139/51 showing abundant black magnetite, irregular quartz grains and mottled garnets. Several large crystallo-blasts of apatite of high relief are also present.

Specimen No. A139/52

Field Name

Quartz, garnet, magnetite rock.

Location

D.D. hole E2, Delprat core, 424'

Macroscopic

This rock resembles 51 closely, but banding is more prominent because of a greater percentage of quartz. Segregations of this mineral form distinct layers. The quartz is a deep blue colour, and most grains have outlines of sericite, visible in a polished face. Garnet and magnetite abound.

Microscopic

The rock consists chiefly of quartz, garnet, biotite and magnetite, with subordinate orthoclase, sericite, and traces of pyrite, chlorite, apatite and zircon. Structure is gneissose. Magnetite and garnet grains constitute segregations separated by lenticles of quartz. Some areas have been sericitised and occasional flakes of muscovite were noticed. A minor amount of sericite accompanies garnet. The latter is idioblastic, and partially altered at the edges and in cracks to biotite and chlorite. Some orthoclase is present, but not at all abundant. Plagioclase is entirely absent.

Grain size varies. The average for garnet is $\frac{1}{2}$ mm, but quartz xenoblasts reach 1 mm in width. These are apparently elongated in the direction of a rough foliation. One large quartz mass is $3\frac{1}{2}$ mms. across, and shows pronounced strain shadows or undulose extinction.

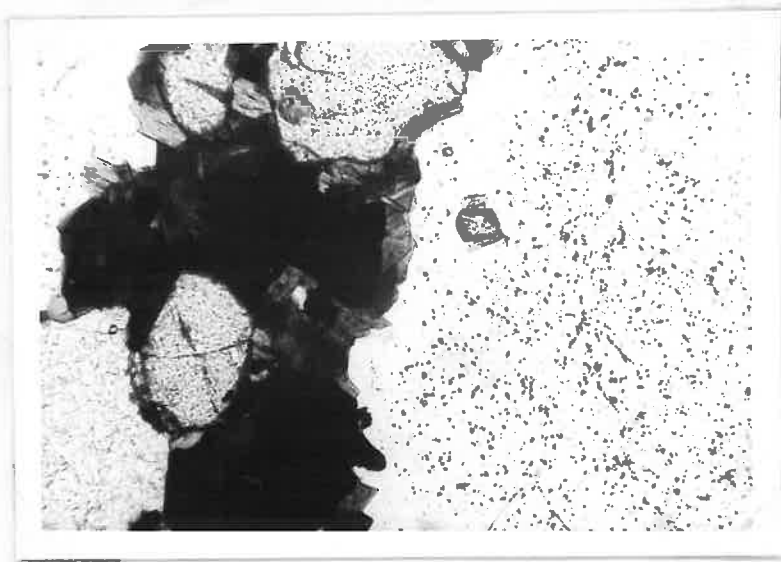

Figure 21 - Quartz, garnet, magnetite rock.

The photograph of A139/52 shows the association of black magnetite, brown biotite, garnet and quartz. The rock is strongly banded and small flakes of semi-aligned biotite are more conspicuous than in A139/51, which is almost devoid of biotite. Garnets are slightly altered marginally to biotite without marked disruption and fragmentation. Minute wisps of biotite are included in larger quartz grains.

Specimen No. A139/53

Field Name

Magnetic feldspathic quartzite.

Location

D.D. hole E2, Delprat core, 425'

Macroscopic

Minerals visible to the naked eye are magnetite, quartz, feldspar, garnet and iron sulphides (possibly pyrrhotite or pyrite). There is no definite gneissic banding, but streaks of magnetite and garnet in a siliceous matrix give the rock a rough parting. Sericite is present, as in A139/52.

Microscopic

The chief mineral components are quartz, sericite, garnet, biotite, plagioclase and magnetite, with accessory pyrite. 30-40% of the rock is quartz, but a large percentage here is sericite. This sericitisation, quite intense, is the main feature of the rock. A gneissose structure is vaguely defined by preferred orientation of the larger biotite aggregates. Over 50% of the slide has been completely sericitised, with the development of fine flakes of muscovite which coarsen in association with larger biotite plates and granular garnets. These garnets are essentially unaltered and occur as definite segregations, all aligned. Magnetite constitutes approximately 5-10% of the thin section.

Plagioclase, poorly twinned, appears for the first time in this suite. It is xenoblastic, and associated with quartz and sericite. Grains showing multiple twinning give a maximum extinction angle of 15° in sections normal to 010 . It is biaxial, negative, and lies in the oligoclase composition range. Orthoclase is absent and has probably changed to sericite.

Grain size is small, especially quartz grains but many grains are larger than 1 mm. Garnets are often $\frac{1}{2}$ mm wide.

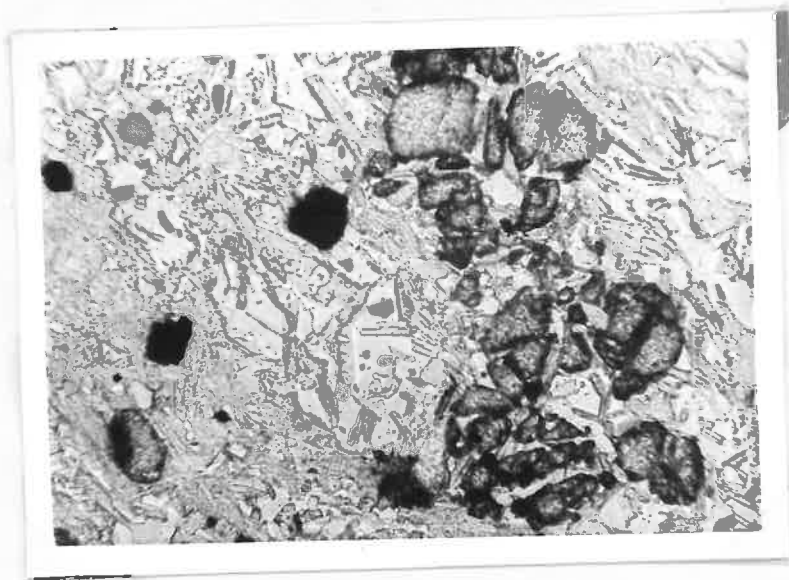

Figure 22 - Magnetic, feldspathic quartzite.

The photograph (X70 Approx.) of A139/53 shows the extensive sericitisation which characterises this rock. Altered garnets and small idiomorphs of magnetite are also conspicuous.

Specimen No. A139/54

Field Name

Garnet, gneiss, slight resemblance to Potosi-Gneiss.

Location

D.D. hole E2, Delprat core, 434^f

Macroscopic

This is a feldspathic rock consisting chiefly of quartz, feldspar, garnet, magnetite and biotite. It is rather granuloze, and is much coarser-grained than earlier members of the suite. Garnets are large and spherical, and rimmed with biotite and magnetite.

Microscopic

This is a quartz, plagioclase, garnet, biotite gneiss, with small garnets imparting on it a speckled appearance. Plagioclase is xenoblastic, usually fresh and unaltered, but sometimes sericitised at the edges and in cracks. Garnets are rounded, and altered marginally to biotite and green chlorite. Magnetite is associated with brown biotite flakes.

Accessory minerals are apatite and zircon. The former is of acicular habit, and fairly abundant.

The chief feldspar is plagioclase. Very little orthoclase is present. Extinction angle normal to $O10$ gives a maximum value of 20° . The composition is that of andesine. It is biaxial, positive.

Grain size is fairly coarse. Garnets have an average width of $1/16''$, and quartz and feldspar crystalloblasts may be several mms in diameter.

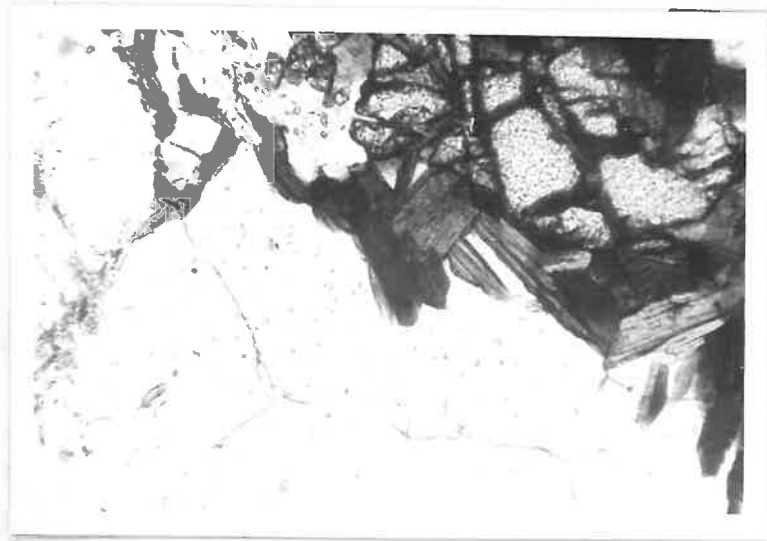

Figure 23 - Granite Gneiss.

Photograph (X70 approx.) of A139/54 shows a large fragmented garnet altered marginally and along fractures to biotite and associated magnetite. Grains of quartz contain numerous small inclusions, irregularly distributed. Sericite has outlined grain boundaries on the left of the photograph.

TRANSITION FROM GRANITIC GNEISS TO AMPHIBOLITE

Thin Section

Description

A139/49b
A139/49c
A139/49a

feldspathic garnet, biotite gneiss.
biotitised feldspar, garnet gneiss.
amphibolite (garnet-rich).

Three slides were cut from a short length of diamond drill core in which a change from granitic vein material to amphibolite was evident. This vein material could not be classified as Hanging wall gneiss or even Potosi Gneiss, but is more of a garnet-rich pegmatite, perhaps resembling Potosi Gneiss in some respects. Segregated quartz-feldspar veins and knotted masses of biotite are characteristic in this rock. Garnets are large and numerous, but always poorly formed and rather dispersed. This material changes imperceptibly into a feldspathic rock rich in biotite, but correspondingly more deficient in garnet. Garnets are still present, but grain diameters are smaller. The amphibolite proper is a rock in which coarsely crystalline hornblende is the dominant mineral. Biotite is still abundant, but feldspar is low, and quartz occurs only as specks and blebs widely spaced. Garnet is not visible in the hand specimen. The latter stages of the change appears to be simply an exchange of biotite and hornblende, until the amphibole reaches a maximum.

The slides are labelled A139/49a, A139/49b, and A139/49c. Actually the order in which they were examined was b, c, and finally a. 49b is largely pegmatitic material, c an intermediate stage in which biotite has become more prominent, and a is a rather fine to medium-grained amphibolite, still containing a relatively high percentage of biotite. Descriptions now follow -

Specimen No. A139/49b

Name

Feldspathic garnet, biotite gneiss.

Location

D.D. hole W1, Broken Hill South Ltd., core, 261'

Macroscopic

The rock is pegmatitic, with abundant feldspar and quartz. However, biotite and garnet are also of some importance. Biotite is knotted, and most flakes are small and of a brownish-black colour. Garnets are large, and bright pink in colour. They are very irregular in shape, and appear dispersed in places.

Microscopic

The thin section can be conveniently divided into three sections:-

1. Quartz, feldspar vein material.
2. Sheared-out or dispersed garnet masses.
3. Biotite-rich gneiss material.

Each of these will be dealt with separately.

1. Quartz, feldspar section.

This is composed largely of porphyroblastic plagioclase and a matrix of quartz and orthoclase. Most plagioclase xenoblasts are cloudy, due to alteration to fine flakes of sericite both at the edges and whenever surfaces were exposed. Quartz grains are equigranular and show polygonal outlines. The texture is granoblastic. Orthoclase is subordinate to plagioclase. The latter is very finely twinned and has the composition of oligoclase. It is biaxial +ve, and $2v$ is nearly 85° .

2. Garnet-rich division.

Large pink isotropic almandine crystals are abundant. These are relatively fresh and occur as segregations associated with a little biotite and crystals of black magnetite. Few inclusions are present in the garnets, apart from isolated round quartz grains and small flakes of biotite. Of some interest is the highly dispersed nature of some garnets. What appears to be a single garnet in the hand specimen is in fact a mass of minute crystals, never well formed and seemingly fragmented.

3. Biotite gneiss portion.

Small, randomly distributed flakes of biotite in a quartz-orthoclase matrix are common, marginal to vein material. This is a biotite, quartz, plagioclase schist. Biotite flakes show a strong preferred orientation. The plagioclase is andesine, Ab_6An_4 . Magnetite is abundant, and apatite, zircon are accessory.

Specimen No. A139/49c

Field Name

Biotitised feldspathic garnet gneiss.

Location

D. D. hole W1, Broken Hill South Ltd., 261'

Macroscopic

Hand specimens at this stage represent a biotite-rich garnet gneiss. The biotite is a black variety, with a slightly greenish tinge. A139/49b contains knots of this biotite. In 49c schistosity is more apparent, and folia of fine-grained biotite are interlayered with quartz and feldspar. Garnets are visible in the more vein-like material, but not large enough to be seen in the biotite schist. The structure suggests a pegmatization of a rock rich in biotite, and where the quartz-feldspar veins have disrupted and partially destroyed the local biotite banding.

Microscopic

The main part of this slide is biotite schist. Chief mineral components are biotite, plagioclase, orthoclase and quartz, with subordinate magnetite. Zircon and apatite are accessory. Schistosity is strong, with flakes of biotite showing a preferred orientation. No amphiboles were determined.

Grain size is fairly uniform, and most quartz crystals are less than $\frac{1}{2}$ mm in width. Biotite flakes are likewise small. Plagioclase, which is more abundant than orthoclase is well-twinned. It has the composition Ab_6An_4 , andesine, with a maximum extinction angle normal to O10 of $+20^\circ$. Alteration of these grains is but slight.

The difference between 49b and 49c is largely a matter of grain size and biotite content. Garnets are large and have very irregular crystal outlines in the more pegmatitic portions. This mineral does not abound in the biotite schist, and when present is quite fine-grained. Crystals are completely unaltered, contain no inclusions, and are well-formed. Accessory minerals are much the same viz. magnetite, zircon and apatite. However, magnetite is more plentiful in the biotite-rich material. Feldspars are the same, and present in approximately the same proportions. Of course the pegmatitic material is considerably richer in these than the biotite schist into which it grades.

Specimen No. A139/49a

Field Name

Amphibolite

Location

D.D. hole W1, Broken Hill Ltd. core, 261'

Macroscopic

A dark green rock in which crystals of amphibole (possibly hornblende), biotite and quartz-feldspar are easily discernible. A schistosity has been retained, with folia of biotite-rich portions and elongated crystals of amphibole sometimes streaked with feldspar segregations. No garnet is visible, and the mineralogy is apparently simple.

Microscopic

The dominant minerals are hornblende, biotite, quartz and orthoclase, with subordinate garnet and magnetite, and accessory zircon. Plagioclase is practically absent. The texture is directional, biotite flakes exhibiting preferred orientation, and hornblende crystals lying with prism faces parallel to the trends of biotite.

Quartz and feldspar grains, with a combined percentage of less than 10% of the rock, are characteristically xenoblastic. Most of the feldspar is orthoclase. This is relatively unaltered, and contains few inclusions. Crystals are less than 0.5 mm in width. Plagio is untwinned, but only a few grains occur. Quartz xenoblasts are more abundant than feldspar. These contain small inclusions of hornblende and biotite and are somewhat polygonal in outline, testifying to a metamorphic recrystallisation.

The hornblende appears as rather ragged blue-green crystals, occasionally yellow-brown. The brown patches grade into blues and greens. Zircons, which are numerous in the biotite also occur within hornblende plates. Biotite has apparently changed to hornblende. This change has not been complete, and relic fabrics are plentiful. Associated with hornblende xenoblasts are small idiomorphs of pink almandine garnets. These are very clear and unaltered. Magnetite is also abundant, and zircon slightly lesser in amount.

TRANSITION FROM "POTOBOLITE" TO AMPHIBOLITE

Thin Section

Description

A139/33
A139/34
A139/35
A139/36

"Potobolite"
feldspathic amphibolite
amphibolite
amphibolite

"Potobolite" is a granulose rock resembling Potosi Gneiss, but distinctive in that development of hornblende has imparted a green colour to it. Biotite, abundant in Potosi Gneiss, is subordinate here to quartz, hornblende, garnet and feldspars. Potobolite is often associated with dark green amphibolite in the lode area. It has only developed at the contact of a feldspathic rock (Potosi Gneiss) and amphibolite, and probably represents a gentle metasomatic exchange of materials across the contact. The amphibolite in this suite is a rock consisting chiefly of hornblende, plagioclase and minor quartz, with occasional small well-formed garnets. All transitional stages were observed in the length of core from which the specimens were selected. The following slide descriptions are representative of this gradation.

Specimen No. A139/33

Field Name

Potobolite

Location

D.D. hole E3, Delprat, 642'

Macroscopic

A granulose rock consisting of garnet, feldspar, quartz, hornblende and biotite. The structure shows no trace of foliation, although a slight lineation of hornblende crystals is apparent. In general, the rock could be described as a hornblende-rich, biotite-deficient garnetiferous pegmatite. Large crystals of feldspar, possibly plagioclase, and visible to the naked eye. Grain size is large, especially garnet, quartz and feldspar. The garnets, completely unchanged at the edges, and poorly formed but often $\frac{3}{8}$ " in diameter. Several large streaks of sphalerite are visible in places.

Microscopic

Chief mineral components are quartz, hornblende, plagioclase and garnet, with subordinate biotite and magnetite, and accessory zircon, sphalerite, pyrite and apatite. The rock is coarse-grained, and essentially granoblastic. Polygonal quartz outlines typify metamorphic recrystallisation.

Plagioclase xenoblasts are often quite large (several mms). Twinning is coarse and sharp, and the composition lies in the highly calcic labradorite range. Orthoclase does not occur. In fact, potash feldspar is completely absent.

Hornblende, very abundant, has a characteristic greenish-blue colour, and is strongly pleochroic. It is intimately associated with minor biotite and magnetite. Larger magnetite masses are commonly rimmed with haloes of garnet. These are very small, and occur as connected aggregates. Large idioblasts of almandine are also of importance. No alteration is evident.

Zircon inclusions are common in the hornblende. These crystals are ringed by characteristic pleochroic haloes. Apatite and magnetite are also readily determined.

Specimen No. A139/34

Field Name

Feldspathised amphibolite.

Location

D.D. hole E 3, Delprat 648'

Macroscopic

The rock is a granoblastic aggregate of quartz, feldspar, and hornblende. Quartz and feldspar together comprise 45% of the rock, with the remainder largely coarse-grained hornblende. No garnet or biotite is visible to the naked eye. A coarse, rather irregular and disconnected banding is evident. Sphalerite and iron sulphides are fairly common.

Microscopic

The rock is similar to A139/33 in actual mineral composition, although proportions of the chief minerals vary considerably. In addition, epidote is fairly plentiful in this rock, but absent in 33. Plagioclase, hornblende, quartz, epidote, garnet and zircon all occur. Quartz is rare, with plagioclase the dominant white mineral. This appears as large xenoblasts, generally showing a coarse multiple twinning. It is labradorite, having a maximum extinction angle in sections normal to O10 of 35° . Epidote is an associate. This mineral is biaxial, negative, with $2V = 70^\circ$. Relief is high, and pleochroism from yellow to yellow-green rather weak.

Garnet, almandine in composition, is not abundant. Grain size has become quite small. Few garnets are large enough to be visible to the naked eye.

Zircon is accessory, usually as inclusions in hornblende crystals.

The main differences between this slide and A139/33 are that garnet content has decreased markedly, and so has the percentage of quartz and feldspar (coincident with a less "veined" appearance).

Specimen No. A139/35

Field Name

Amphibolite

Location

D.D. hole E3, Delprat, 656'

Macroscopic

A rather granular massive amphibolite, consisting largely of feldspar and hornblende. A faint directional texture is evident. The feldspar content is lower than in A139/34, and hornblende correspondingly higher. Garnet is not visible in the hand specimen.

Microscopic

This is a coarse-grained amphibolite with a high percentage of plagioclase. However, hornblende is the dominant mineral and is strongly pleochroic from blue to green. Plagioclase and quartz xenoblasts of common. The former exhibits a coarse multiple twinning and has a low extinction angle of $+15^{\circ}$ for sections normal to 010 (maximum value chosen). The composition lies in the andesine range. It is optically negative and $2V = 85^{\circ}$. Quartz is relatively rare, but a few grains were present.

Magnetite abounds, and this mineral is often rimmed by garnet, or hornblende. Epidote occurs as two forms. Larger xenoblasts are dominant, but small, prismatic idiomorphs are also present. Garnet is rare, but a few idiomorphs were determined.

Both apatite and zircon are accessories. Biotite is rare, and has apparently changed to hornblende.

Specimen No. A139/36

Field Name

Amphibolite.

Location

D.D. hole, E3, Delprat, 669'

Macroscopic

A coarse-grained, massive amphibolite. Hornblende comprises 80% of the rock, with plagioclase a large percentage of the remaining 20%. Banding has almost completely disappeared, and feldspar veining is absent.

Microscopic

This is a coarse-grained amphibolite composed largely of hornblende and plagioclase. Quartz is present, but not abundant. The texture is granoblastic, due to idiomorphs of hornblende and xenoblastic plagioclase. The plagioclase has the composition of andesine Ab_6An_{14} , with a maximum extinction angle normal to Ol_0 of 20° . It is very well twinned. Magnetite or ilmenite is abundant, and pyrite crystals are present sparsely. Epidote is present, but does not reach any great development.

Plagioclase is slightly altered, possibly to sericite or clay. The fine alteration product is indeterminate. Biotite is altering to hornblende.

Accessory minerals are very sparse, but apatite occurs as small rounded grains of moderate relief.

CONTACT BETWEEN SERICITE SCHIST AND AMPHIBOLITE.

<u>Thin Section</u>	<u>Description</u>
A139/41	sericite schist.
A139/42	garnet, sericite schist
A139/43	garnet, sericite schist
A139/44	sericite schist.
A139/45	feldspathic sericite, biotite gneiss.
A139/46	feldspar, biotite gneiss
A139/47	feldspathic garnet, biotite gneiss.
A139/48	biotite-rich "amphibolite".

This transition was of interest on several counts:-

1. As a contact between a banded, strongly foliated amphibolite and sericite schist.
2. The nature of sericite schist and variants of this rock type was studied in close detail.
3. Development of feldspathic and siliceous layers, often coarsely gneissic, in these schists was of some significance as regards mobility of material during metamorphism.
4. A foliated, biotite-rich amphibolite was examined.

Rock slide descriptions follow =

Specimen No. A139/41

Field Name

Sericite schist.

Location

D.D. hole E2, Delprat, 712'

Macroscopic

A highly schistose rock composed of fine-grained sericite interlayered with sheets of quartz-feldspar. Biotite is also present, although not to the same extent as sericite. Again, the flakes are very small. Pink garnets, probably almandine, are disseminated between planes of schistosity. These are somewhat elongate, and usually fragmented with irregular outlines. Grain diameters vary, but the maximum would be less than $\frac{1}{8}$ " , with most about $\frac{1}{16}$ ". Quartz and feldspar layers are contorted, and the structure is suggestive of ptygmatic folding. An estimate of the percentage quartz is difficult, but it would be fairly low - perhaps 30%. No large grains occur. The same applies to feldspar.

Microscopic

The rock is a sericite, garnet, quartz schist, with a conspicuous foliation mainly due to, aligned flakes of fine-grained muscovite (sericite) and subordinate biotite. Quartz xenoblasts are characteristically elongated or sheared-out along the plane of foliation. A fine layering is apparent, with streaks of interlocked sericite flakes separated by trains of polygonal quartz grains. Large almandine porphyroblasts are abundant. These have altered marginally to biotite, and a minor development of small blebs of magnetite, closely associated with the biotite. Magnetite is an abundant constituent throughout; also, small segregations may occur. Fine elongated splinters follow the trend of micas.

Feldspars are of little importance. Plagioclase is present as xenoblasts of about the same size as the quartz (2 mm commonly). It is a rare constituent. Grains are unaltered and coarsely twinned. Twinning, however, is not at all clear. The composition is that of andesine. Orthoclase is entirely absent, and no potash feldspar of any nature was determined. All of the potash of the rock is held by sericite and biotite.

Quartz grains are of irregular shape, usually elongated or flattened. Inclusions, too small to be determined, are plentiful in some areas, but not consistently present. Overall grain size is small, but most grains are 0.2 mms wide, with larger ones less abundant.

Garnets may be several mms wide. These contain inclusions of quartz grains, swept into the nucleus during rapid growth. Alteration has occurred, but is not intense. Segregations of small garnets along schistosity planes are common. These minute grains, frequently disconnected, are completely fresh and unaltered.

Biotite flakes are small, and strongly pleochroic from yellow to brown. They are of the same dimensions as flakes of

Specimen No. A139/41 (cont.)

sericite, the dominant species of this schist. Preferred orientation is pronounced. Zircon inclusions are very small, but high relief and strong birefringence provide an easy basis for recognition. Chlorite, showing anomalous interference colours is an associated of biotite, probably as a retrograde alteration of the latter.

Specimen No. A139/42

Field Name

Garnet, sericite, schist.

Location

D.D. hole E2, Delprat, 704*

Macroscopic

Essential minerals are sericite, garnet, biotite quartz, and possibly chlorite. Structure is schistose, with large pink garnets pushing aside folia of sericite, and to a lesser extent, biotite. Quartz layers are sufficiently fine to be largely invisible to the naked eye. Feldspars cannot be identified in the hand specimen. Almandine garnets are somewhat larger than those of A139/41. Grain diameters of $\frac{1}{4}$ " or more are common. Shapes are still irregular, and quartz inclusions in larger grains are visible in the hand specimen without the aid of a lens.

Microscopic

The only differences of note between A139/41 and this section are that 42 contains more green chlorite, and the grain size, including garnet porphyroblasts, has increased. In addition, the relative proportion of sericite to biotite has increased slightly. Banding, caused by interlocked crystals of sericite, is very apparent. These layers are separated by a matrix of quartz, biotite and minor sericite. Preferred orientation is characteristic of all flakes of mica. Quartz grains are elongated in the plane of foliation. Magnetite, chlorite, pyrite and zircon are of less importance. Feldspars are entirely absent.

Magnetite grains are splinting. Few well-proportioned crystals are present, and segregations of rounded grains are the rule. Pyrite is an associate mineral. Zircon seems to occur only as inclusions in biotite and chlorite. Pleochroic haloes surround each grain.

Grain size is again small, just slightly larger than A139/41.

Specimen No. A139/43

Field Name

Garnet, sericite schist.

Location

D.D. hole E2, Delprat, 701'

Macroscopic

Siliceous banding on a fine scale is characteristic of this specimen. It is largely composed of sericite, chlorite, biotite, quartz and garnet. Schistosity is due to folia of sericite and minor biotite and chlorite. Chlorite has imparted a greenish tinge on the schist. Garnets are numerous and appear sericitised. Growth has been irregular, and most garnets are distorted and elongate.

Microscopic

On thin section this rock shows a gentle gradation from A139/41. Foliation is again strong, but layers of quartz, and subordinate, poorly-twinned plagioclase are more pronounced. Chlorite content has increased, and biotite less abundant. Flakes and grains of chlorite are larger than the average plate of sericite or biotite. The mineral is easily recognised because of a purplish interference colour. This, together with a light green to dark green pleochroism, is distinctive. Tiny magnetite inclusions have accumulated inside the margins of these ragged flakes.

The grain size of garnet porphyroblasts varies from approximately $1/16$ " to $1/4$ ". These are xenoblastic, and unaltered. The larger grains contain quartz grain inclusions. Smaller crystals are remarkably free of inclusions, but still of irregular shape.

Multiple twinning of plagioclase xenoblasts makes determination of this mineral fairly simple. Twinning is coarse, but not sharp. Plagioclase has the composition of oligoclase. Orthoclase is rare, and no crystals were definitely identified.

Zircon and magnetite are accessory, the former as inclusions in larger chlorite flakes. An occasional grain may be found in the siliceous matrix. These crystals are elongate and show no sharp edges. Relief and birefringence is characteristic.

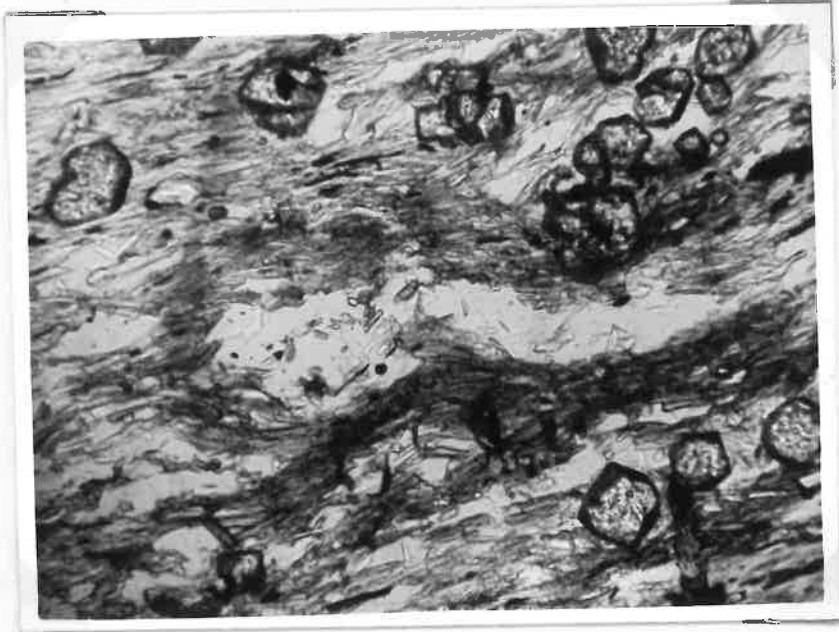

Figure 24 - Garnet, sericite schist.

The schistose structure of A139/43, caused by folia of sericite and subordinate aligned biotite is apparent from the photograph. Small, but perfectly formed garnets have sprouted from the matrix. The magnification is X70.

Specimen No. A139/44

Field Name.

Sericite schist.

Location

D.D. hole E2, Delprat, 686'

Macroscopic

The rock is well-banded, and has a streaky appearance, with distinct layers of quartzose material and folia of micas, mainly sericite and biotite. In parts the texture is almost massive, resembling banded quartzite. If a polished face is wet, bands of finely disseminated garnet are obvious. These layers parallel the general schistosity planes. Several wide quartz veins, again parallel to the foliation, are partially contorted, resembling ptigmatic folding. The percentage of quartz is undoubtedly higher than in earlier slides of this suite. Overall garnet content is hard to compare because of the disseminated occurrence here. Feldspars may be present, but grains are too small to identify with the naked eye or hand lens.

Microscopic

A garnet, sericite, quartz schist. The banded nature is apparent in thin section. Layers of quartz often composed of quite large grains, are separated by streaks of sericite and biotite. Garnet, as almandine, is very abundant throughout. Most grains are small and idioblastic, and slightly altered at the edges to biotite and chlorite. Biotite, subordinate to sericite, is normally brown, but many flakes have a greenish tinge. There is an interesting development of epidote. This mineral is fairly abundant, and often associated with garnet and chlorite.

Quartz grains are irregular in shape, and in wide bands may be 1 mm wide. Inclusions of biotite and other indeterminate material are numerous. However, no pattern in arrangement of these particles was observed. Approximately 35% of the rock is quartz. Feldspars are completely absent. The Ca of the rock would be incorporated in epidote, and potash in sericite and biotite.

Zircon, apatite and magnetite are accessory minerals. Magnetite is the most abundant of these, and apatite quite rare. Zircon is an associate of biotite and less frequently, chlorite.

Specimen No. A139/45

Field Name

Feldspathic sericite, biotite gneiss.

Location

D.D. hole E2, Delprat, 681'

Macroscopic

The rock consists of folia of fine-grained biotite, sericite and possibly chlorite, separated by wide veins of quartz-feldspathic material often $\frac{1}{2}$ " wide. Garnet is abundant, but few large grains are visible. It is pink, probably almandine, and usually confined to layers of biotite, sericite-rich material. Feldspathic veins contain no garnets. Biotite folia are wrapped around an occasional large garnet in the more schistose bands. Biotite is apparently more abundant than sericite. The latter occurs as knotted aggregates in the quartz-feldspar veins.

Microscopic

Plagioclase, with quartz, sericite, garnet and biotite are dominant minerals. Coarse bands of even-grained quartz xenoblasts are separated by a granular mass of fine-grained quartz and plagioclase, with subordinate orthoclase. These layers are separated by streaks of sericite and biotite. Sericite occurs both as large and small streaks, intimately associated with biotite, and as an alteration product of feldspars. Only relics of orthoclase are left, but plagioclase alteration has only been partial. Sericite, as an alteration product, is very fine-grained, and occurs as ragged flakes randomly oriented.

20-30% of the rock is quartz. Xenoblasts are variable in size. Larger grains show undulose extinction due to strain. Outlines are very irregular. Plagioclase has the composition of andesine. It is biaxial, negative, with $2V = 85^\circ$. Multiple twinning is coarse, and sharply defined.

The larger garnet crystalloblasts have altered slightly to biotite and chlorite. Biotite is itself changing somewhat to chlorite. Garnets are characteristically fragmented and disseminated. Compared with earlier thin sections of this suite, biotite, and chlorite content has decreased.

Accessory minerals are magnetite and zircon. The former is often associated with biotite flakes.



Figure 25 - Sericite, biotite gneiss.

The photograph X70, A139/45, shows an alteration of folia of biotite-sericite and quartz. A preferred orientation of micas is very noticeable.

Specimen A139/46

Field Name

Feldspar, biotite gneiss.

Location

D.D. hole E2, Delprat, 679'

Macroscopic

The rock has a speckled appearance, with a very coarse banding. Feldspar, quartz, biotite and sericite are dominant minerals. Structure is particularly hard to describe. Irregular grains of feldspar, in masses up to $\frac{1}{2}$ " wide are bordered by knots of biotite and sericite. Feldspathisation has been very irregular. Layers of finer-grained gneissic material, dominantly biotite, sericite and quartz-feldspar are separated from the coarse-grained material by thin bands of green-black biotite. Chlorite may be present, but is not abundant.. Garnet is apparently absent.

Microscopic

This is a coarsely-banded sericite, biotite, feldspar gneiss. Streaks of sericite, sometimes consisting of quite large flakes, together with oriented brown biotite crystals are set in a matrix of elongated quartz and plagioclase. Myrmekitic intergrowth between quartz and plagioclase is common. An unusually large percentage of the slide is myrmekite.

Quartz abounds, to the extent of 50% of the thin section. Grains are usually xenoblastic, or as intergrowths with plagioclase. The latter is also xenoblastic, grains commonly slightly larger than neighbouring quartz crystals. Multiple twinning is not sharp. The mineral is andesine. It is biaxial, negative, and has a high 2V.

Biotite content has increased compared with previous slides. Sericite has decreased. Chlorite is not abundant, but a few rare flakes were observed. Sericite flakes are often quite large, and in some cases cut across the foliation.

No garnet is present, and accessory minerals are hard to find. Magnetite is the only one of importance.

Specimen No. A139/47

Field Name

Feldspathic garnet, biotite gneiss.

Location

D.D. hole E2, Delprat 678'

Macroscopic

This is a rock rich in biotite, but with a poor foliation because of a rather granulose matrix of quartz and feldspar. Pegmatitic veining, in which large garnets have grown, parallels the schistosity planes. Garnet (almandine) is not abundant, but those present are very large. Sericite is subordinate to biotite, and no chlorite is visible in the hand specimen. Grain size overall is small, apart from the coarser feldspar-quartz-garnet veins.

Microscopic

The rock is a biotite, plagioclase gneiss, with abundant quartz-feldspar veining. Large garnets, nearly $\frac{1}{2}$ " in diameter occur in the feldspathic vein material. Sericite is nearly absent, and an abnormal development of biotite occurs as knotted masses. Plagioclase forms intimate intergrowths with quartz (myrmekite), but large porphyroblasts are also present. Other crystals frequently contain inclusions of rounded quartz grains and ragged wisps of brown biotite. The composition is that of andesine, with a maximum extinction angle of $+18^\circ$, normal to $O10$. Optic sign varies, but $2V$ is very high.

Chlorite and magnetite are not plentiful; chlorite appearing only as occasional scattered flakes with slight pleochroism from colourless to green. A feature of the chlorite is the purple interference colours, consistent in all slides in which the mineral has occurred.

Garnets, only large porphyroblasts, are rare. Sericitisation has been slight, and chlorite, biotite are also alteration products. Biotite rimming in a rock very rich in biotite is absent.

Specimen No. A139/48

Field Name

Biotite-rich amphibolite.

Location

D.D. hole E2, Delprat 677'

Macroscopic

A schistose rock consisting mainly of fine-grained biotite, feldspar, quartz, garnet and hornblende. Feldspar veining is less apparent, and layers are fairly thin.

Microscopic

This rock is a biotite, hornblende, quartz schist. It probably represents the onset of amphibolite development. Feldspar is deficient, and garnets are small and of the order 1/16" in diameter. Biotite is strongly pleochroic from yellow to brown, and flakes are oriented to impart on the rock a coarse foliation. Hornblende occurs as small idiomorphs of high relief and exhibits a strongly blue-green to yellow-green pleochroism. However it is relatively rare.

Magnetite and zircon are the main accessories. However both pyrite and galena also appear.

Of course the main difference between 48 and earlier slides lies in an increased biotite content, in deficiency of feldspar, and the first appearance of hornblende.

TRANSITION FROM SERICITE SCHIST TO AMPHIBOLITE

<u>Thin Section</u>	<u>Description</u>
A139/59	sericite schist.
A139/60	feldspathic sericite schist.
A139/61	biotite, sericite schist.
A139/62	fine-grained amphibolite.
A139/63	coarse-grained amphibolite.

The contact between sericite schist and coarse, massive amphibolite was studied microscopically. The sericite schist is fine-grained and consists largely of white mica and quartz. The biotite content of this suite increases gradually, but most of the iron becomes incorporated in dark green hornblende in the upper members. The amphibolite in this case is granulose, with no apparent banding in A139/63. A139/62 contains streaks of quite material (quartz and feldspars), but the banding is very irregular and disconnected. The suite was of significance in that sericitisation could be studied in contact with a completely unaltered amphibolite.

Specimen No. A139/59

Field Name

Sericite schist.

Location

D.D. hole 832, North Broken Hill Ltd., core, 240'

Macroscopic

This is a banded rock consisting of quartz and feldspar layers between folia of sericite, and to a lesser extent, biotite. Cleavages along planes of foliation show these micaceous layers. The rock has a silky sheen in the hand specimen. Oriented sericite is speckled with small aggregates of biotite and patches of quartz and feldspar. No garnets are visible in the feldspathic portions, but stretched-out pink almandine crystals occur between folia of sericite and biotite. These are not at all obvious.

Microscopic

The rock consists of a granoblastic matrix of quartz, orthoclase (rare), and plagioclase. Streaks of sericite, with a strong preferred orientation, impart a foliation to the rock. Important minerals present are quartz, sericite, plagioclase, and biotite, with a minor occurrence of orthoclase, magnetite and zircon. All of the chief components are xenoblastic. Quartz grains are small; less than 0.5 mms wide. At least 50% of the rock is quartz. These crystals contain numerous inclusions. Boundaries are irregular but sharp and non-sericitised.

Plagioclase xenoblasts exhibit multiple twinning. This is fairly coarse, but not always sharp. Grains are very clear and perfectly fresh. The composition is $Ab_{70}An_{30}$, that of oligoclase. 5% of the rock is plagioclase. Orthoclase is fairly rare, and only a few grains were positively identified as such. Other feldspars, such as microcline, do not occur.

Sericite is abundant as small flakes of medium relief showing preferred orientation about 30% of the rock consists of this mineral. The smaller flakes are quite well-formed, but larger ones tend to be ragged. Biotite is less abundant, and is of a yellow-brown colour, with no reddish tinge. It is strongly pleochroic, and often associated with small crystals of magnetite and ilmenite.

Zircon is accessory, but grains are easily determined. They are very small, and usually elongated and rounded at the corners and edges.

Specimen No. A139/60

Field Name

Sericite schist, rather feldspathic

Location

D. D. hole 831, North Broken Hill core, 240'

Macroscopic

This is a strongly banded rock, which could be satisfactorily classified as a sericite, biotite, feldspar gneiss. Foliation of closely associated sericite and biotite are sandwiched between layers of feldspar and quartz. These often contain large grains of quartz which have been elongated along the schistosity planes. The layers of sericite are in many cases extremely contorted, resembling tectonic folding on a very minor scale. Schistosity parallel sericite layers parallel these white streaks. Garnet is again present as sheared-out, sericitised and fragmented aggregates. The pink colour is masked to some extent by sericitisation. Blue quartz grains suggest some connection with the lode.

Microscopic

Mineralogy and textures resemble those of 4139/59, with a few exceptions. Banding and distinct layering is more noticeable. This was evident from the hand specimen. Biotite content has increased slightly. This also applies to plagioclase and garnet. Quartz grains are larger and show undulose extinction in some instances. The rock has been subject to stress.

Specimen No. A139/61

Field Name

Biotite, sericite schist.

Location

D.D. hole 832, North Mine core, 240'

Macroscopic

Hornblende and biotite are the dominant minerals in this schist. Quartz, orthoclase, sericite and subordinate pink almandine are also noteworthy. The structure is schistose, with folia of biotite and prisms of hornblende lying along planes of schistosity. Sericite is not abundant, and does not contribute greatly to the banding. Quartzose layers are not numerous. These have a light pink colour especially noticeable when wet, and resemble garnet sandstone in miniature. The garnetiferous nature was verified by an examination of the thin section.

Microscopic

The rock still retains a strong foliation, but sericite is practically absent. The main minerals present are biotite, hornblende, quartz, garnet, orthoclase and plagioclase. Hornblende is elongated in the plane of foliation, long axes paralleling cleavages of biotite, which likewise shows a powerful preferred orientation. These minerals are always intimately associated, and biotite appears to be altering to hornblende. Aggregates of pink almandine form long streaks along the plane of schistosity. These crystals are associated with polygonal plates of quartz and an occasional xenoblast of plagioclase. They are very small, and often perfectly idioblastic. No alteration is apparent, and inclusions are absent.

Larger hornblende crystals contain small inclusions of zircon, with surrounding pleochroic haloes. Pleochroism is very strong, from yellowish brown to bluish green as extremes. Hornblende is intimately associated with biotite and small grains of magnetite. Biotite is brown, with no reddish tint, and has partially altered to hornblende.

Plagioclase is rare, but an occasional large xenoblast occurs. It shows multiple twinning on the albite law. This is fairly coarse and frequently sharp. The composition is oligoclase, and it is bi-axial, negative and has a high 2V. No alteration is apparent and grain outlines between plagioclase and quartz are sharp. Orthoclase grains contain small inclusions of indeterminate nature. However, alteration has not occurred to any extent. This feldspar is present to the same proportions as plagioclase.

Magnetite and pyrite are fairly abundant; the former more so than the latter. Magnetite forms small aggregates and individual grains showing no crystal outlines. Pyrite is usually crystalline. Zircon is a constant accessory, and apatite somewhat rarer.

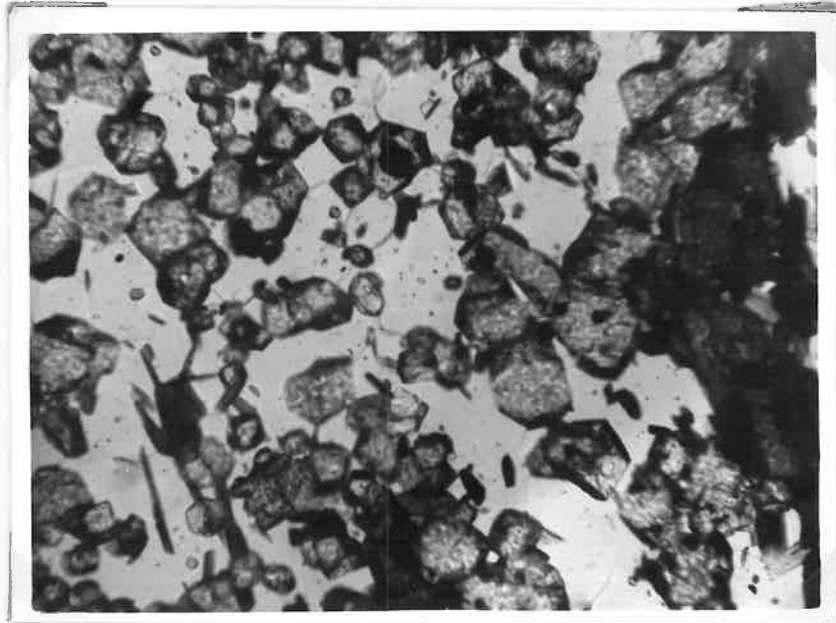

Figure 26 - Biotite, sericite schist.

The photograph X70 shows aggregates of idiomorphic garnets which occur as long seams parallel to the plane of schistosity. The darker mineral is biotite and the lighter mainly quartz. The specimen is A139/61.

Specimen No. A139/62

Field Name

Fine-grained amphibolite

Location

D.D. hole 832, North Mine core, 240'

Macroscopic

The mineralogy appears to be relatively simple. Hornblende predominates, but there are streaks of white quartz-feldspar which suggest a retention of a relict bedding. No biotite is present, and garnet, if it does occur, is too fine-grained to be visible to the naked eye. Directional texture is still of some importance.

Microscopic

The amphibolite is composed of hornblende (perhaps 70%), quartz, magnetite, and subordinate orthoclase. Plagioclase xenoblasts are rare, as are small garnets. Zircon is remarkably abundant for an accessory. The rock shows an obvious lineation in thin section, with aligned elongate xenoblasts of hornblende and thin lenses of quartz and minor feldspar.

Hornblende is pleochroic in browns, blues and bluish-green. Large and small zircons are present as inclusions, often ringed with pleochroic haloes. Biotite is nearly absent, and garnets, usually idioblastic, are likewise quite rare.

10-15% of the rock is quartz. Crystalloblasts are equidimensional (normally $\frac{1}{2}$ mm or less), but have irregular outlines. Fragments of hornblende, magnetite and feldspar are included in the larger grains.

Magnetite, usually associated with hornblende, is common as lensy masses. Zircon is also accessory.

Specimen No. A139/63

Field Name

Coarse-grained amphibolite.

Location

D.D. hole 832, North Mine ore, 240'

Macroscopic

Hornblende and feldspar are dominant mineral species. Both are coarse-grained, hornblende crystals often several mms in width. The texture is granoblastic, with no evidence of directional texture.

Microscopic

The amphibolite consists largely of plagioclase and hornblende. The grain size has increased considerably, and plagioclase becomes very abundant, quartz being deficient. These grains are usually xenoblastic, and the structure is granulose.

Magnetite is common both as minute inclusions in the hornblende and as larger masses. It frequently fills irregular fissures and cracks between and through other mineral grains. No garnet occurs.

Plagioclase is coarsely-twinned and has the composition of oligoclase. The maximum extinction angle in sections normal to 010 is $+15^{\circ}$. It is biaxial, negative, and $2V = 85^{\circ}$. This is the dominant feldspar, and 30-40% of the slide is plagioclase.

Hornblende, strongly pleochroic, is very abundant, and 55-60% is this mineral. Brown cones, indicative of a different composition, are common. Pleochroic haloes surround grains of included zircon. Apatite, particularly abundant, is of larger grain size than is usual for this accessory.



Figure 27 - Amphibolite.

Photograph X70 of A139/63 shows coarsely crystalline plagioclase and hornblende with accessory rounded apatite and scattered magnetite.

6. GRADATION FROM SILLIMANITE GNEISS TO
SERICITE SCHIST

<u>Thin Section</u>	<u>Description</u>
A139/100	garnet - sillimanite gneiss
A139/71	garnet - sillimanite - sericite schist.
A139/72	garnet - sillimanite - biotite - sericite gneiss.
A139/73	garnet - sericite schist.
A139/41	sericite schist.

This suite is a transition from sillimanite gneiss, with abundant almandine garnet, to sericite schist. It represents a sericitisation of sillimanite gneiss by a steady "making over" of essential minerals to sericite, biotite, and subsidiary chlorite. Thus sillimanite, feldspars and quartz have been rimmed by fine flakes of sericite, and the femic minerals like garnet and biotite have altered to chlorite, sericite and biotite. These changes are apparent from the following slide descriptions.

Specimen No. A139/100

Field Name

Garnet, biotite, sillimanite gneiss.

Location

D.D. hole 738, Zinc Corporation Ltd., core, 530'

Macroscopic

A soft gneiss composed of small flakes of black biotite, needle-like sillimanite, and pink elongated almandine garnets. Foliation is strongly developed, with parallel folia of biotite separated by thin streaks of sillimanite, quartz and minor feldspar. These layers are definite enough for the rock to be called a gneiss and not schist. The garnets are small, commonly 1/16" in diameter, and very abundant. They are somewhat stretched-out in the plane of foliation.

Microscopic

This is a coarsely crystalline rock composed of characteristic conspicuous garnets, bladed sillimanite, quartz, biotite and orthoclase. Long prisms of sillimanite and ragged flakes of biotite lie along the planes of schistosity. Pink almandine garnets are elongated along the schistosity. These are commonly 1/16" in diameter, but may be as large as 1/8". Layers of quartz and feldspar are poorly defined, and the rock may be called a schist, in the true sense of the word. Magnetite crystals are embedded in layer plates of biotite. Also in the biotite are found tiny zircons, characteristically rounded, and surrounded by pleochroic haloes. Chlorite is probably retrograde, as an alteration of biotite and garnet.

Quartz is not over-abundant, and the main bulk of the rock is composed of sillimanite, biotite and garnet. Most quartz crystals are crowded with inclusions. Outlines are very irregular and often poorly defined. Perhaps 5-10% of the rock is quartz.

Garnets are of the almandine variety. They are very numerous, and appear as large pink porphyroblasts set between folia of biotite. Long sillimanite blades have been pushed aside by garnets, and are wrapped around the latter. Alteration is evident, but not at all pronounced. Chlorite, light green and slightly pleochroic, is fairly common. Also, biotite is another product of this nature. The garnets contain myriads of fine sillimanite inclusions; quartz, biotite and orthoclase have also been included.

Feldspar are slightly sericitised, and as a result, somewhat cloudy. Orthoclase is the only one of importance, although a few grains of plagioclase occur. The latter shows no multiple twinning but optical properties suggest that it is rather sodic, in the oligoclase range. However, the potash feldspar is the dominant one. Less than 5% of the rock is orthoclase. No other feldspars were determined.

Accessory minerals are zircon, chlorite, magnetite and apatite. Magnetite is the most abundant of these. Small zircons are of the same relief as fragments of sillimanite, but the birefringence is considerably higher. Chlorite is an alteration of the biotite, rather than garnet. It is comparatively rare. Apatite is quite rare. A few well-formed crystals of characteristic outline and relief were found.

Specimen No. A139/71

Field Name

Garnet - sillimanite - sericite schist.

Location

D.D. hole 813, North Mine core, 220'

Macroscopic

The schist consists largely of layers of biotite, sericite and sillimanite and alternate siliceous bands. Garnets (often $\frac{1}{4}$ " wide) are abundant.

Microscopic

The rock is a garnet-biotite-sericite-sillimanite schist, with subordinate magnetite and plagioclase. A pronounced schistosity has been imparted by directed growth of sericite and biotite flakes along foliation planes, and an alignment of long prisms of sillimanite. Quartz crystalloblasts occur as definite layers or seams, with individuals slightly elongated in the plane of schistosity. Several crystals of quartz show undulose extinction.

Sillimanite needles have altered to fine-grained sericite. However, the alteration is apparently restricted to this mineral. Large garnet porphyroblasts contain numerous inclusions of xenomorphic quartz and biotite, but are only partially altered at the edges to chlorite and sericite of some interest is the poikiloblastic fabric of garnet and sillimanite. Minute idioblasts of the latter have been "caught up" in the larger, faster growing garnets. A rough alignment of these needles is still evident, paralleling the general foliation.

Feldspars are nearly entirely absent, apart from a minor occurrence of plagioclase remnants. These have been at most entirely sericitised. They are untwinned or show only a faint semblance to twinning. The composition was not determined.

Magnetite was the only accessory mineral determined. It is generally associated with dark brown biotite as small blebs of irregular shape.

Specimen No. A139/72

Field Name

Garnet-sillimanite-biotite-sericite gneiss.

Location

D.D. hole 813, North Mine core, 230'

Macroscopic

The rock is rather gneissic, with distinct banding due to layers of quartz and sericite. Large garnets are extremely fragmented.

Microscopic

The rock consists chiefly of quartz, plagioclase, biotite, sericite and garnet, with subordinate sillimanite and orthoclase. Zircon and apatite are accessories. It is more granulose than previous thin sections, and sericite - formation is not so strongly evident. The grain size is slightly smaller and garnets are rather fragmented, rather than granular and rounded. There is practically no marginal alteration to biotite.

Biotite is deficient and plagioclase more abundant in this rock. The feldspar is xenoblastic and shows good multiple twinning. With xenoblastic quartz and sericite grains it forms a poikiloblastic implication fabric. The composition is Ab_5An_5 . It is andesine, in the more calcic range. Other feldspars are rare. Orthoclase occurs only as relics - largely altered to wisps of sericite.

The rock is more siliceous than previous rocks of this suite. Grains of quartz are irregular in outline and often rimmed with sericite as though late reaction between active fluids and pre-formed quartz crystalloblasts had occurred. Many quartz grains show strain shadows and are elongated along planes of foliation. Small inclusions of quartz (not in optical continuity), feldspar and sericite are common. Average grain size for quartz xenoblasts is 0.5 mm.

The rock contains quite a strong development of sericite without producing any powerful foliation. The flakes are very tiny and unoriented in the plane of foliation. It is obvious that orthoclase has been converted almost entirely to sericite, the mass retaining the shape of the larger feldspar crystals.

Only a few isolated needles of sillimanite are present. Alteration to sericite has been nearly complete.

Accessory minerals are hard to find. Apatite occurs as a few large crystals of high relief. Zircon is restricted to isolated rounded grains in larger biotite flakes. They are marked by pleochroic haloes.

Specimen No. A139/73

Field Name

Garnet, sericite schist.

Location

D.D. hole 813, North mine core, 235'

Macroscopic

A schistose rock consisting largely of sericite, quartz and garnet. Garnets are pink almandine, and characteristically sheared out in the plane of schistosity.

Microscopic

This is a quartz-sericite schist. Foliation is strongly developed, and is largely due to oriented flakes of sericite. Quartz is the dominant mineral, with subordinate biotite and sericite. Segregations of magnetite are aligned, parallel to the schistosity. No feldspar is present.

Quartz grains are minute (0.5 mm or less). They are xenoblastic and elongated along foliation planes. Undulose extinction is characteristic of many grains.

Garnet is present as large sheared-out porphyroblasts. It is the variety almandine, and is largely altered to biotite.

Accessory minerals are zircon and apatite.

Specimen No. A139/41

Field Name

Sericite schist.

Location

D.D. hole E2, Delprat, 712'

Macroscopic

A highly schistose rock composed of fine-grained sericite interlayered with sheets of quartz-feldspar. Biotite is also present, although not to the same extent as sericite. Again, the flakes are very small. Pink garnets, probably almandine, are disseminated between planes of schistosity. These are somewhat elongate, and usually fragmented with irregular outlines. Grain diameters vary, but the maximum would be less than $\frac{1}{8}$ ", with most about $\frac{1}{16}$ ". Quartz and feldspar layers are contorted, and the structure is suggestive of ptigmatic folding. An estimate of the percentage quartz is difficult, but it would be fairly low - perhaps 30%. No large grains occur. The same applies to feldspar.

Microscopic

The rock is a sericite, garnet, quartz, with a conspicuous foliation mainly due to aligned flakes of fine-grained muscovite (sericite) and subordinate biotite. Quartz xenoblasts are characteristically elongated or sheared-out along the plane of foliation. A fine layering is apparent, with streaks of interlocked sericite flakes separated by trains of polygonal quartz grains. Large almandine porphyroblasts are abundant. These have altered marginally to biotite, and a minor development of small blebs of magnetite, closely associated with the biotite. Magnetite is an abundant constituent throughout; also, small segregations may occur. Fine elongated splinters follow the trend of micas.

Feldspars are of little importance. Plagioclase is present as xenoblasts of about the same size as the quartz (2 mm commonly). It is a rare constituent. Grains are unaltered and coarsely twinned. Twinning, however, is not at all clear. The composition is that of andesine. Orthoclase is entirely absent, and no potash feldspar of any nature was determined. All of the potash of the rock is held by sericite and biotite.

Quartz grains are of irregular shape, usually elongated or flattened. Inclusions, too small to be determined, are plentiful in some areas, but not consistently present. Overall grain size is small, but most grains are 0.2 mms wide, with larger ones less abundant.

Garnets may be several mms wide. These contain inclusions of quartz grains, swept into the nucleus during rapid growth. Alteration has occurred, but is not intense. Segregations of small garnets along schistosity planes are common. These minute grains, frequently disconnected, are completely fresh and unaltered.

Biotite flakes are small, and strongly pleochroic from yellow to brown. They are of the same dimensions as flakes of sericite, the dominant species of this schist. Preferred orientation is pronounced. Zircon inclusions are very small, but high relief and strong birefringence provide an easy basis for recognition. Chlorite, showing anomalous interference colours is an associated of biotite, probably as a retrograde alteration of the latter.

TRANSITION FROM POTOSI GNEISS TO SILLIMANITE GNEISS

Thin Section

Description

A139/100	garnet, biotite, sillimanite gneiss
A139/101	siliceous garnet, biotite gneiss
A139/102	siliceous sillimanite, biotite, garnet gneiss.
A139/103	feldspathic garnet, biotite gneiss
A139/104	garnet, plagioclase granulite.

Garnet, biotite, sillimanite gneiss is often intimately associated with Potosi Gneiss, and it was thought that the Potosi-like gneisses may have been the result of spasmodic pegmatization of sillimanite gneiss horizons. Boundaries between the two gneisses are indistinct and gradational, and the following thin sections represent stages of what was considered to be a "making over" of the sillimanite gneiss into the more feldspathic Potosi Gneiss. Hand specimens of diamond drill core bring out the following points:←

1. Quartz and feldspar increase steadily, until a maximum is reached in the Potosi Gneiss.
2. Sillimanite steadily decreases.
3. Garnets become larger as the rock becomes more feldspathic.
4. The biotite content is fairly constant throughout. Slides A139/100, 101, 102, 103 and 104 are typical of such a gradation. A139/100 is the usual garnet, sillimanite, biotite gneiss, composed largely of black biotite and long needles of sillimanite, visible in the hand specimen. Garnets are small, poorly-formed, but very abundant, and feldspar and quartz are not plentiful. Both 101 and 102 show a noticeable increase in silica, but sillimanite streaks are still prominent. These have changed partially to sericite, again observable in the hand specimen. 103 shows a considerable increase in both silica and feldspar, and a decrease in biotite and sillimanite. Garnets are still rather shapeless, but much larger in diameter. The rock is not what might be called a typical Potosi Gneiss because it still retains a coarse gneissose structure made more apparent by streaks of sericite, probably as an alteration of sillimanite. 104 is Potosi Gneiss proper. It is a feldspathic garnet, biotite gneiss, with large pink granular garnets rimmed with black biotite. Sillimanite is rare, and not apparent in the hand specimen.

The suite A139/15, 16, 17, 18 and 20 has also been included in this section. It illustrates a similar transition, with the exception that A139/20 is a sillimanite, biotite gneiss with no garnet.

These two suites both show a very good gradation between the above-mentioned rock types.

Specimen No. A139/100

Field Name

Garnet, biotite, sillimanite gneiss.

Location

D.D. hole 738, Zinc Corporation Ltd., core, 530'

Macroscopic

A soft gneiss composed of small flakes of black biotite, needle-like sillimanite, and pink elongated almandine garnets. Foliation is strongly developed, with parallel folia of biotite separated by thin streaks of sillimanite, quartz and minor feldspar. These layers are definite enough for the rock to be called a gneiss and not schist. The garnets are small, commonly 1/16" in diameter, and very abundant. They are somewhat stretched-out in the plane of foliation.

Microscopic

This is a coarsely crystalline rock composed of characteristic conspicuous garnets, bladed sillimanite, quartz, biotite and orthoclase. Long prisms of sillimanite and ragged flakes of biotite lie along the planes of schistosity. Pink almandine garnets are elongated along the schistosity. These are commonly 1/16" in diameter, but may be as large as 1/8". Layers of quartz and feldspar are poorly defined, and the rock may be called a schist, in the true sense of the word. Magnetite crystals are embedded in larger plates of biotite. Also in the biotite are found tiny zircons, characteristically rounded, and surrounded by pleochroic haloes. Chlorite is probably retrograde, as an alteration of biotite and garnet.

Quartz is not over-abundant, and the main bulk of the rock is composed of sillimanite, biotite and garnet. Most quartz crystals are crowded with inclusions. Outlines are very irregular and often poorly defined. Perhaps 5-10% of the rock is quartz.

Garnets are of the almandine variety. They are very numerous and appears as large pink porphyroblasts set between folia of biotite. Long sillimanite blades have been pushed aside by garnets, and are wrapped around the latter. Alteration is evident, but not at all pronounced. Chlorite, light green and slightly pleochroic, is fairly common. Also, biotite is another product of this nature. The garnets contain myriads of fine sillimanite inclusions; quartz, biotite and orthoclase have also been included.

Feldspar are slightly sericitised, and as a result, somewhat cloudy. Orthoclase is the only one of importance, although a few grains of plagioclase occur. The latter shows no multiple twinning but optical properties suggest that it is rather sodic, in the oligoclase range. However, the potash feldspar is the dominant one. Less than 5% of the rock is orthoclase. No other feldspars were determined.

Accessory minerals are zircon, chlorite, magnetite and apatite. Magnetite is the most abundant of these. Small zircons are of the same relief as fragments of sillimanite, but the birefringence is considerably higher. Chlorite is an alteration of the biotite, rather than garnet. It is comparatively rare. Apatite is quite rare. A few well-formed crystals of characteristic, outline and relief were found

Specimen No. A139/101

Field Name

Siliceous garnet, biotite gneiss.

Location

D.D. hole 738, Zinc Corp. Ltd., 530'

Macroscopic

The rock contains orthoclase, quartz, garnet and biotite, with subordinate sillimanite. Structure is coarsely gneissic, although bands of biotite folia are widely spaced. Garnets are poorly-formed and appear to have altered partially to biotite. They are numerous, and of small grain diameter (approximately 1/16"). Quartz has a bluish-grey tinge, but there are few large grains present. Fine bands of quartz and feldspars are separated by biotite streaks. A polished rock face indicates that this rock has been severely sericitised. This mineral has undoubtedly replaced sillimanite threads, but also occurs around other mineral grains such as quartz and feldspar.

Microscopic

The main constituent minerals are sillimanite, garnet, biotite, orthoclase and quartz. Plagioclase crystals are poorly twinned and, in any case, fairly rare. Magnetite, sericite, zircon and apatite are also noteworthy. The structure is gneissose, and bands of biotite and sillimanite are separated by lenticles of quartz and orthoclase. Sericitisation is notably weak, with but a minor development outlining quartz and feldspar grains. Sillimanite does not appear to be altering to sericite.

Quartz grains are irregular in shape, and contain minute inclusions. These inclusions are small flakes of biotite and sericite, needles of sillimanite, crystals of zircon, and fragments of quartz grains not in optical continuity with the enclosing crystal. Often the larger quartz xenoblasts are cracked and exhibit undulose extinction. Elongation in the plane of foliation is well-marked. Perhaps 25-30% of the rock is quartz.

Sillimanite is very abundant, and occurs as fine idioblasts of high relief. A strongly developed preferred orientation is apparent, parallel to biotite flakes, and intimately associated with these. Sillimanite is unaltered. Smaller needles are found as inclusions in large garnet porphyroblasts, and in quartz grains. 30% of the thin section would be sillimanite.

Orthoclase xenoblasts are more abundant than plagioclase. The former mineral has altered slightly to sericite at the edges and along cracks and cleavages. 5-10% of the rock is feldspar. No microcline occurs. Almandine garnets are often 2 mms in diameter. Sections are rather poorly-formed and somewhat fractured. These fractures are filled with biotite and chlorite, and less commonly with sericite, as alteration products of the garnet. Inclusions of rounded quartz grains and of minute flakes of mica and needles of sillimanite are plentiful.

Fine magnetite particles rim the larger flakes of biotite. Magnetite masses are fairly irregular in crystal form but they are not abundant in the matrix. Zircon, apatite, and chlorite (mentioned in a reference to garnet) are relatively sparse.

Specimen No. A139/102

Field Name

Siliceous sillimanite, biotite, garnet gneiss

Location

D.D. hole 738, Zinc Corp. Ltd., core, 530'

Macroscopic

The rock is a garnet, biotite gneiss with a well-developed gneissic structure. Quartz is abundant, and is of a translucent blue colour. The siliceous nature of the rock is apparent, with but a minor amount of feldspar present. Sericitisation is widespread, and long streaks, possibly containing relic sillimanite needles occur throughout. Garnets are small, usually 1/16" in diameter, and are characteristically elongated in the plane of foliation. Biotite is fairly abundant, and appears as thin folia, imparting a banded appearance on the rock. No sulphides were detected in the hand specimen.

Microscopic

The gneiss is composed of quartz, sericite, garnet, biotite and sillimanite, with subordinate orthoclase. A strong directional texture is apparent, with long streaks of wispy sericite discernible even in the hand specimen. Plates of dark brown biotite and long prisms of sillimanite show a preferred orientation. Small almandine garnets of irregular outline are quite numerous. These have been slightly altered to the micas, biotite and sericite and to chlorite. Feldspars are rare, and sericitisation has been extensive, with decomposition of orthoclase to sericite. Relics of orthoclase have been examined, but sillimanite has also altered partially.

Inclusions of quartz, flakes of biotite, and minute wisps of sericite are common in the larger almandine porphyroblasts. These are usually about 2 mm in diameter, but may be slightly larger.

Biotite is plentiful, and is a dark brown, strongly pleochroic variety, frequently containing small blebs of magnetite. Zircon is a common associate, and is ringed by characteristic pleochroic haloes.

Quartz grains are often specked by small inclusions and have very irregular grain outlines, accentuated by sericite rimming. The latter is fine-grained. Individual flakes are ragged and apparently randomly oriented. At least 30% of the slide is sericite, with 20% quartz.

Zircon and magnetite are minerals of lesser importance.

Specimen No. A139/103

Field Name

Feldspathic garnet, biotite gneiss.

Location

D.D. hole 738, Zinc Corp. Ltd., core, 530'.

Macroscopic

This is a coarser-grained pegmatitic gneiss with abundant quartz, feldspar and garnet, and subordinate biotite. The quartz is distinctly blue, more so than is the case with 101 and 102. It is also of much coarser grain size. Feldspar is abundant, and aggregates of sericite suggest some alteration. Garnets are large, and have changed to biotite, and possibly sericite. They are very irregular in shape, and usually about $\frac{1}{8}$ " in diameter, with larger ones reaching $\frac{1}{4}$ ". Biotite and sillimanite are not abundant, with the latter probably largely altered to sericite.

Microscopic

The rock is composed largely of quartz, orthoclase, garnet, biotite and sericite, and has a roughly gneissose structure. Grain size is fairly coarse, with quartz grains often several mms wide, and pink almandine garnets often $\frac{1}{4}$ " in diameter. Sillimanite is not present at all. Sericitisation is rather intense, and orthoclase, in particular, has changed almost completely to sericite. In accordance with the increased overall grain size, the sericite has appeared to "merge", forming larger flakes surrounded by smaller ones.

Garnets are numerous. These have very irregular outlines and contain many quartz grain inclusions. Alteration to biotite has occurred, but is not everywhere pronounced.

Biotite flakes are large in most cases, but aggregates of smaller plates also occur. It is pleochroic from yellow brown to dark brown, with no reddish-brown tinge. Zircon is a common inclusion. Magnetite, fairly rare, is also associated with biotite.

Quartz crystals are xenoblastic. The outlines are often marked by sericite streaks. Small inclusions are plentiful. In some places a peculiar texture has developed, where quartz of varying orientation seems to act as a cement between large quartz grains. 30-35% of the rock is quartz.

TRANSITION FROM GARNET, PLAGIOCLASE

GRANULITE TO SILLIMANITE GNEISS.

<u>Thin Section</u>	<u>Description</u>
Al39/15	garnet, feldspar, quartz granulite
Al39/16	siliceous garnet, feldspar granulite
Al39/17	Potosi gneiss.
Al39/18	sericitised biotite granulite.
Al39/20	sillimanite, biotite, sericite, gneiss.

The only variation in this suite is that of the sillimanite gneiss, which is garnet-deficient. All intermediates between garnet-sillimanite gneiss (with abundant garnet) and biotite-sillimanite gneiss (with no garnet) have been examined at Broken Hill. Al39/20 is a rock containing no garnet. This grades into Potosi Gneiss "C" (Al39/15), and the above suite represents "stages" in the transition. The contact is not sharp, but is marked by feldspar-quartz-garnet veining (see Al39/64 in next section) suggestive of an intense feldspathisation or pegmatisation of the sillimanite gneiss. Sericitisation both of Potosi Gneiss and sillimanite gneiss is pronounced, although more extensive within the sillimanite gneiss. Sillimanite and orthoclase (in Potosi "C") has partially altered to sericite.

Specimen No. A139/15

Field Name

Garnet, feldspar, quartz granulite.

Locality

D.D. hole 805, Delprat cross-section 1029'

Macroscopic

A silicious garnet granulite with a poorly-defined foliation imparted by aligned flakes of biotite. Garnets are rounded and generally unaltered, although a polished surface reveals some sericitisation at the edges. Blue quartz is abundant, but there are no traces of mineralisation. Feldspars have been sericitised.

Microscopic

A quartz, orthoclase, garnet, biotite gneiss which possesses a faint directional texture. Long streaks of sericite and small, ragged flakes of biotite are set in a granoblastic matrix of quartz and minor feldspar. Plagioclase is rare, but several finely-twinning xenoblasts are present. Garnets are small, usually 1/16" in diameter, and slightly altered to biotite and sericite. Sericitisation is intense, and all feldspars show signs of alteration. Several large inclusions of sericite are present within plagioclase grains.

Biotite is not abundant, and most flakes are small. Inclusions of magnetite are common. Biotite is a strongly pleochroic from light brown to dark brown, with no reddish tinge.

Plagioclase is biaxial, positive, and has a high 2V. The maximum extinction angle normal to O10 is 30°. It is labradorite, Ab₅An₅. 5% or less, of this rock is plagioclase. Orthoclase is more abundant, but the rock as a whole is very silicious, and feldspars are subordinate in amount.

Well-rounded crystals of zircon, and small colourless apatite plates are rare. Magnetite (or ilmenite) is also accessory.

Grain size is very variable, but more quartz crystals average 1/2 mm in diameter. Large porphyroblasts also occur.

Specimen No. A139/16

Field Name

Silicious garnet, feldspar granulite.

Location

D.D. hole 805, Delprat cross-section, 1054'

Macroscopic

This rock is very similar to A139/15, with the possible difference lying in degree of sericitisation. Long streaks of sericite parallel the faint directional texture caused by aligned biotite. A fresh surface shows sugary patches, which probably represent partially altered feldspars.

Microscopic

The mineralogy is essentially the same as A139/15, but a few points are worthy of mention.

Sericitisation is pronounced, feldspars having altered almost completely to sericite. Interstices of quartz fractures in large garnet porphyroblasts have been filled by sericite flakes.

Biotite occurs as aggregates of small flakes rather than as large individual plates. Pleochroism is strong, from light yellow brown to dark brown.

Grain size is variable, but the rock is largely fine-grained. Larger quartz xenoblasts show signs of strain, with undulose extinction. Garnets are normally $\frac{1}{8}$ " in diameter, and frequently contain quartz inclusions.

Magnetite, zircon and apatite are rare.

Specimen No. A139/17

Field Name

Potosi Gneiss (rather poor)

Location

D.D. hole 805, Delprat core, 1078'

Macroscopic

This is a gneissic quartzite, consisting mainly of quartz, garnet, biotite and feldspar. It is very massive and hard, and has an uneven fracture. Quartz is the dominant mineral, with very few large grains and an overall tendency towards a fine-grained nature. Garnets are likewise very small. They are associated with biotite. Sericite is apparently abundant as long streaks and between quartz grains.

Microscopic

The rock consists chiefly of quartz, garnet, feldspar, biotite and sericite, with subordinate magnetite and accessory apatite and zircon. The silicious matrix is granoblastic, but aligned flakes of biotite, and streaks of sericite have produced a faint foliation. Feldspars are fairly rare, but both plagioclase and orthoclase are present. Garnets are small, and altered peripherally and along fractures.

There is little difference in mineralogy between A139/17 and the preceding members of the series. Textures and the relative proportions of essential minerals are of importance, however. Biotite content has increased, and foliation is more pronounced. Grain size is similar, but as far as shapes are concerned, grains in 17 are noticeably equidimensional. Quartz xenoblasts are not elongated, but several show undulose extinction.

Specimen No. A139/18

Field Name

Sericitised biotite granulite.

Location

D.D. hole 805, Delprat core, 1080'

Macroscopic

The rock is a slightly sericitised, biotite-rich quartzite. Folia of biotite, and associated sericite give the rock a well-banded appearance in certain parts. These folia "flow" around large masses of siliceous material. Garnet is abundant, but very fine-grained and irregularly distributed. The rock is an excellent intermediate between a Potosi-like gneiss and sillimanite gneiss.

Microscopic

The rock is a hotch-potch of small ragged flakes of biotite and sericite, with prismatic sillimanite, in a matrix of porphyroblastic quartz and feldspar. These porphyroblasts are very irregular in shape, and the inclusions are completely randomly oriented. Sillimanite abounds as long needles of high relief, associated with wisps of sericite and larger flakes of brown biotite. Garnets are small and idioblastic. Slight alteration to sericite has occurred. The composition is almandine.

Biotite flakes show a strong preferred orientation and are often slightly altered to sericite at the edges. A fairly abundant accessory, often, associated with biotite is magnetite. This occurs as elongate segregations along with sillimanite, biotite, sericite masses.

Zircon and apatite are rare.



Figure 28 - Sericitised biotite granulite.

Fine needles of sillimanite altering to sericite are visible in this photograph of A139/18. (X70). Crystals of garnet, biotite, quartz and magnetite are also obvious.

Specimen No. A139/20

Field Name

. Sillimanite, biotite, sericite gneiss.

Location

D.D. hole 805, Delprat core, 1105'

Macroscopic

The rock consists largely of biotite, sillimanite, sericite and quartz. Texture is gneissic, with bands of biotite rich material separated by masses of quartz and extremely fine-grained sericite. No garnet is present. Fractures are not clean because of a disjointed foliation, and the rock would be better classified as a gneiss, rather than schist. No plagioclase or orthoclase could be seen with a hard lens.

Microscopic

The chief minerals present are sillimanite biotite, sericite, quartz and magnetite. Quartz grains are elongated in the plane of schistosity. Sillimanite and biotite exhibit strong preferred orientation. The formed also occurs as small needles-like inclusions in the larger quartz grains, randomly distributed therein. Magnetite segregations are arranged linearly in the plane of schistosity.

Only 20% of the rock is quartz grains are xenoblastic and often elongated. Fractures are at right angles to the long axis.

The most abundant mineral is sericite. Biotite is slightly less plentiful, as is also sillimanite. The latter has been severely sericitised.

Zircon is the only accessory mineral. Grain size is variable but quartz grains are commonly $\frac{1}{2}$ mm wide. Biotite flakes are much larger, often several mms. long. Sericite is very fine-grained, with most individual flakes only a fraction of a mm long.

FELDSPATHIC GARNET QUARTZITE A139/64

This rock was representative of coarse-grained pegmatitic vein material which is extremely widely distributed at Broken Hill. It often occurs at contacts of pseudo-Potosi Gneiss and sillimanite gneiss (mentioned in the previous suite) and is suggestive of a metasomatic feldspathisation either of sillimanite gneiss or of some other interbedded material (e.g. quartzite). The alternation, visible in the hand specimen, of pegmatitic material, rich in almandine garnets, with layers of feldspathic sillimanite-biotite-garnet gneiss was studied in thin section here. A139/64 was cut at an angle of approximately 45° to the foliation, so that vein material and sillimanite gneiss bands (quite thin) could be studied in the same rock section. The description follows:

Specimen No. A139/64

Field Name

Feldspar, garnet quartzite.

Location

D.D. hole 832, North Mine, 560'

Macroscopic

The length of core shows alterations of thinly bedded quartzite with more biotite-rich gneissic material. Large pink granular garnets are characteristic of the siliceous bands. Very little garnet occurs in association with the biotite. The quartzite is siliceous, but no blue quartz is present. Feldspar is subordinate, garnet plentiful, and biotite absent.

Microscopic

Quartzite with Potosi Gneiss - like veinlets. This slide may be divided into two sections; the first a biotite-rich quartzite, with subordinate and garnet, and the second zone of vein material (essentially quartz, feldspar and garnet). Both potash feldspar and plagioclase occur. Plagioclase is well-twinned and unaltered. Orthoclase xenoblasts however are commonly altered to sericite at the edges.

Vein plagioclase is andesine and has a maximum extinction angle normal to 010 of $+20^\circ$. It is biaxial positive. The rock contains from 5 to 10% of plagioclase. Sericite frequently occurs as small unoriented flakes at the edges of plagioclase, orthoclase and quartz grains. Both quartz and feldspar crystals are xenoblastic.

Biotite is sparse, but the rocks contains occasional flakes showing distinct light brown to reddish brown pleochroism. Most flakes contain magnetite inclusions.

Large pink porphyroblastic are quite fresh, but often contain rounded quartz grains as inclusions.

Sillimanite occurs as occasional scattered needles, but increases in content as the biotite zone is approached. There is no distinct boundary between the two zones, but grain size decreases and biotite increases rapidly from vein to quartzitic material. Long fibres of sillimanite cause a distinctive foliation to appear. Sericite also increases.

Magnetite is rare in both sections, but for an occasional large grain. It is more likely ilmenite.

Zircon is a common accessory. Grains are rounded, oval in shape, and rarely show crystal edges.

Garnet, sillimanite, biotite gneiss A139/66

This rock, typical of the garnet-sillimanite gneisses, was closely associated with A139/64 from D.D. 832, North Mine. No feldspar is present, but the rock has suffered sericitisation, with introduction of potash and subsequent alteration of sillimanite at the edges.

Specimen No. A139/66

Field Name

Garnet, sillimanite, biotite gneiss

Location

D.D. hole 832, North Mine, 560'

Macroscopic

A coarsely gneissic rock composed chiefly of streaks of sillimanite, large altered almandine garnets, knotted masses of biotite and plentiful fine-grained sericite. It is typical of the garnet, sillimanite gneisses.

Microscopic

A garnet, sillimanite gneiss. Both needle-like sillimanite and abundant fine-grained sericite occur in the same rock. Quartz is present as xenoblasts of irregular shape and variable size. Sericite is very abundant as an alteration of orthoclase and sillimanite. Flakes are very small and individually unoriented, although the mass as a whole parallels the plane of foliation. Needles and prisms of sillimanite are associated with sericite, plainly altering to the latter. They are common also as fine hair-like inclusions in large pink garnets. The garnets are somewhat altered to biotite at the edges, and occur as large irregular porphyroblasts. Biotite flakes are strongly pleochroic from light brown to reddish brown. Inclusions of zircon have produced numerous pleochroic halos. Biotite may be changing to sericite, with release of tiny magnetite particles.

The rock contains no plagioclase, and orthoclase has probably altered to sericite. The texture shows a strong tendency towards schistosity. Foliation is marked by parallel alignment of sericite masses, long sillimanite prisms, and flakes of biotite.

APPENDIX

SPECIMEN LOCATIONS ON CROSS - SECTIONS

"AA", "BB", AND "CC".

CROSS-SECTIONS

"AA"

Imperial Ridge

Hanging Wall Gneiss "A"	surface outcrops
Hanging Wall Gneiss "B"	D.D. 830 G 30'-1020' 836 1132'-1470' 827H 866'-959'
Potosi Gneiss "A"	surface outcrops
Potosi Gneiss "B"	D.D. 819 625' 670' (two locations)

"BB"

Delprat Shaft

Hanging Wall Gneiss "A"	D.D. E1 1729'-1800' E2 1811'-2194' E3 1380'-1453' W1 1748'-2000'
Hanging Wall Gneiss "B"	not on cross-section
Potosi Gneiss "A"	D.D. E1 600'-789' E2 435'-548' E3 783'-820'
Potosi Gneiss "B"	D.D. 805 498'-608' 771 440'-560' 691 190'-220'
Potosi Gneiss "C"	D.D. 777 0 - 87' 783 0 - 89' 805 950 - 1080'

"CC"

Zinc Corporation Ltd. (Freeman's Shaft)

Hanging Wall Gneiss "A"	D.D. 631 827' - 1058' also from surface outcrop.
Hanging Wall Gneiss "B"	D.D. 296 1475' - 2004'
Potosi Gneiss "A"	surface outcrops
Potosi Gneiss "B"	D.D. 1152 460'-485' 1240 710'-785' surface outcrop at Rising Sun North.
Potosi Gneiss "C"	D.D. 1152 974'-1000' 1240 1360'-1407'

Imperial Ridge Cross-Section "AA"

DB Hole	Depth (Feet)	Specimen No.	Description
816	1000	55	Banging Wall Gneiss "5"
819	540	56	Potomac Gneiss "B"
819	660	57	" " (not typical)
		58	Banging Wall Gneiss "B"
432	360	59	Verisite schist.
"	"	60	" " with feldspar-quartz veins.
"	"	61	" " with inclusions of verisite.
"	"	62	Slightly amphibolized verisite-biotite schist.
"	"	63	Amphibolite.
812	500	64	Feldspathic gneiss, with Potomac garnet-like minerals.
		65	garnet sillimanite schist.
		66	intermediate between garnet-biotite-sillimanite gneiss and verisite schist.
		67	" "
834	100	68	steeped Banging Wall Gneiss "5"
834	1200	69	Banging Wall Gneiss "B"
834	800	70	intermediate of garnet-like gneiss to verisite schist, with muscovite.
815	250	71	change from garnet-sillimanite-biotite gneiss to verisite schist.
"	to	72	
"		73	70 and 71 are regarded as end limits to the series.
"	650	74	
816	720	75	Potomac Gneiss "B"
821	760	76	" " "
"		77	Potomac Gneiss.
"		78	amphibolized Potomac Gneiss.
"		79	Verisite (garnet-feldspar amphibolite)
"		80	amphibolite.
830	540	81	Banging Wall Gneiss "B"
"		82	" " " " (not typical)
827	780	83	" " " "
"		84	" " " "
"		85	" " " "
surface		86	" " " "
surface		87	Potomac Gneiss "A"
"		88	Potomac Gneiss "A"
"		89	Banging Wall Gneiss "A"
"		90	" " " "

CROSS SECTION SPECIMEN LOCATIONS

Rock Groups:

- 59-63 Verisite schist - amphibolite gradation, (including 60 and 61) sillimanite grains changing to verisite schist.
- 71-74 Potomac Gneiss gradually amphibolized.

Delprat Cross-Section, "BB"

D.D. Hole	Depth (ft.)	Specimen No.	Description
E3	810 - 811	1	Potosi Gneiss "A"
E2	614	2	" " "
E3	486	3	" " "
W1	863	4	" " "
E3	1971	5	Hanging Wall Gneiss "A"
E1	1781	6	" " "
E2	2060	7	" " " (more feldspathic than usual).
W1	1782	8	Hanging Wall Gneiss "A"
799	1054	9	Potosi Gneiss "B"
805	535	10	" " " (containing more sillimanite than usual).
771	462	11	Potosi Gneiss "B"
		12	(rejected)
681	178	13	Potosi Gneiss "B" (not typical)
691	195-197	14	" " "
805	1029	15	Potosi Gneiss "C"
805	1054	16	" " " with more sillimanite
805	1078	17	Potosi Gneiss "C" slightly greater sillimanite content.
805	1080	18	" " "
805	1086	19	feldspathic garnet sillimanite gneiss
805	1105	20	garnet biotite sillimanite gneiss
783	57	21	Potosi Gneiss "C"
783	37	22	" " " containing more biotite than 21.
777	46	23	Potosi Gneiss "C"
738	369	24	Potosi Gneiss "C"
738	375	25	" " " with more sillimanite and biotite.
738	377	26	feldspathic garnet biotite sillimanite gneiss.
738	384	27	Garnet biotite sillimanite gneiss.
E1	304	28	Slightly amphibolitised. Hanging wall Gneiss (rather magnetite-rich).
E1	307	29	" with more amphibole.
E1	316	30	" " " "
E1	340	31	feldspathic amphibolite.
E1	298-299	32	A contact between coarse-grained amphibolite and Hanging Wall Gneiss.
E3	642	33	Potosi Gneiss
E3	648	34	" " slightly amphibolitised
E3	656	35	feldspathic amphibolite.

D.D. Hole	Depth (ft.)	Specimen No.	Description
E3	669	36	Amphibolite
E2	2079	37	Hanging Wall Gneiss
E2	2079½	38	" " " with amphibolite devel.
E2	2080	39	Amphibolitised granitic gneiss.
E2	2081	40	Amphibolite
E2	712	41	Sericite schist.
E2	704	42	Feldspathic sericite schist.
E2	701	43	" "
E2	686	44	gradational contact rock-types
E2	681	45	" " "
E2	679	46	" " "
E2	678	47	amphibolitised rock.
E2	677	48	amphibolite.
W1	261	49	Gradation from amphibolite to pegmatitic vein material.
W1	261	50	Amphibolitised rock.
E2	423	51	Banded iron formation.
E2	424	52	(quartz-magnetite-garnet rock).
E2	425	53	feldspathised.
E2	434	54	Granitic gneiss with magnetite.
road cutting		85	Hanging Wall Gneiss "B"

Rock suites:

15-20	Potosi Gneiss changing to garnet-biotite-sillimanite gneiss.
24-27	" " etc.
28-32	Shows gradual amphibolitisation.
33-36	Potosi-Gneiss = amphibolite contact.
37-40	Transition from Hanging Wall Gneiss to amphibolite.
41-48	Gradation between sericite schist and amphibolite.
51-54	Contact of B.I.F. and granitic gneiss.

Zinc Corporation Cross-section "CC"

D.D. Hole	Depth (ft.)	Specimen No.	Description
631	880	91	Hanging Wall Gneiss "A"
296	1950	92	" " " "B"
631	784	93	Potosi Gneiss "A"
1240	795	94	Potosi Gneiss "B"
1152	975	95	Potosi Gneiss "C"
1152	480	96	Potosi Gneiss "B"
		97	" " "
surface outcrop		98	Potosi Gneiss "C" Rising Sun North.
		99	Potosi Gneiss "B", Rising Sun North.
738	530	100	Gradation between garnet- sillimanite -
		101	biotite gneiss and Potosi Gneiss.
		102	"
		103	"
		104	"
738		105	vein material
		106	" "
		107	garnet sillimanite gneiss.
		108	" " " (more feldspathic)
		109	" " "
		110	" " "
691	185-190	111	Sericite schist grading into Potosi Gneiss.
		112	(contact)
		113	"
		114	"
		115	Quartzite, with feldspar haloes around pink garnets.
783	366	116	Aplitic quartzite from lode below 10 level, Delprat.
759	159	117	"
681	615	118	"
Laurel 2	331	119	Aplite,
859	2	120	Aplite, in lode, 22 level, South Mine.
861	117	121	Aplite, in "pegmatite", just beyond lode 22/1 South Mine.
surface		122	Aplite, Great Vugh area (not average)
outcrop		123	Thackaringa aplite.
"		124	Pinnacles aplite.
"		125	Pinnacles aplite.
etc.		126	Big Hill aplite.
		127	Big Hill aplite.
		128	Aplite, 12 level, No. 7 shaft, South Mine.

ZINC Corpn. Cross-Section "CC"

<u>D.D. Hole</u>	<u>Depth (ft.)</u>	<u>Specimen No.</u>	<u>Description</u>
		129	Aplite, 12 level, No. 7 Shaft, South Mine.
		130	Redan aplite.
		131	"
		132	"
		133	"